

PRODUCT CODE: 10.110.320

prefabase
Quick Build Solutions

Instructions and User Guide

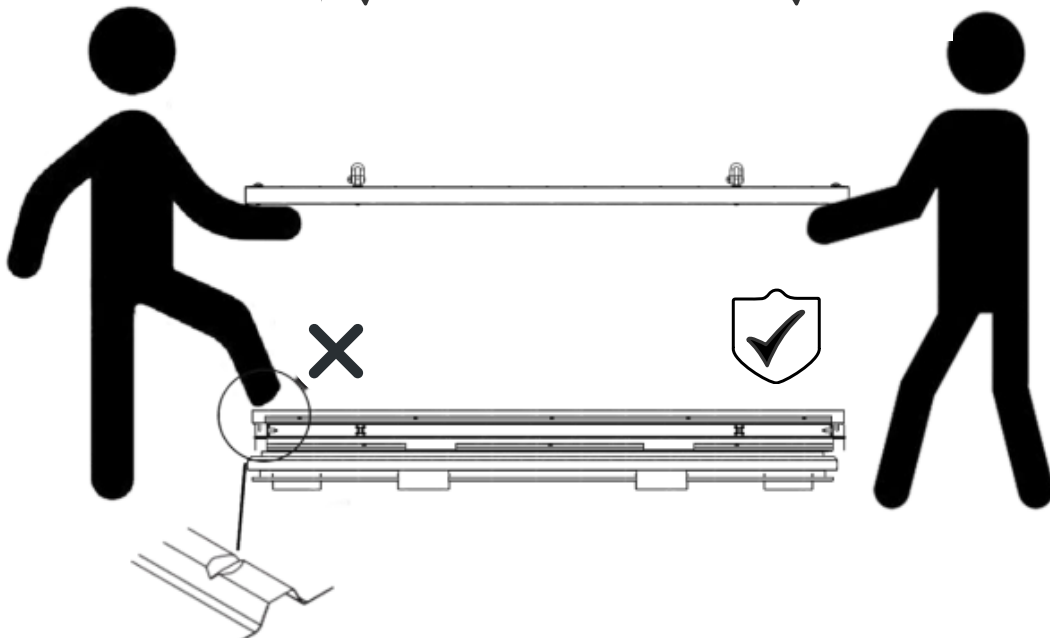
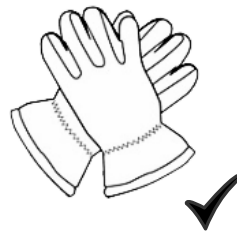

10.0110
1x

10.0510
1x

10.0410
2x

0310
1x

0320
1x

61.101
4x

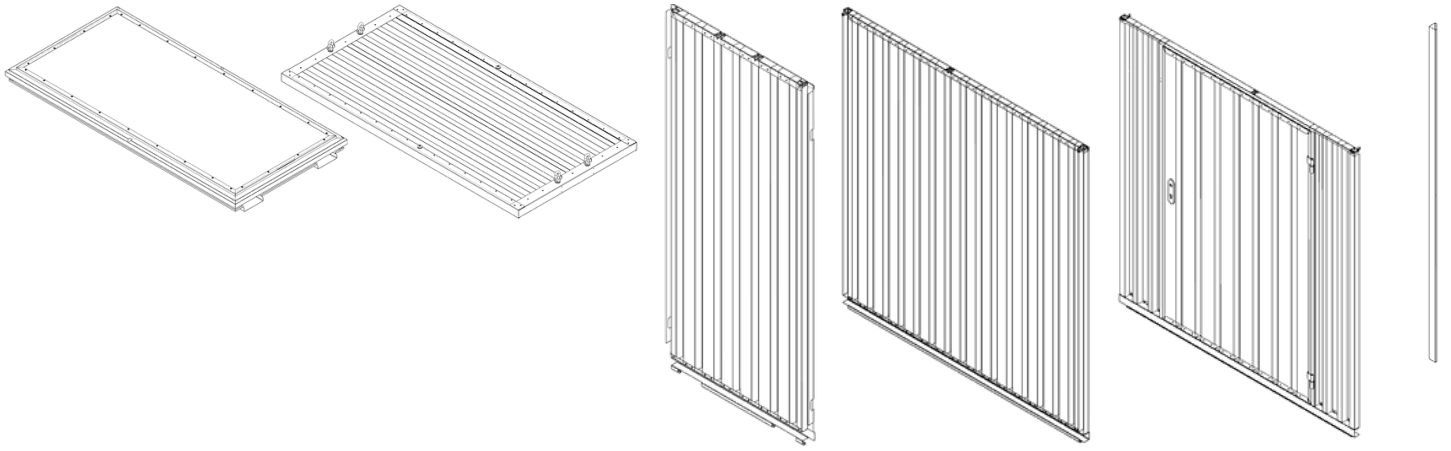

10x

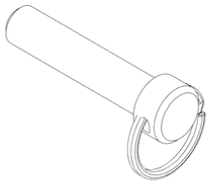

1x

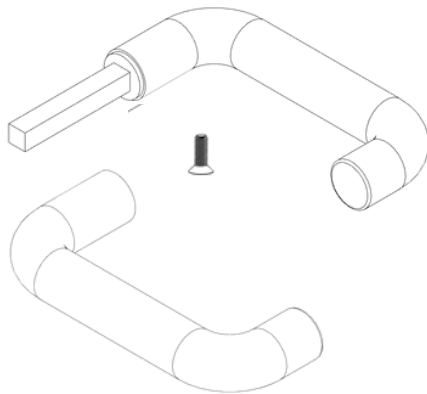

1x

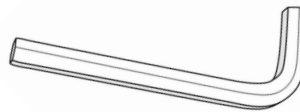

1x



1

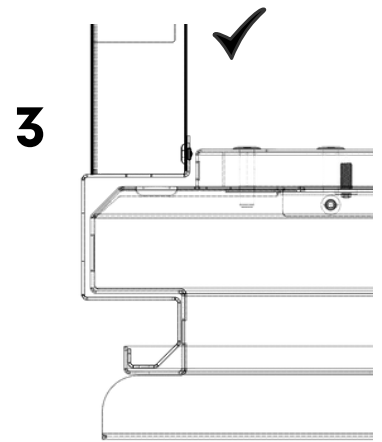
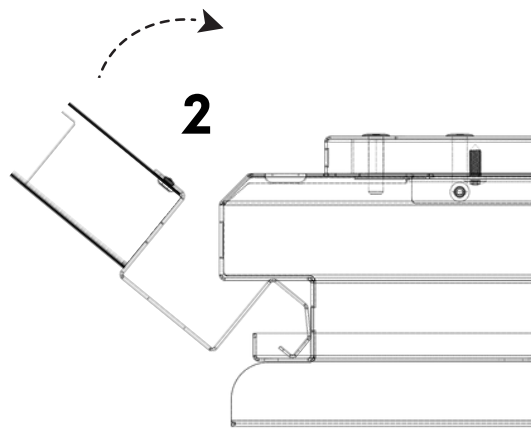
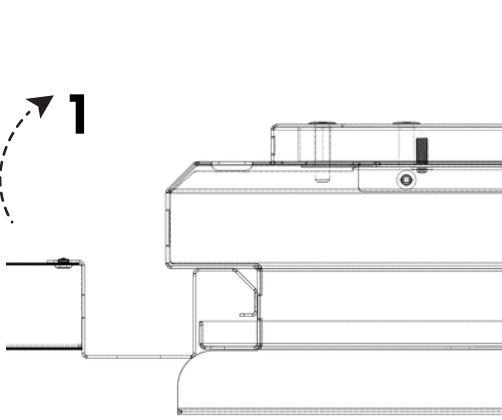
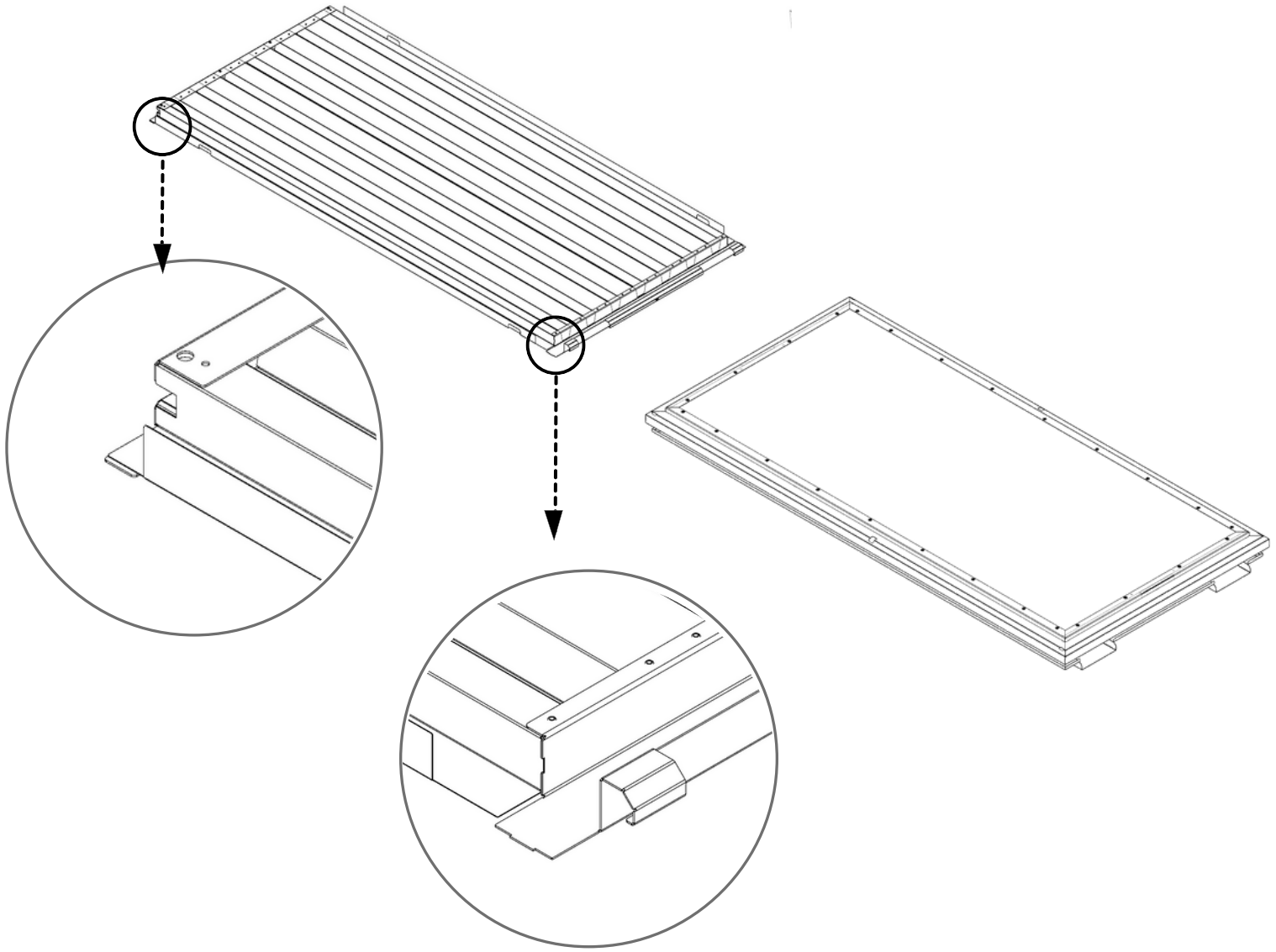

2

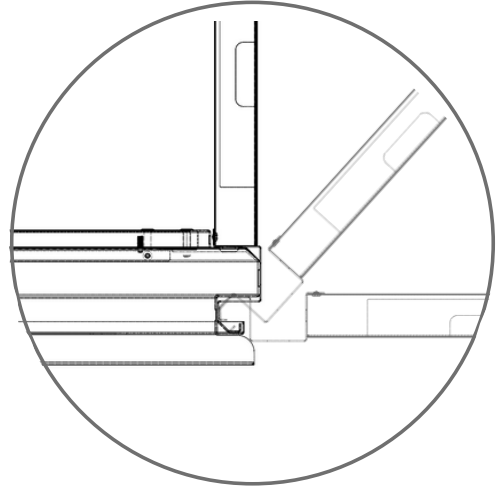
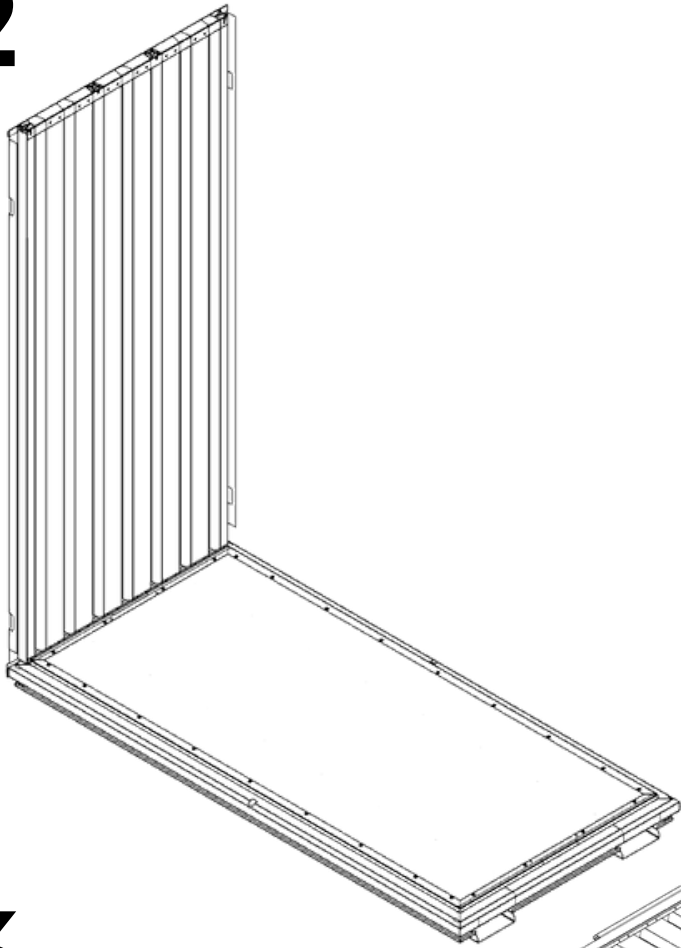

3

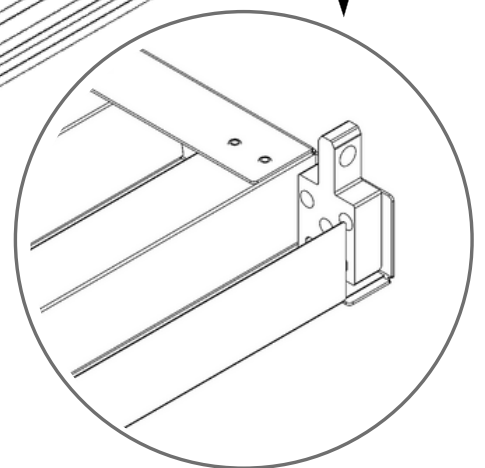
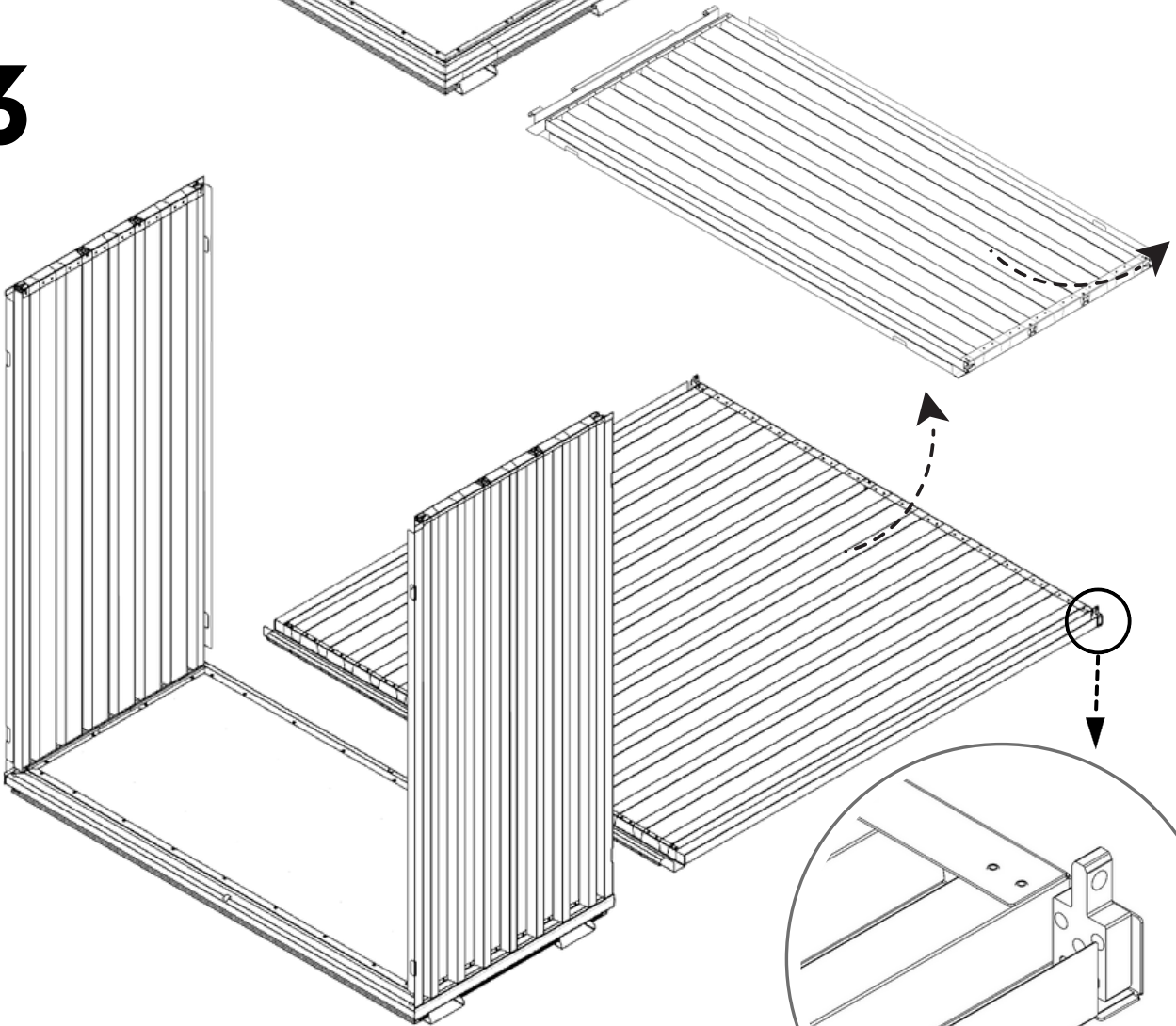

3.1

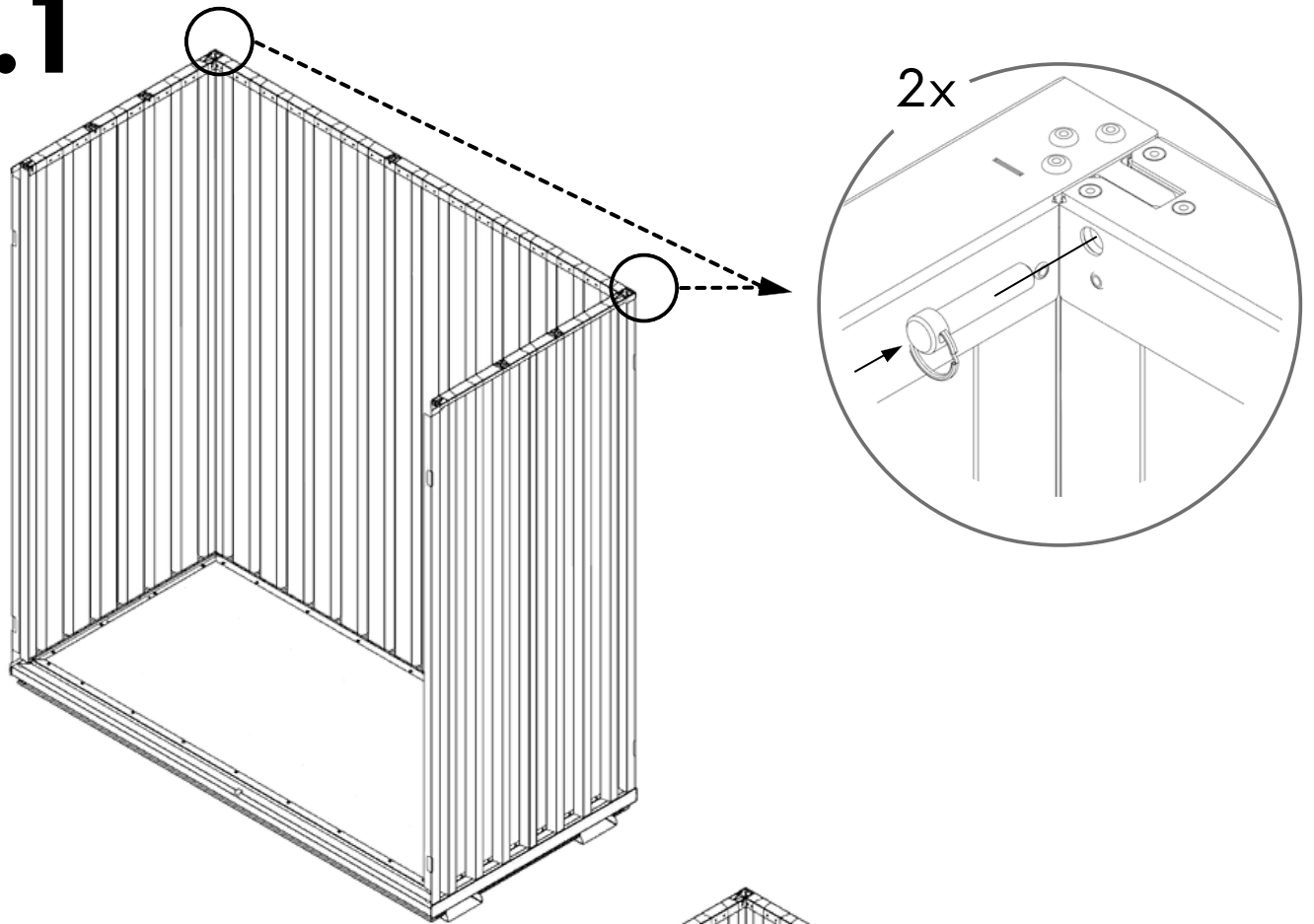

4

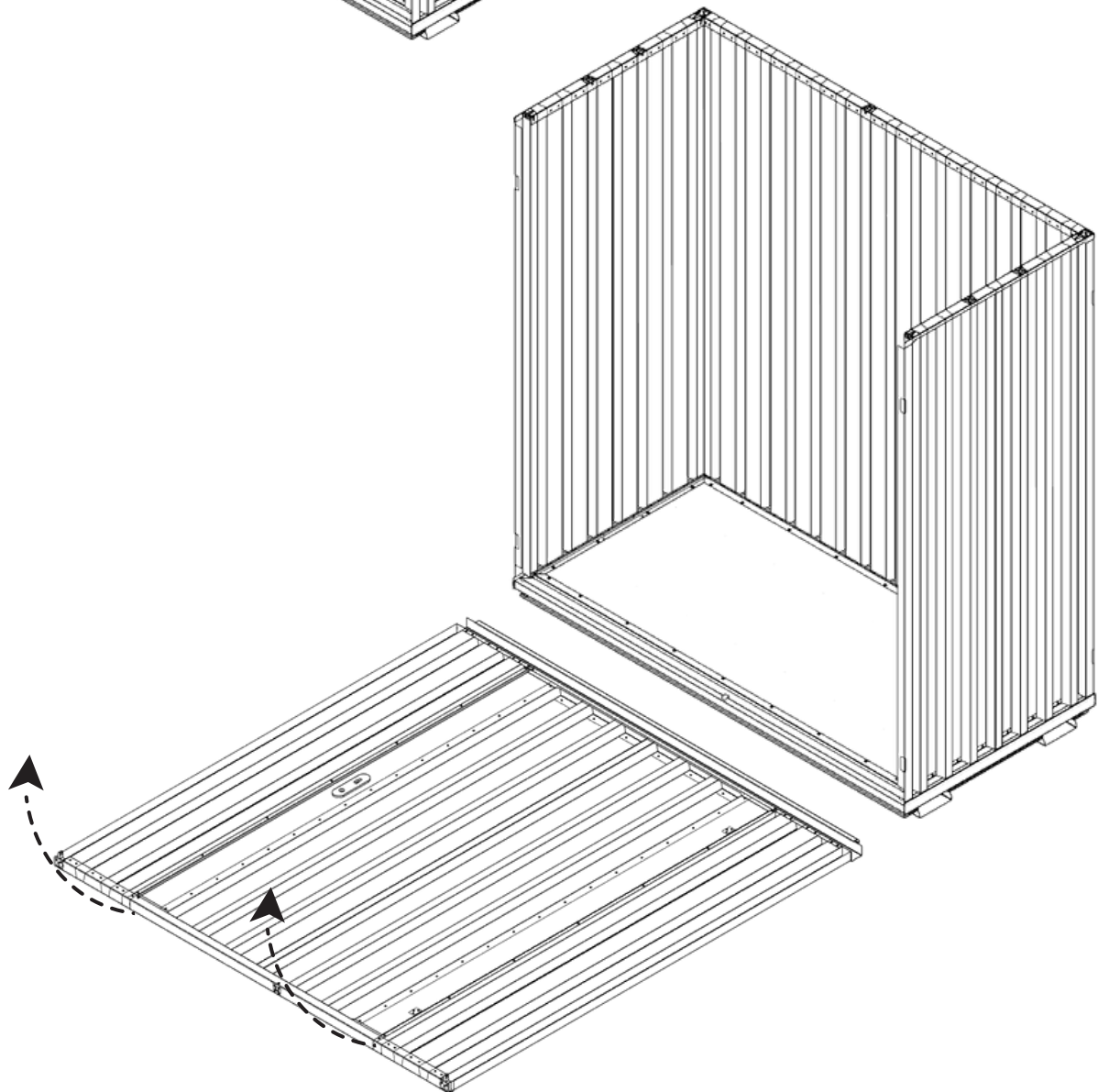

4.1

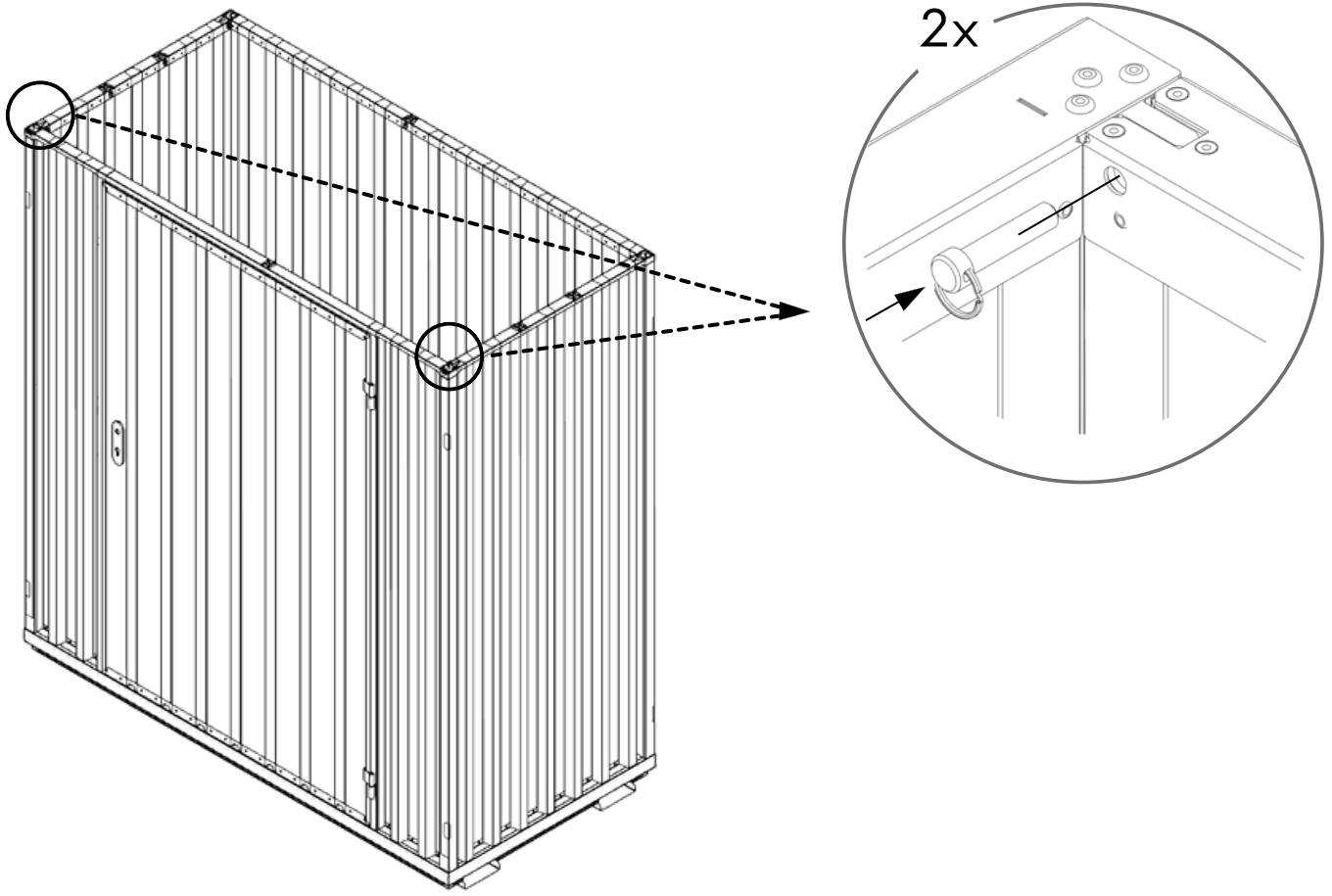

 180 KG	 1640 MM	Model Code: 10.110.320 Production Tracking Code:/X09.1.10.320    9001 14001 50001	 	
---	--	--	---	---

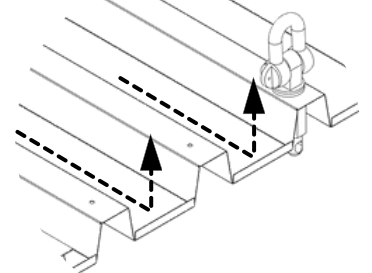
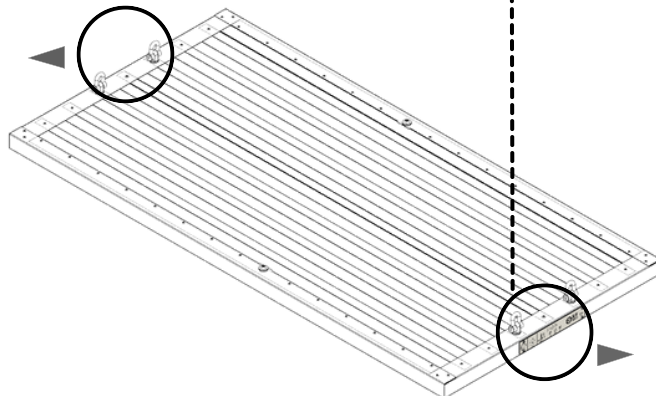
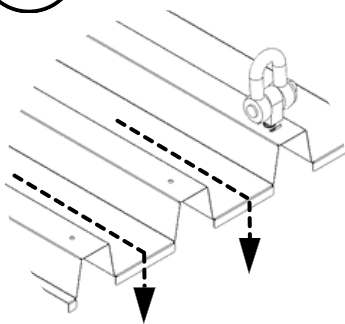

5

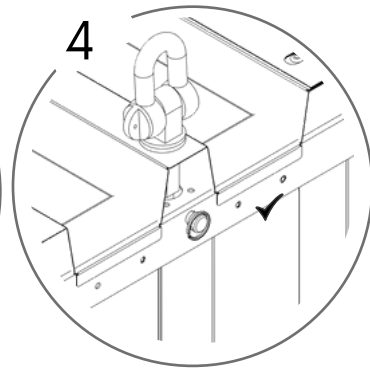
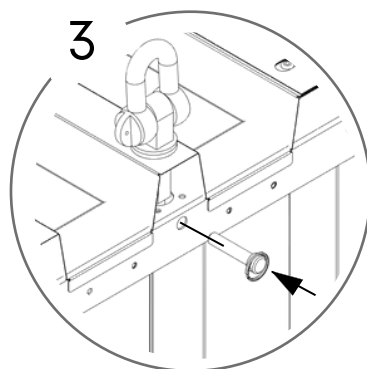
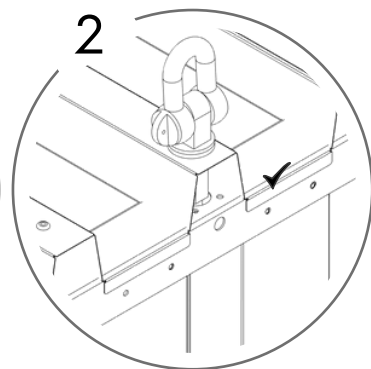
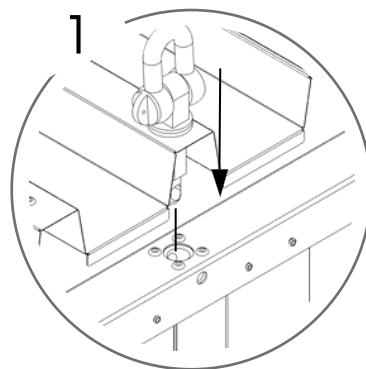
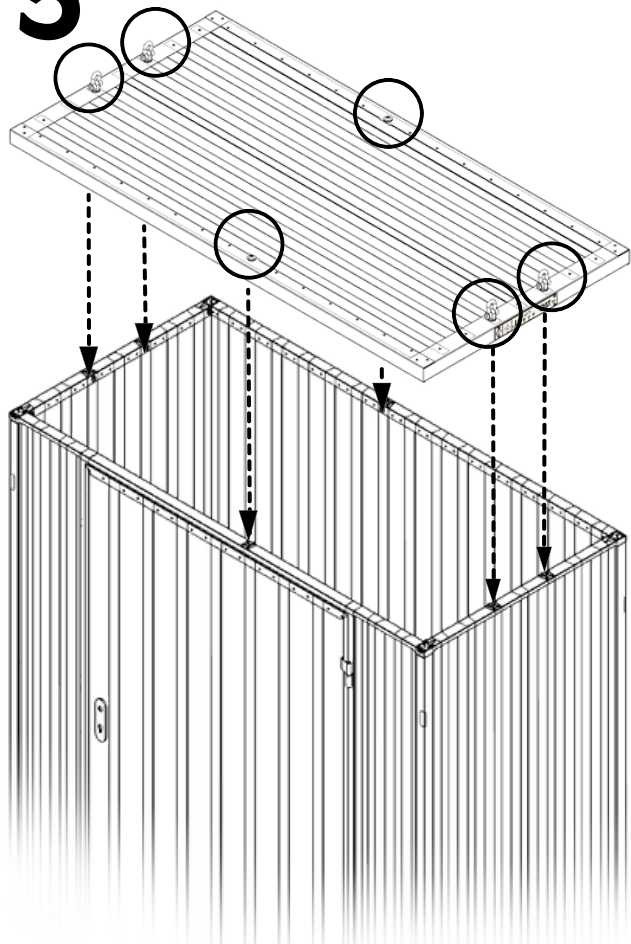

6

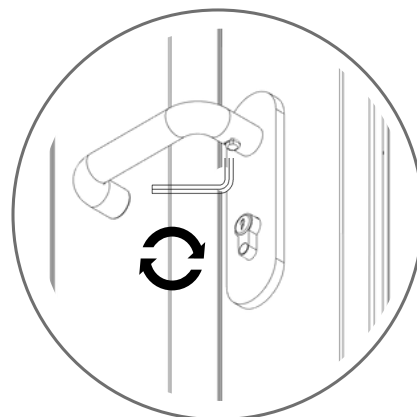
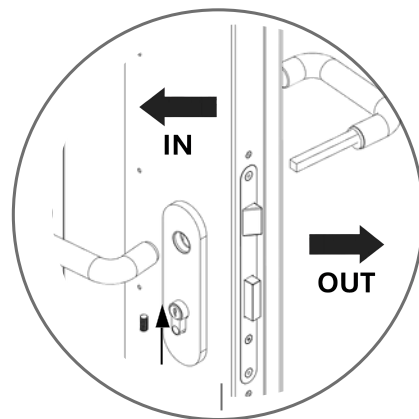
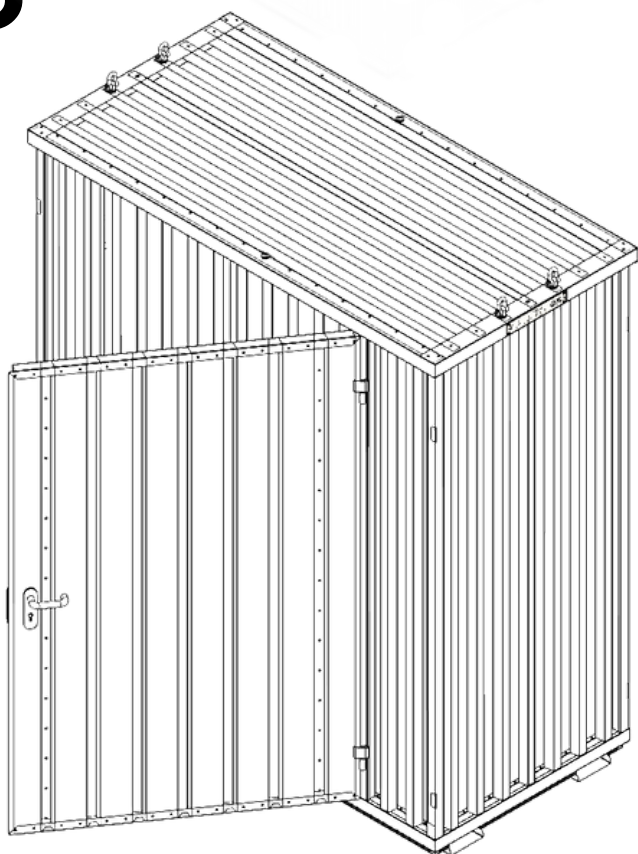

7

