

PRODUCT CODE: 4040.110.440

prefabase
Quick Build Solutions

Instructions and User Guide

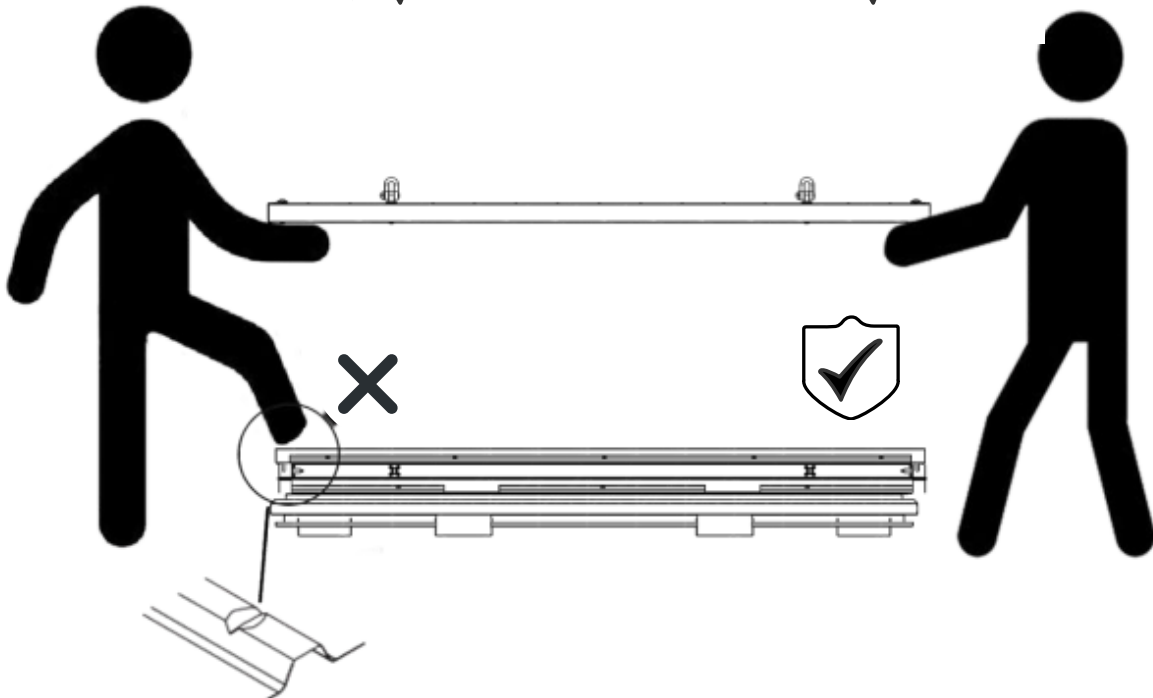
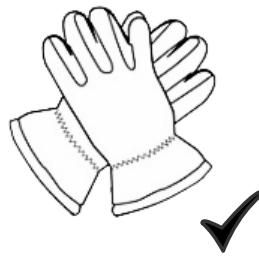

40.0110
2x

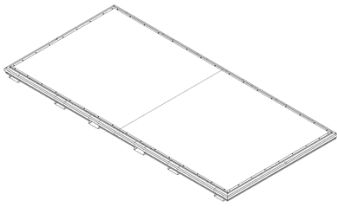

40.0510
2x

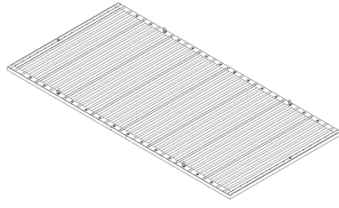

306.0110
1x



306.0510
1x



40.0410
3x

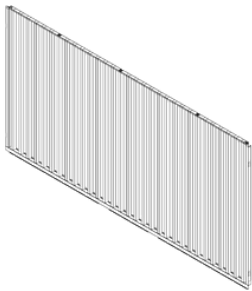

40.0440
1x

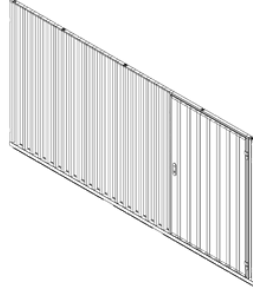

0310
2x

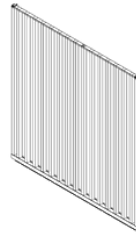

306.40.05
2x



306.40.04
2x



61.101
4x



24x

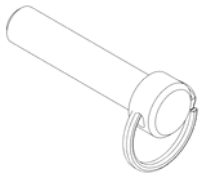

1x

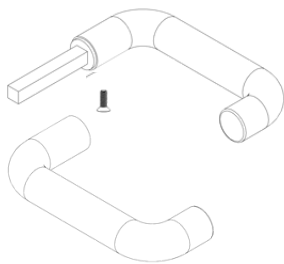

10x



10x



10x



1x



1x



1

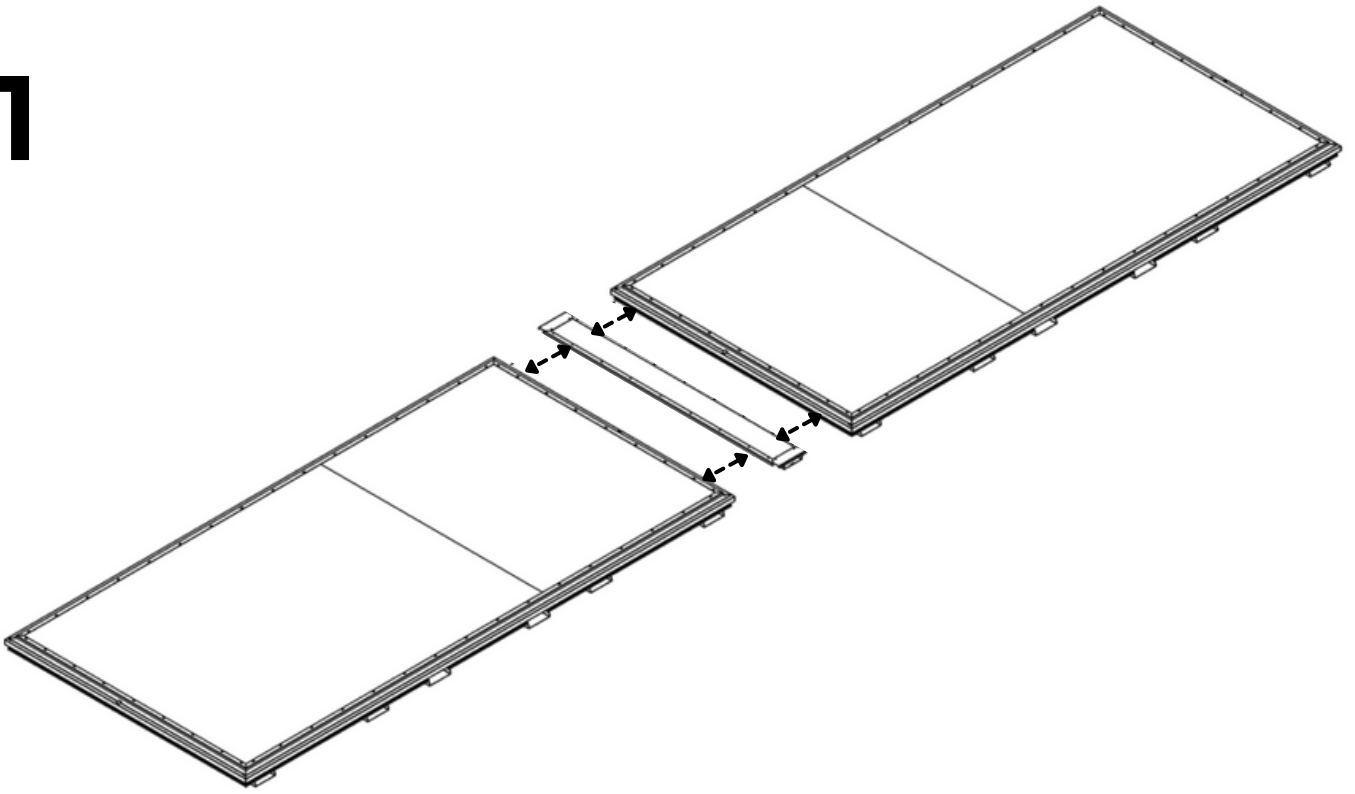

2

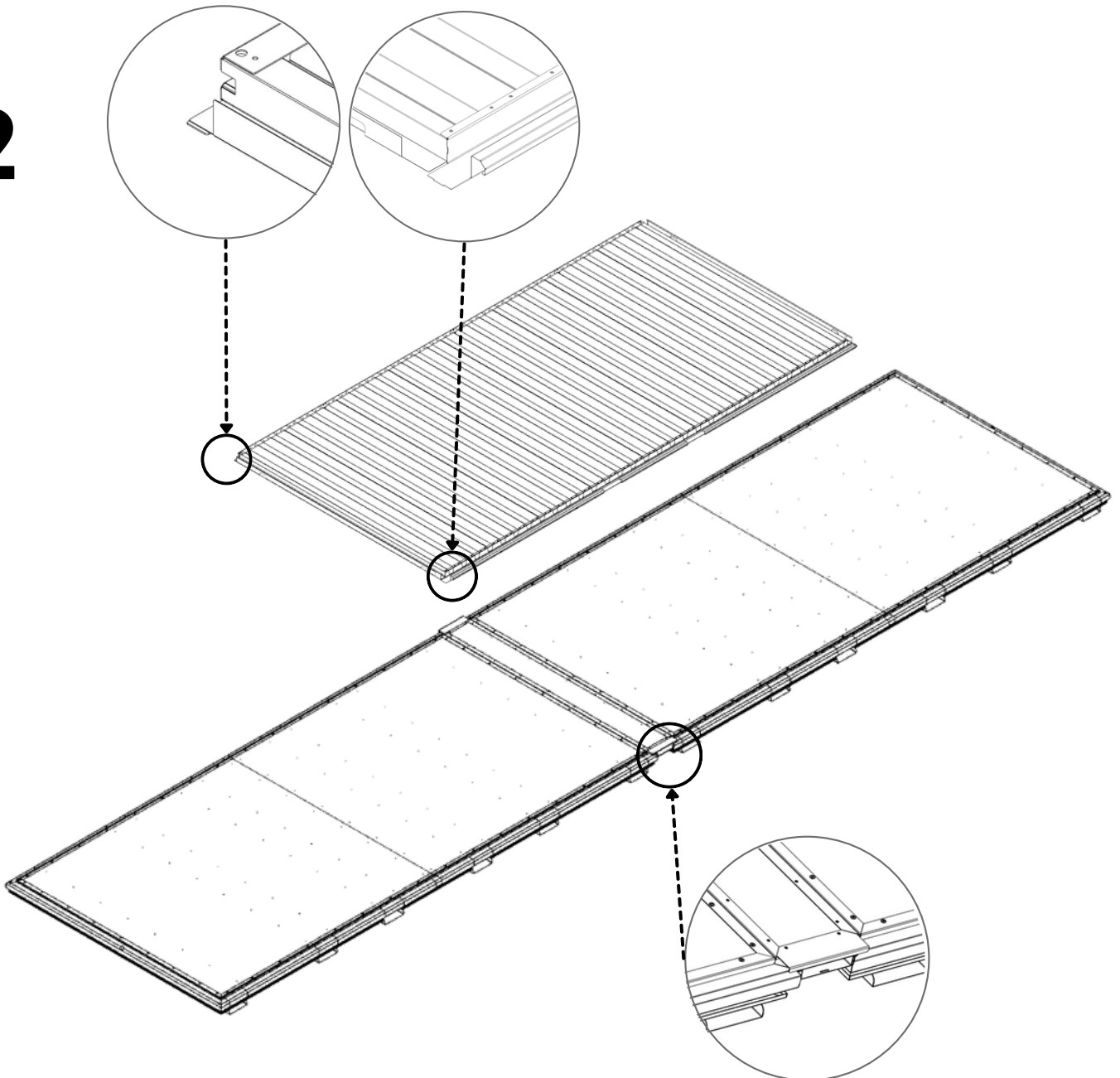

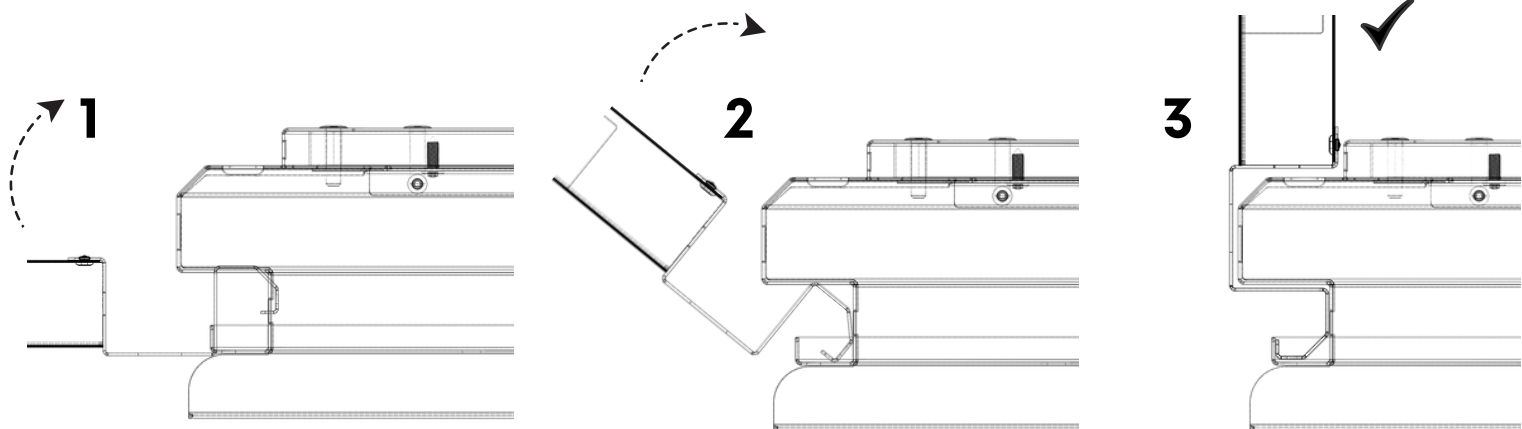

3

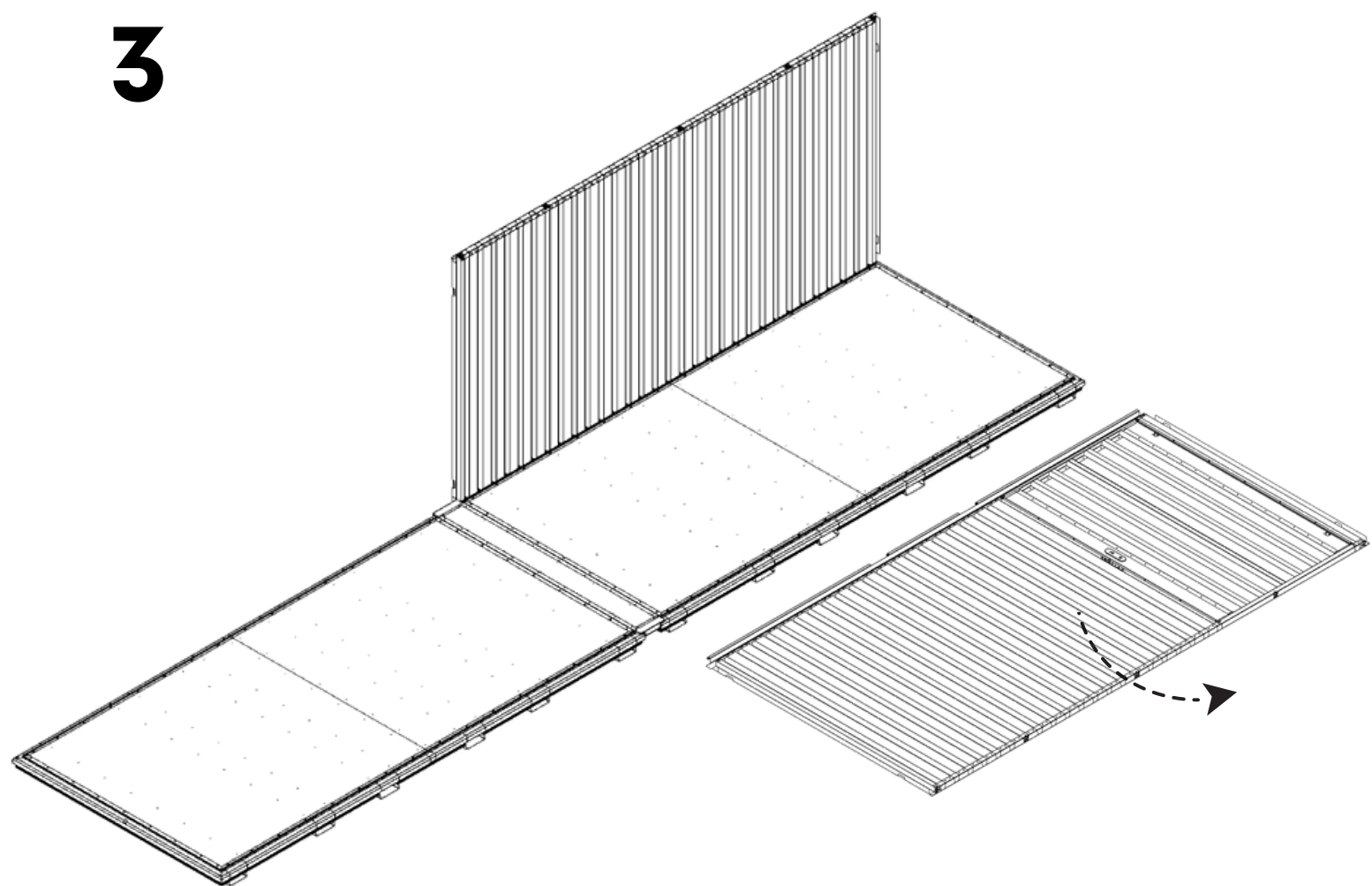

4

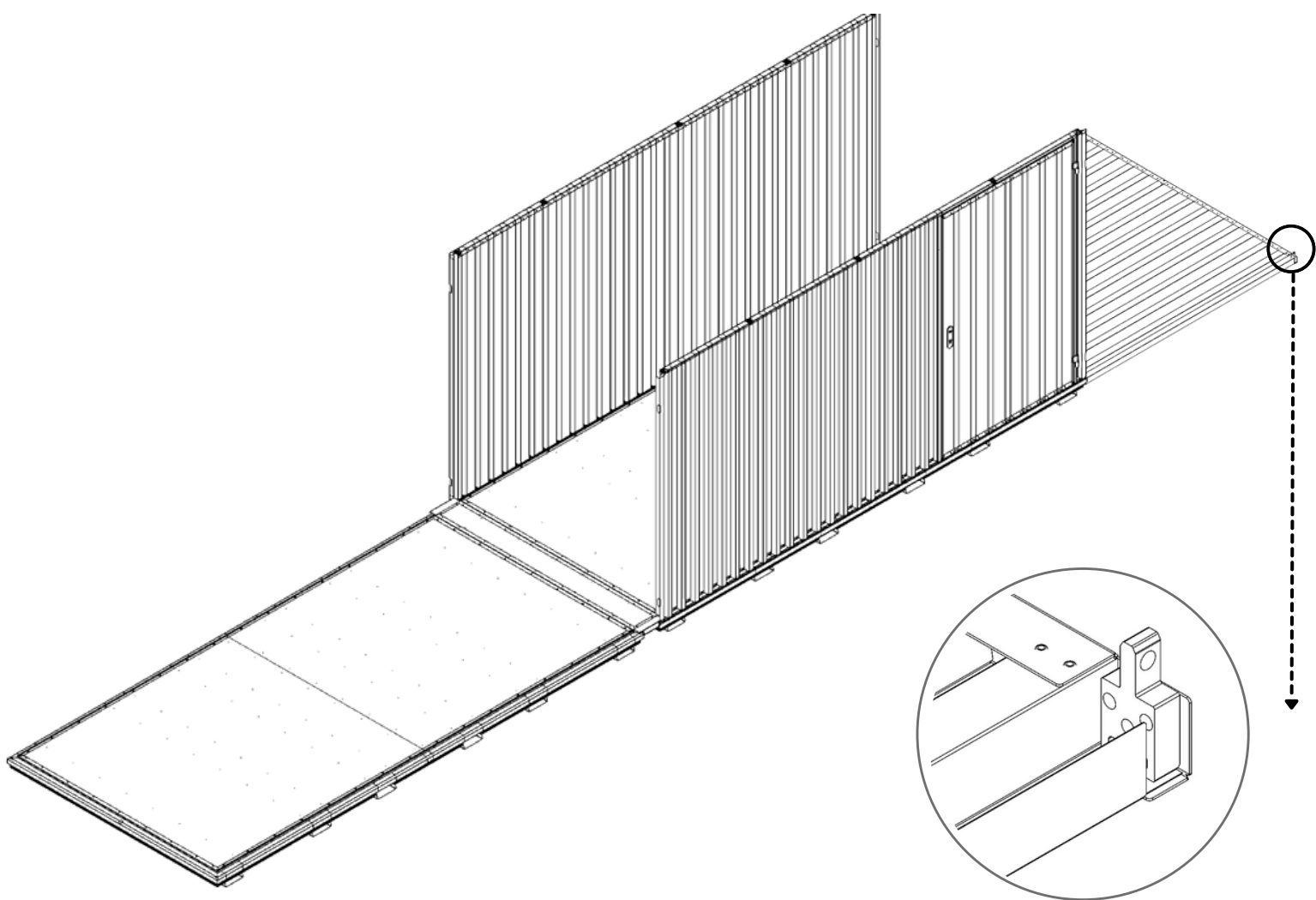

4.1

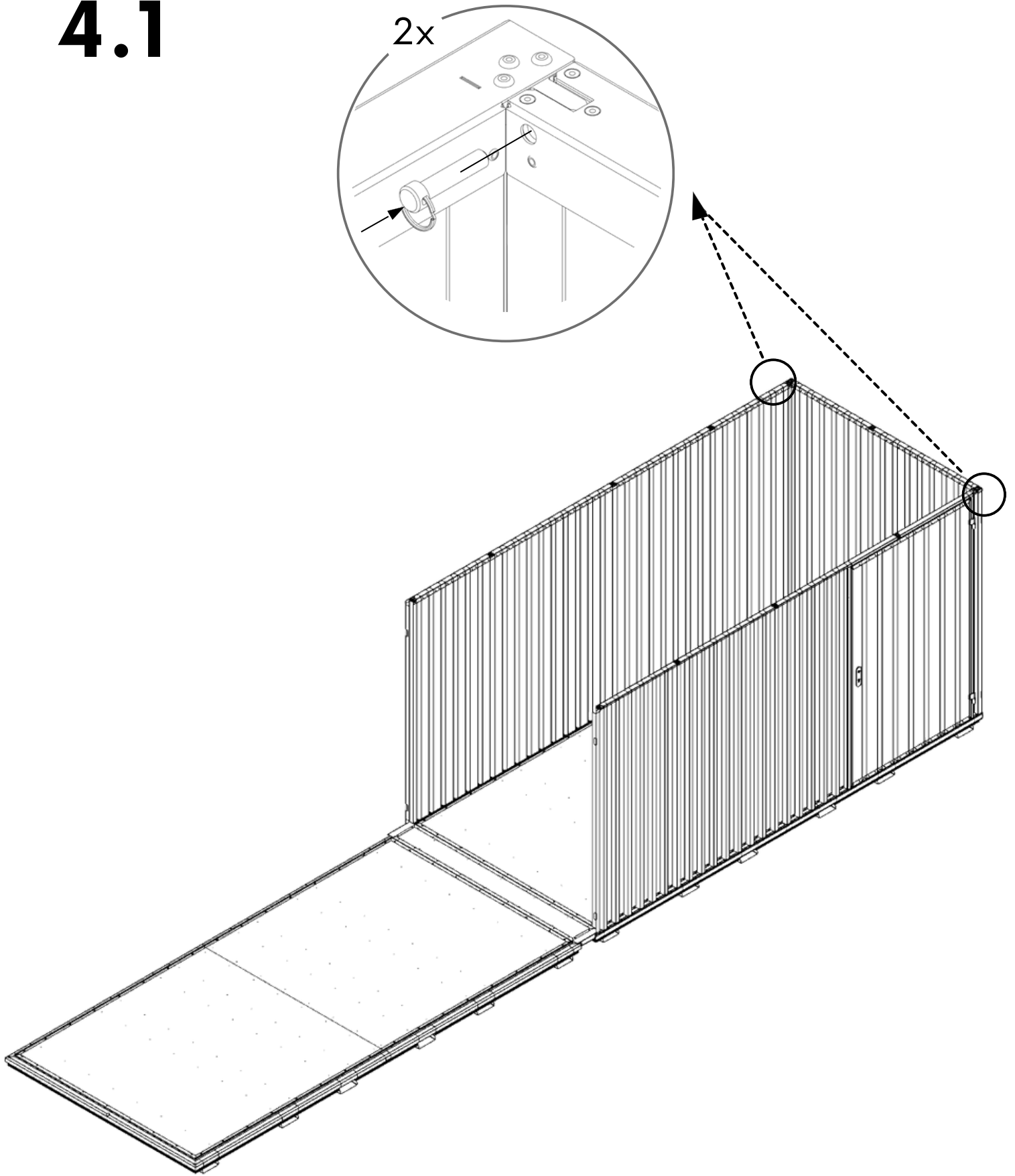

5

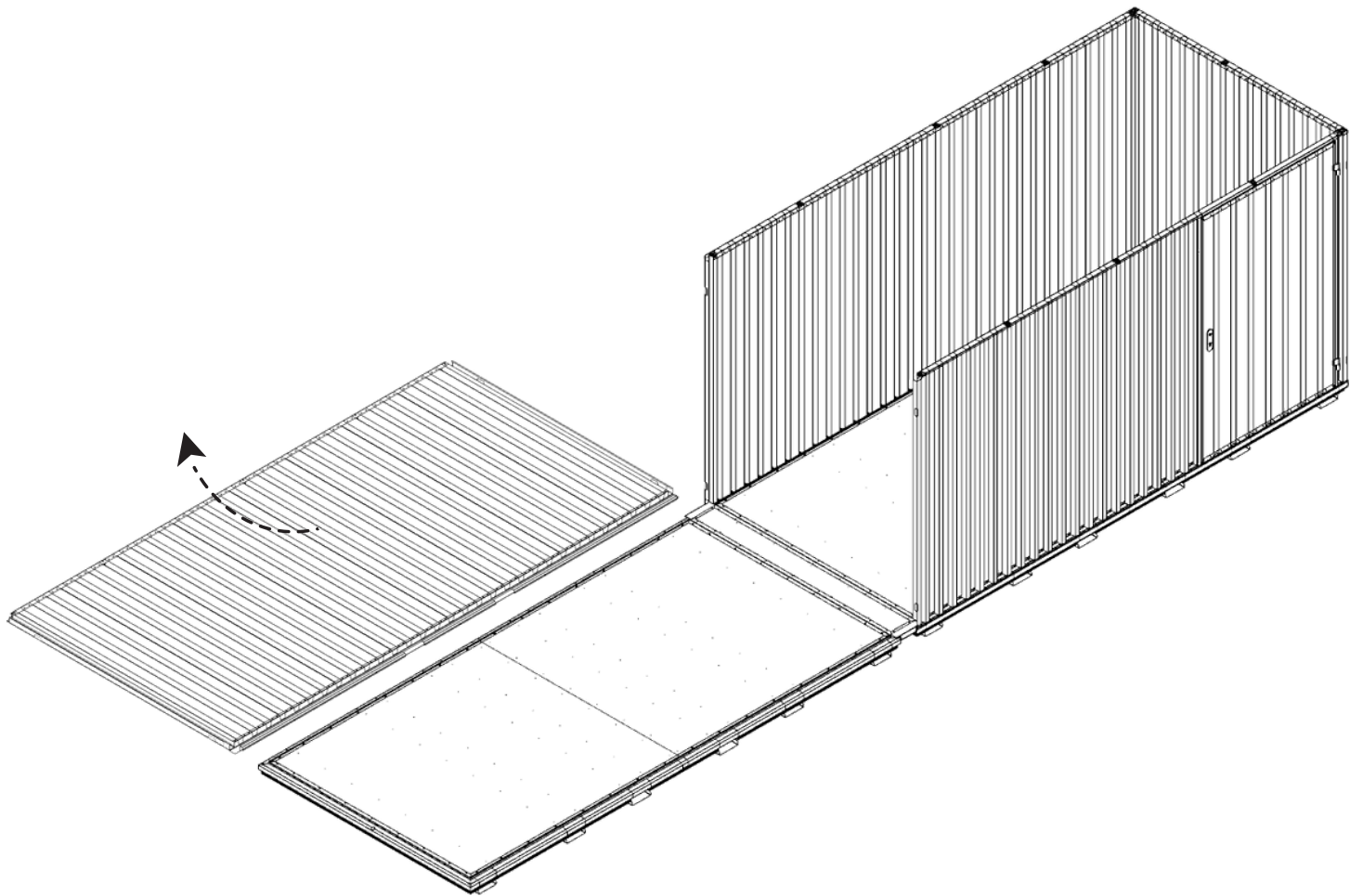

6

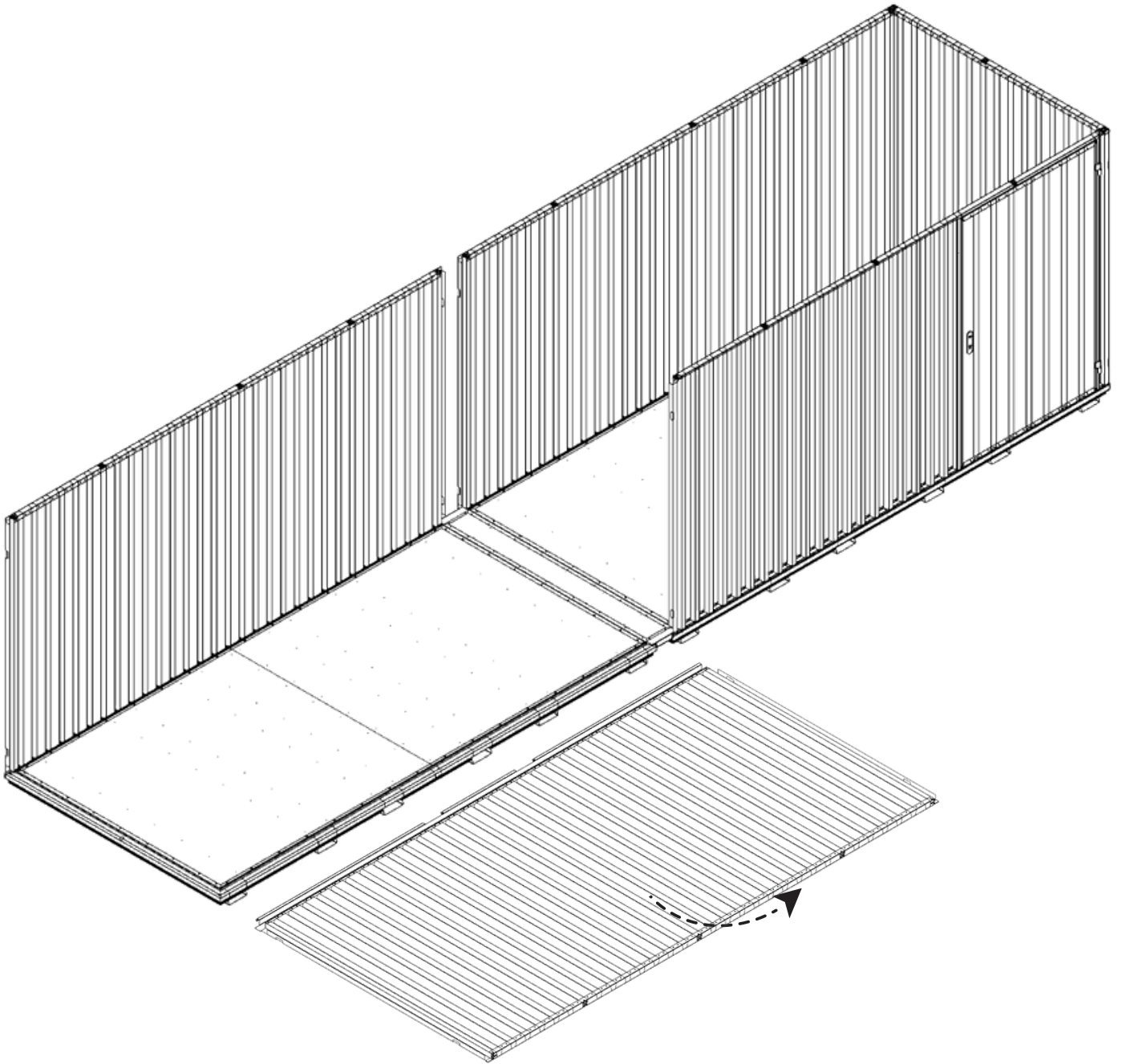

7

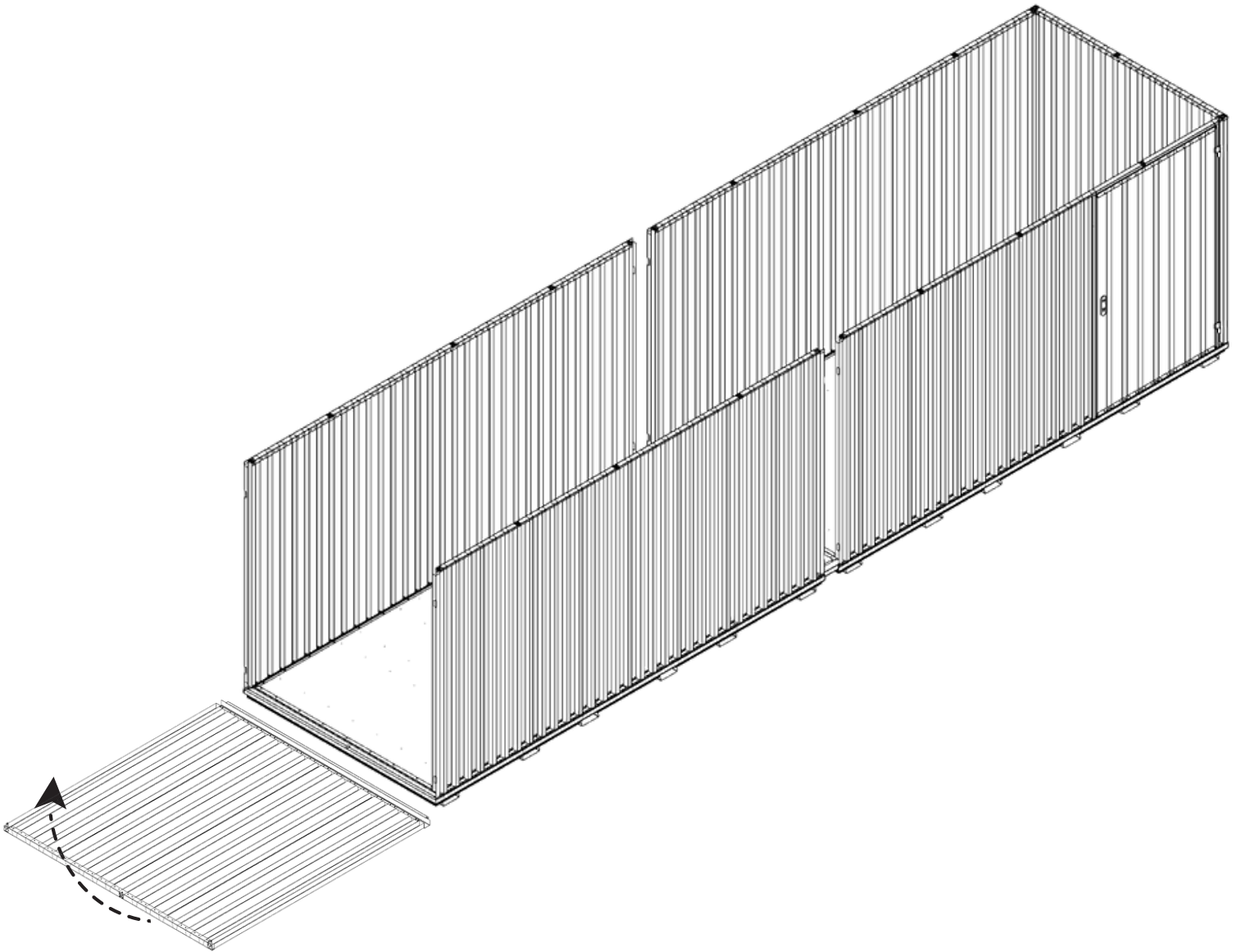

7.1

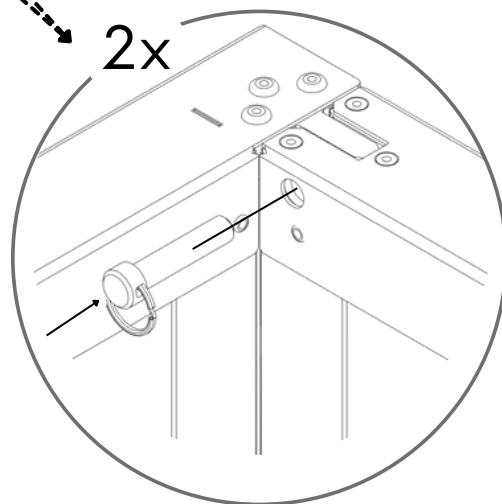
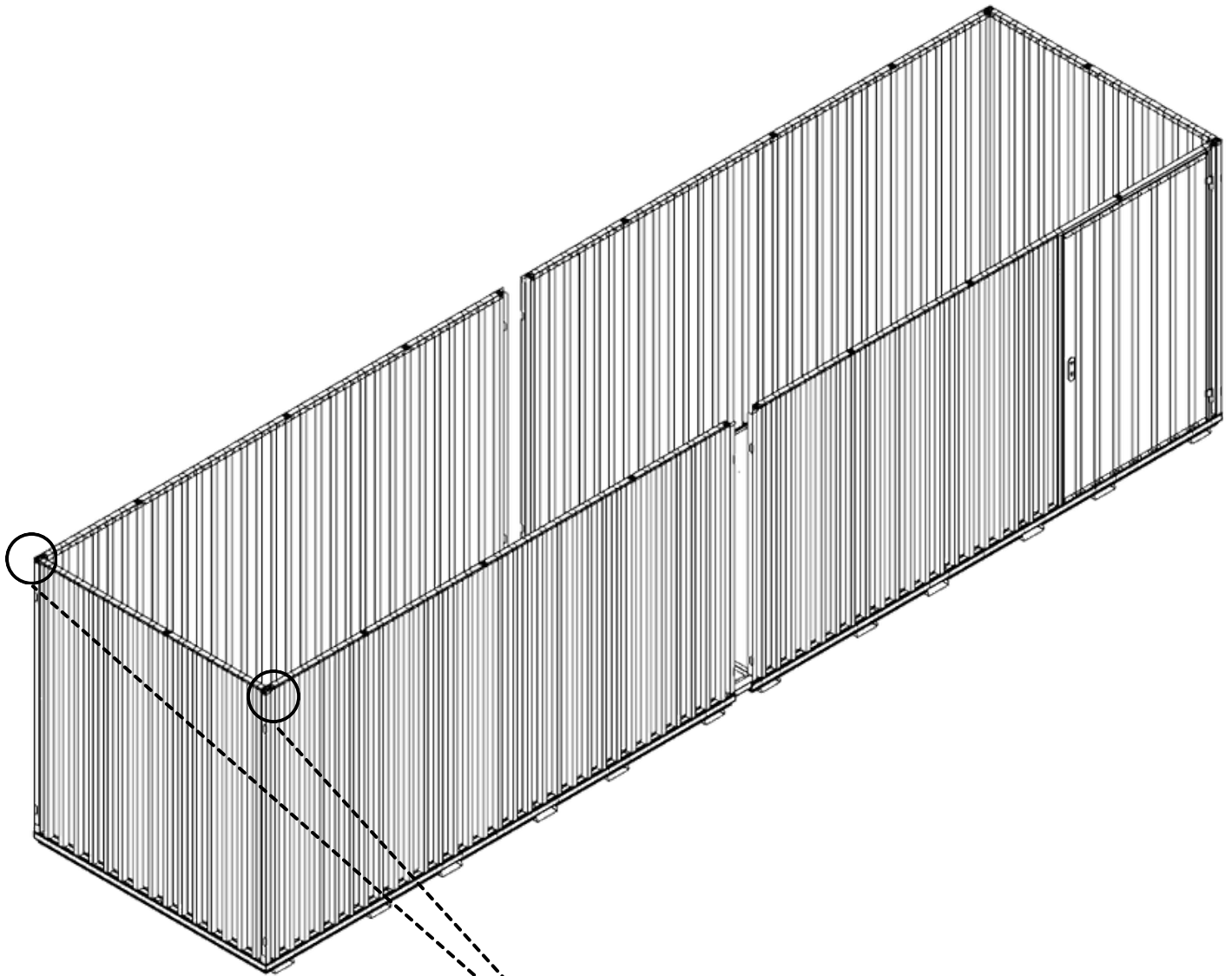

8

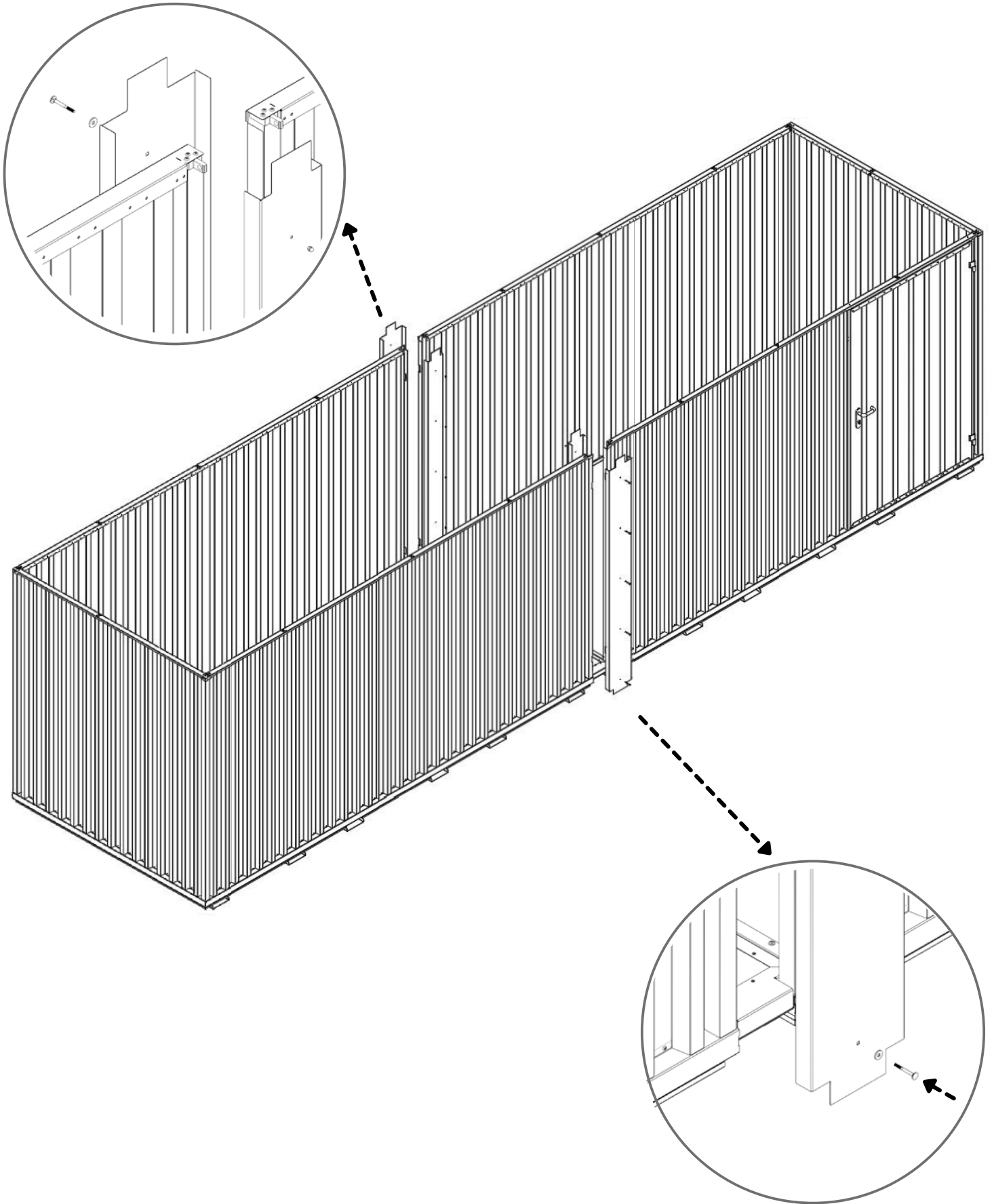

9

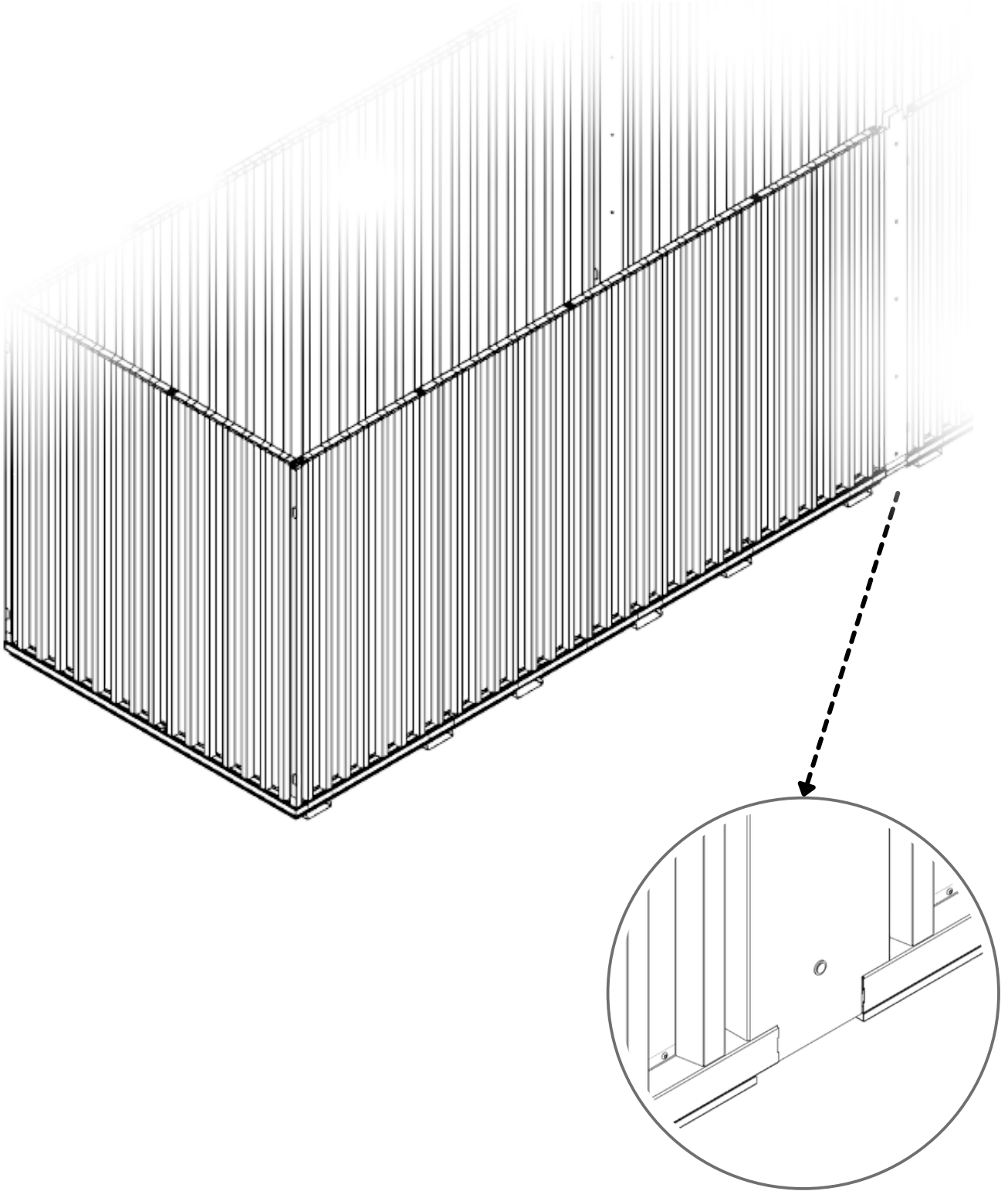



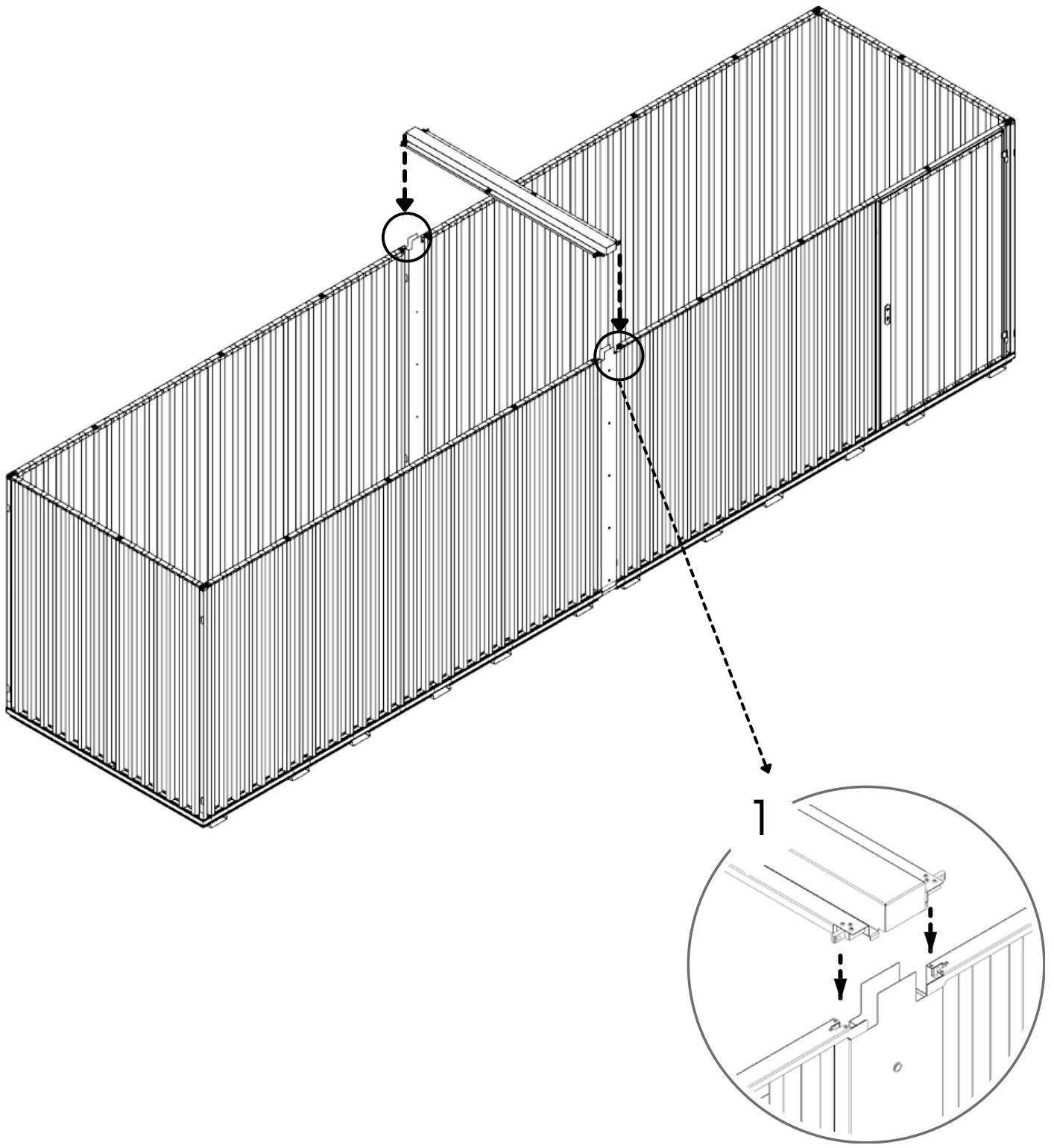



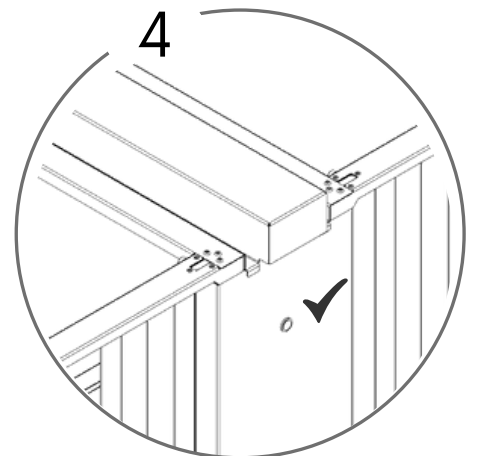
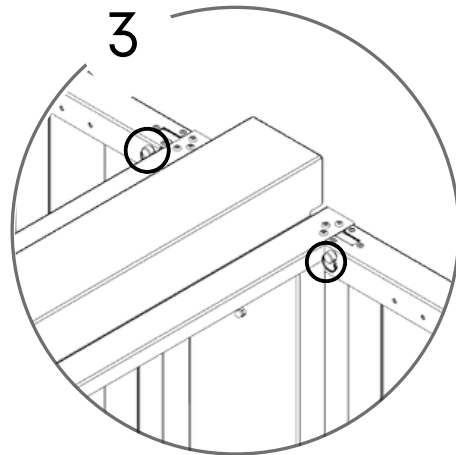
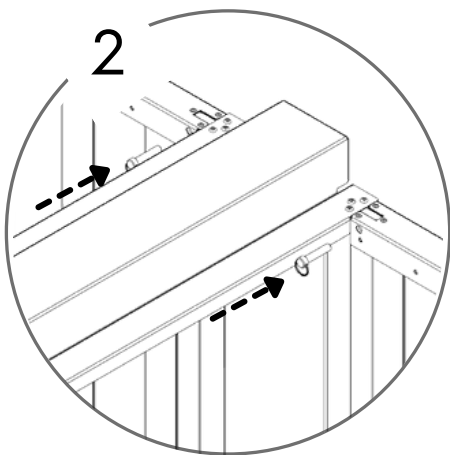
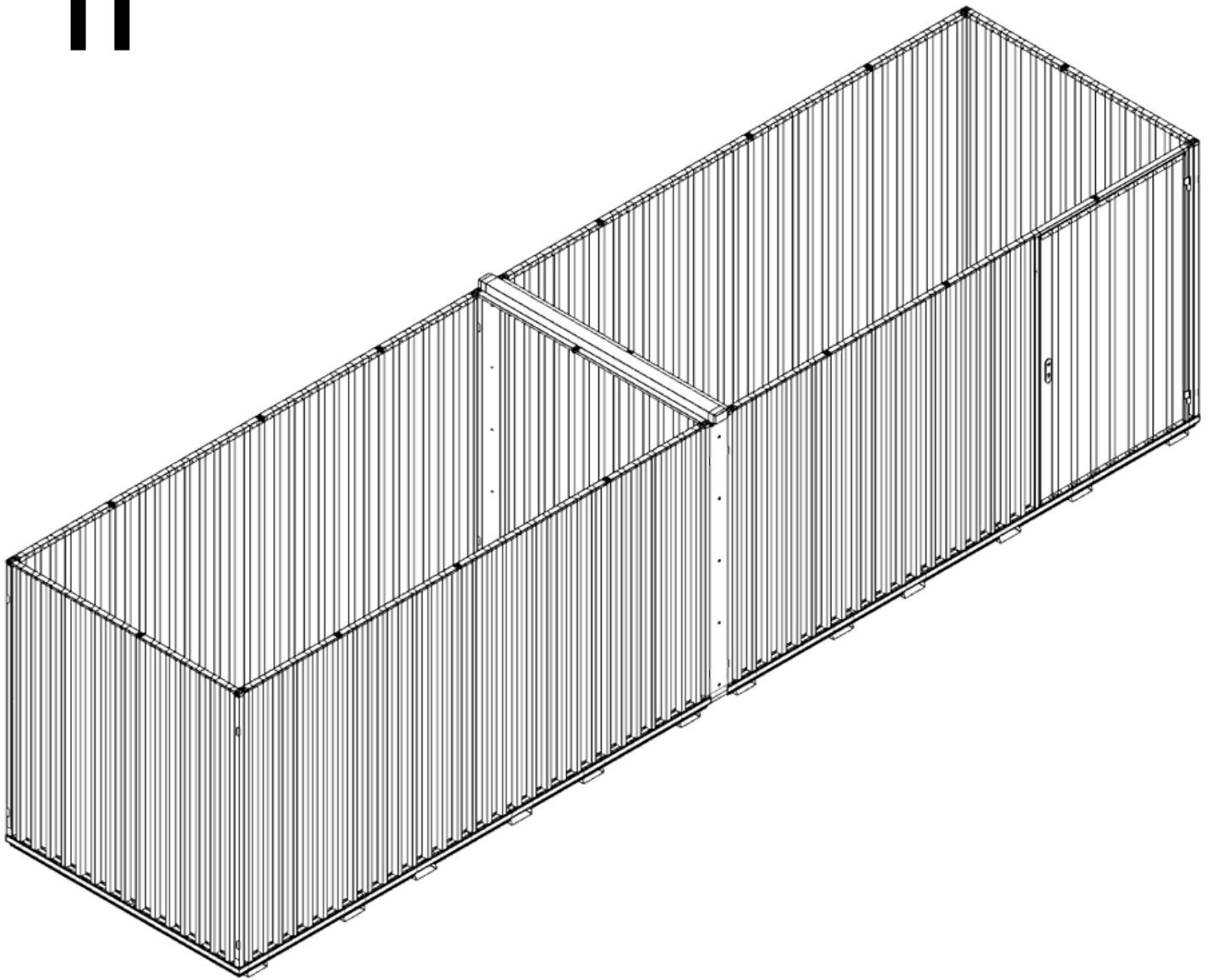

10



11





 799 KG	 1640 MM	Model Code: 4040.110.440 Production Tracking Code:/X09.1.4040.440	 9001	 14001	 50001			
---	--	---	---	--	--	---	---	---

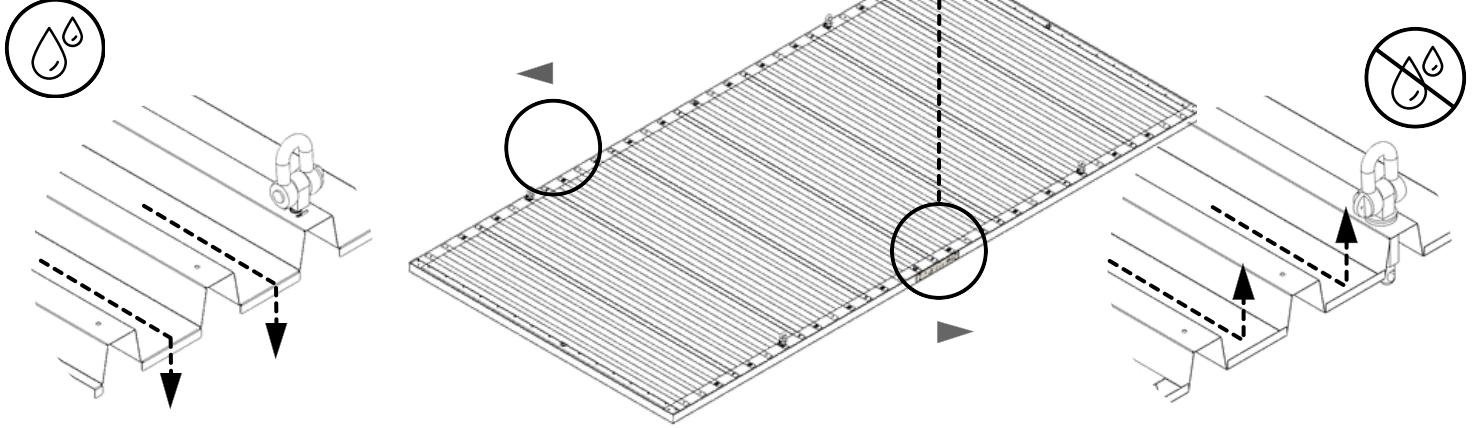

12

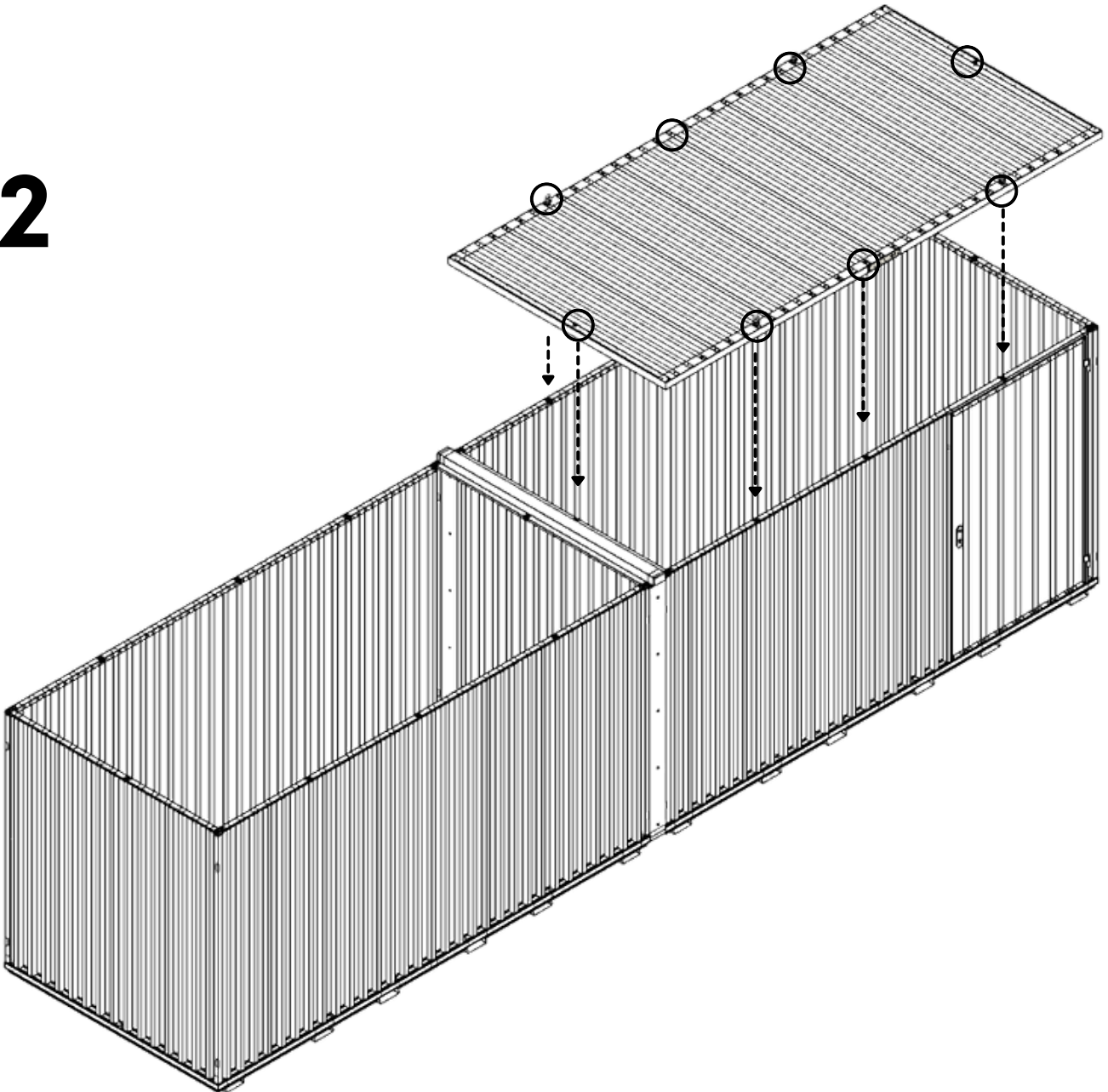

13

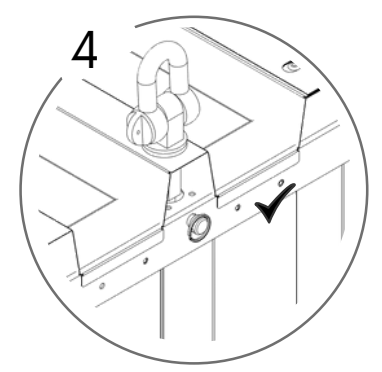
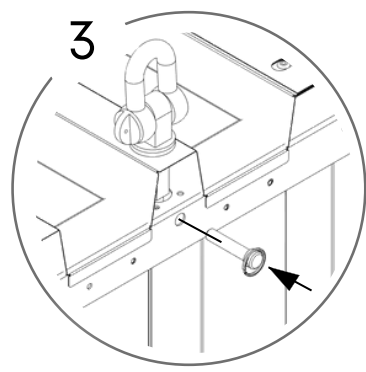
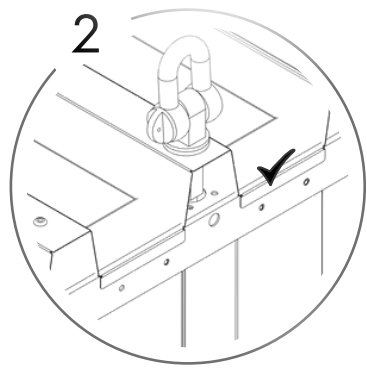
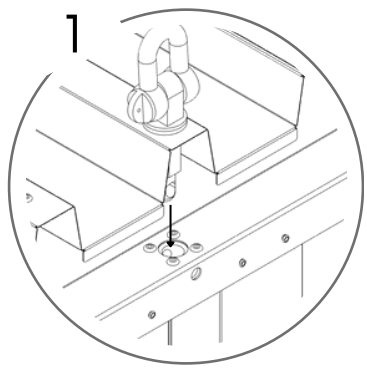
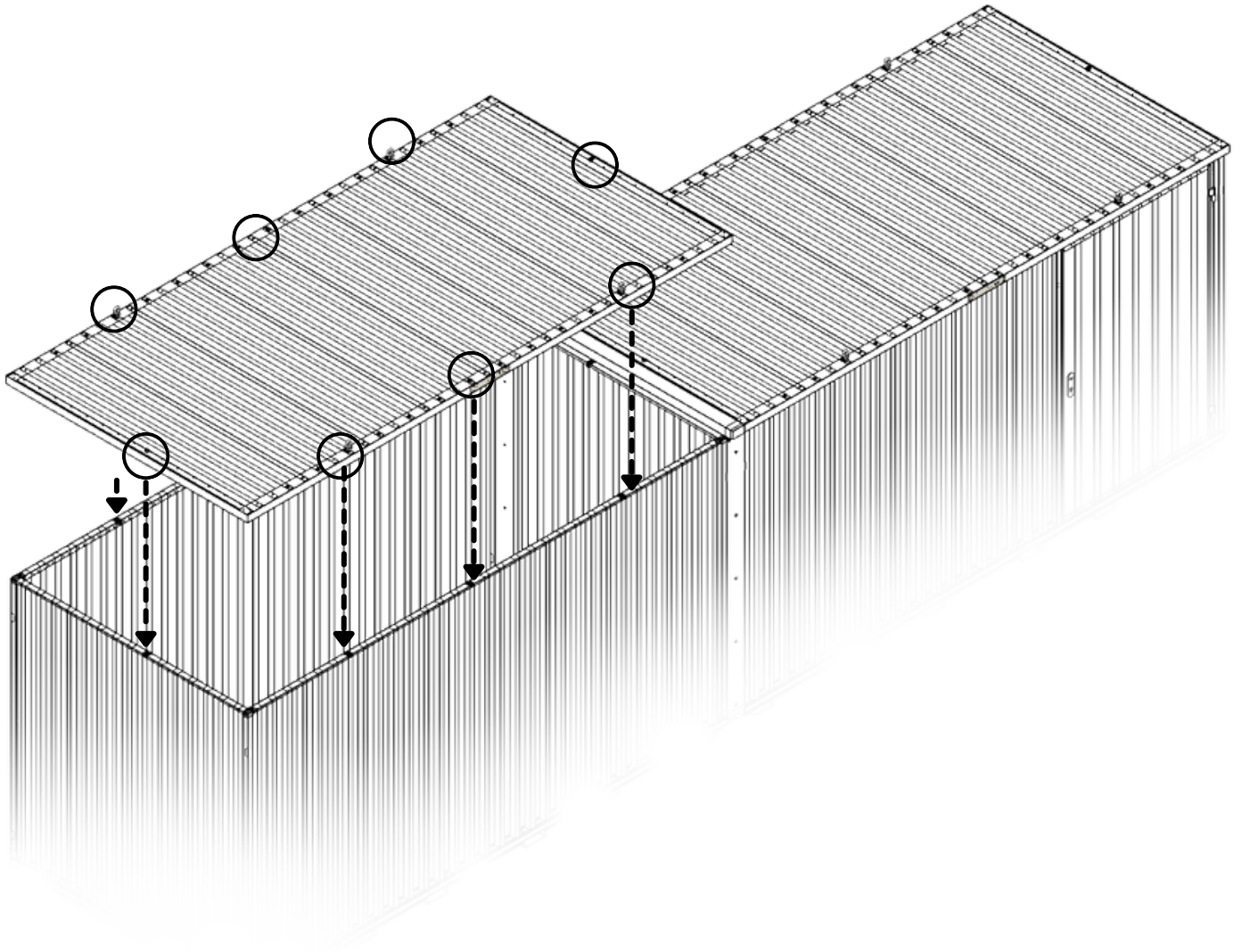

14

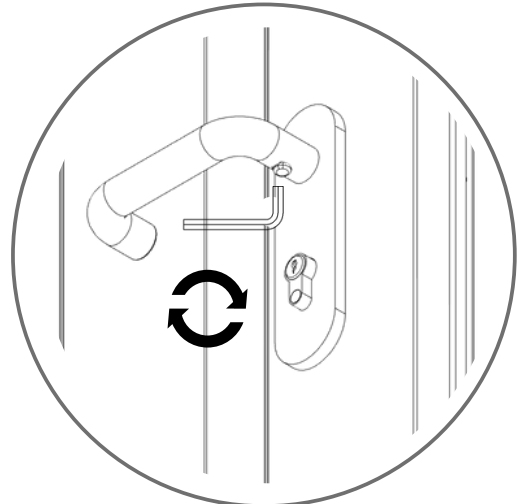
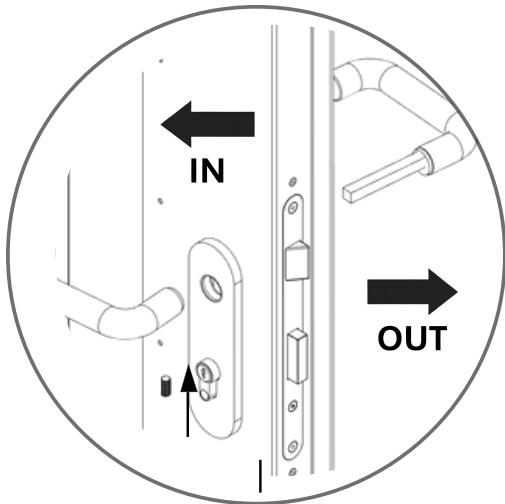
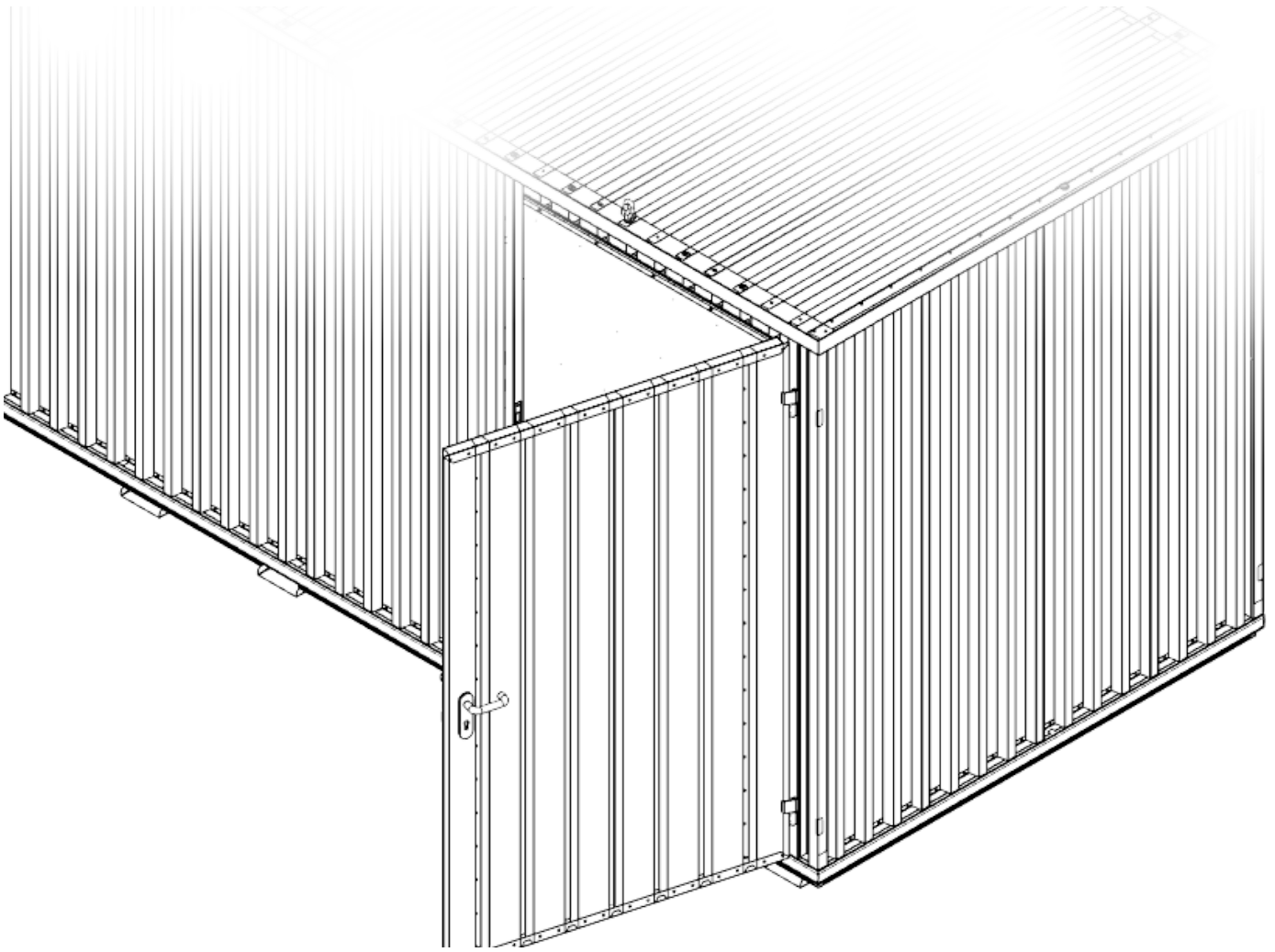

15

