

PRODUCT CODE:3033.110.420.440

prefabase
Quick Build Solutions

Instructions and User Guide

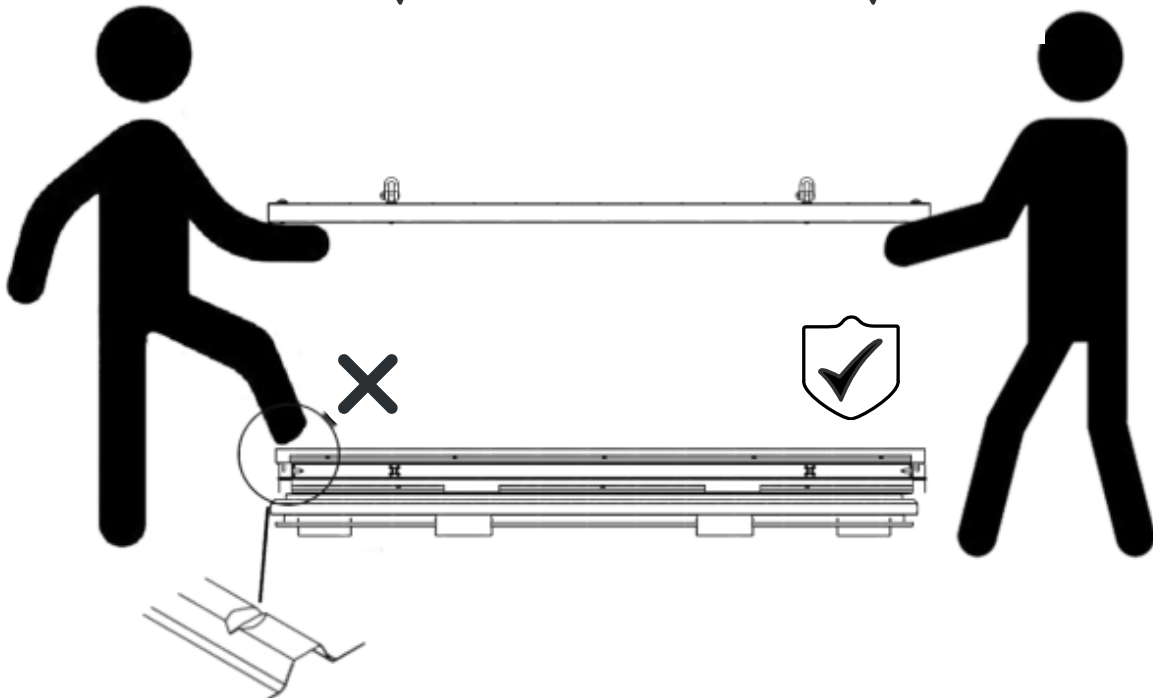
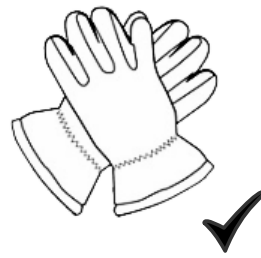

30.0110

3x

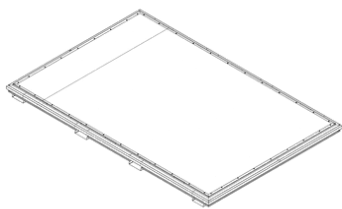

30.0510

3x

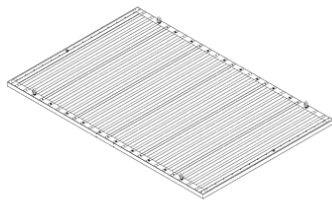

303.0110

2x



303.0510

2x



30.0420

1x

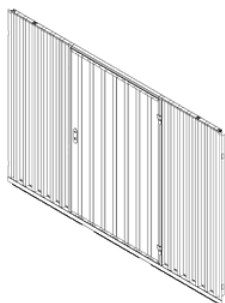

30.0440

1x

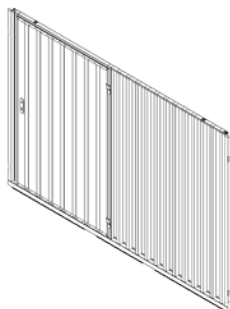

0310

6x

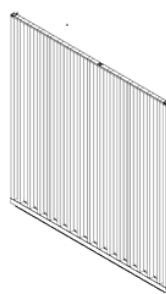

305.20.08

4x



305.20.09

4x



61.101

4x



30x

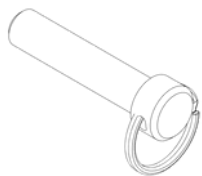

2x

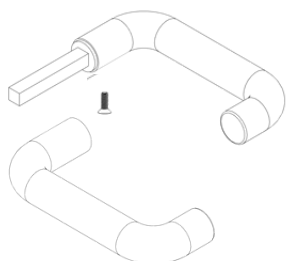

20x



20x



20x



1x



2x



1

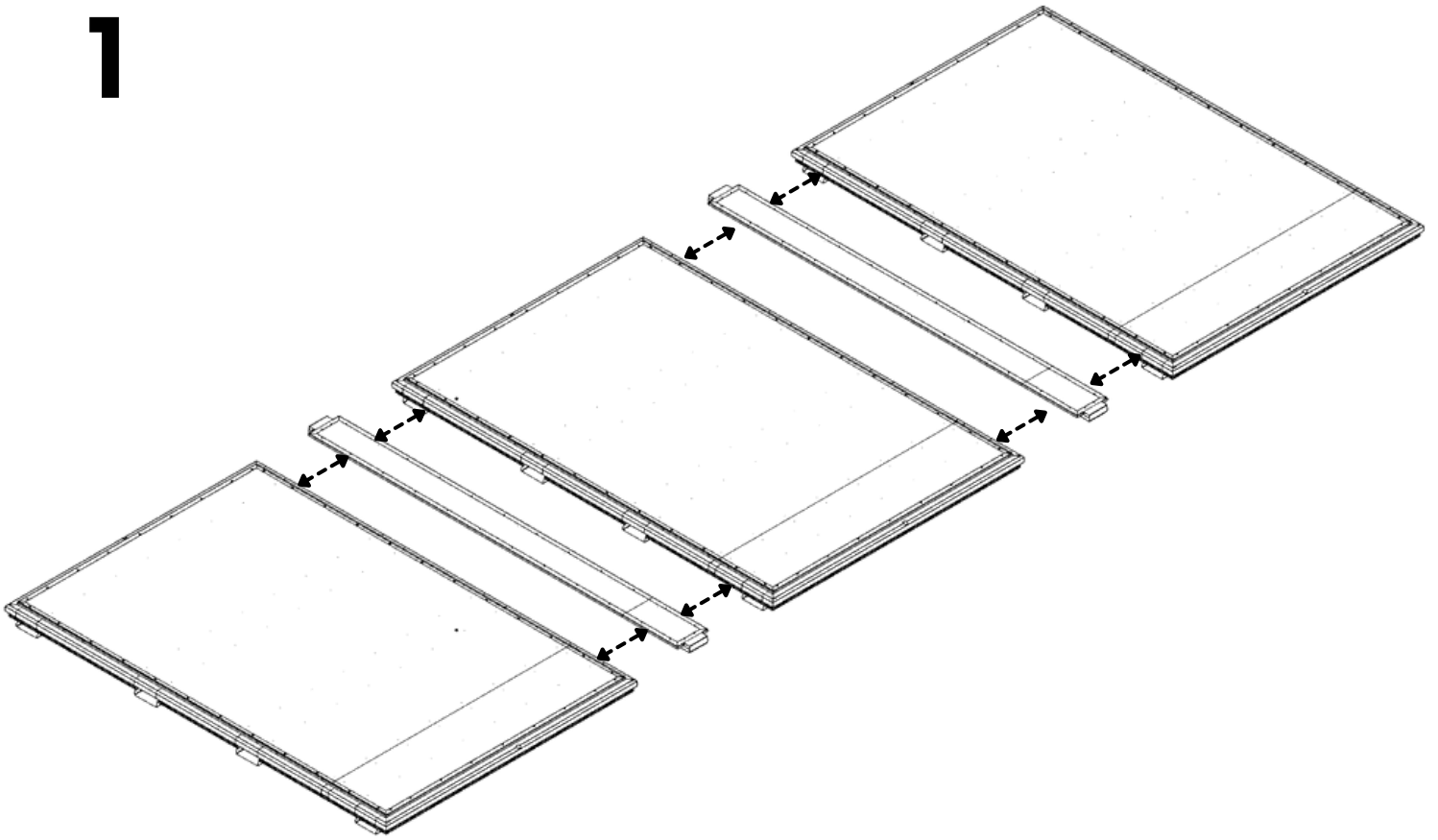

2

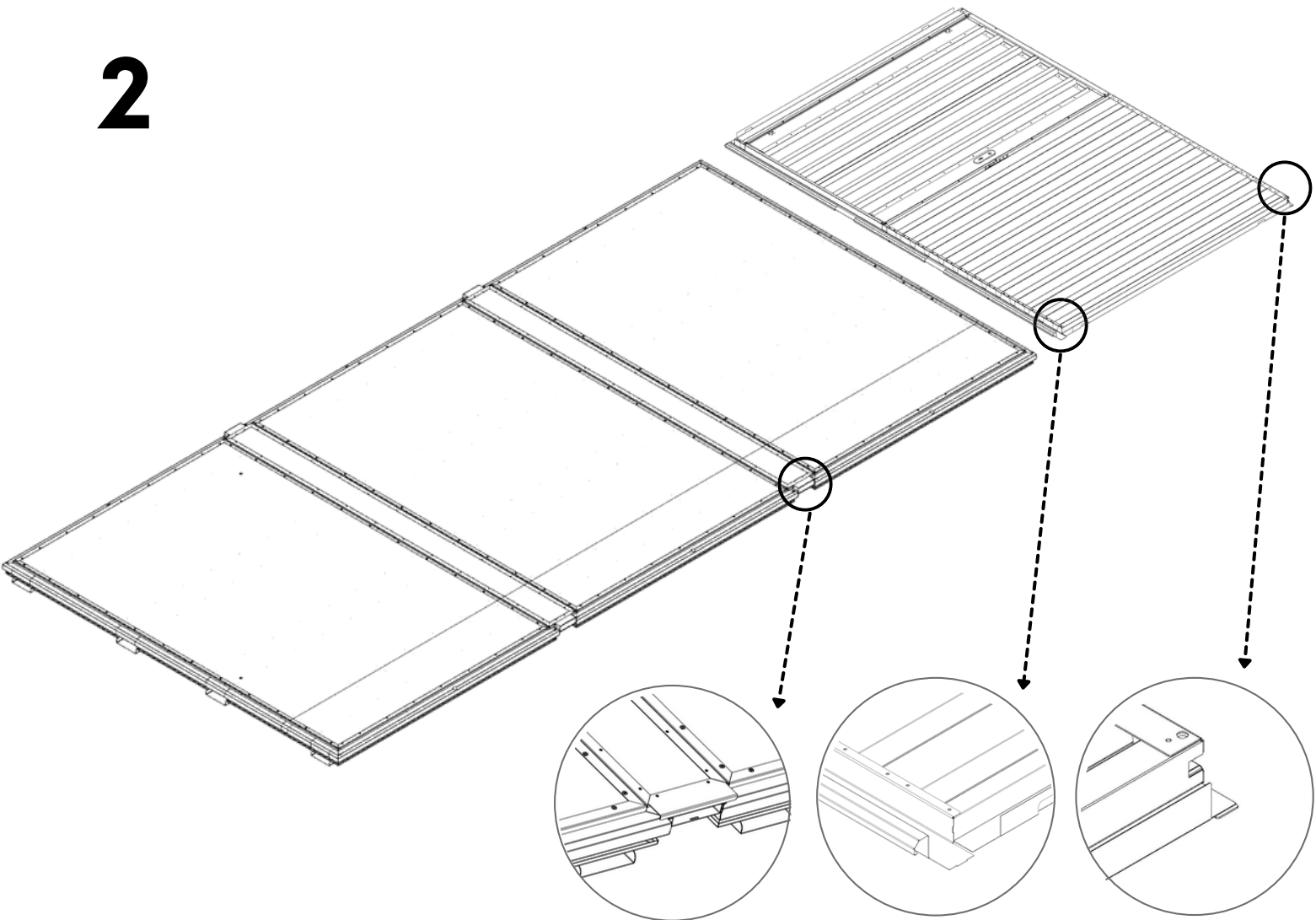

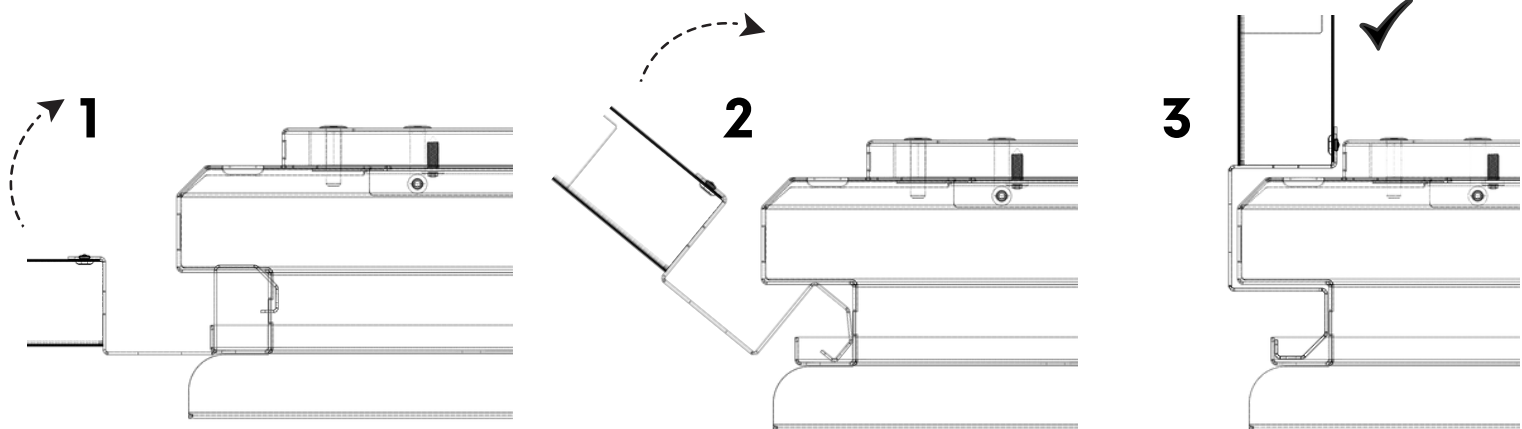

3

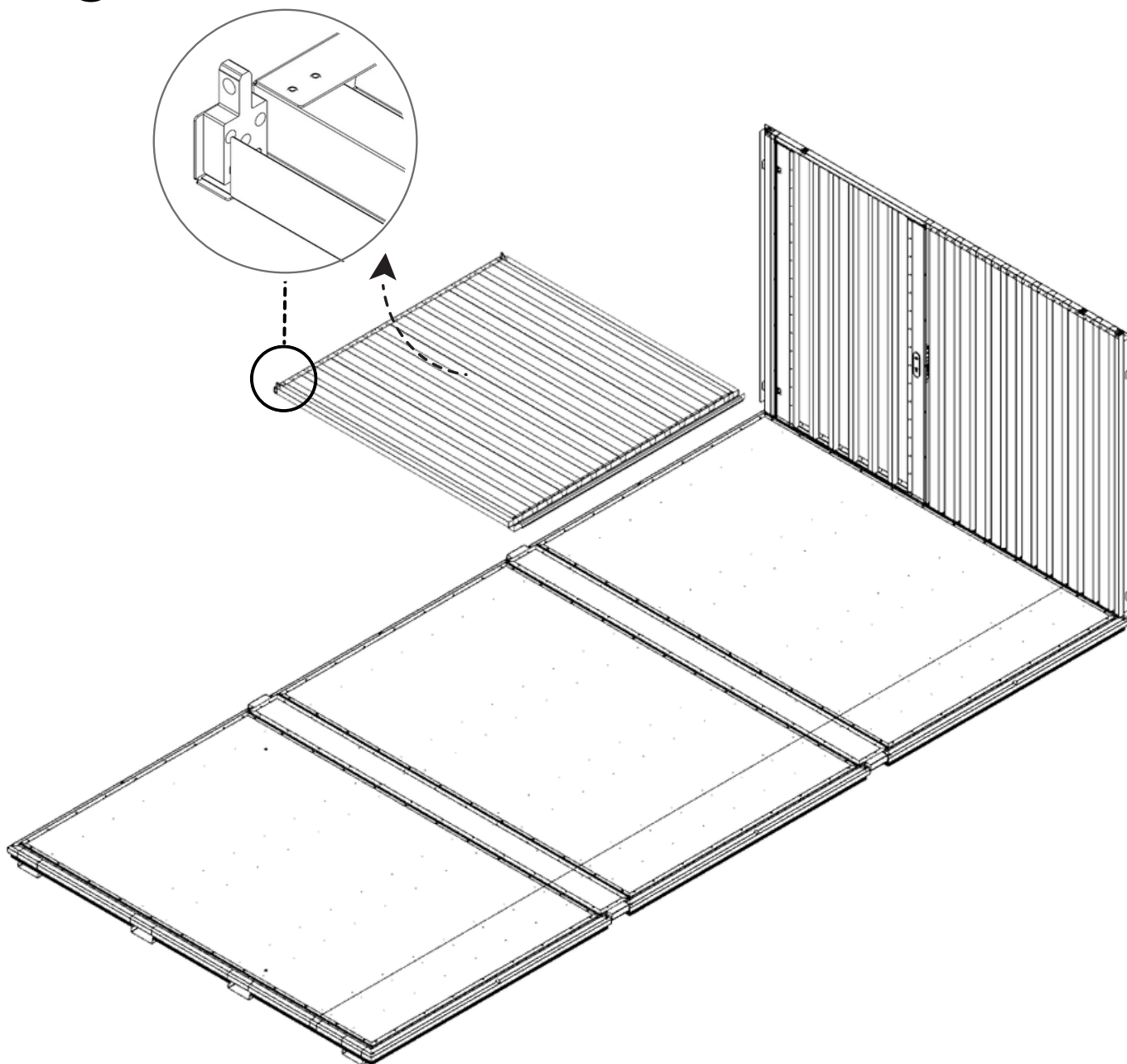

4

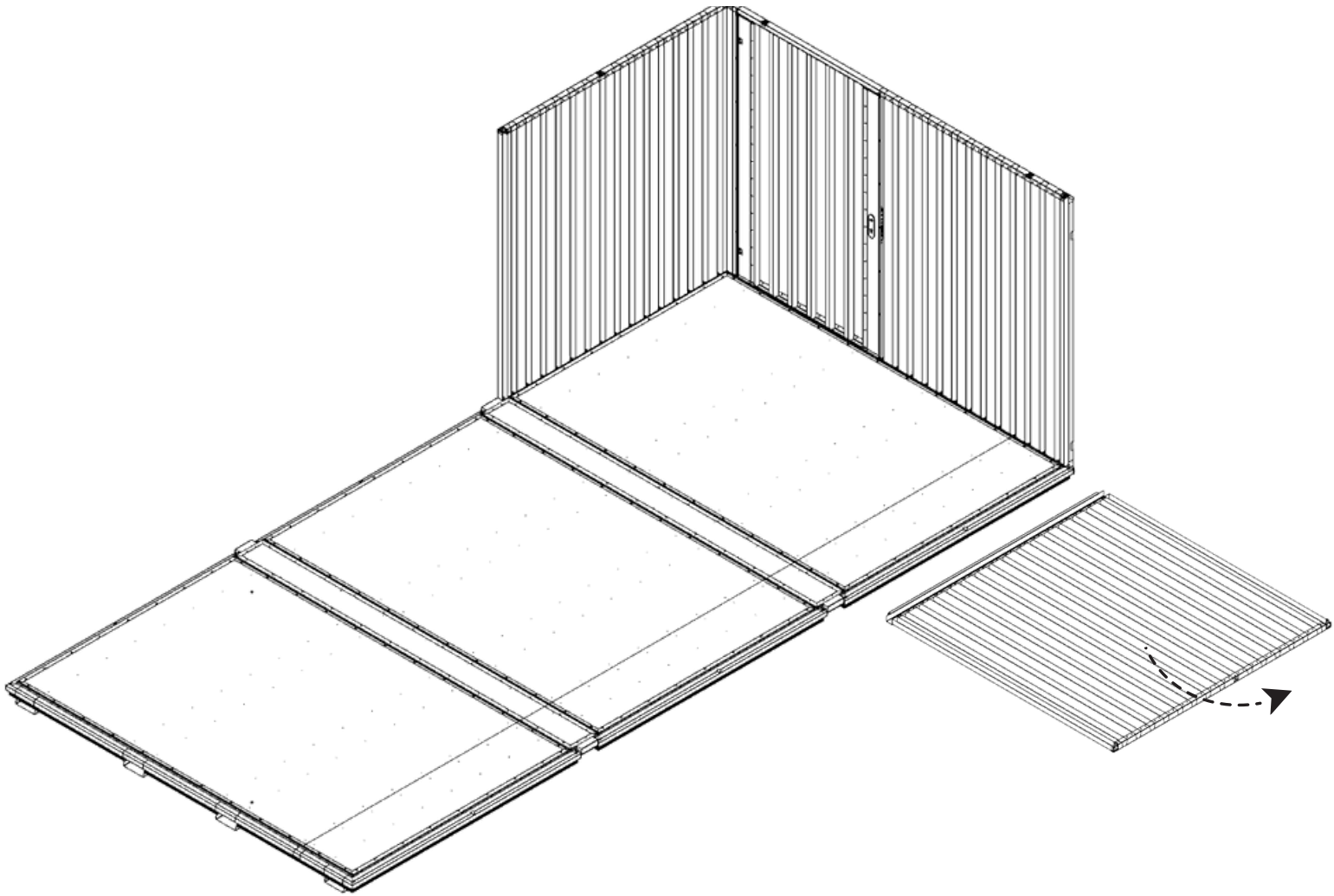

4.1

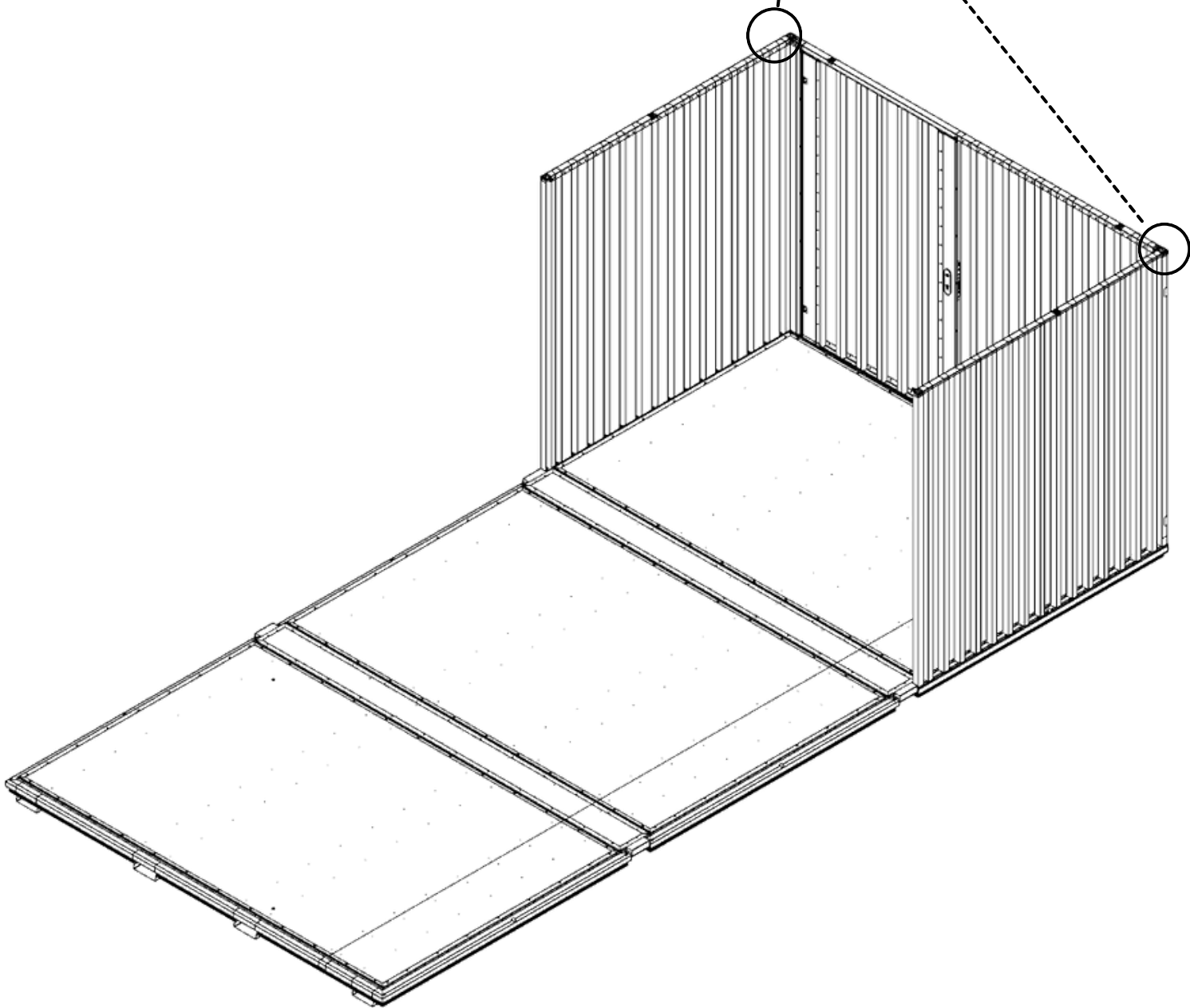
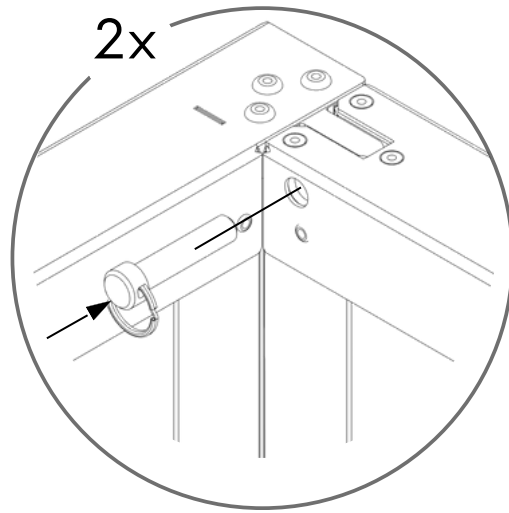

5

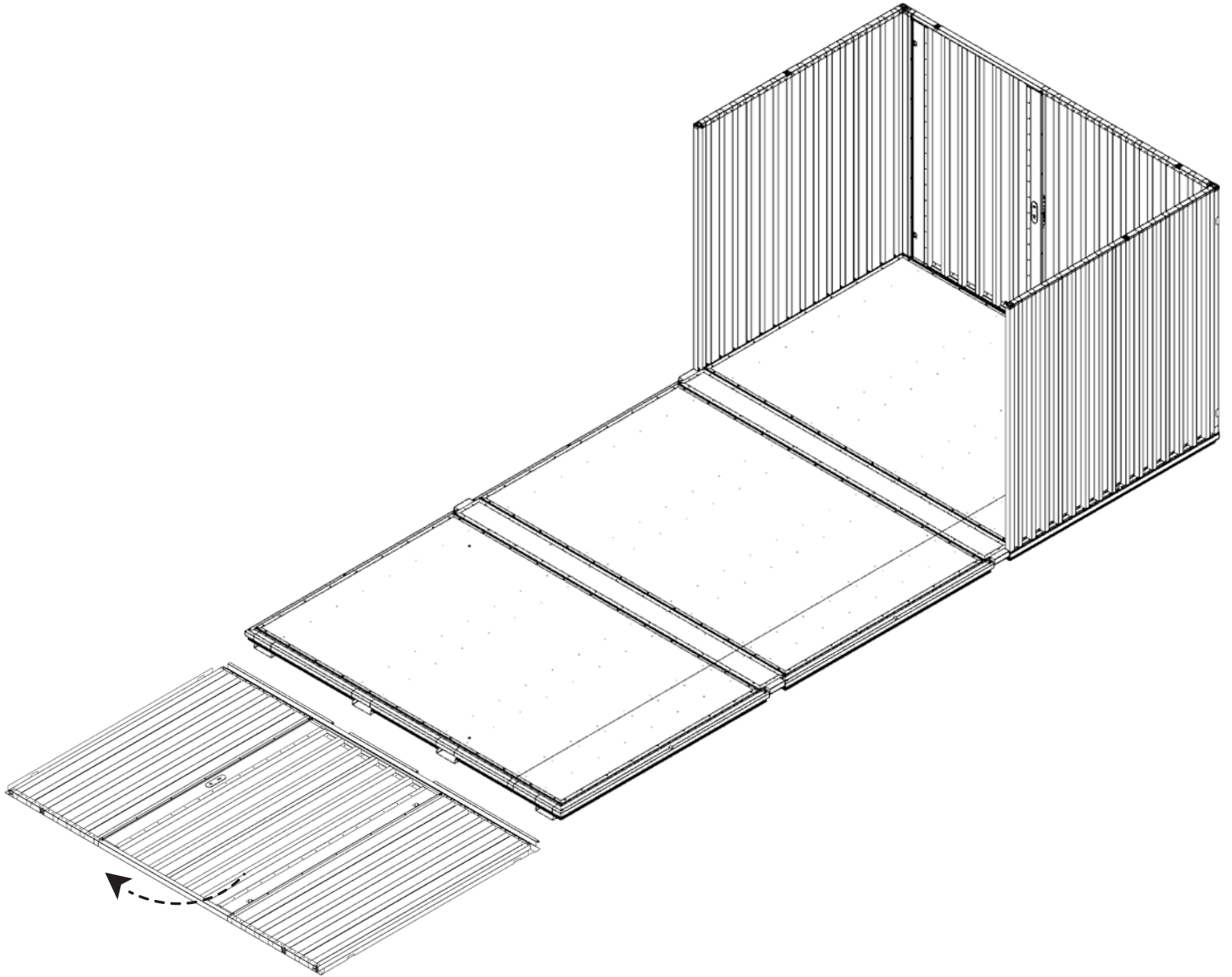

6

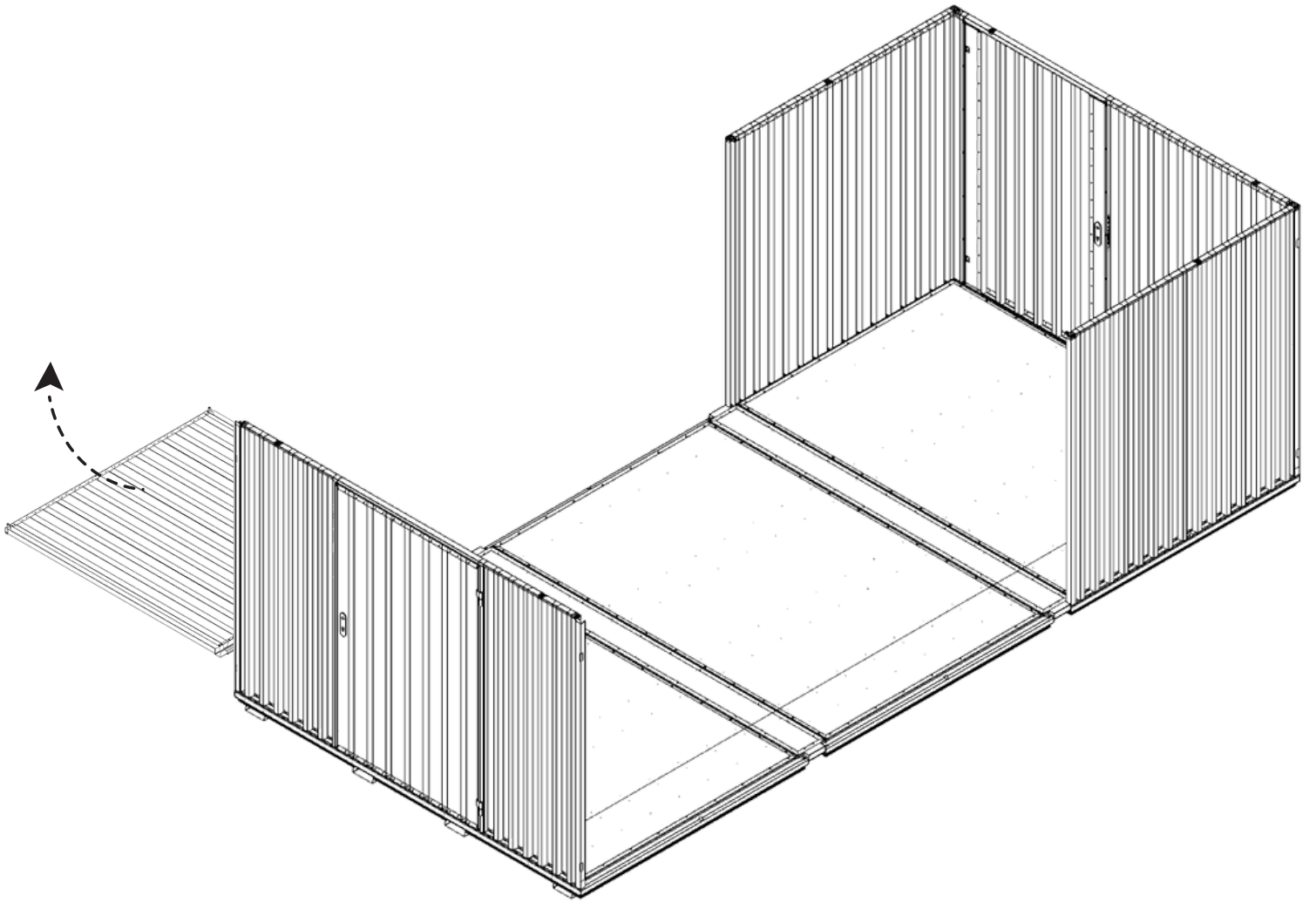

7

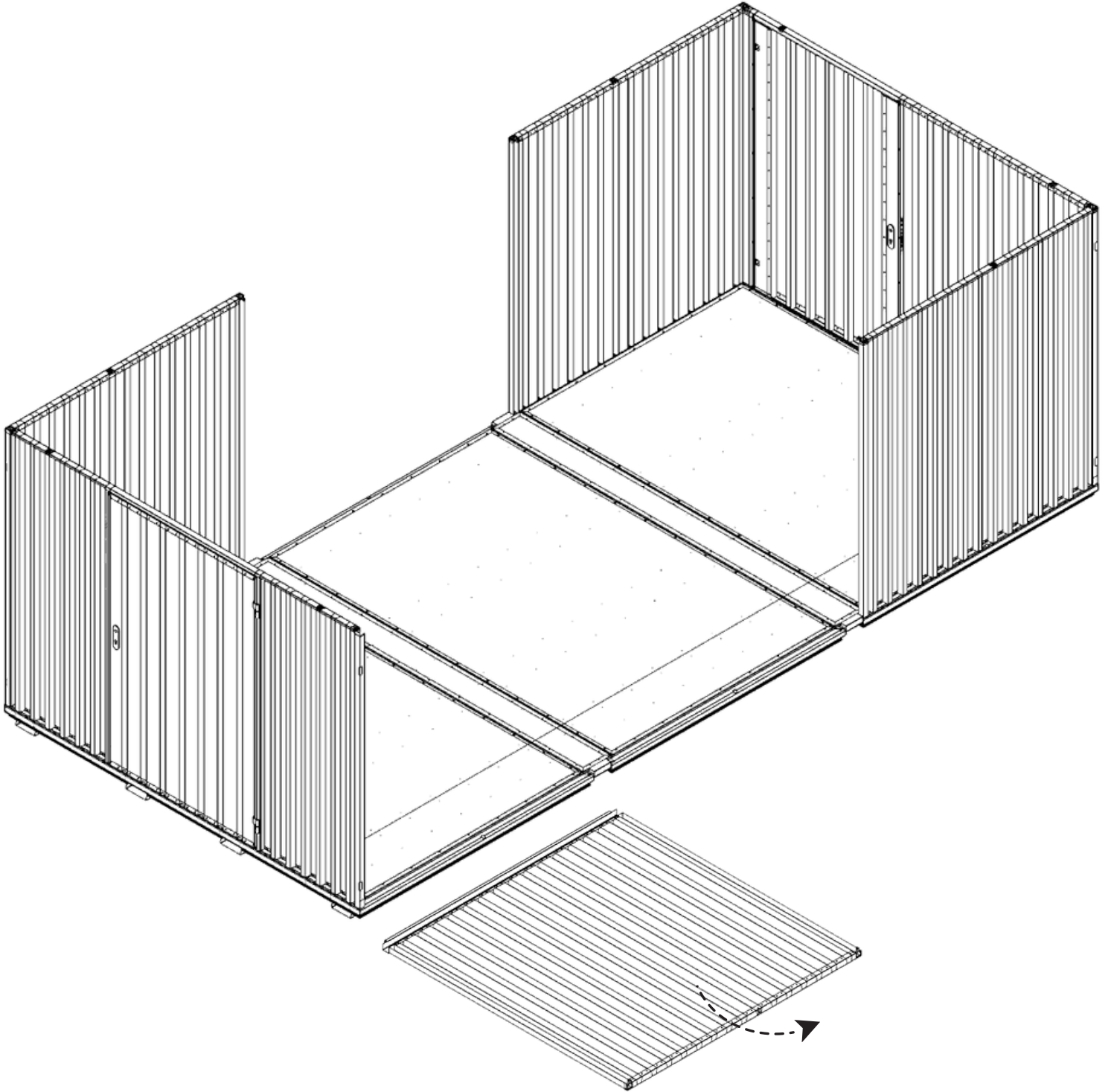

7.1

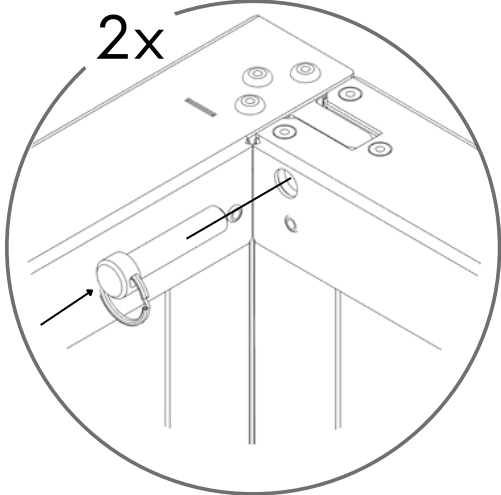
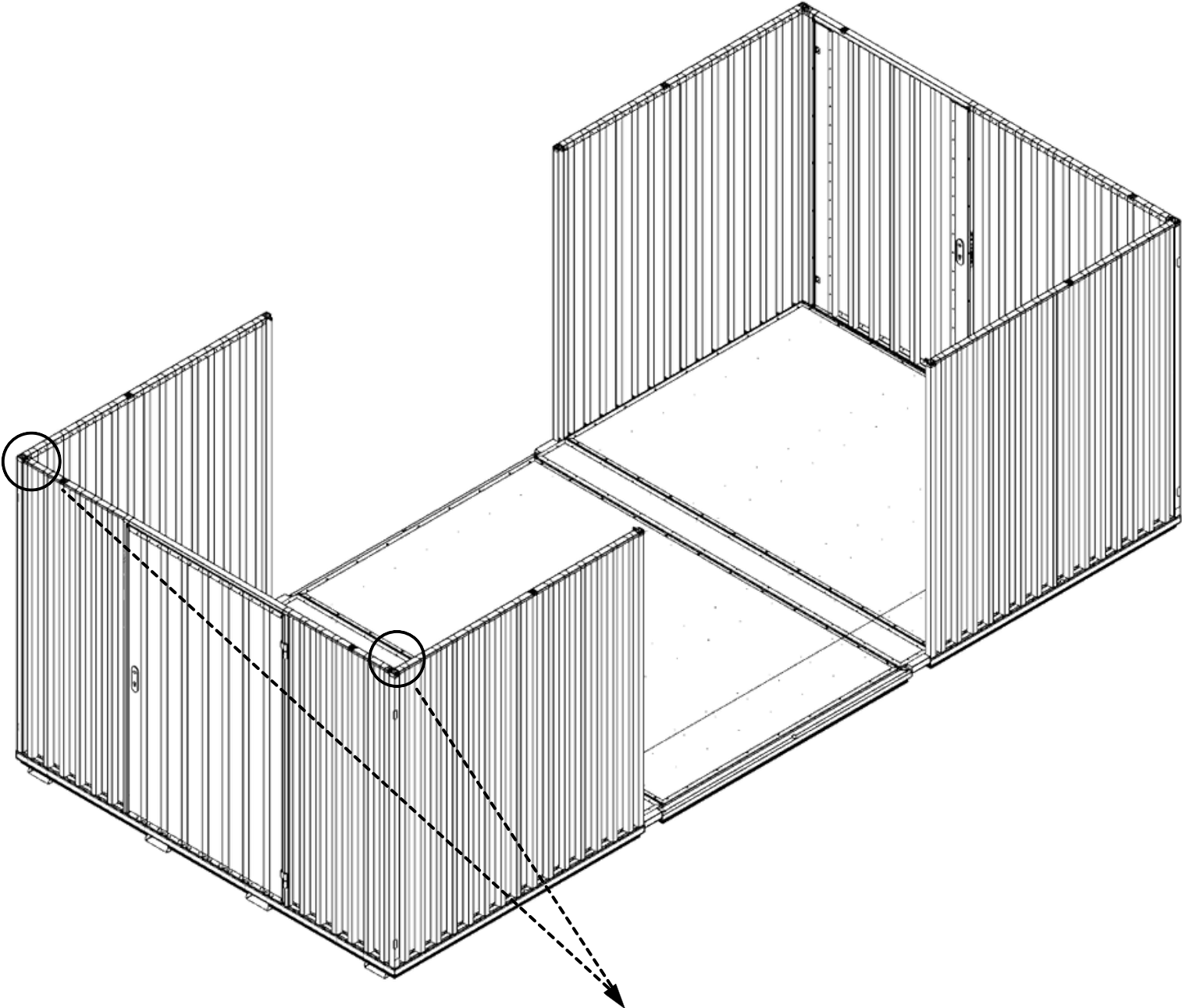

8

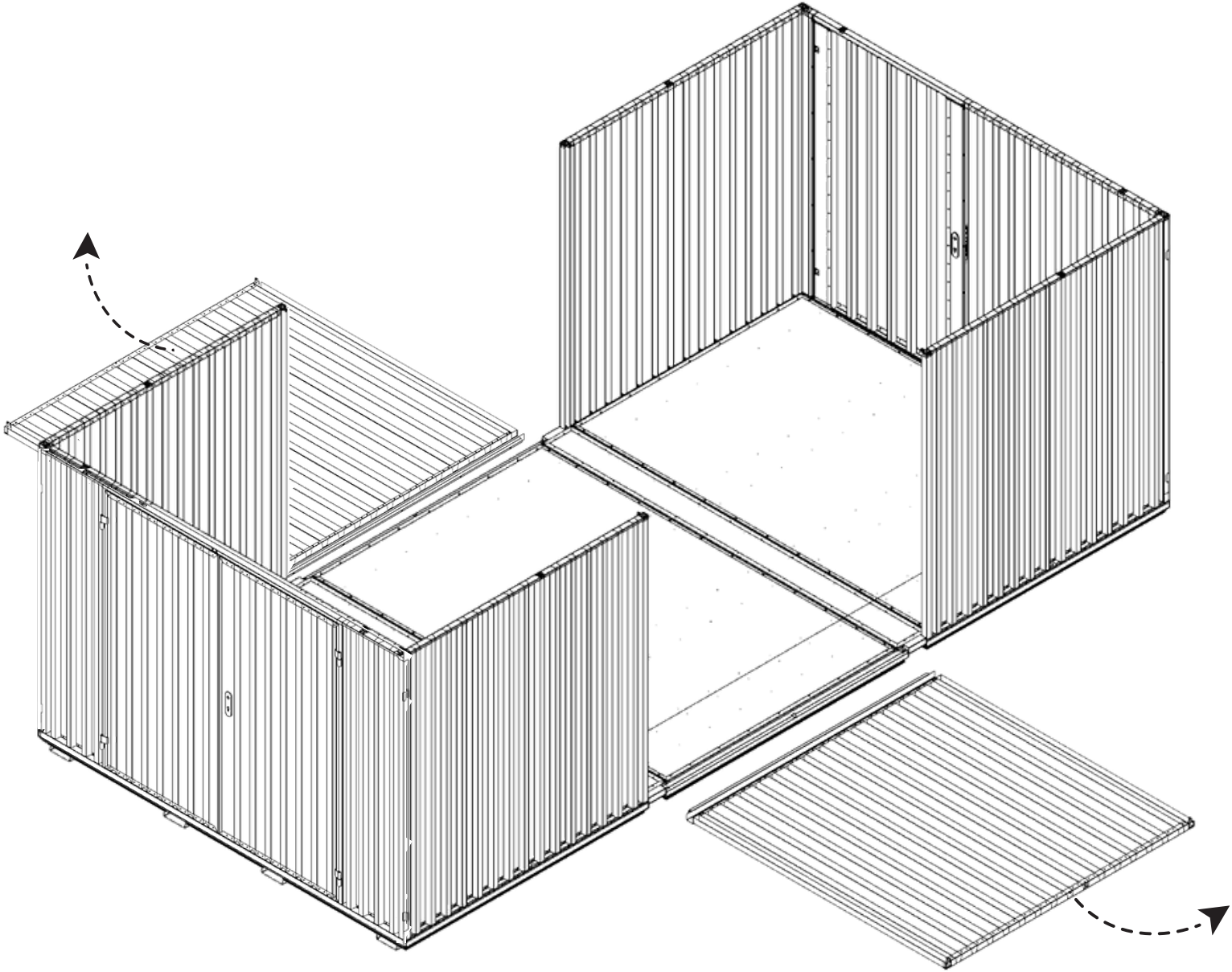

9

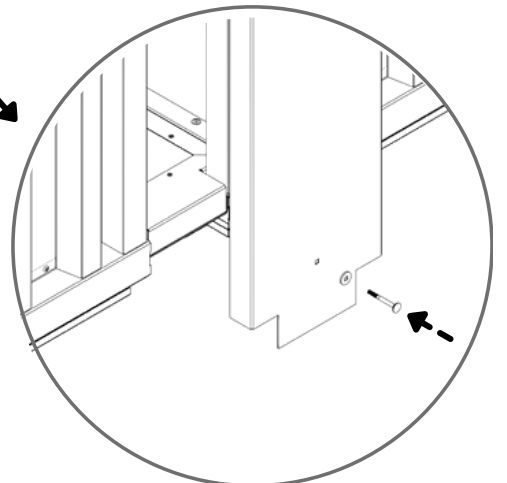
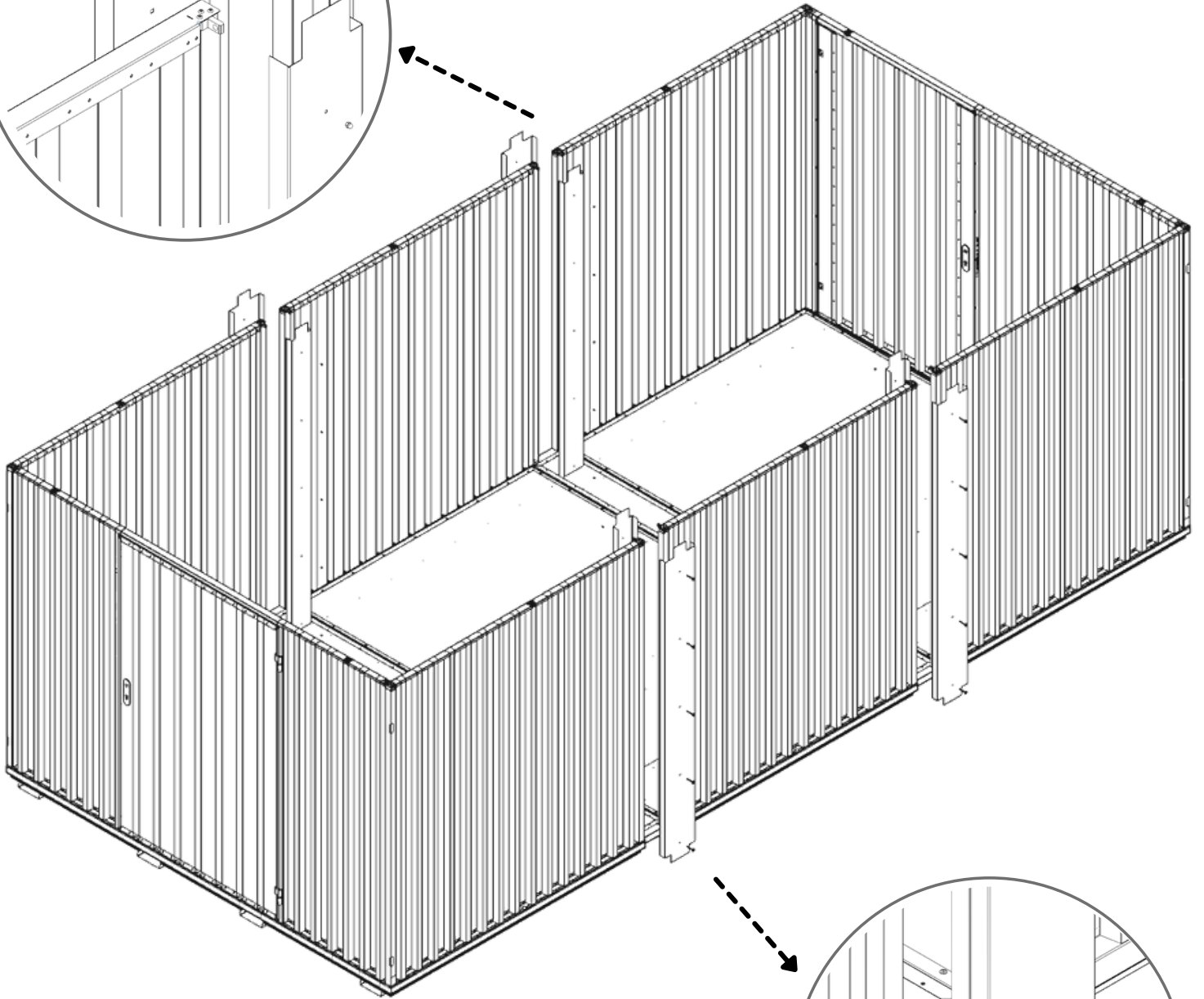
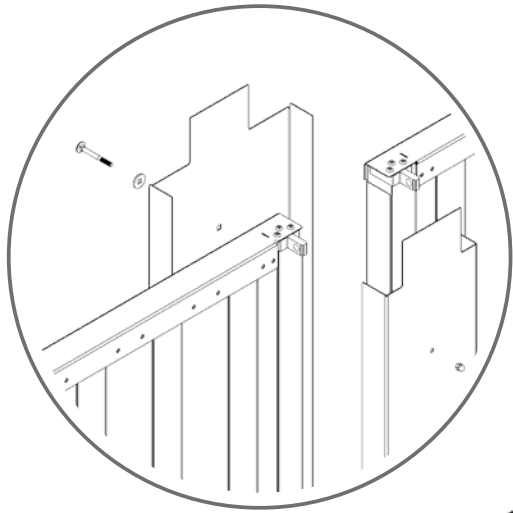

9.1

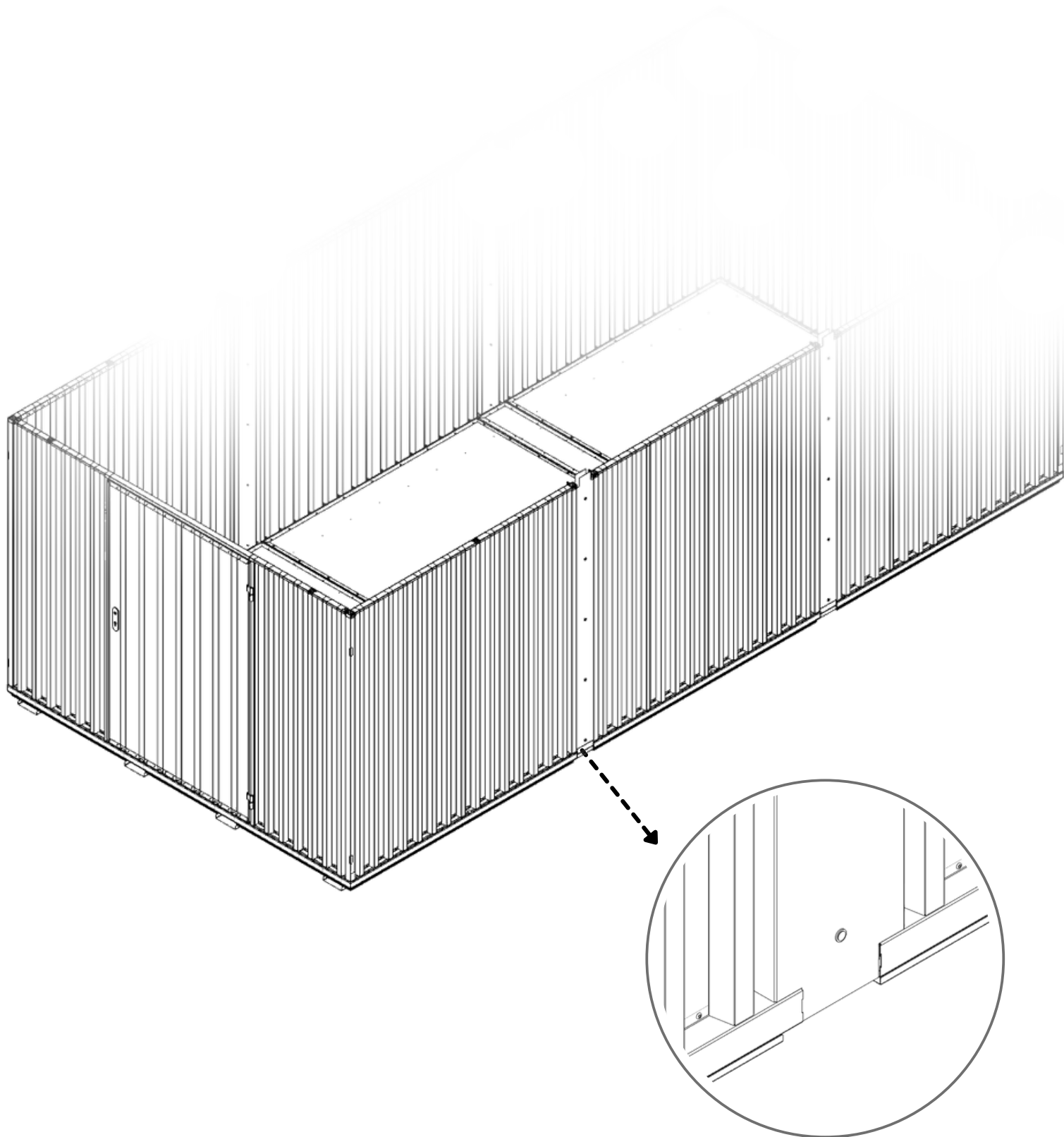



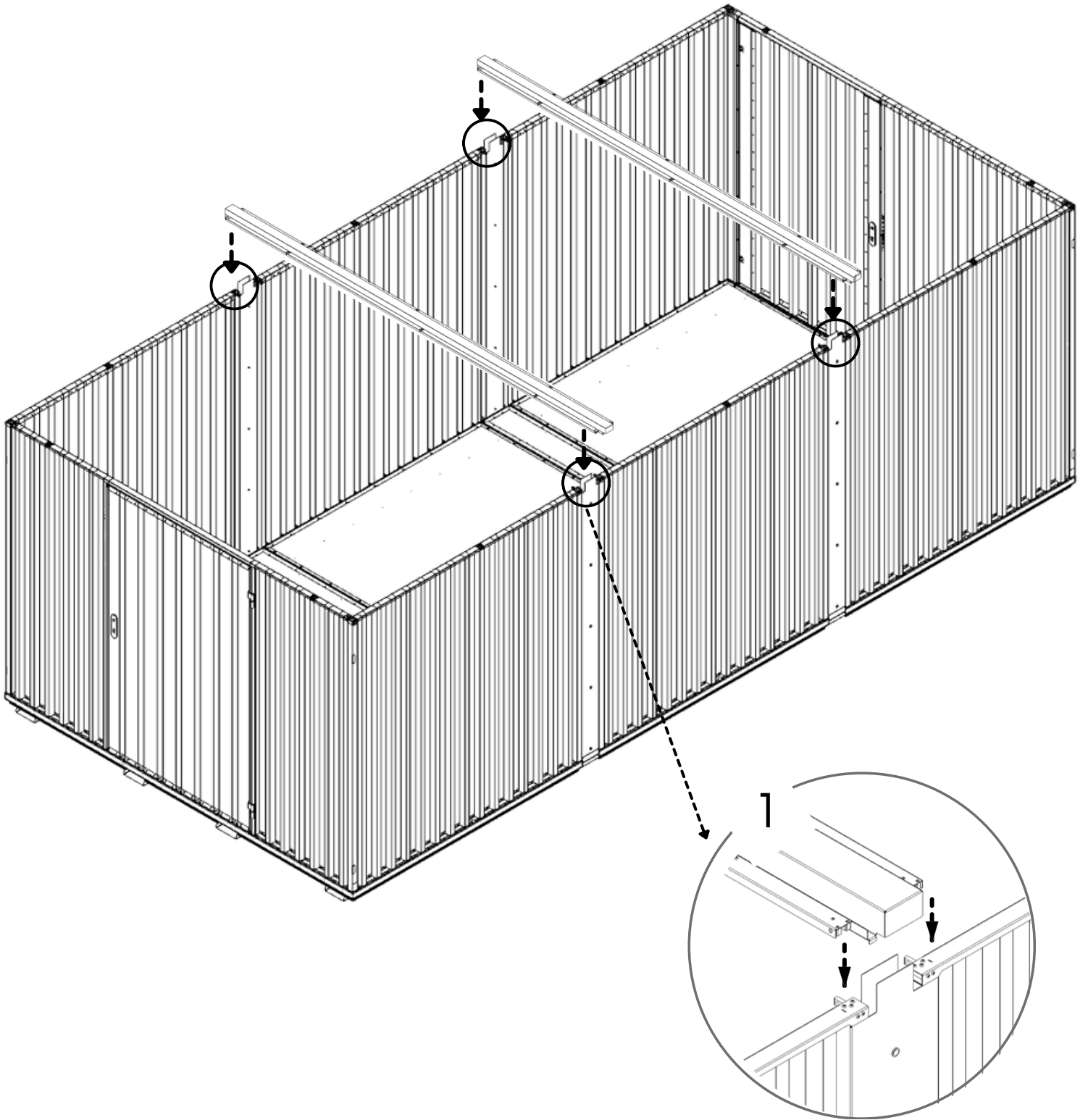



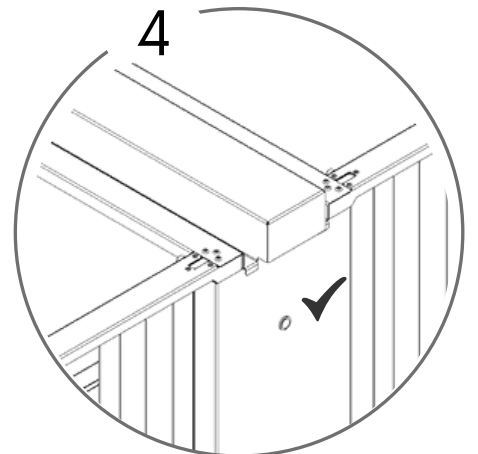
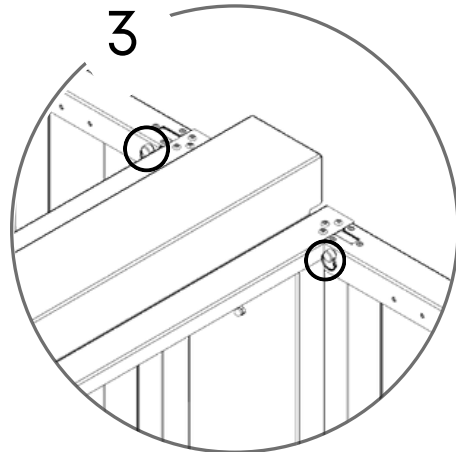
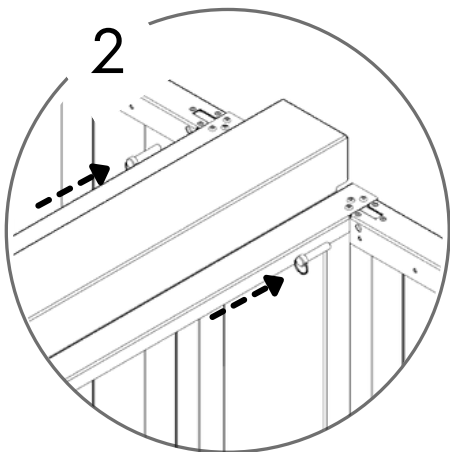
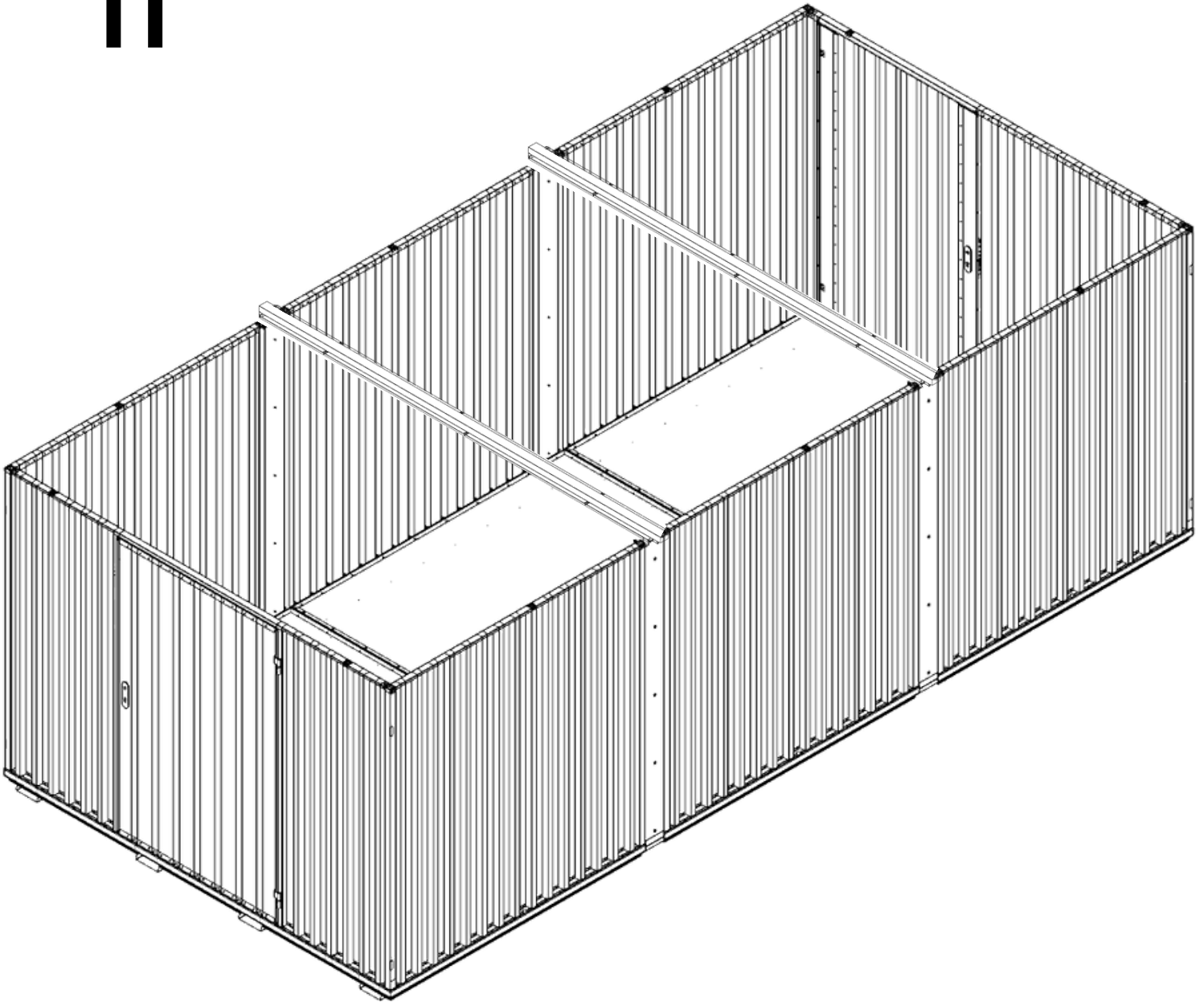

10



11





 892 KG	 1640 MM	Model Code: 3033.110.420.440 Production Tracking Code:/X09.1.3033.420.440	 9001	 14001	 50001			
---	--	---	---	--	--	---	---	---

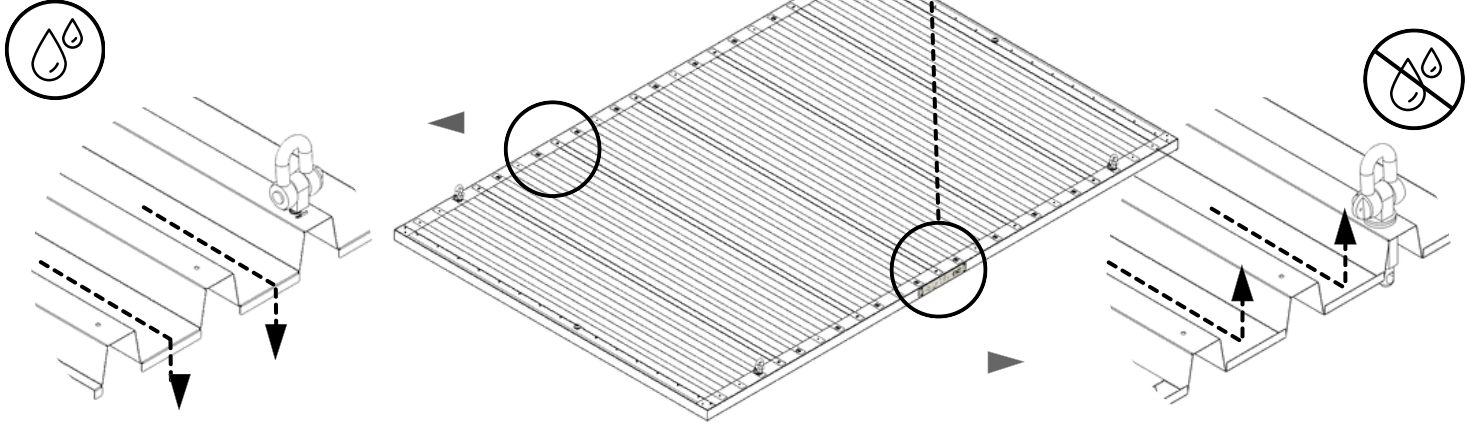

12

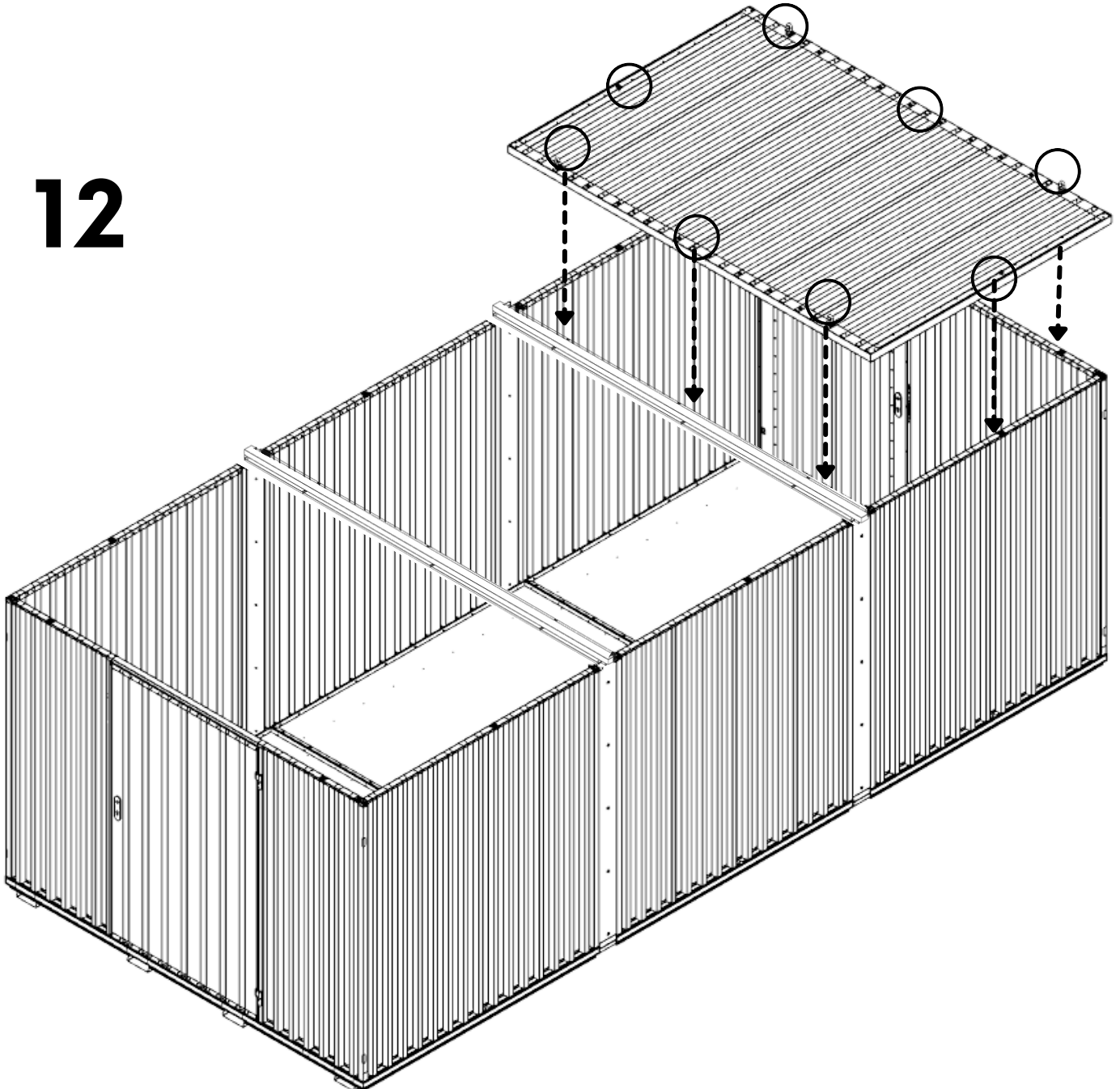

13

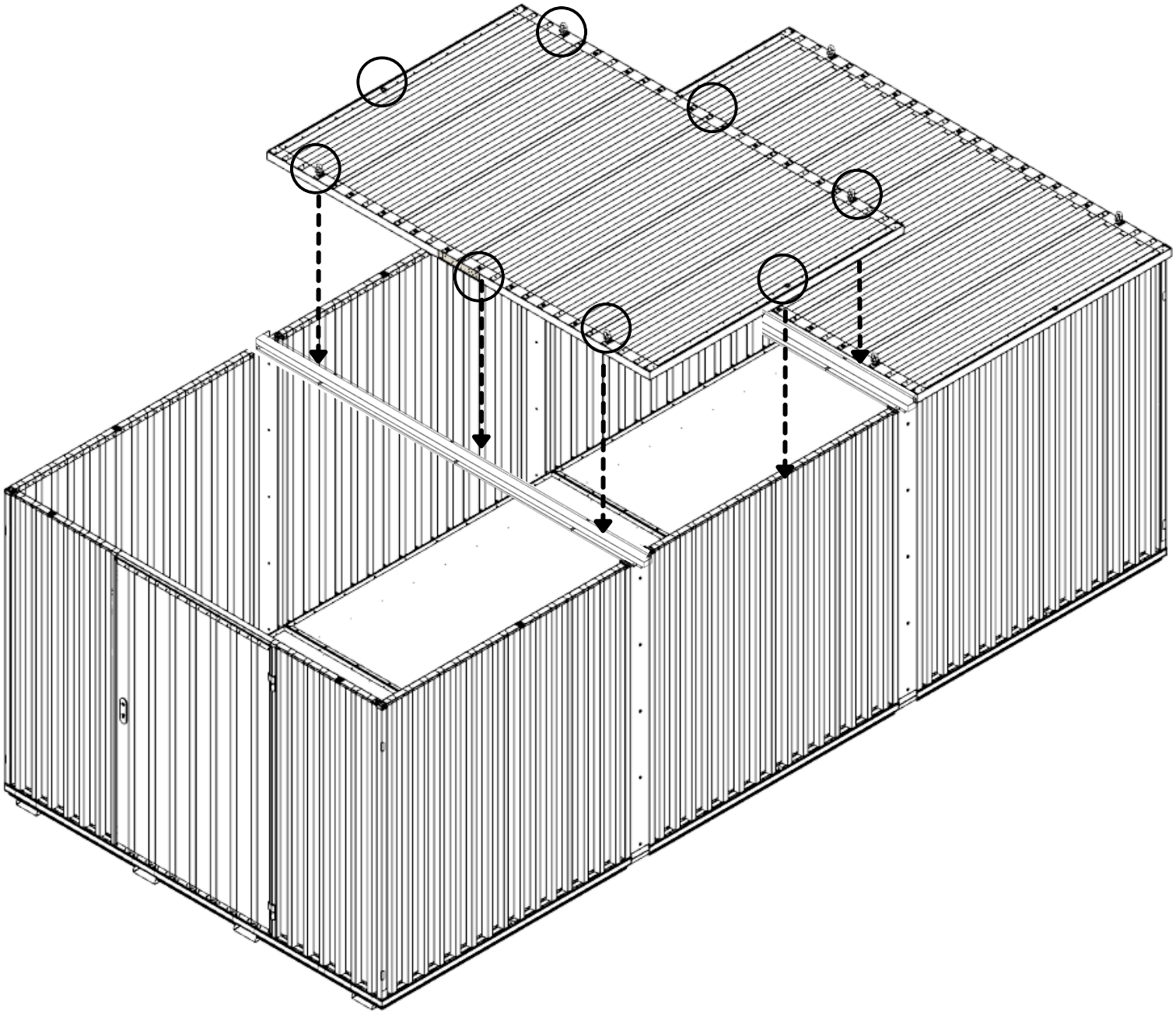

14

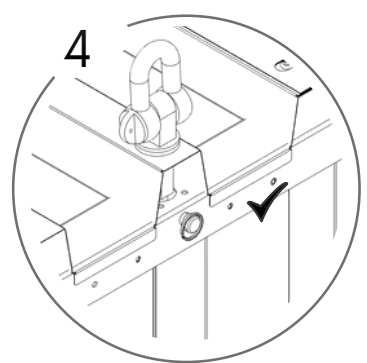
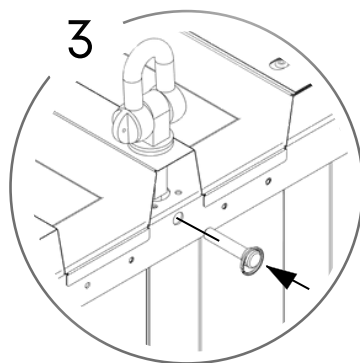
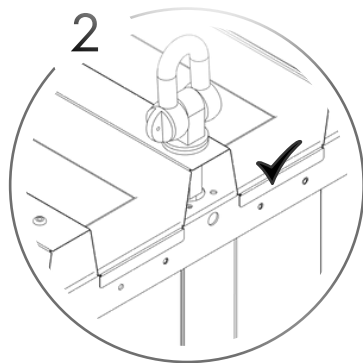
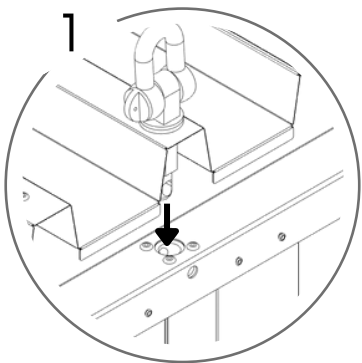
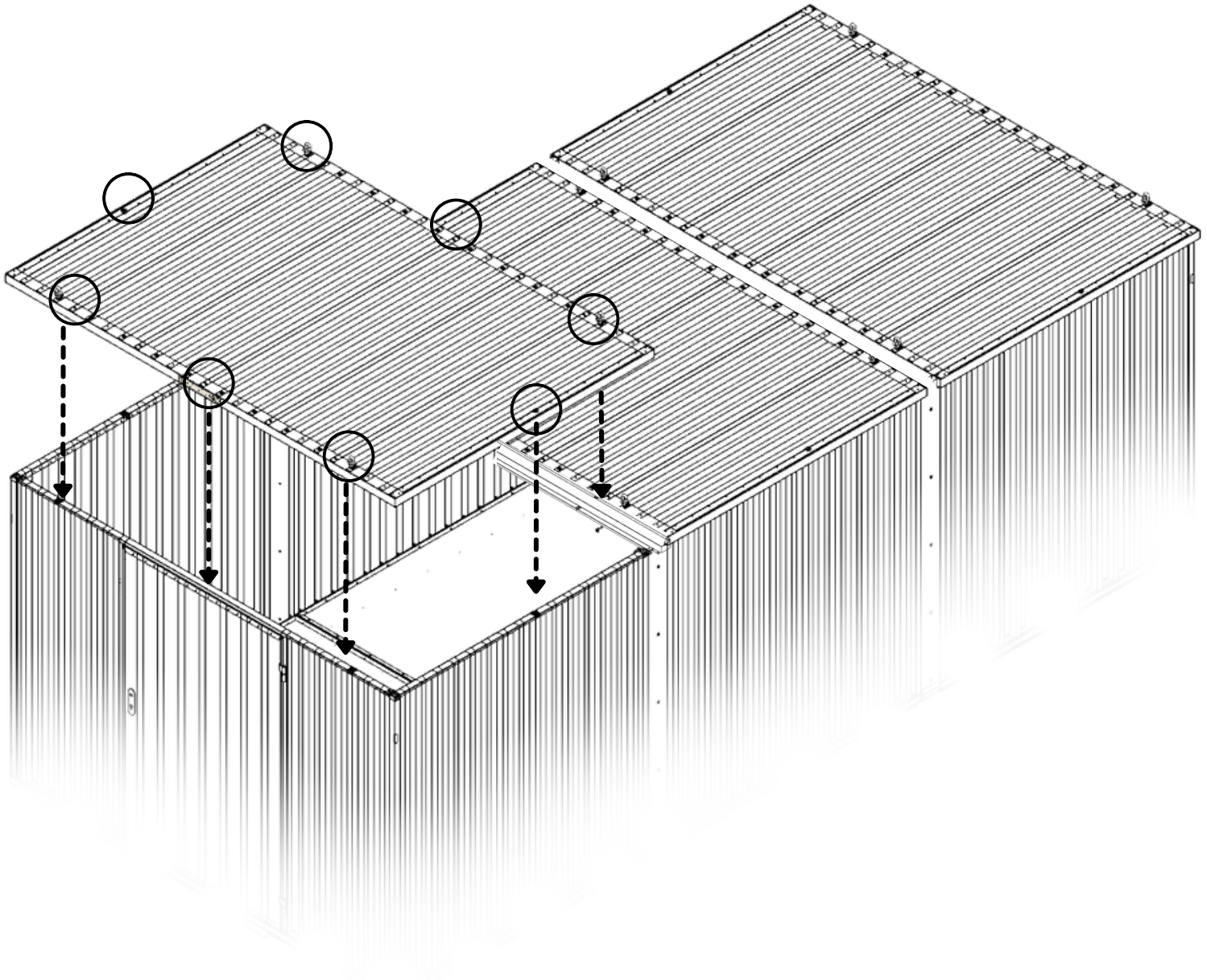

15

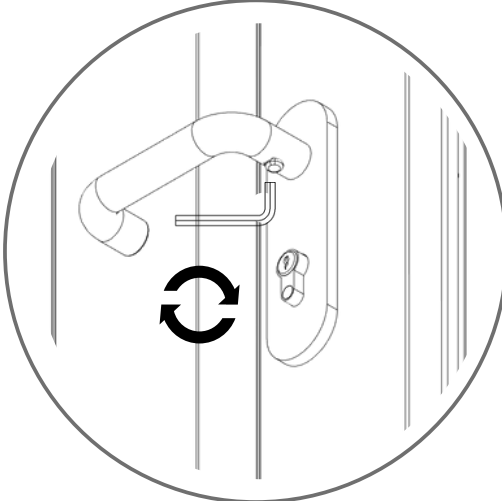
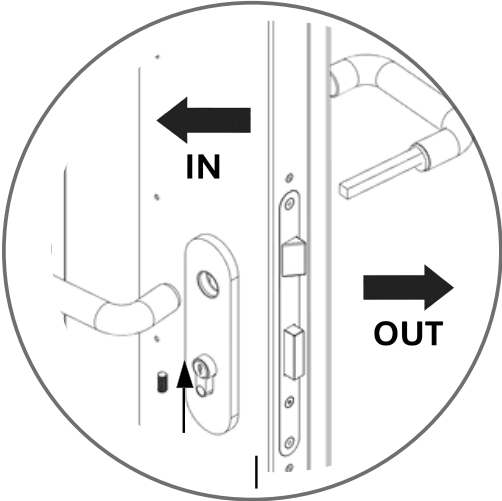
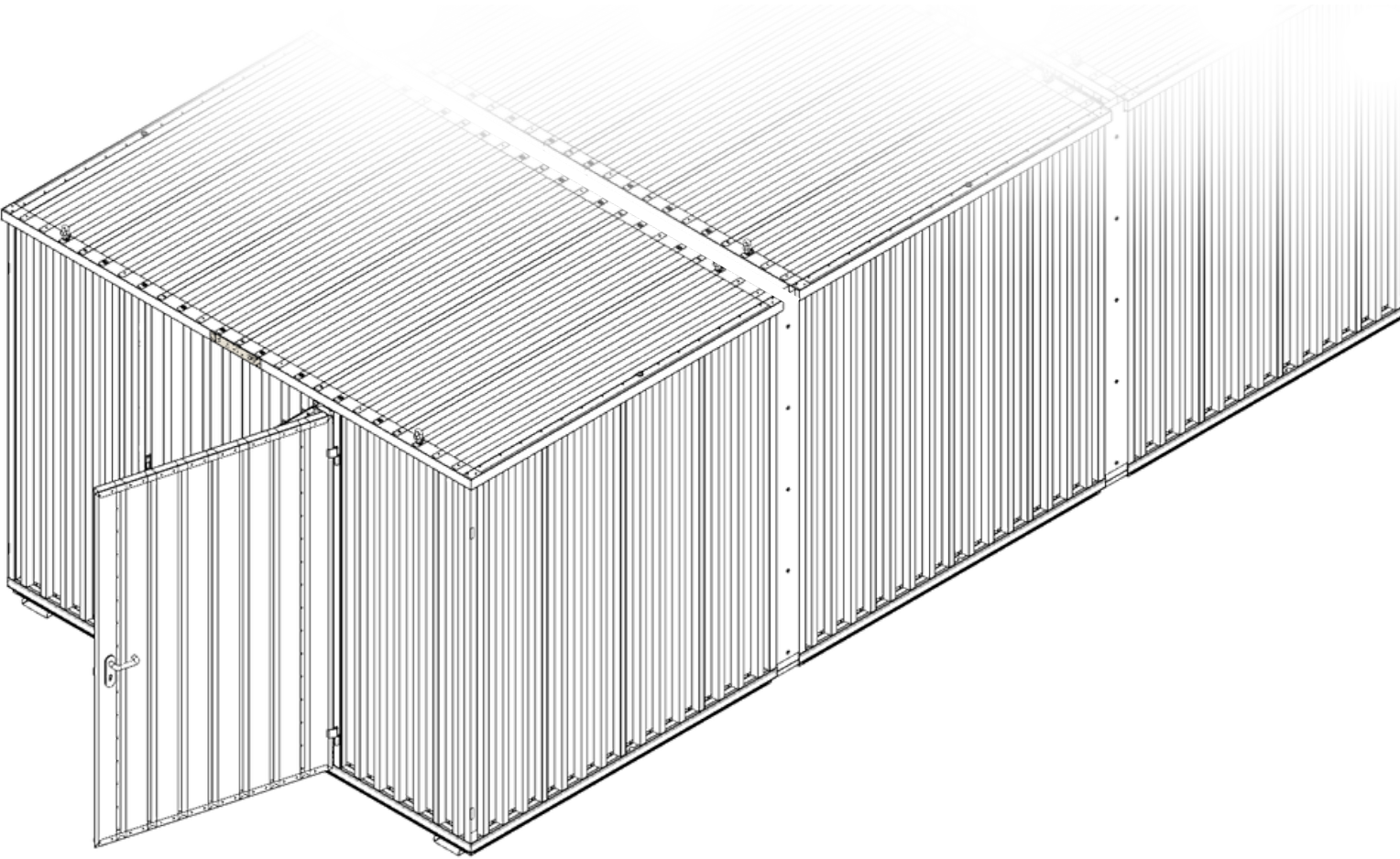

16

