

PRODUCT CODE:50.110.320

prefabase
Quick Build Solutions

Instructions and User Guide

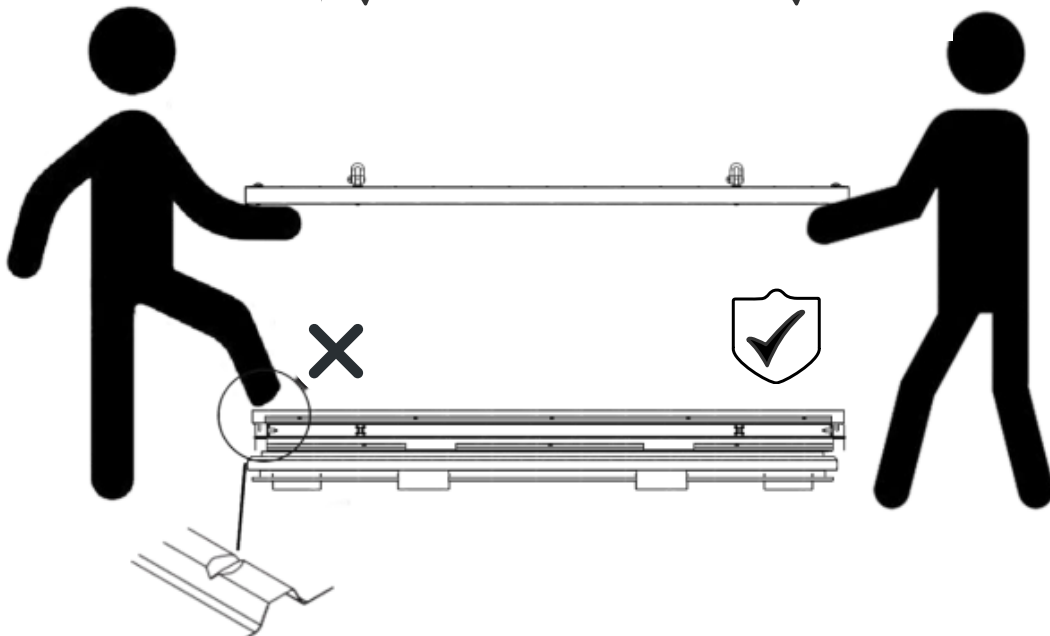
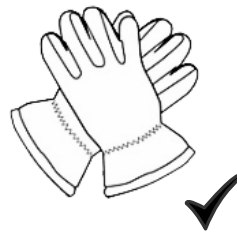

50.0110
1x

50.0510
1x

50.0410
2x

0310
1x

0320
1x

61.101
4x

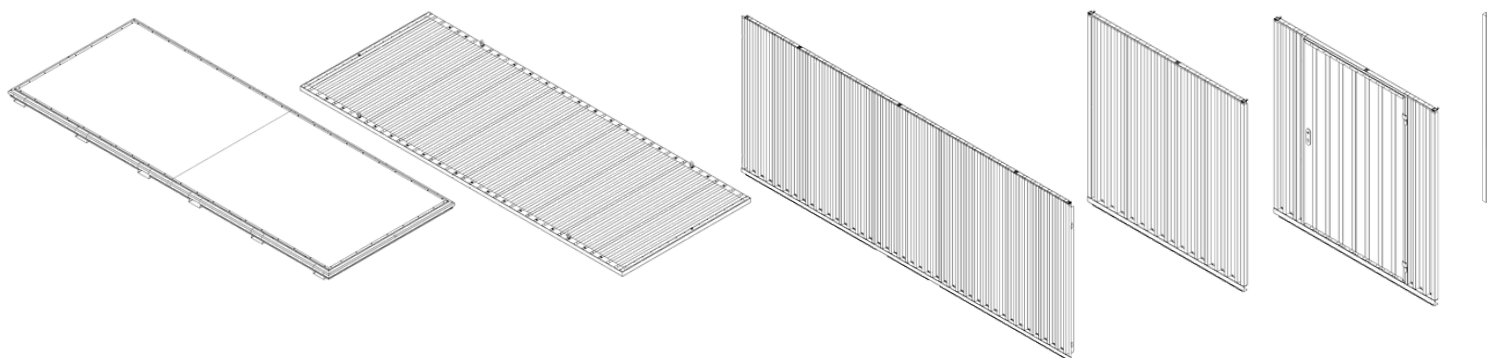

12x

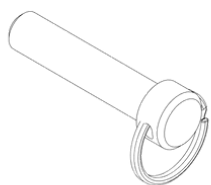

1x

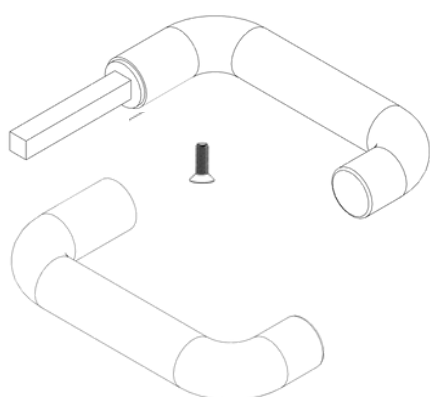

1x

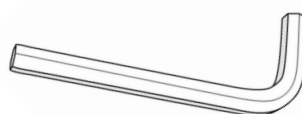

1x



1

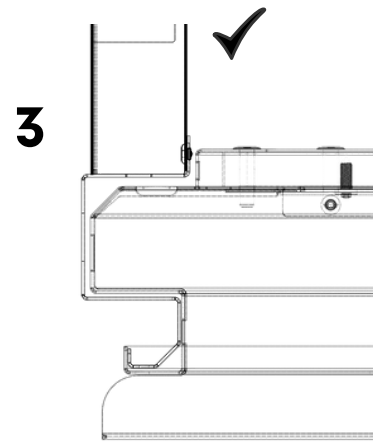
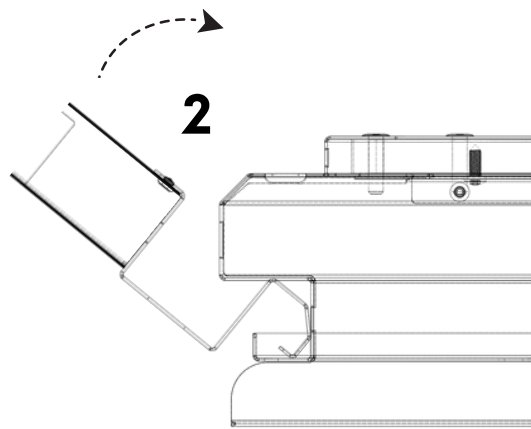
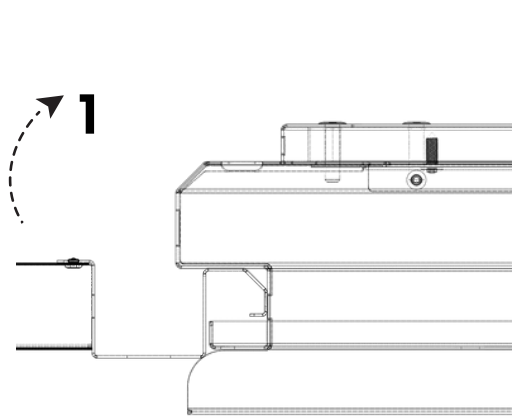
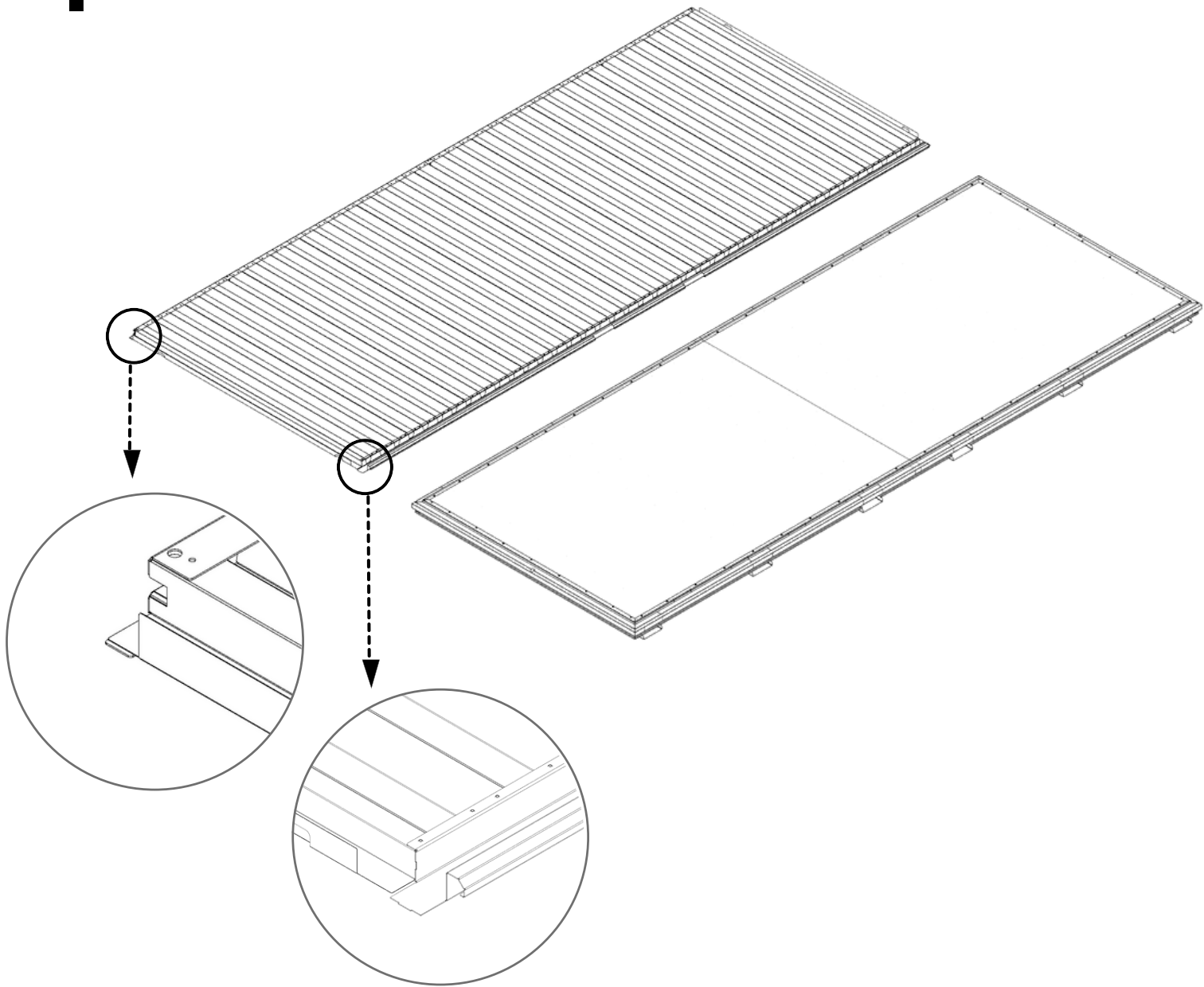

2

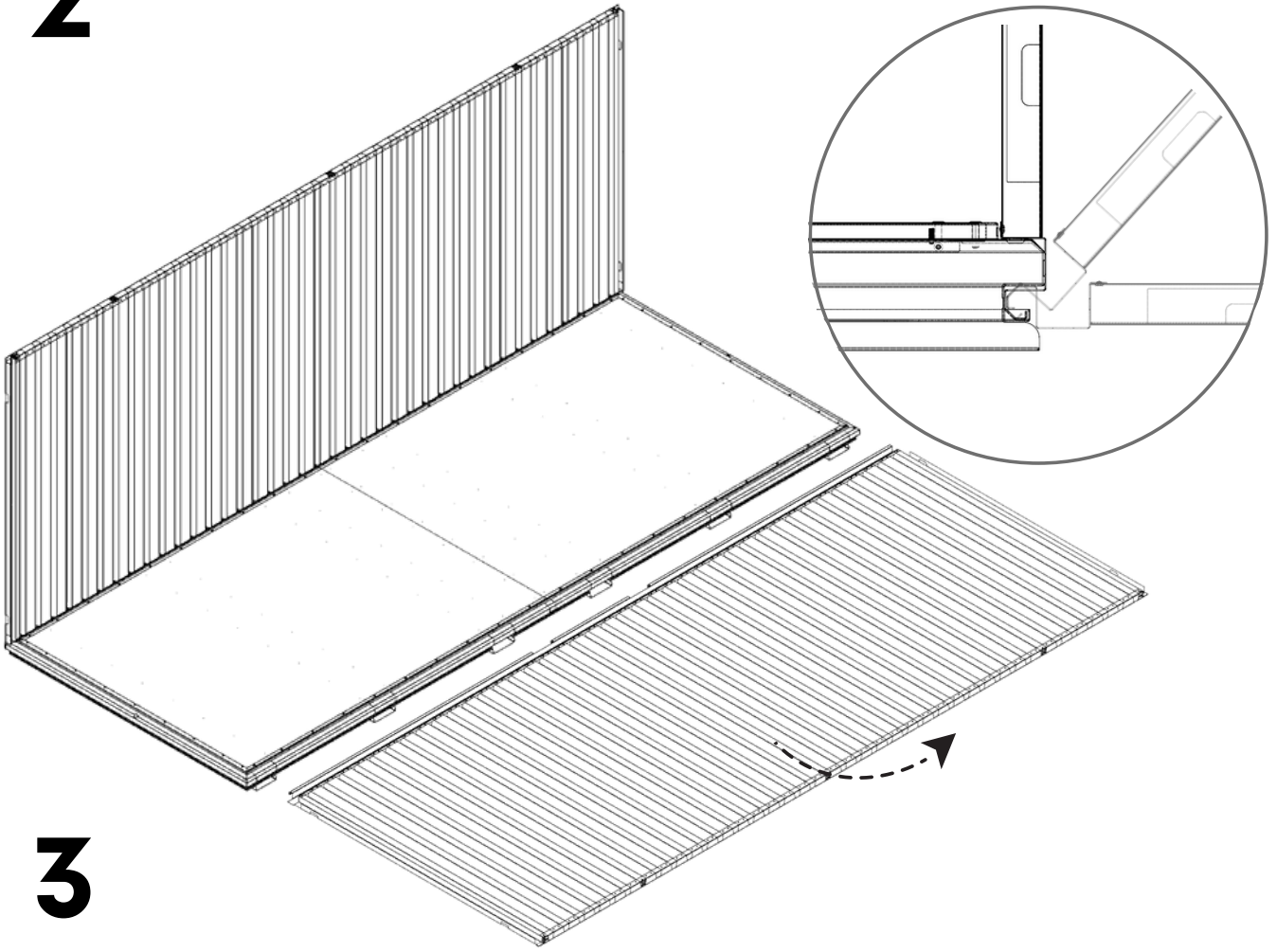

3

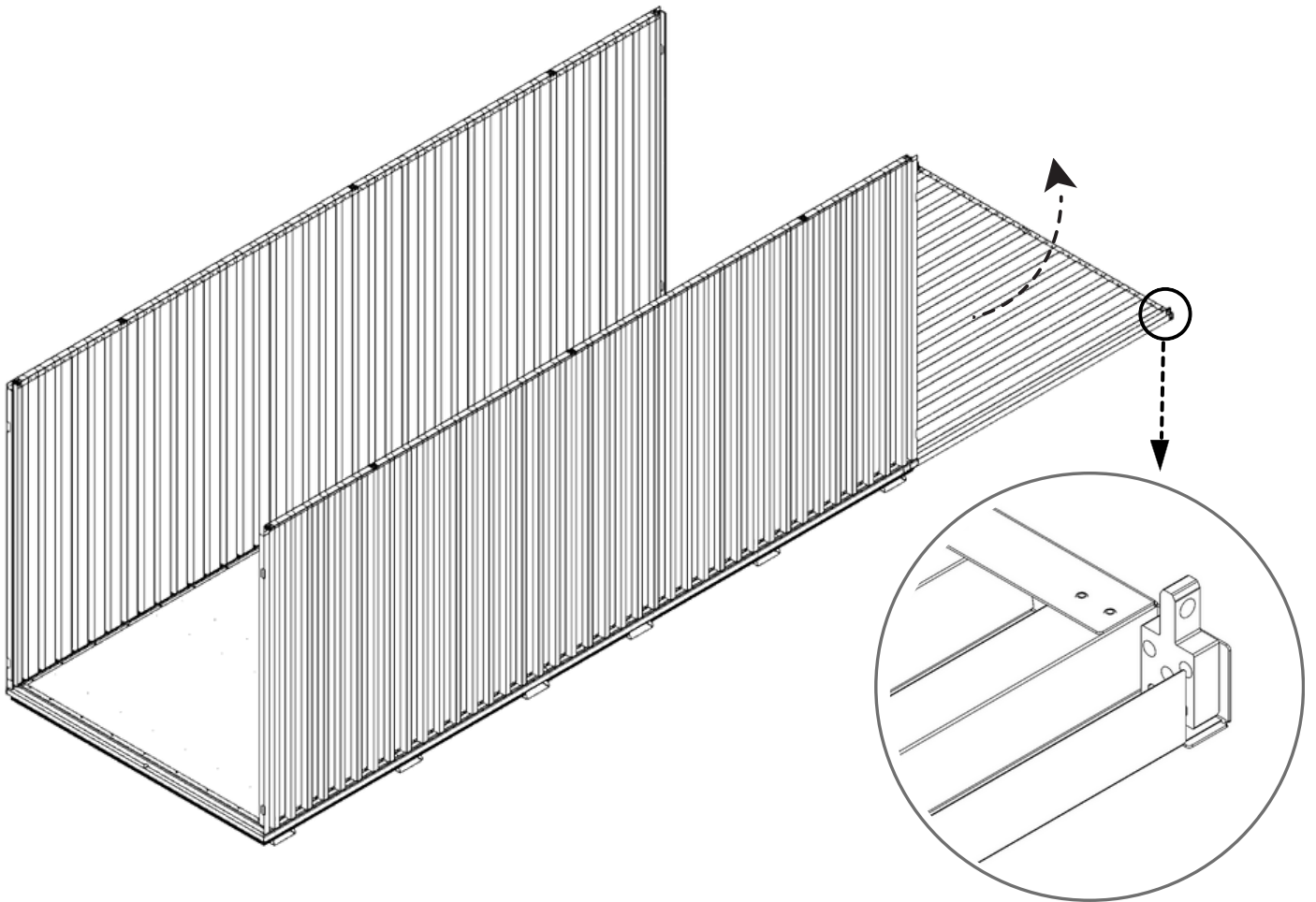

3.1

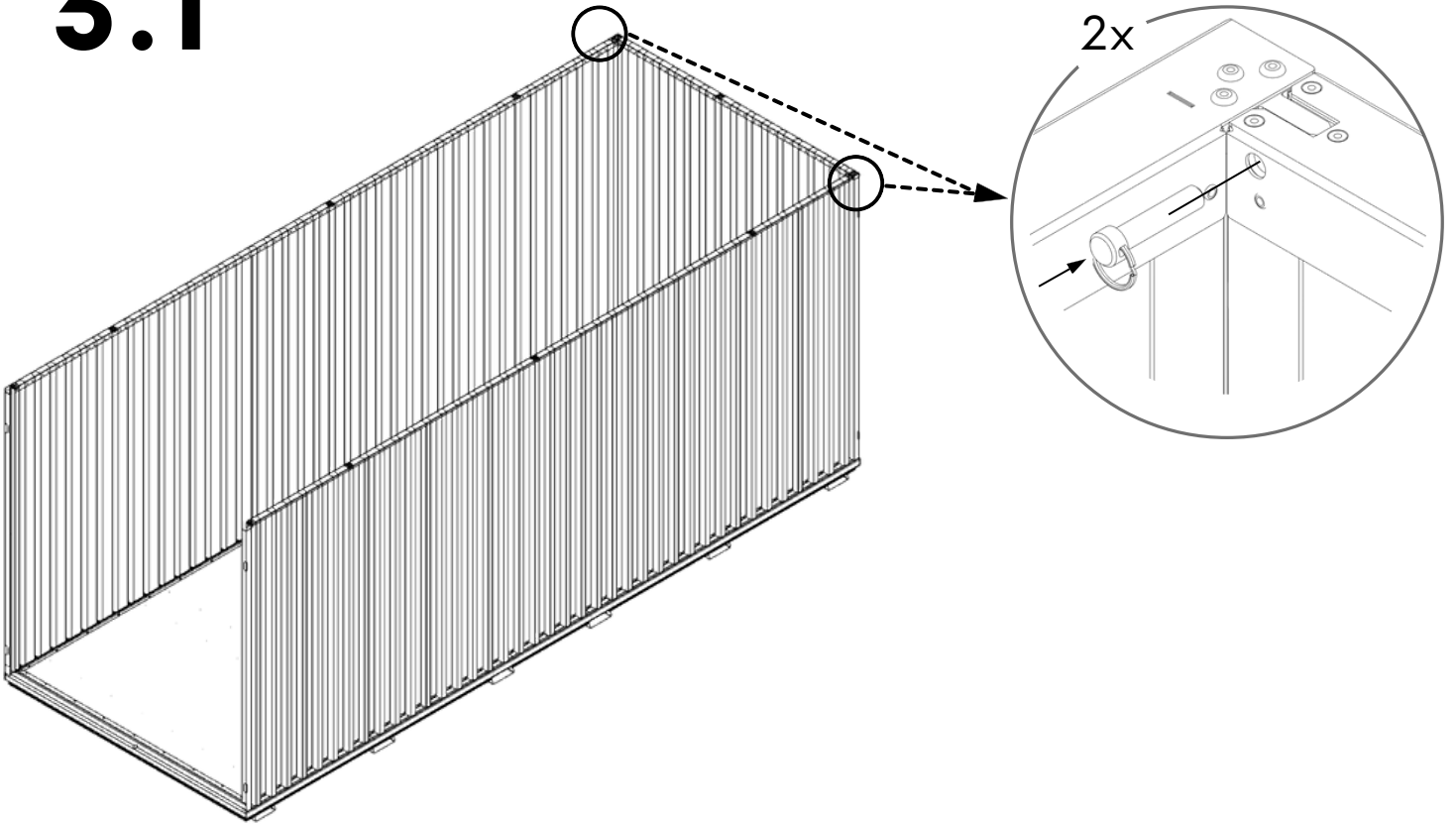



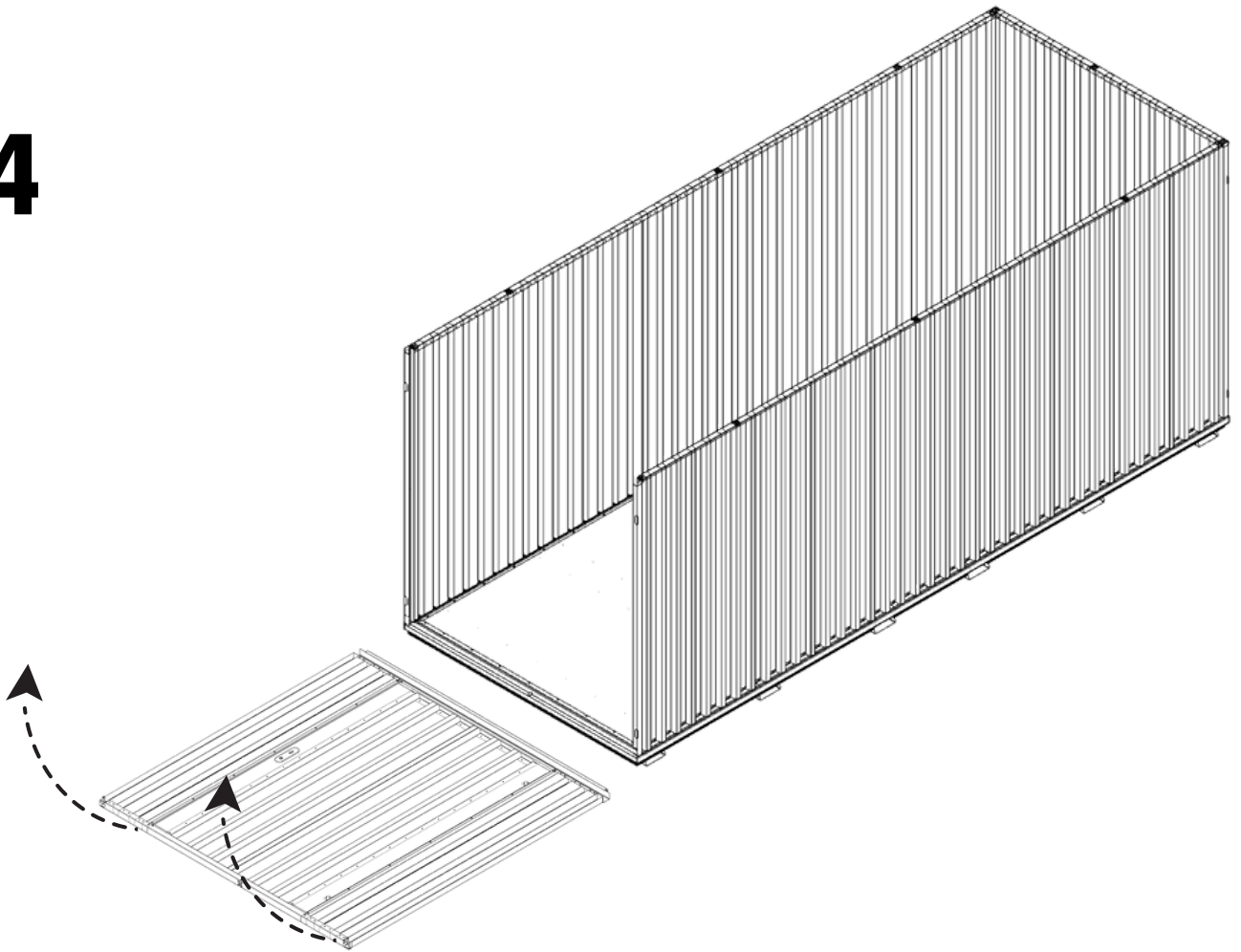



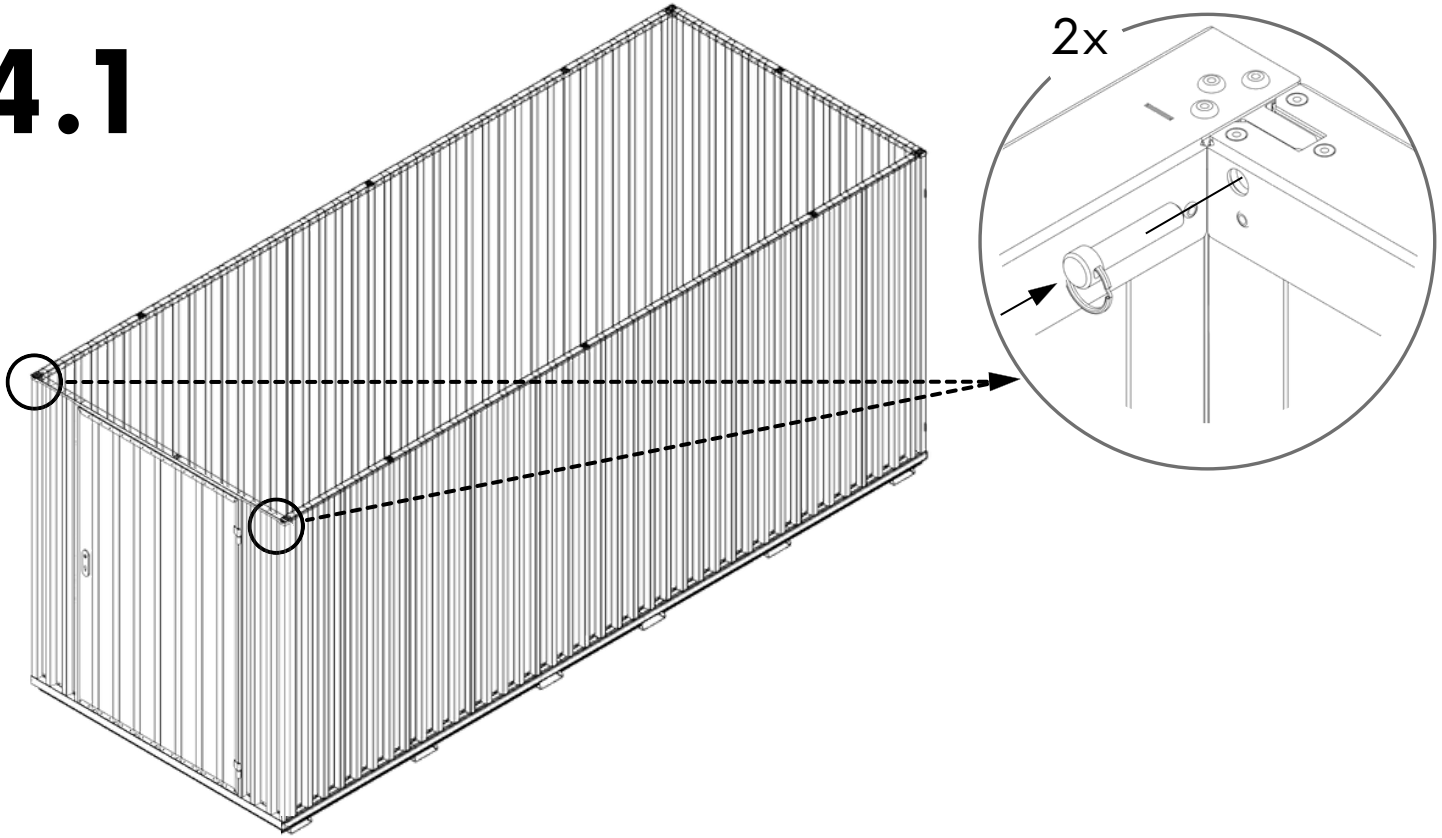

4



4.1



 492 KG	 1640 MM	Model Code: 50.110.320 Production Tracking Code: /X09.1.50.320    9001 14001 50001	 	
---	--	---	---	---

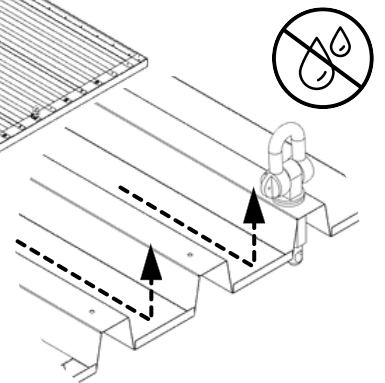
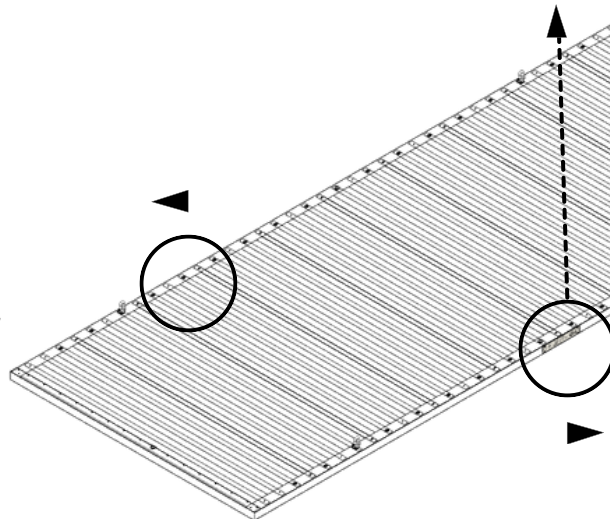
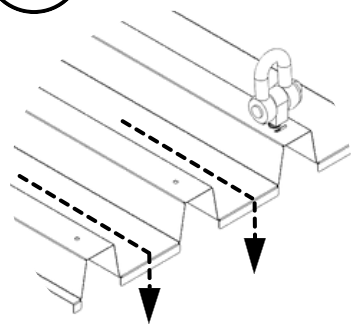

5

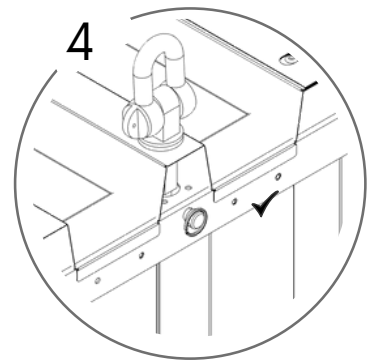
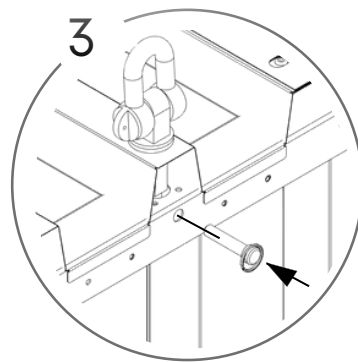
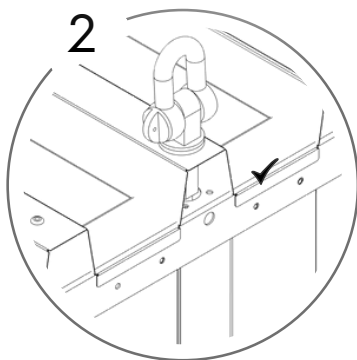
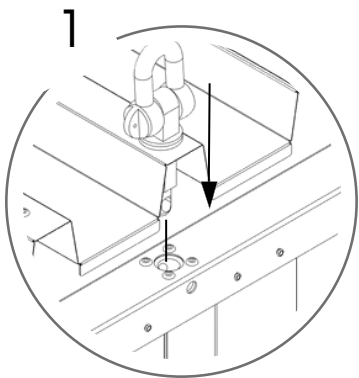
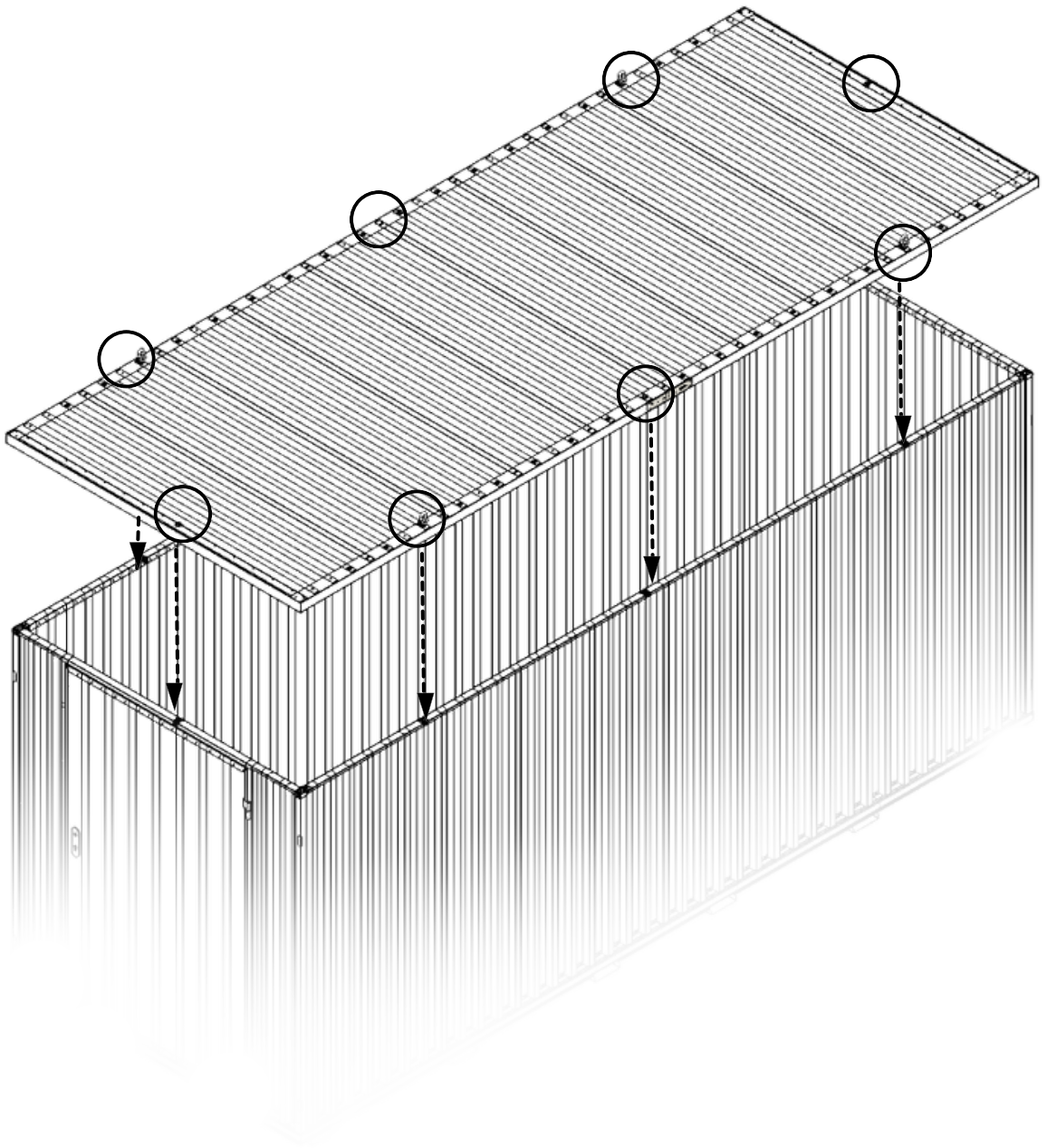

6

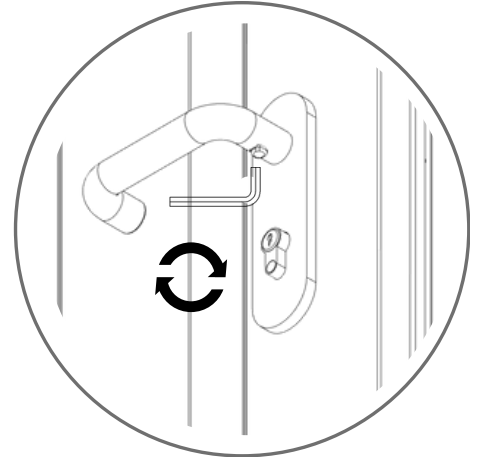
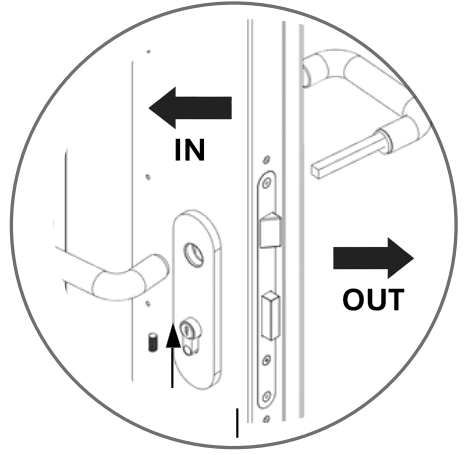
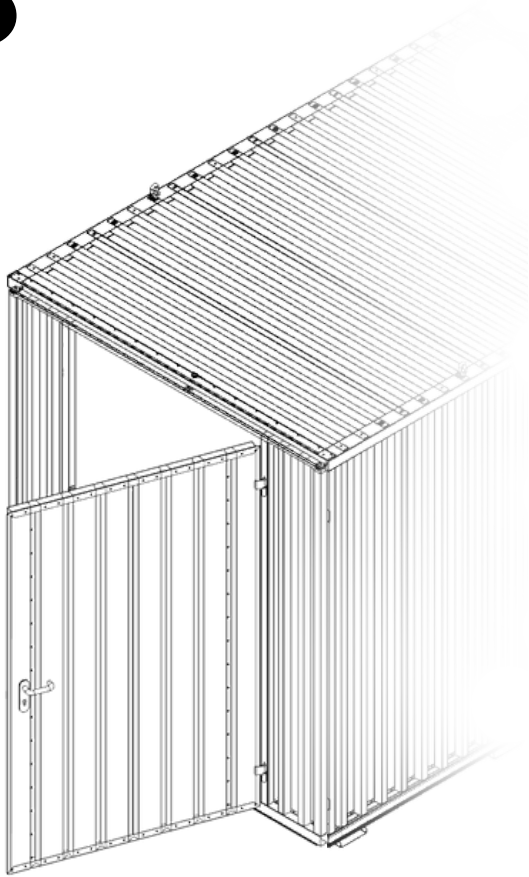

7

