

PRODUCT CODE:4044.110.420.440

prefabase
Quick Build Solutions

Instructions and User Guide

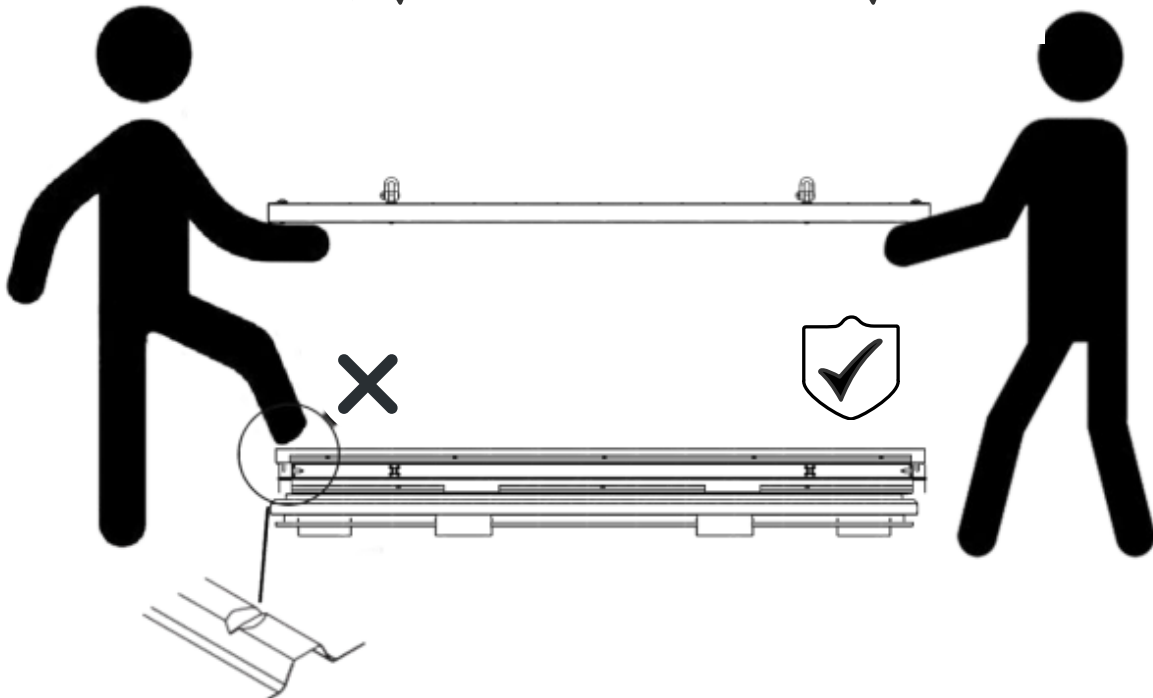
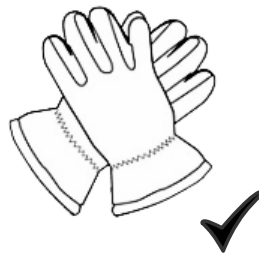

40.0110

3x

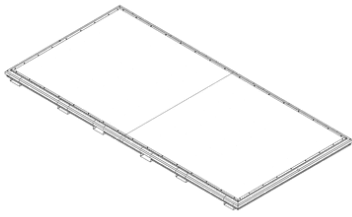

40.0510

3x

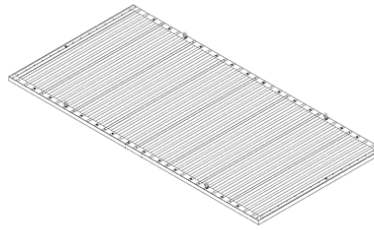

404.0110

2x



404.0510

2x



40.0420

1x

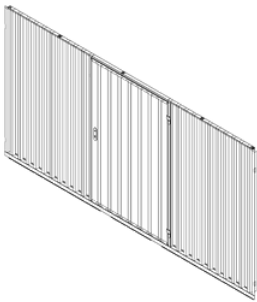

40.0440

1x

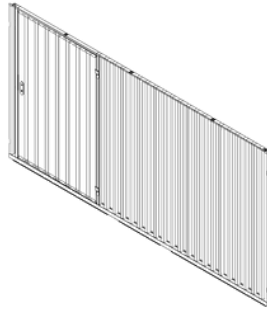

0310

6x

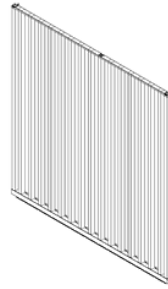

305.20.08

4x



305.20.09

4x



61.101

4x



36x

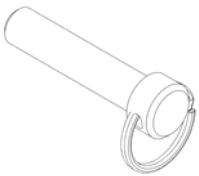

2x

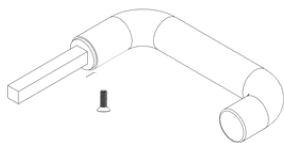

20x



20x



20x



1x



2x



1

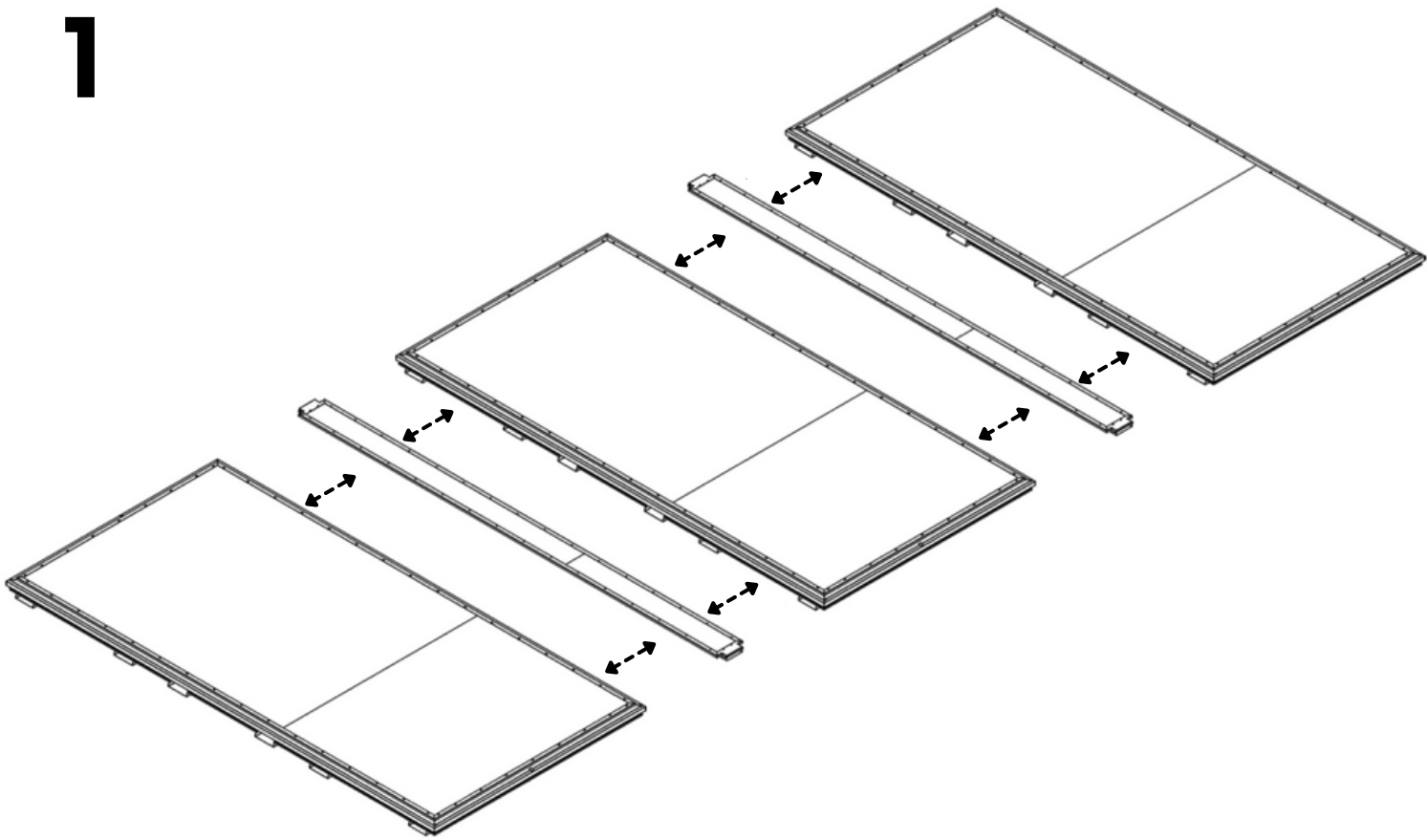

2

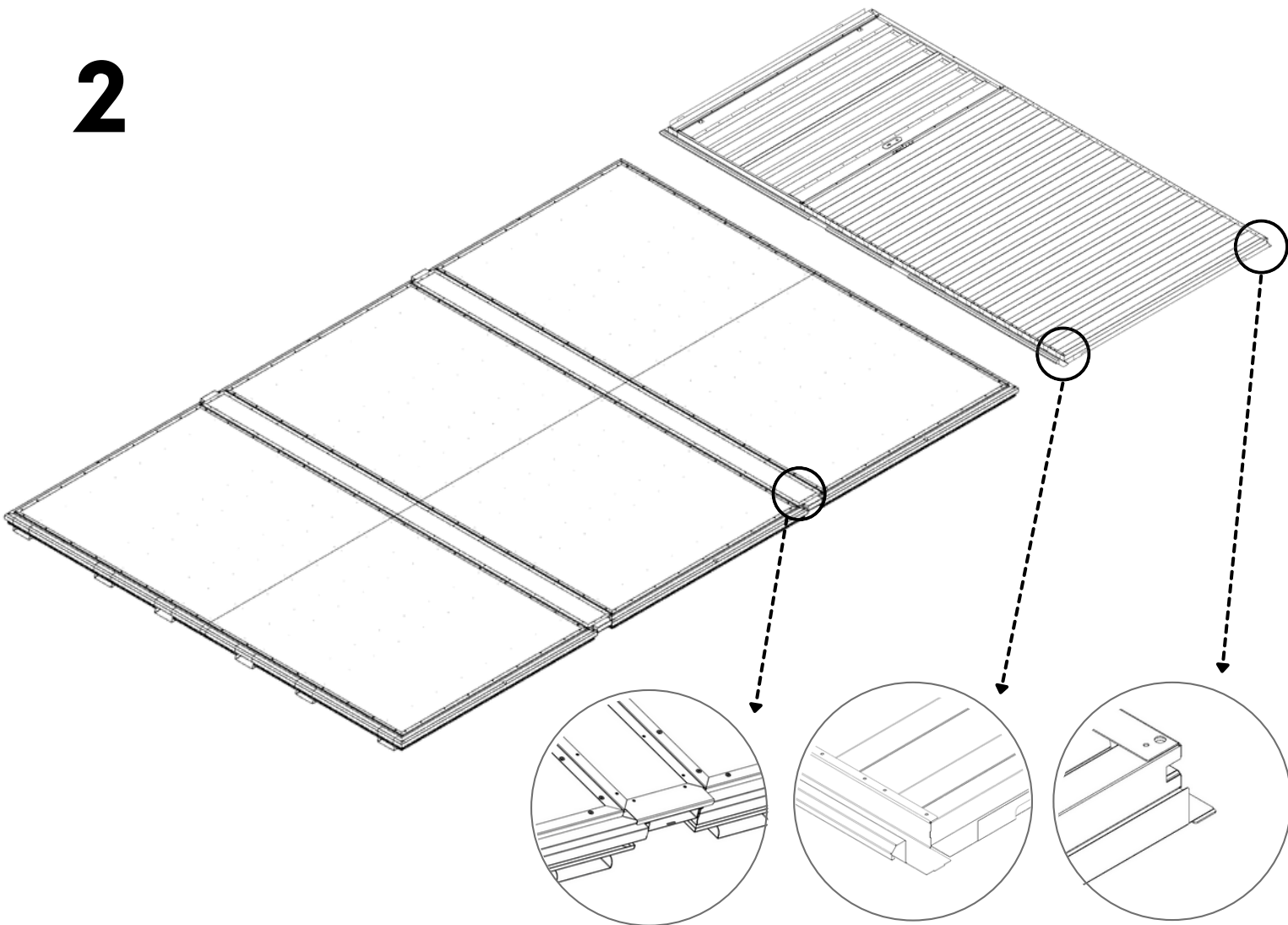

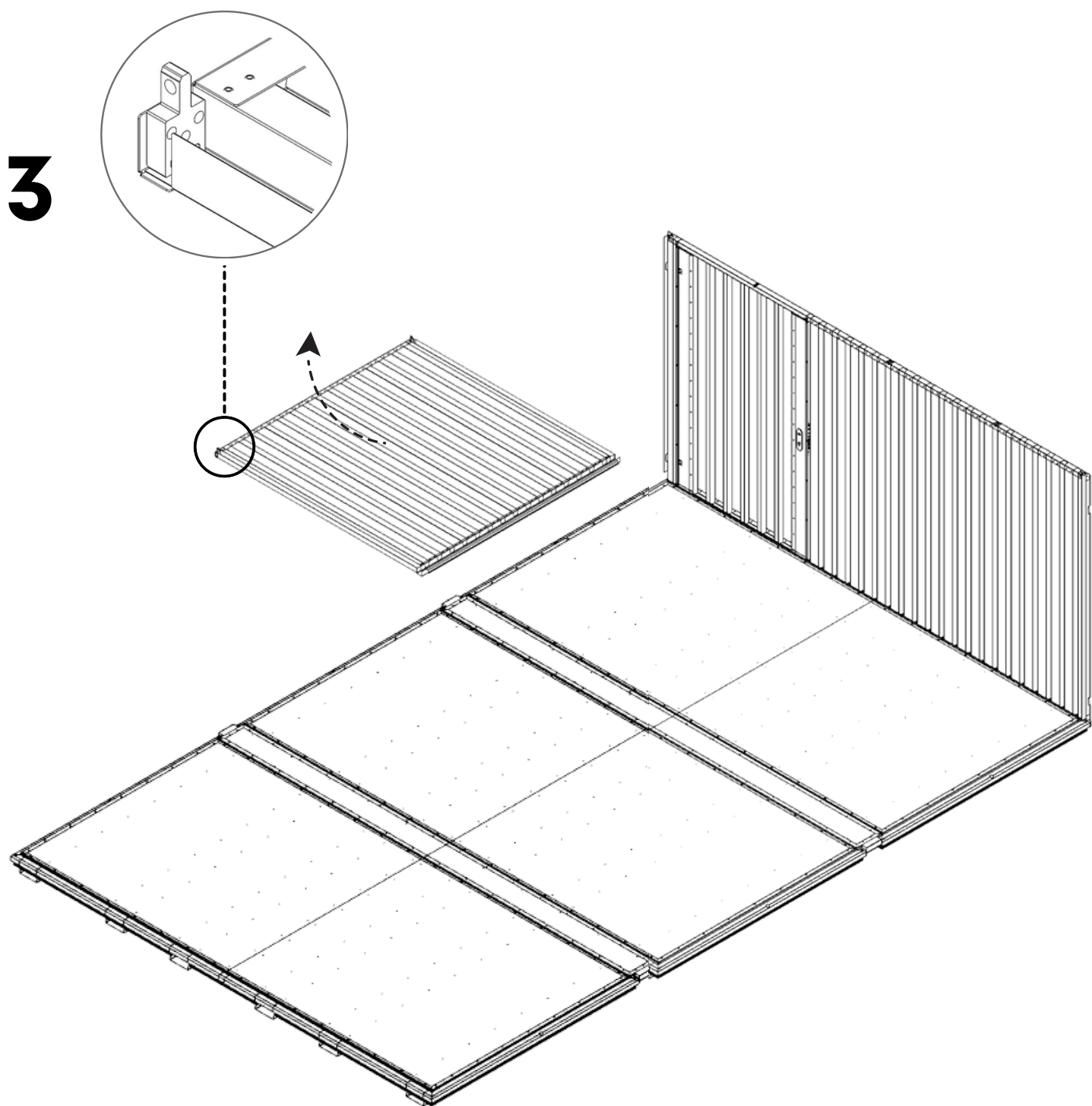
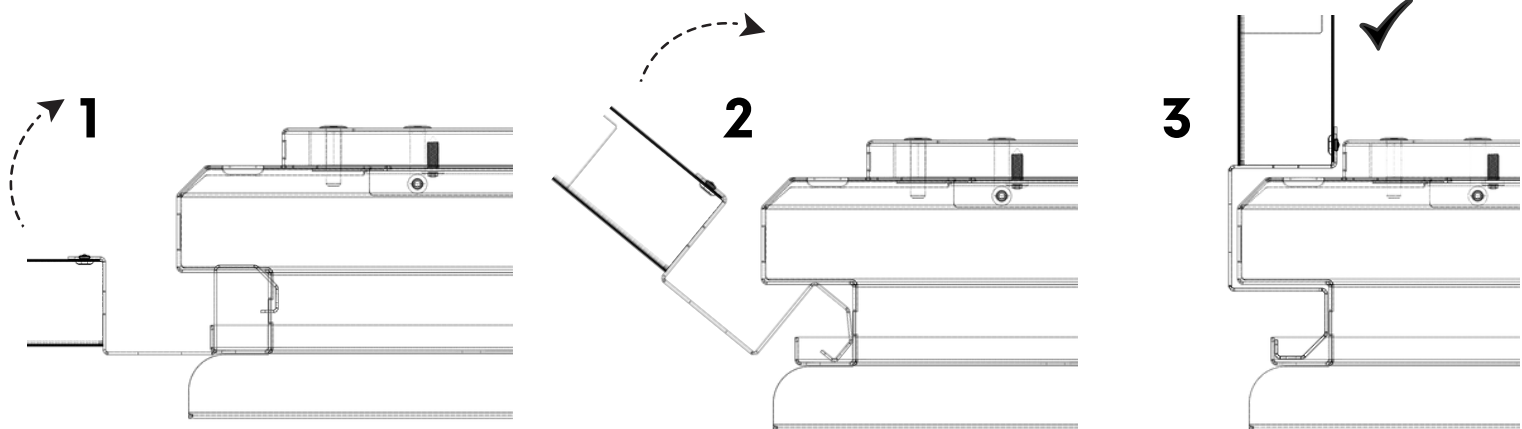

4

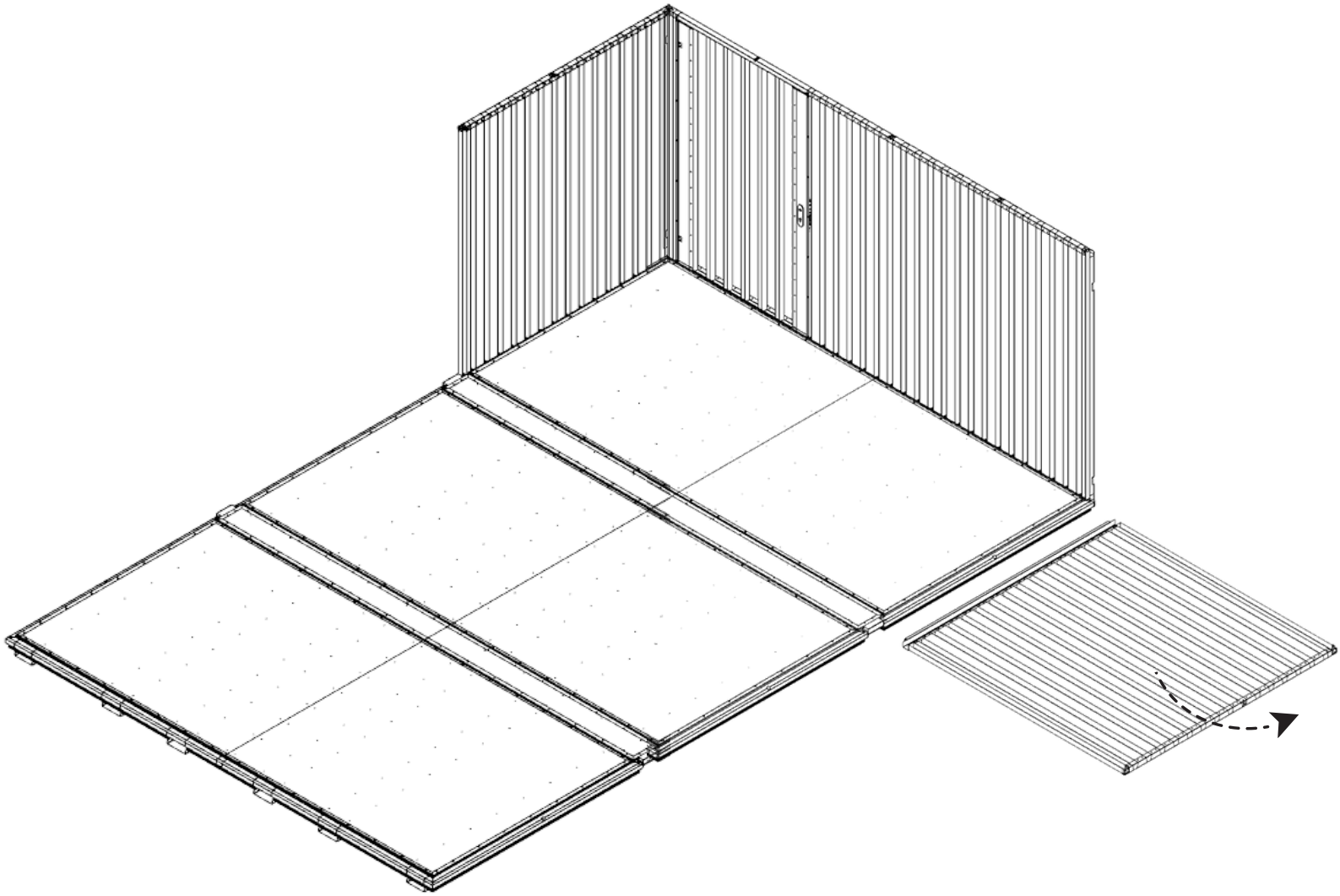

4.1

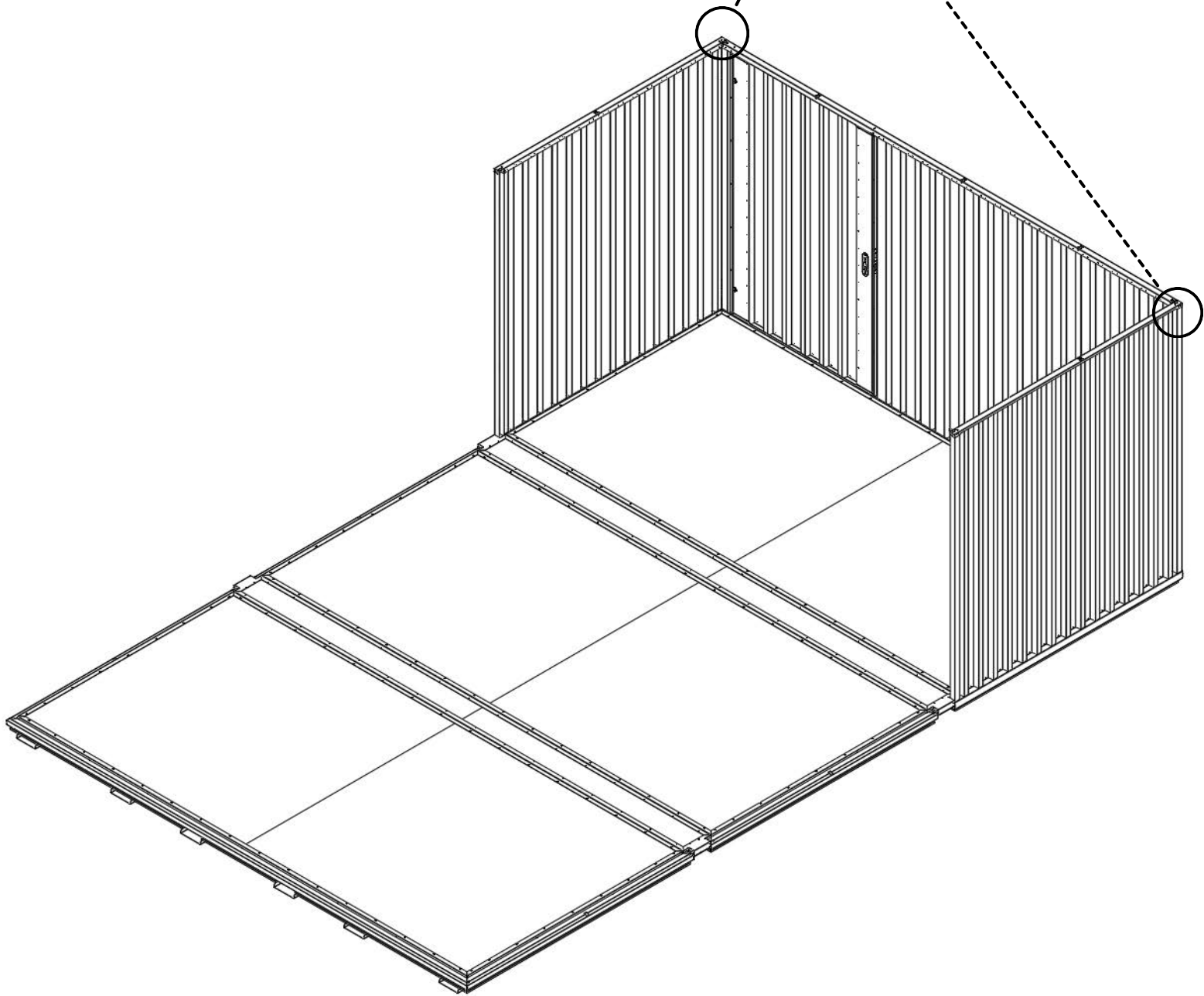
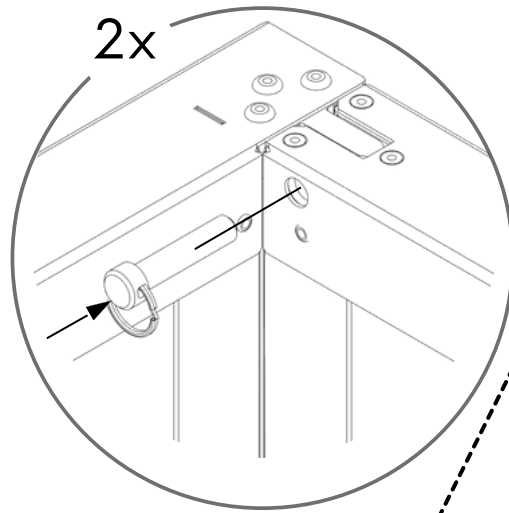

5

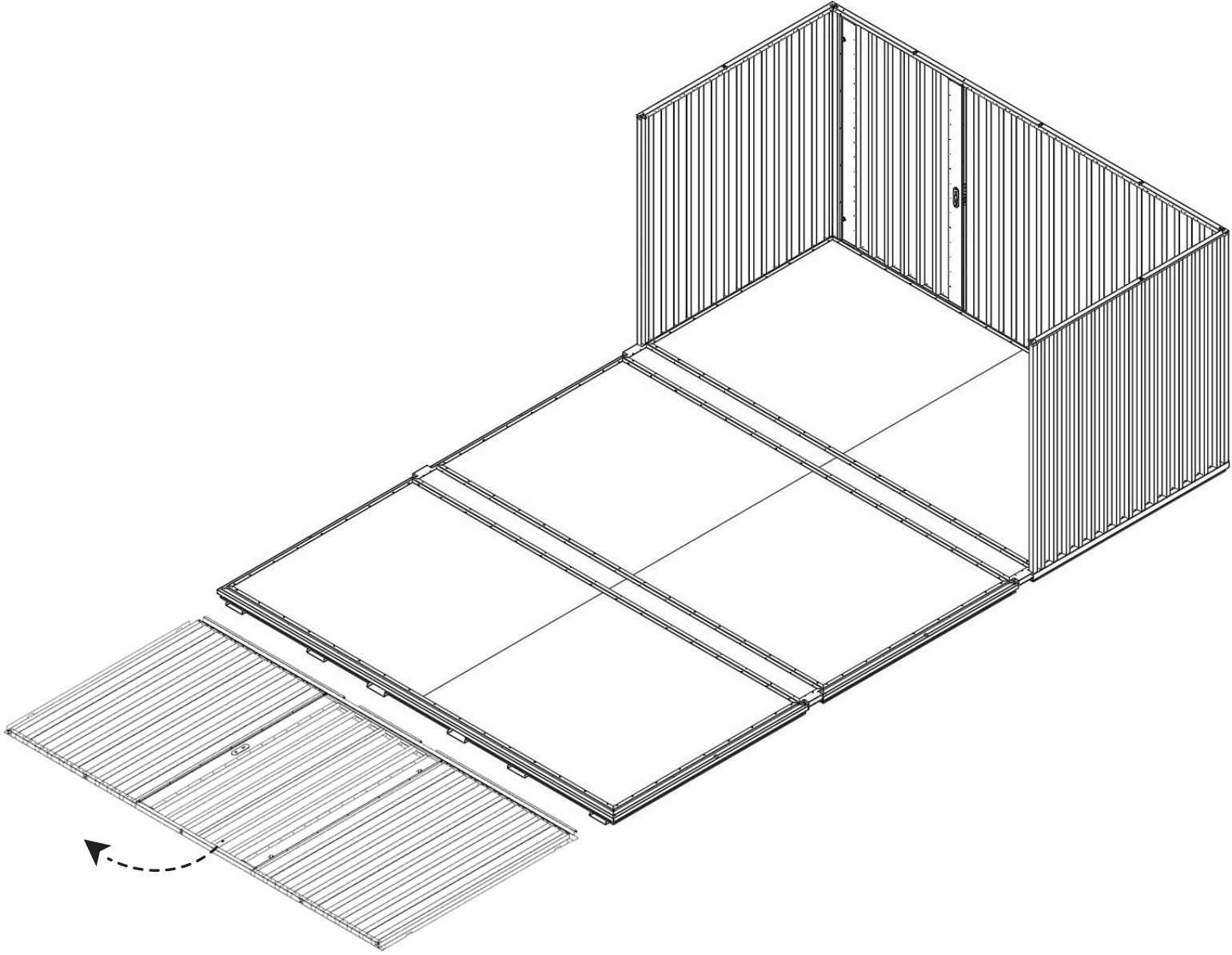

6

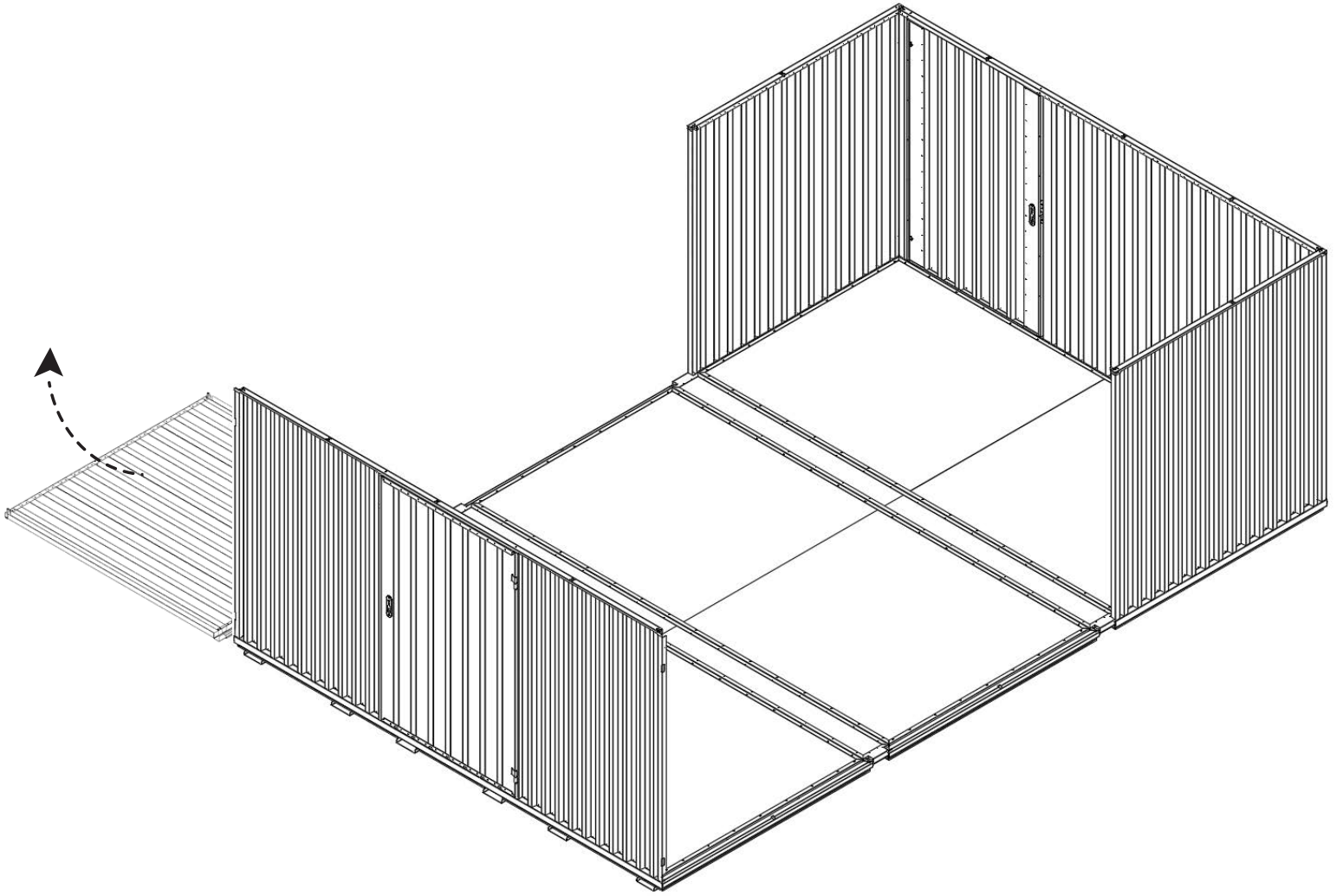

7

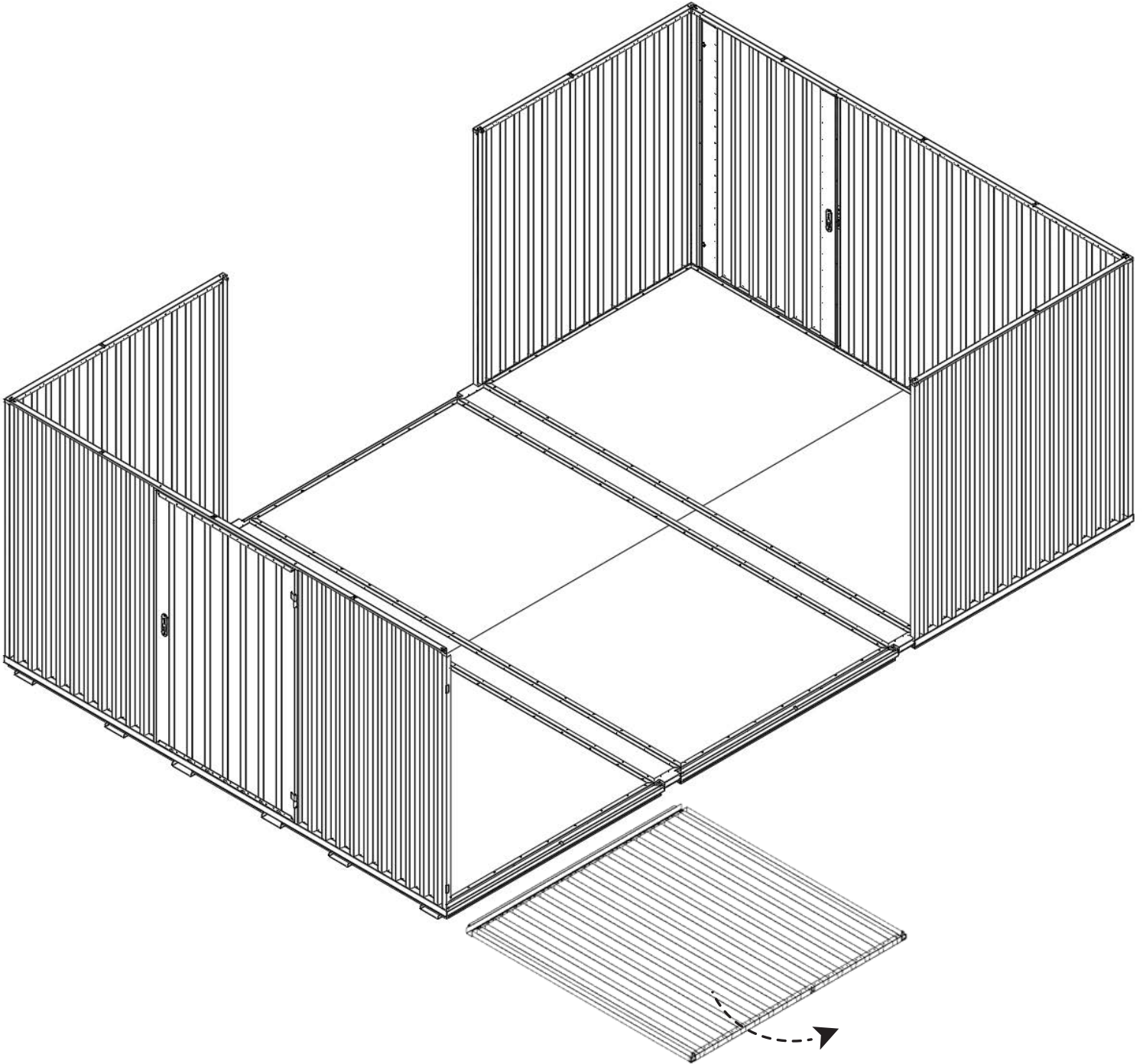

7.1

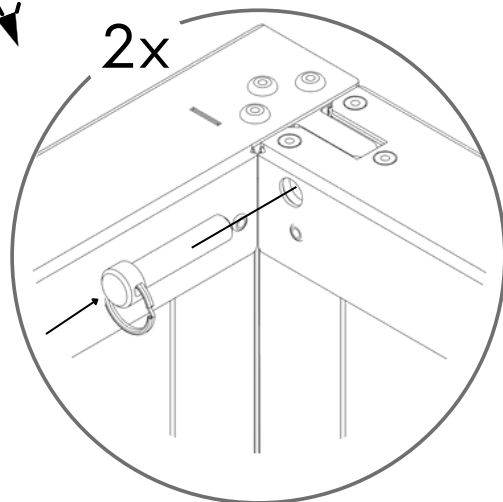
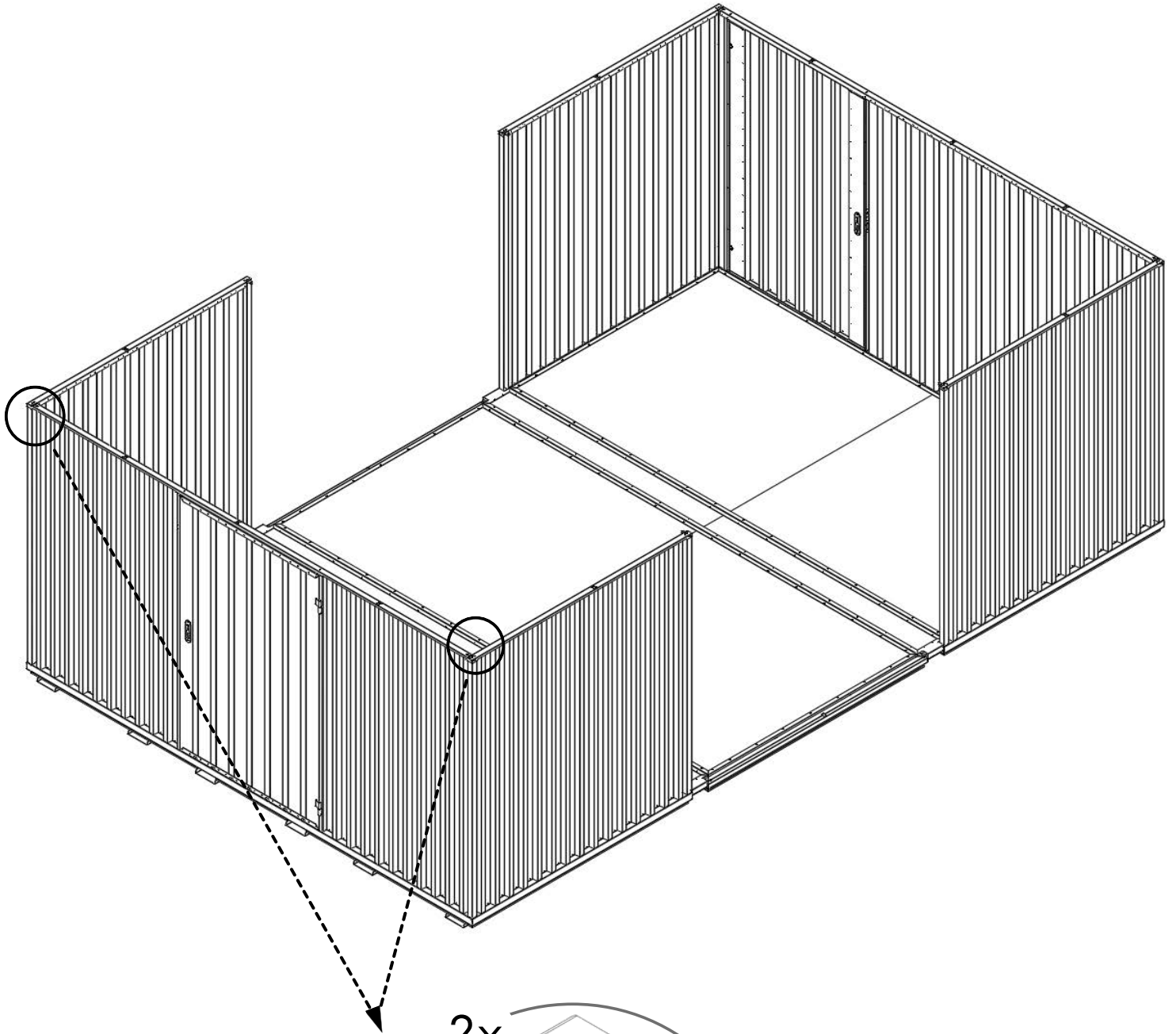

8

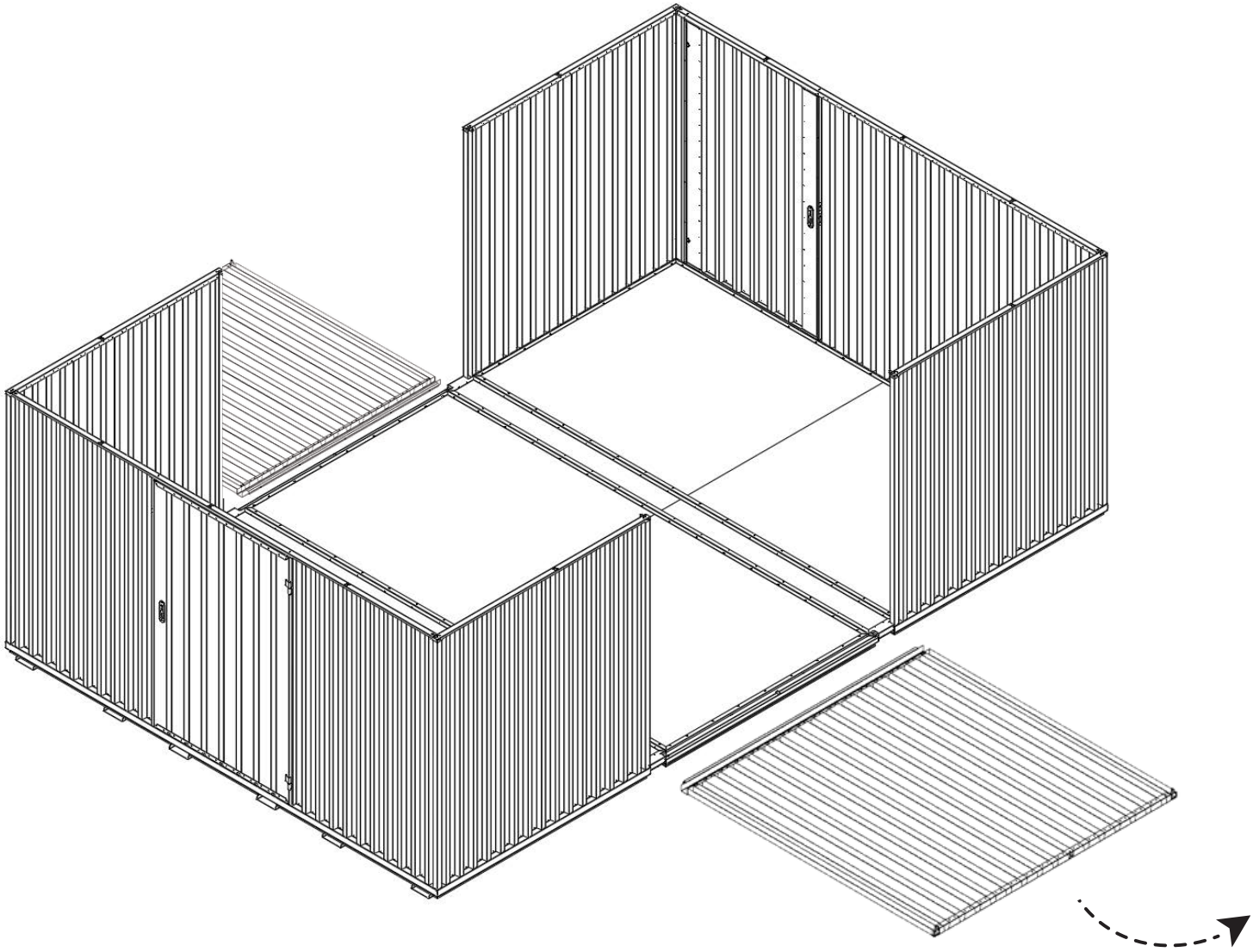

9

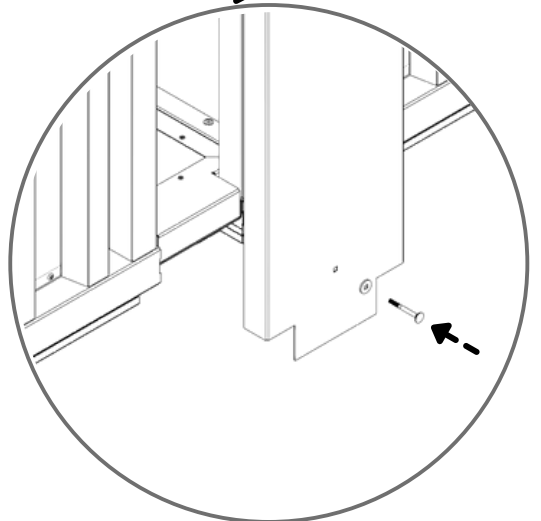
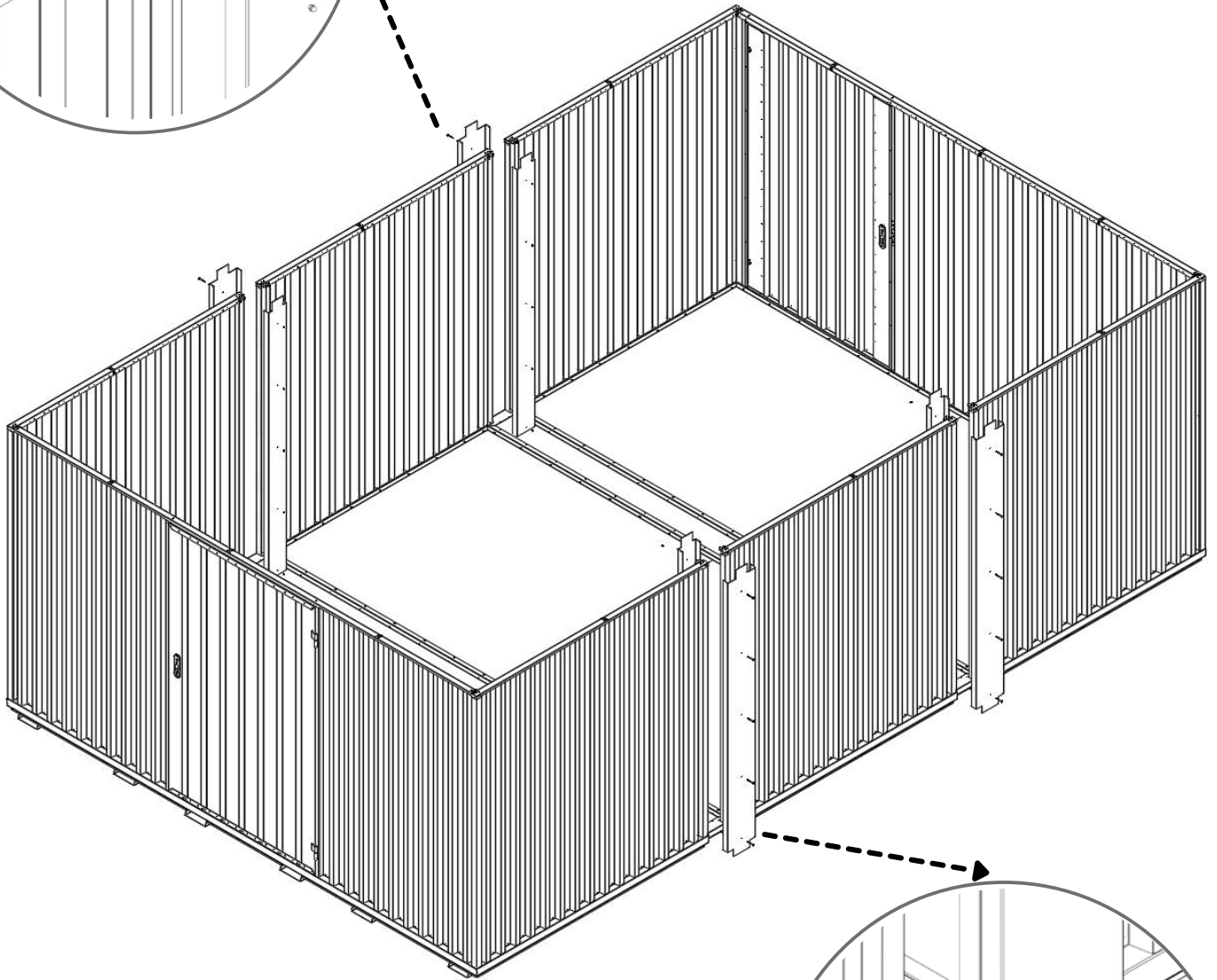
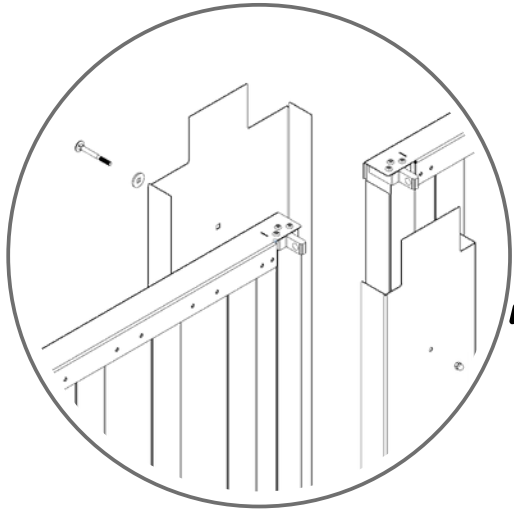

10

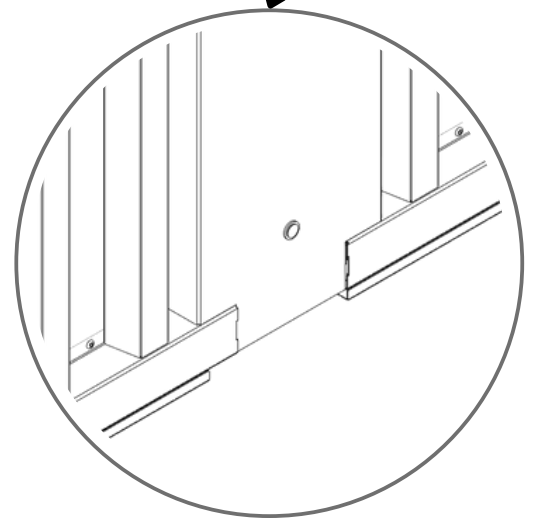
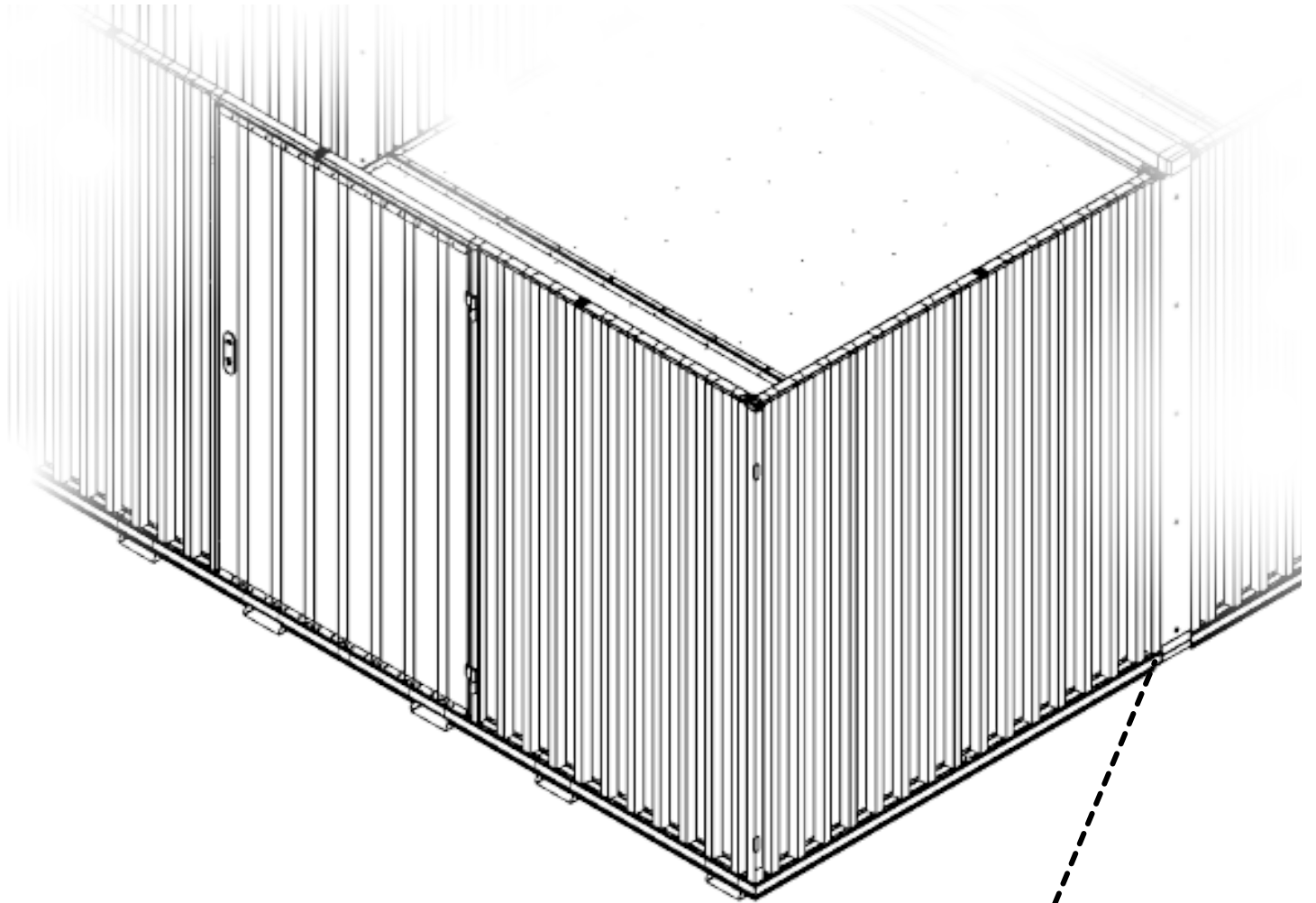



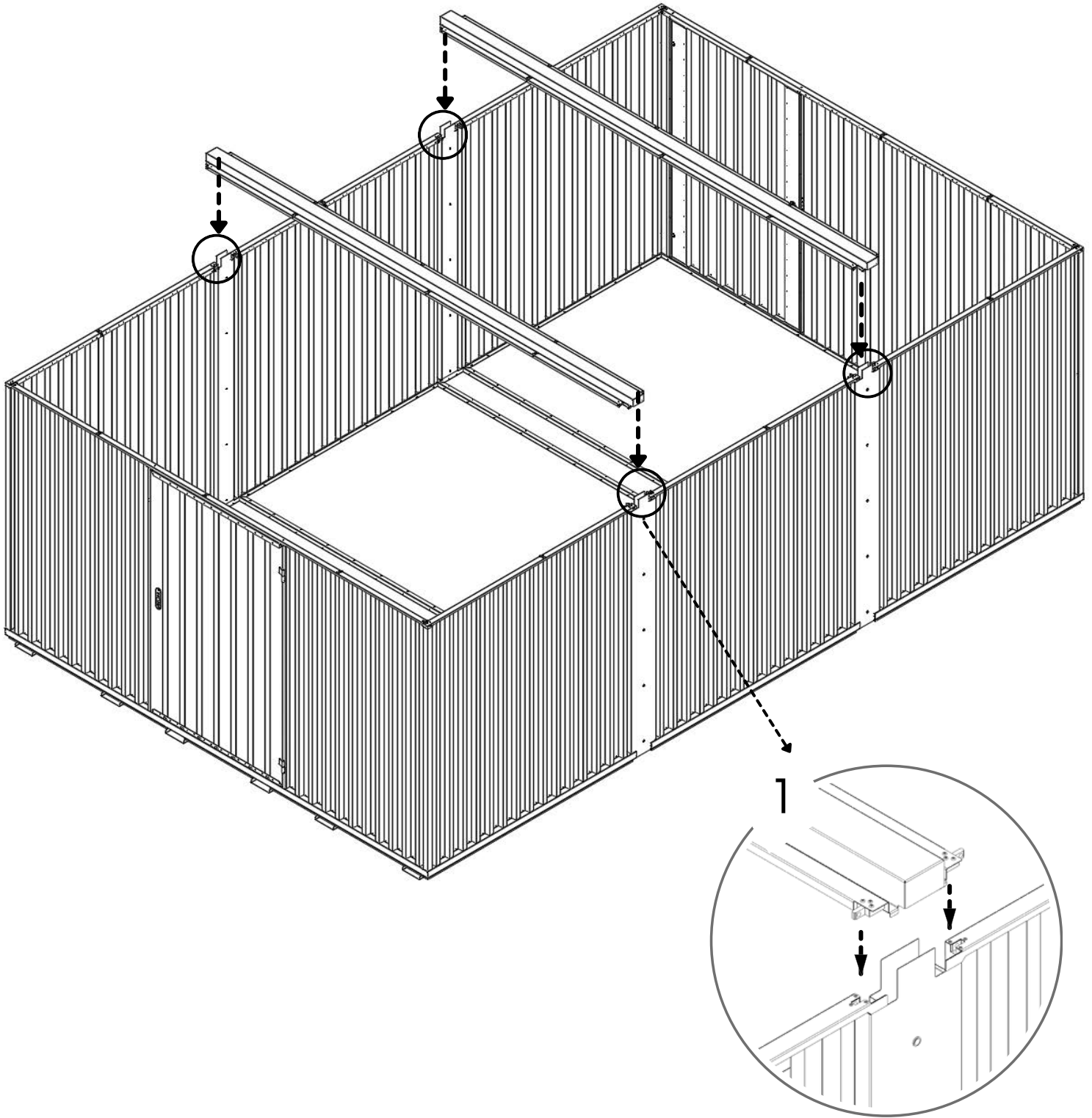



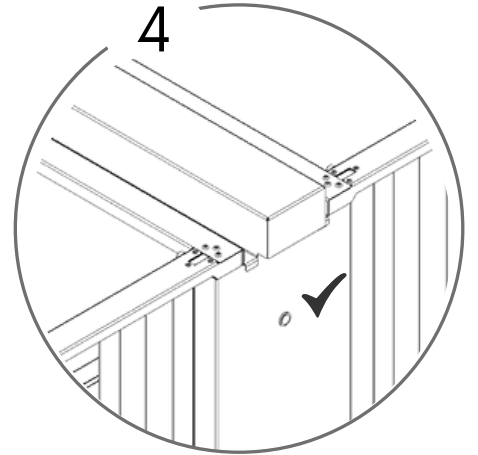
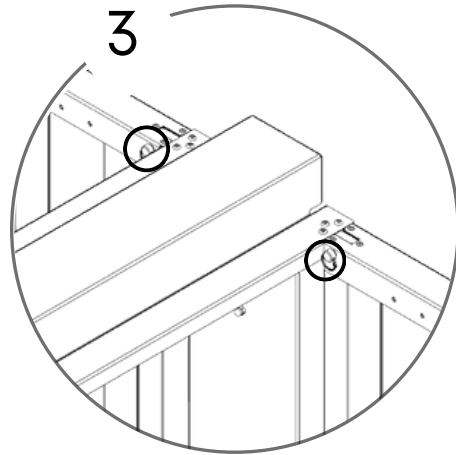
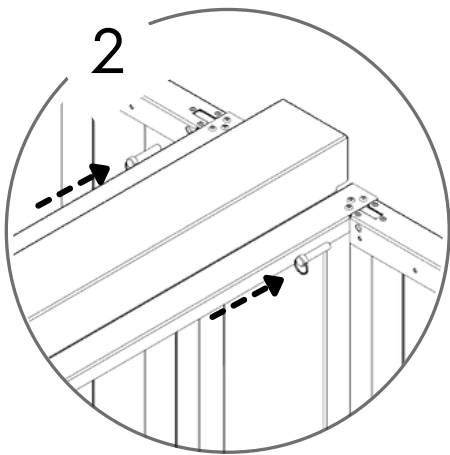
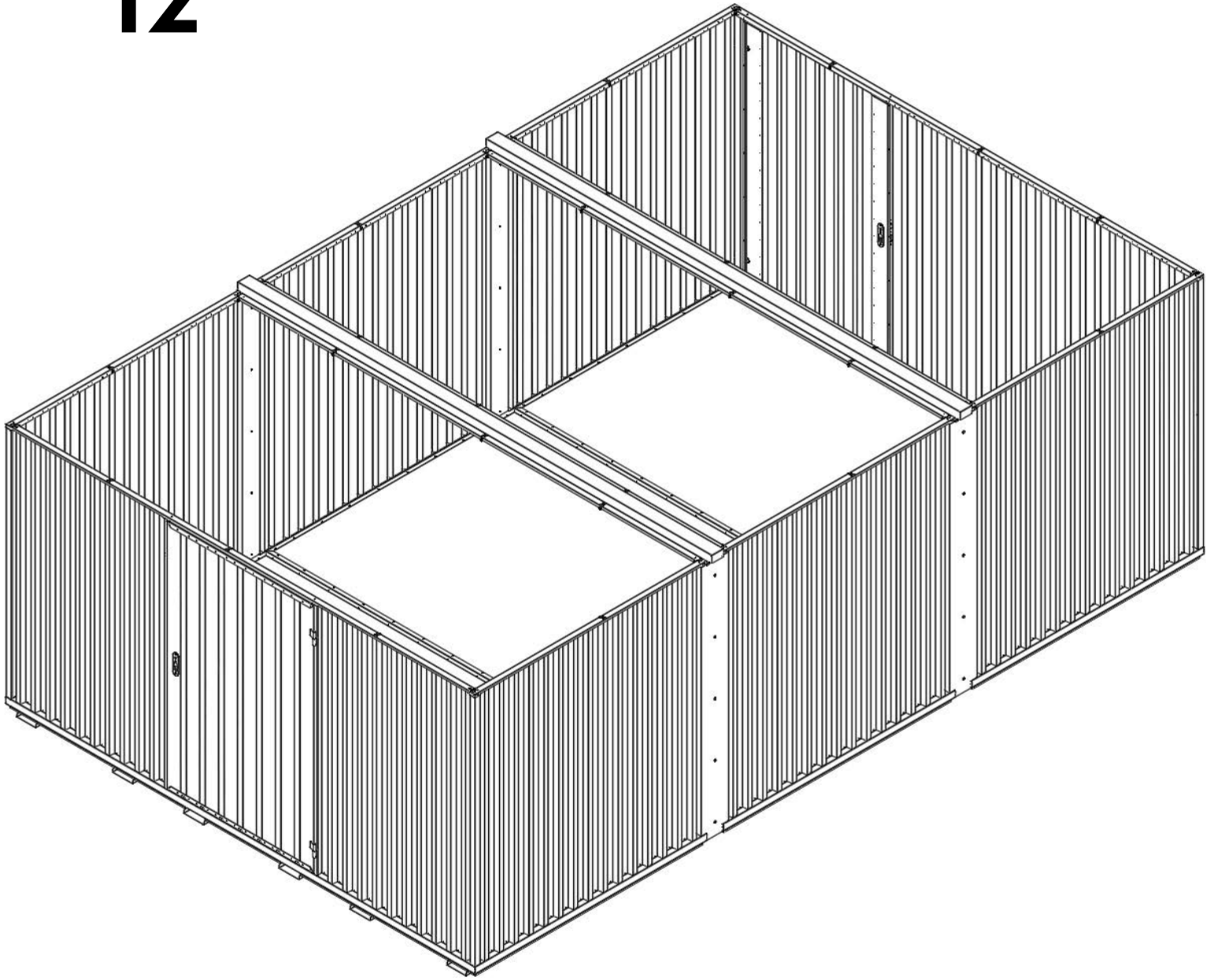

11



12





 1102 KG	 1640 MM	Model Code: 4044.110.420.440 Production Tracking Code:/X09.1.4044.420.440	 9001	 14001	 50001			
--	--	---	---	--	--	---	---	---

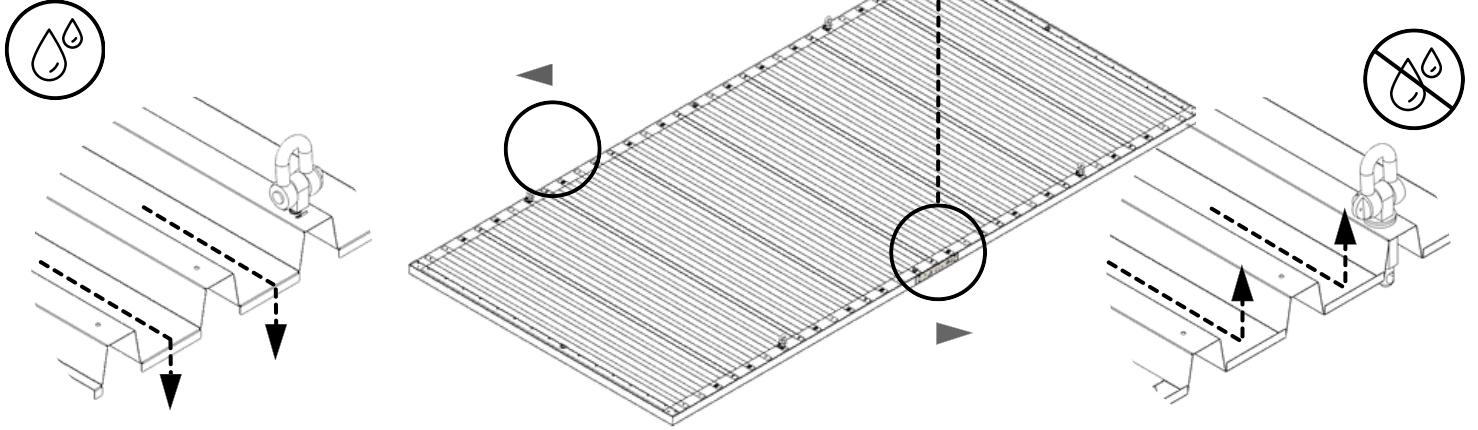

13

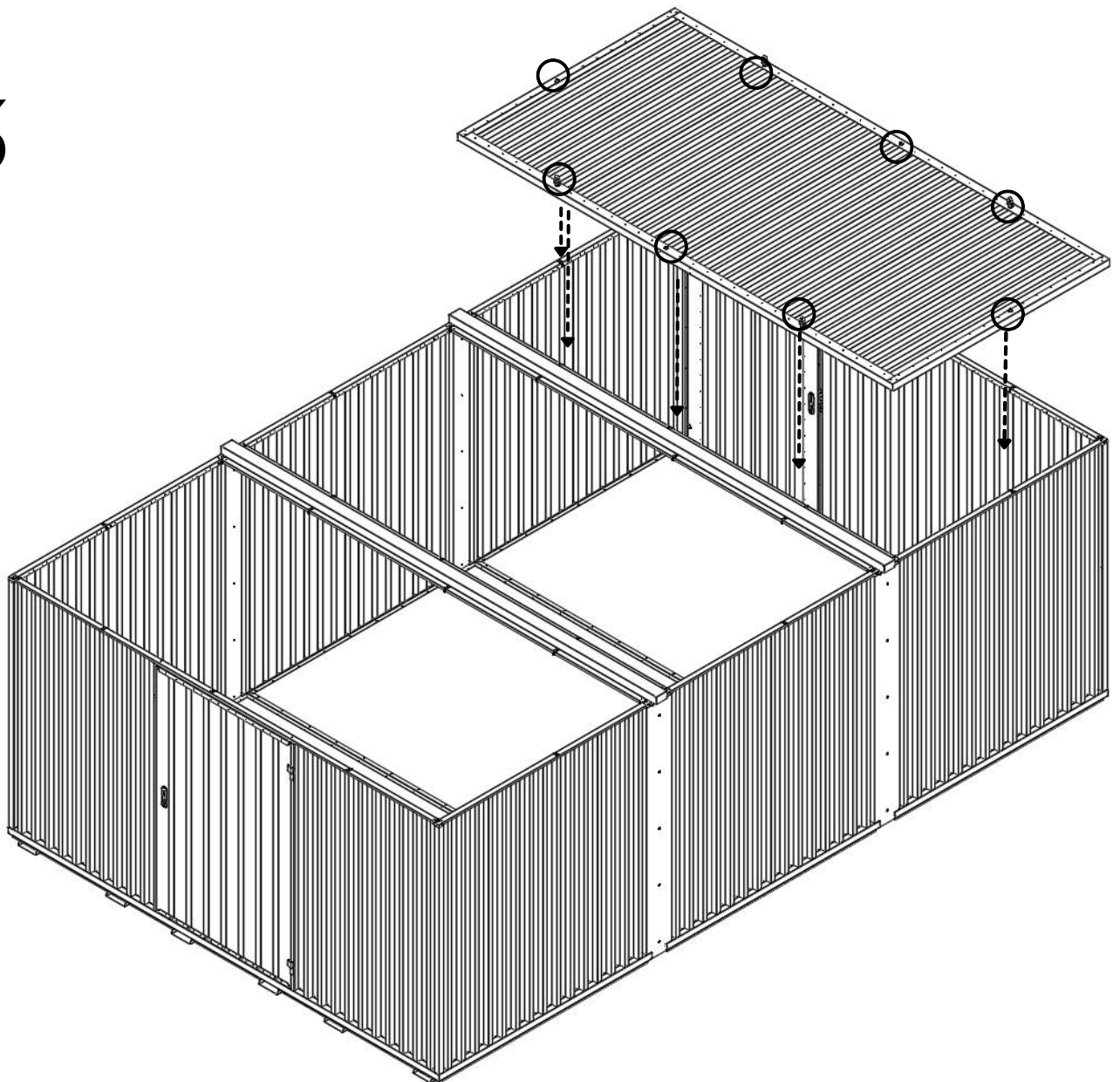

14

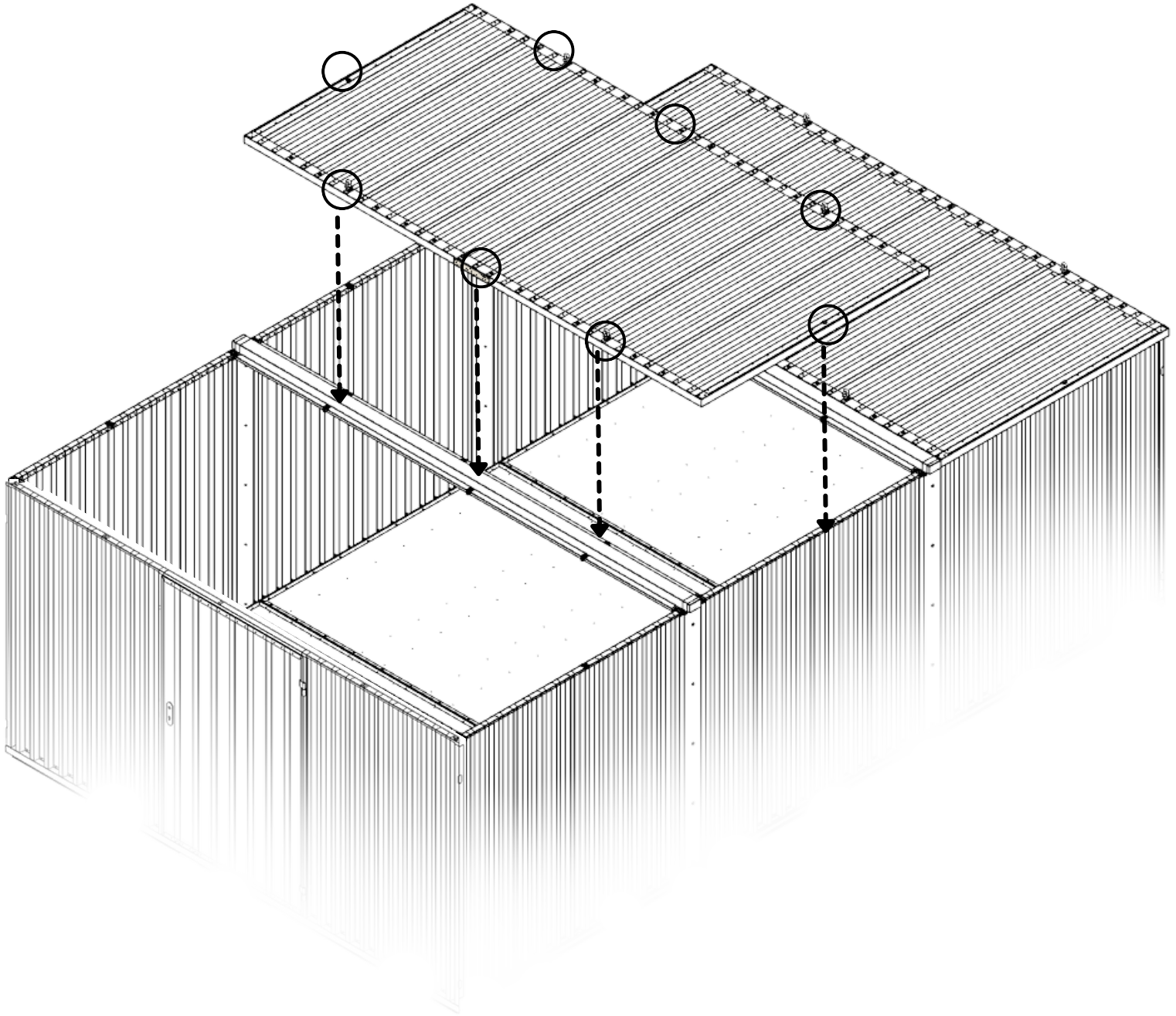

15

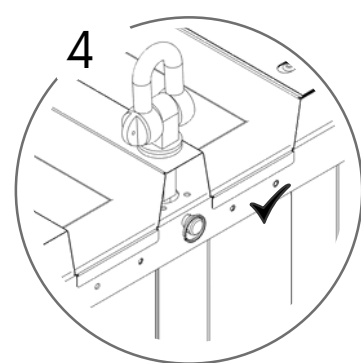
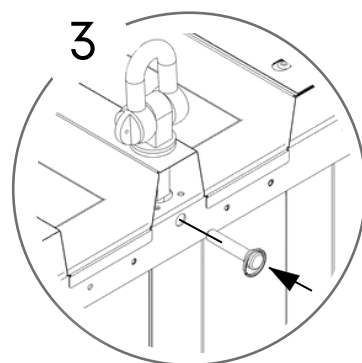
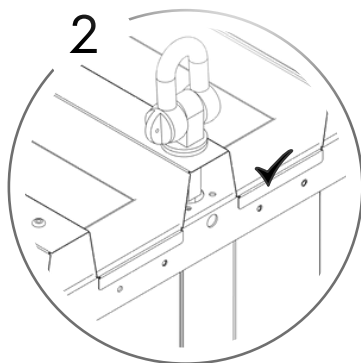
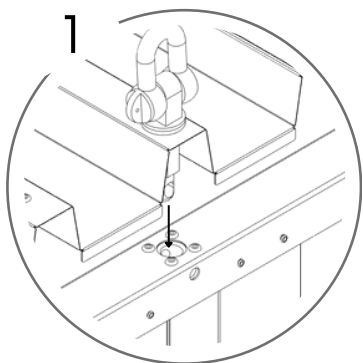
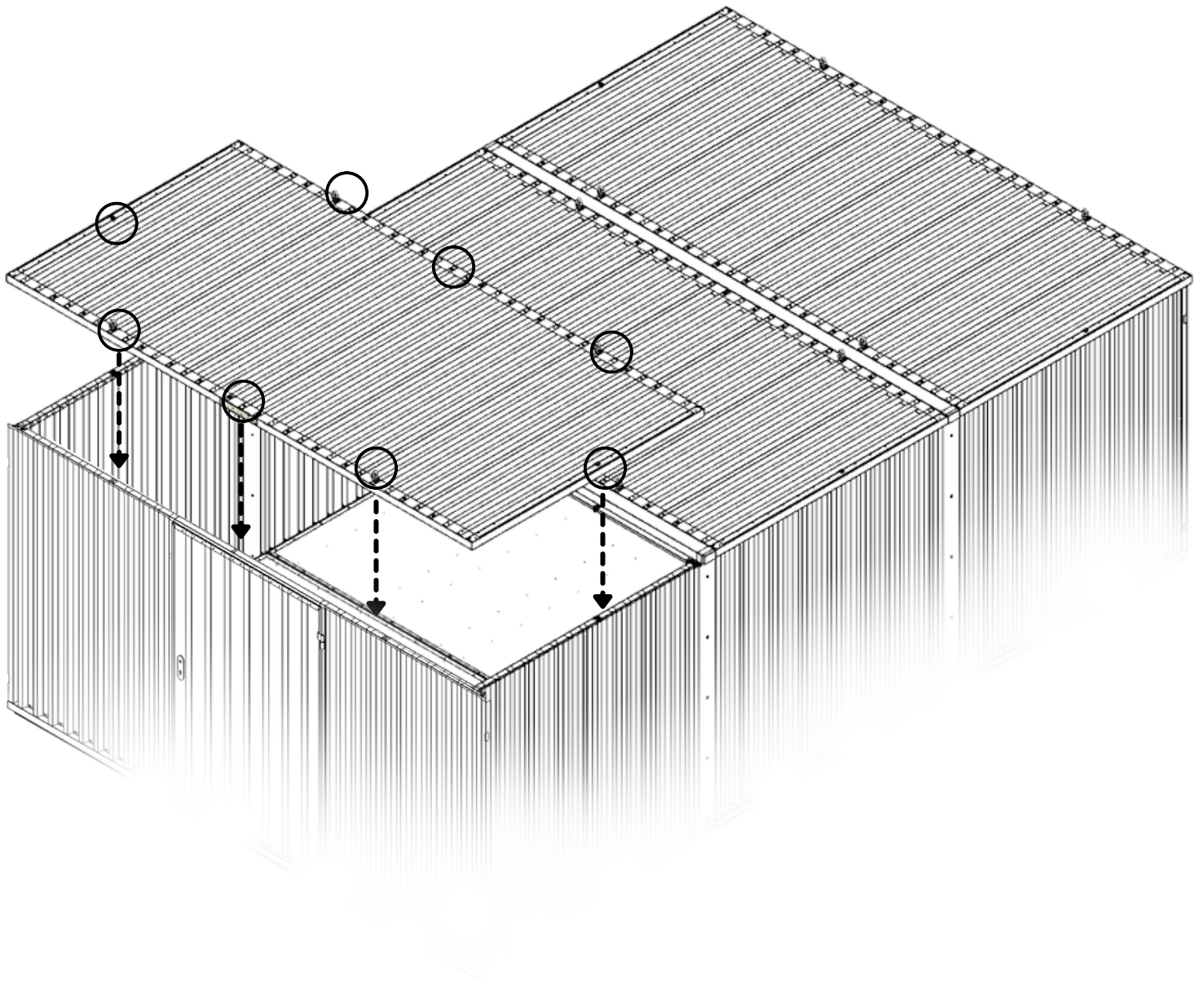

16

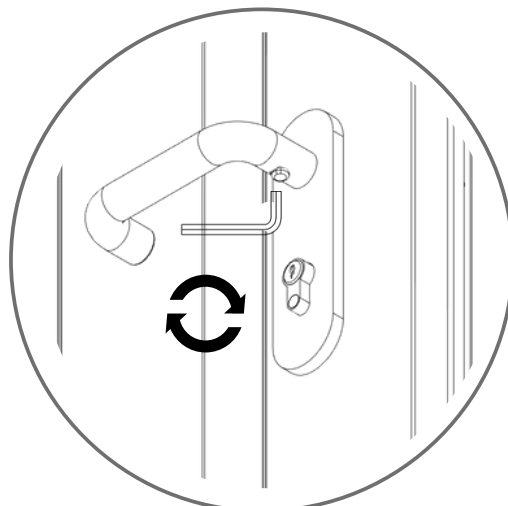
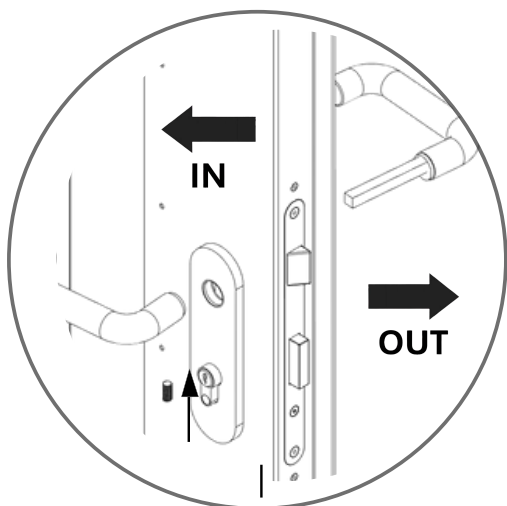
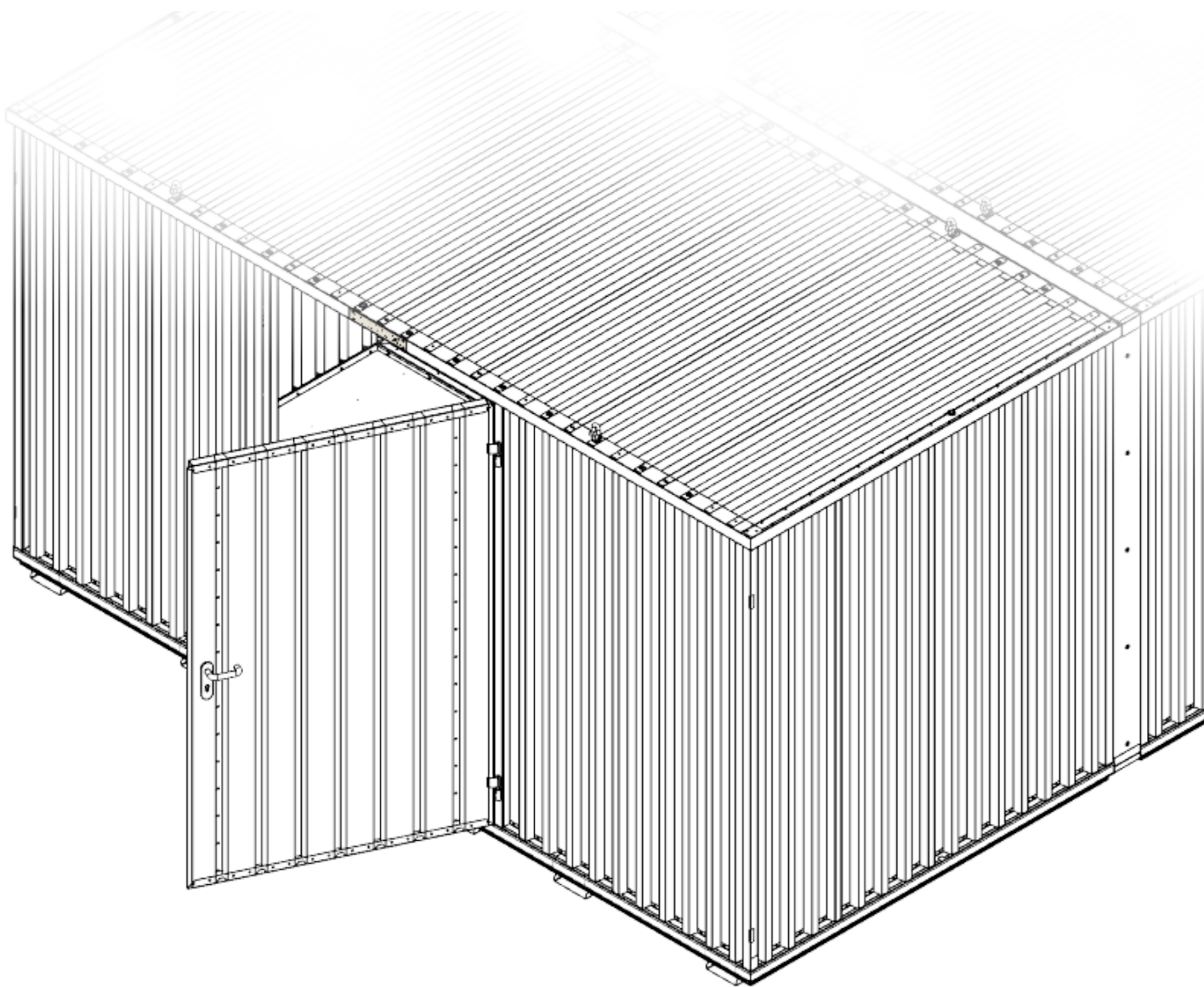

17

