

PRODUCT CODE:303.110.430

prefabase
Quick Build Solutions

Instructions and User Guide

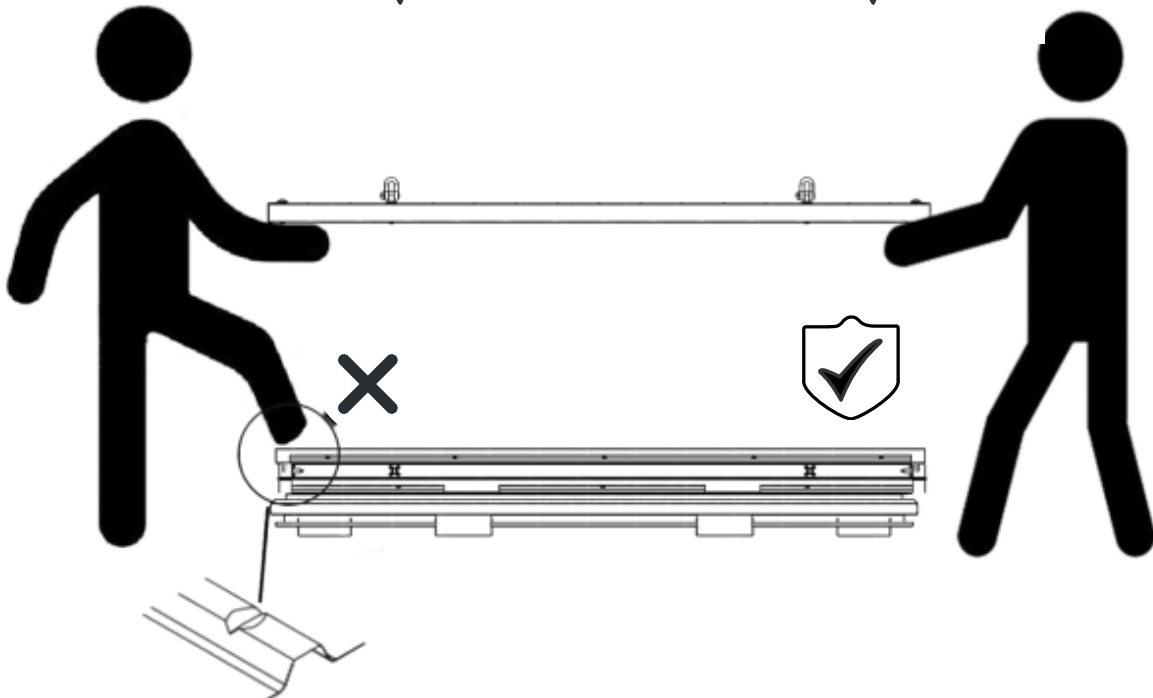
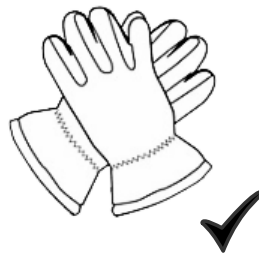

30.0110

2x

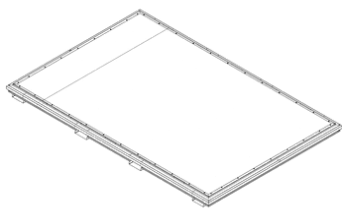

30.0510

2x

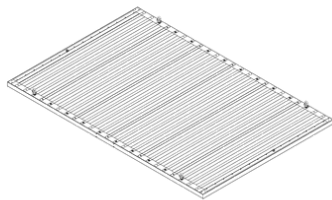

303.0110

1x



303.0510

1x



30.0410

1x

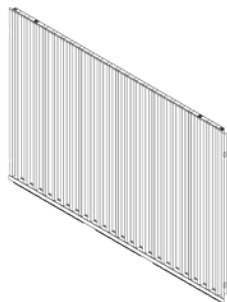

30.0430

1x

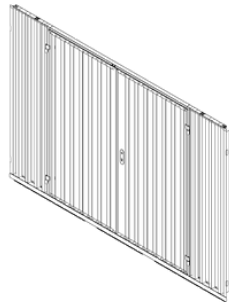

0310

4x

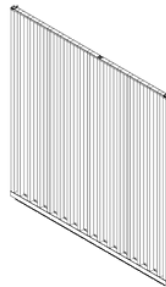

305.20.08

2x



305.20.09

2x



61.101

4x



20x

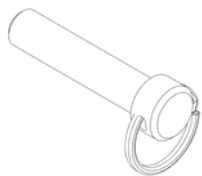

1x

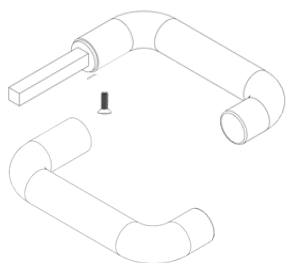

10x



10x



10x



1x



1x



1

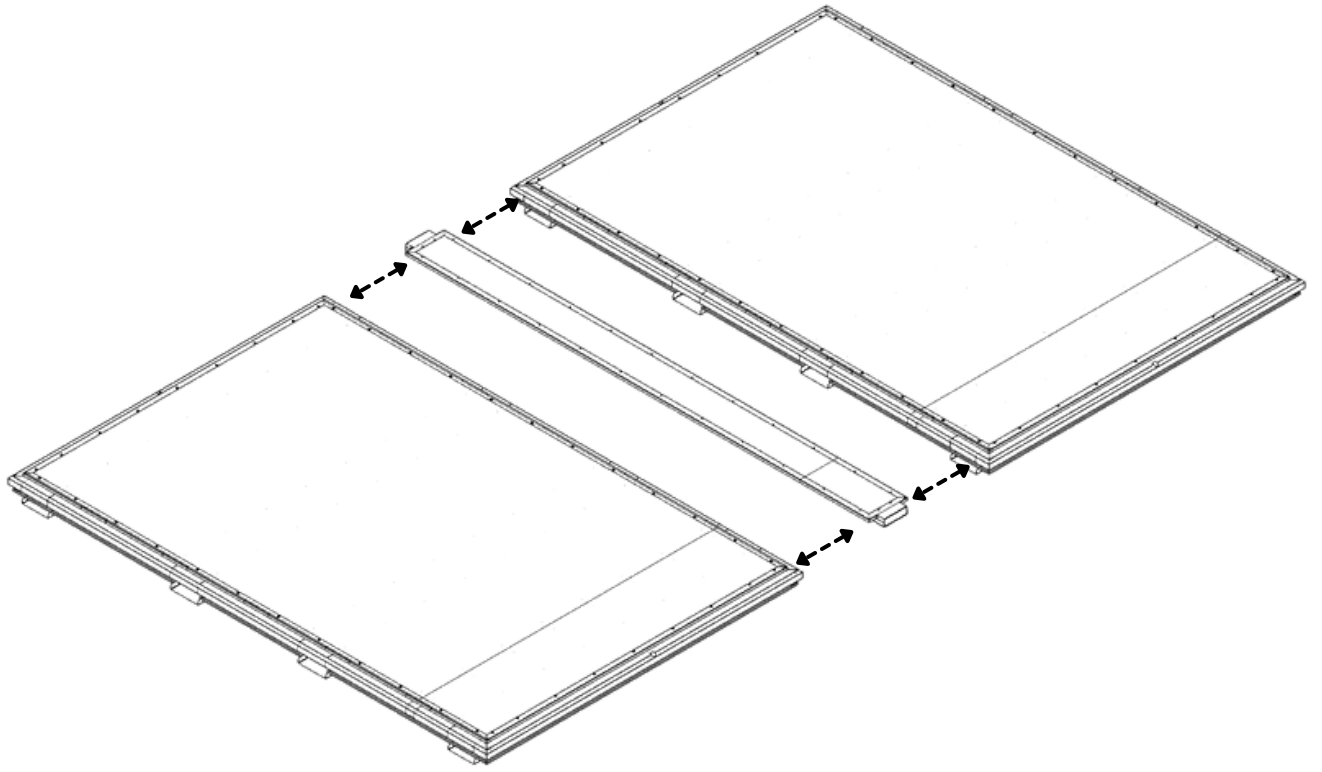

2

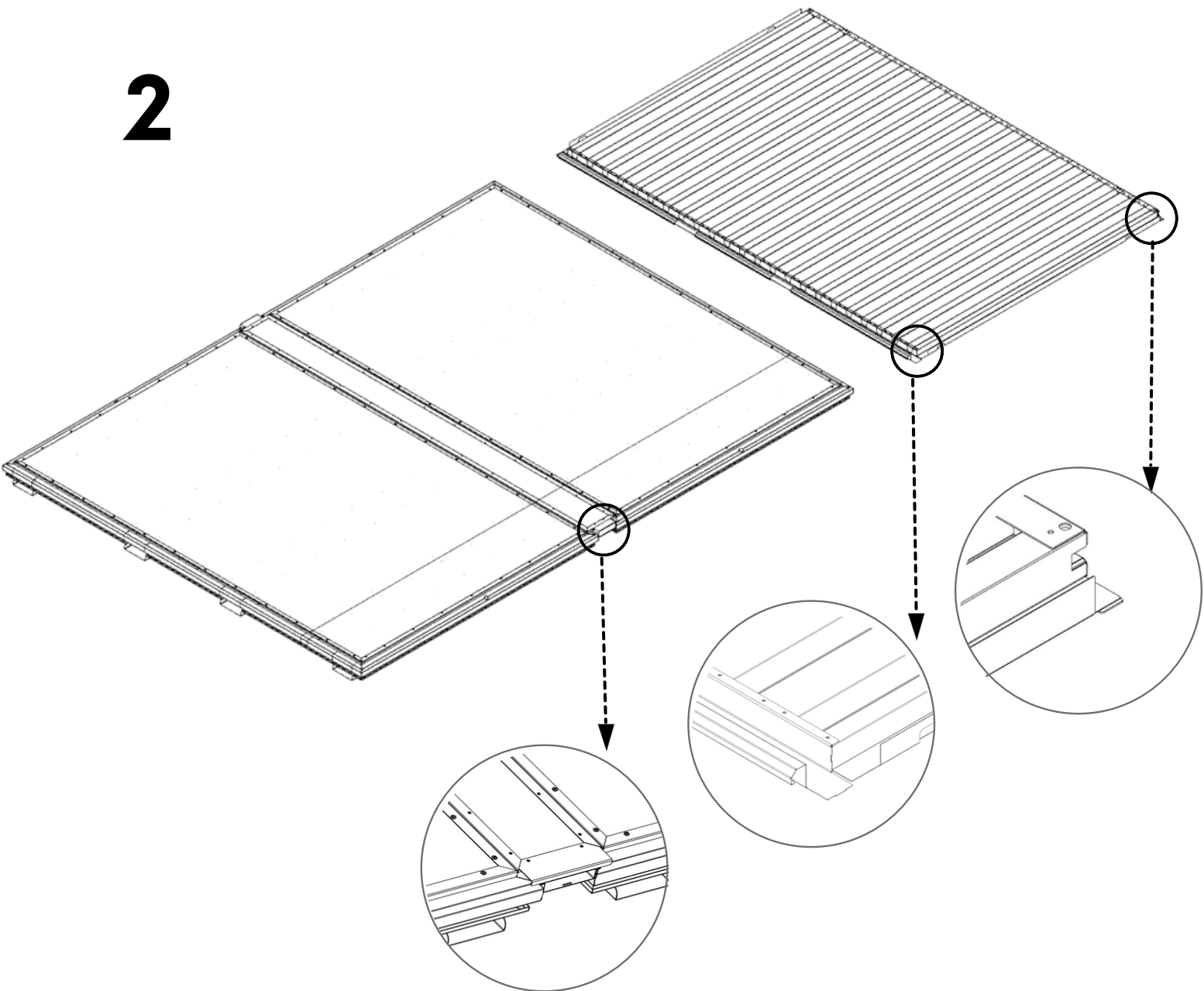

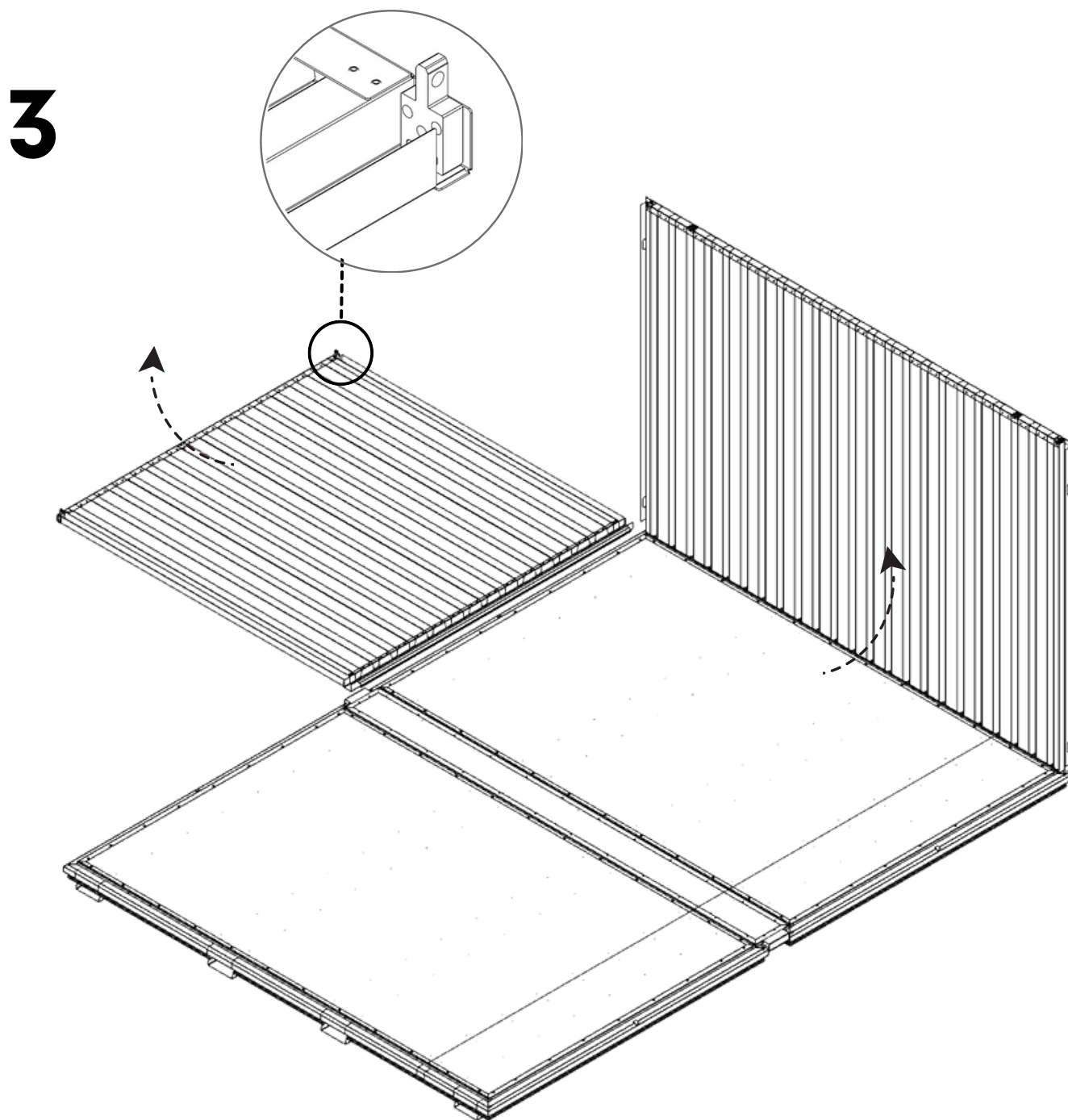
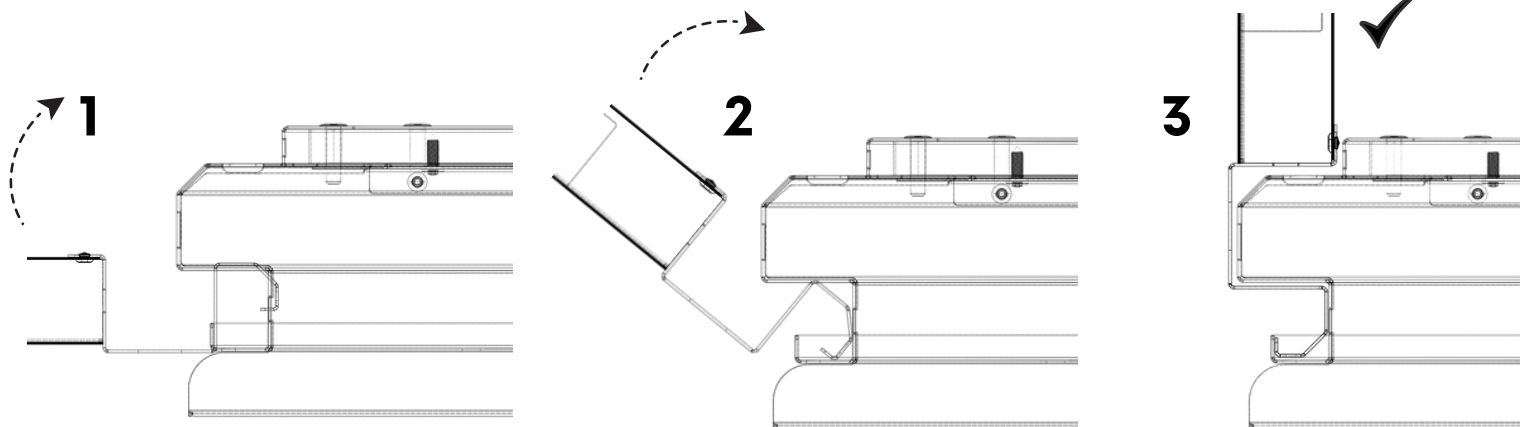

4

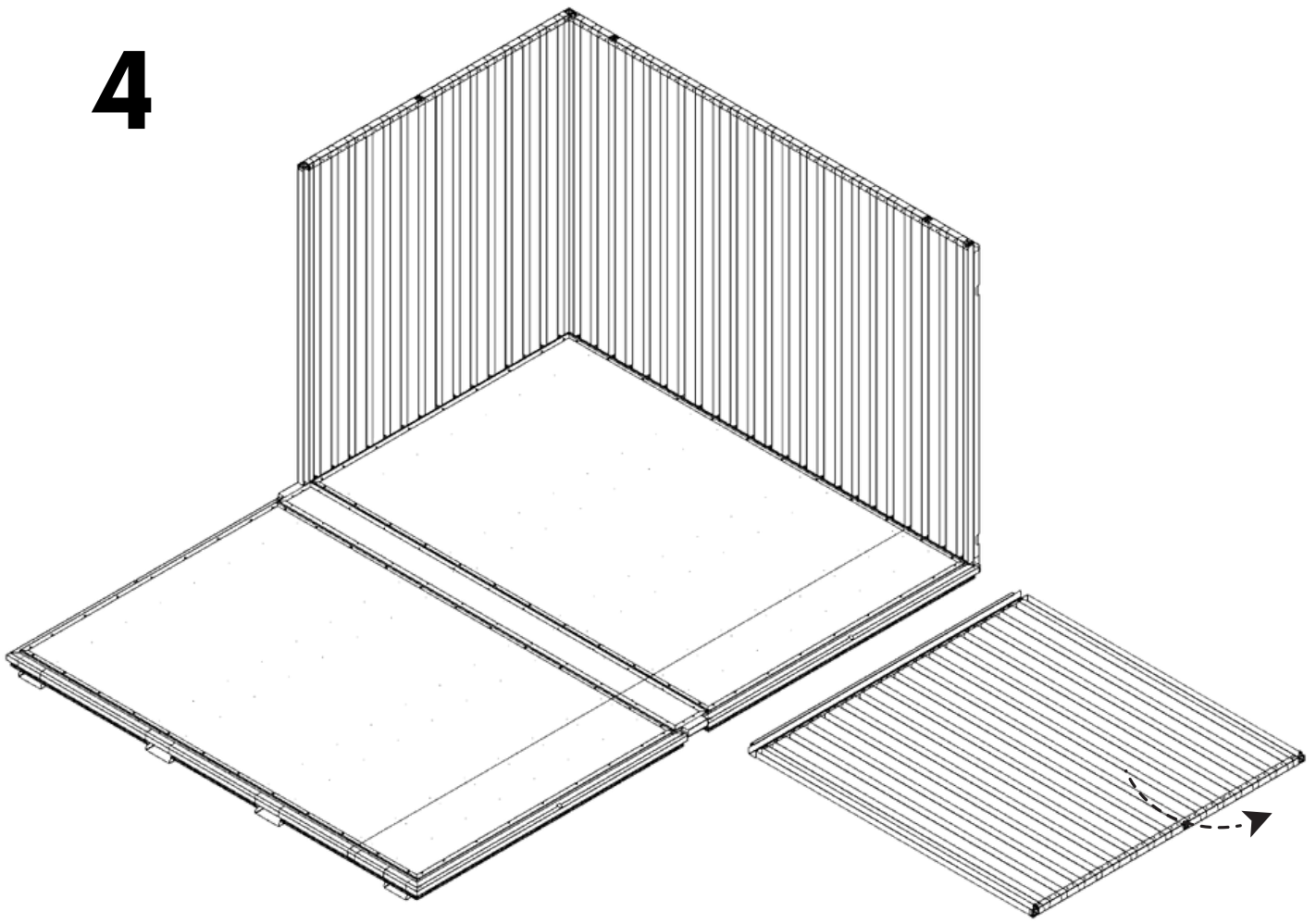

4.1

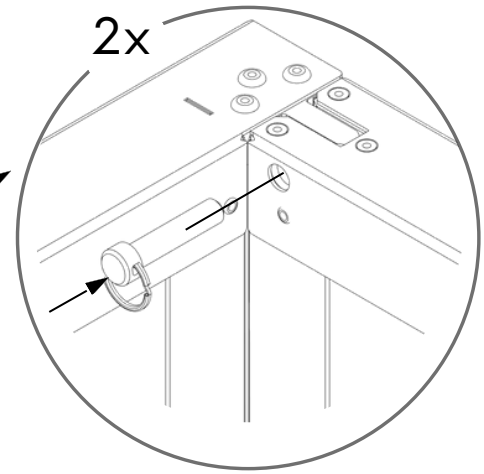
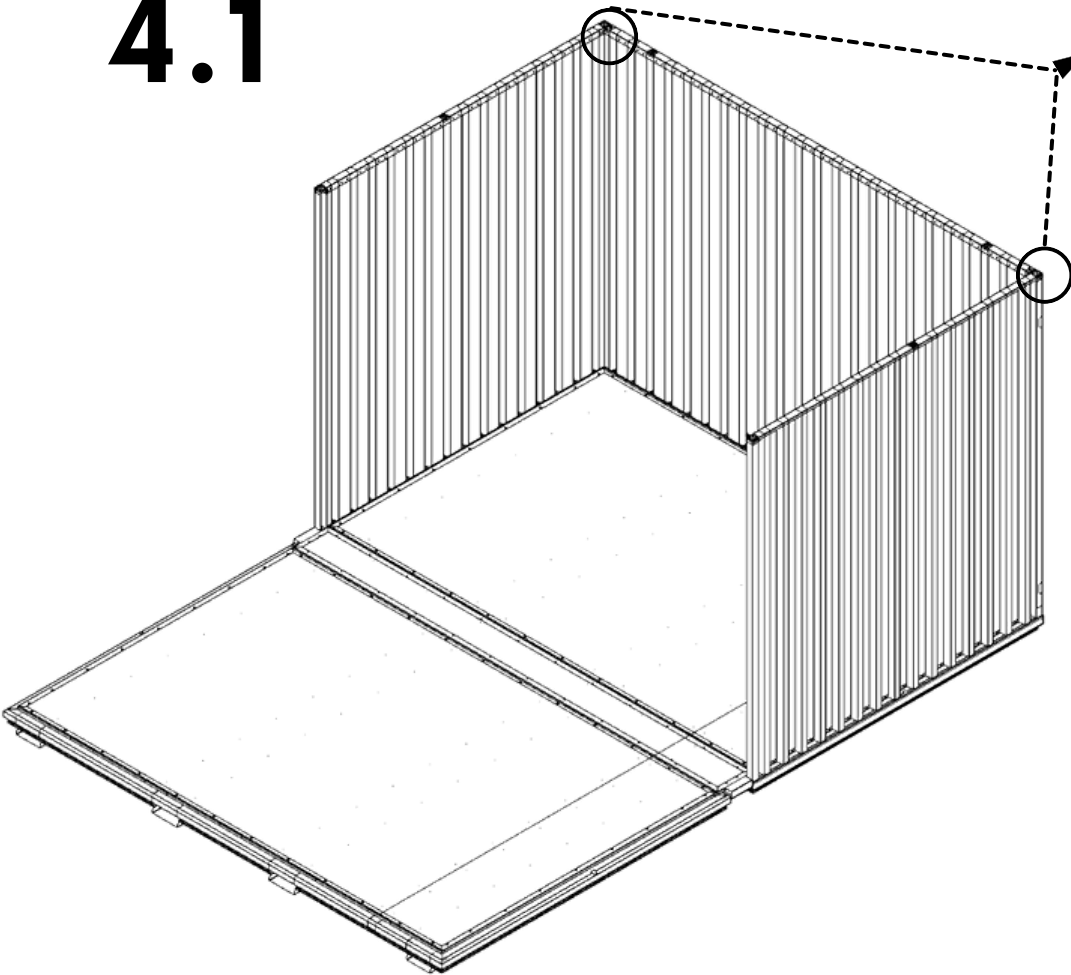

5

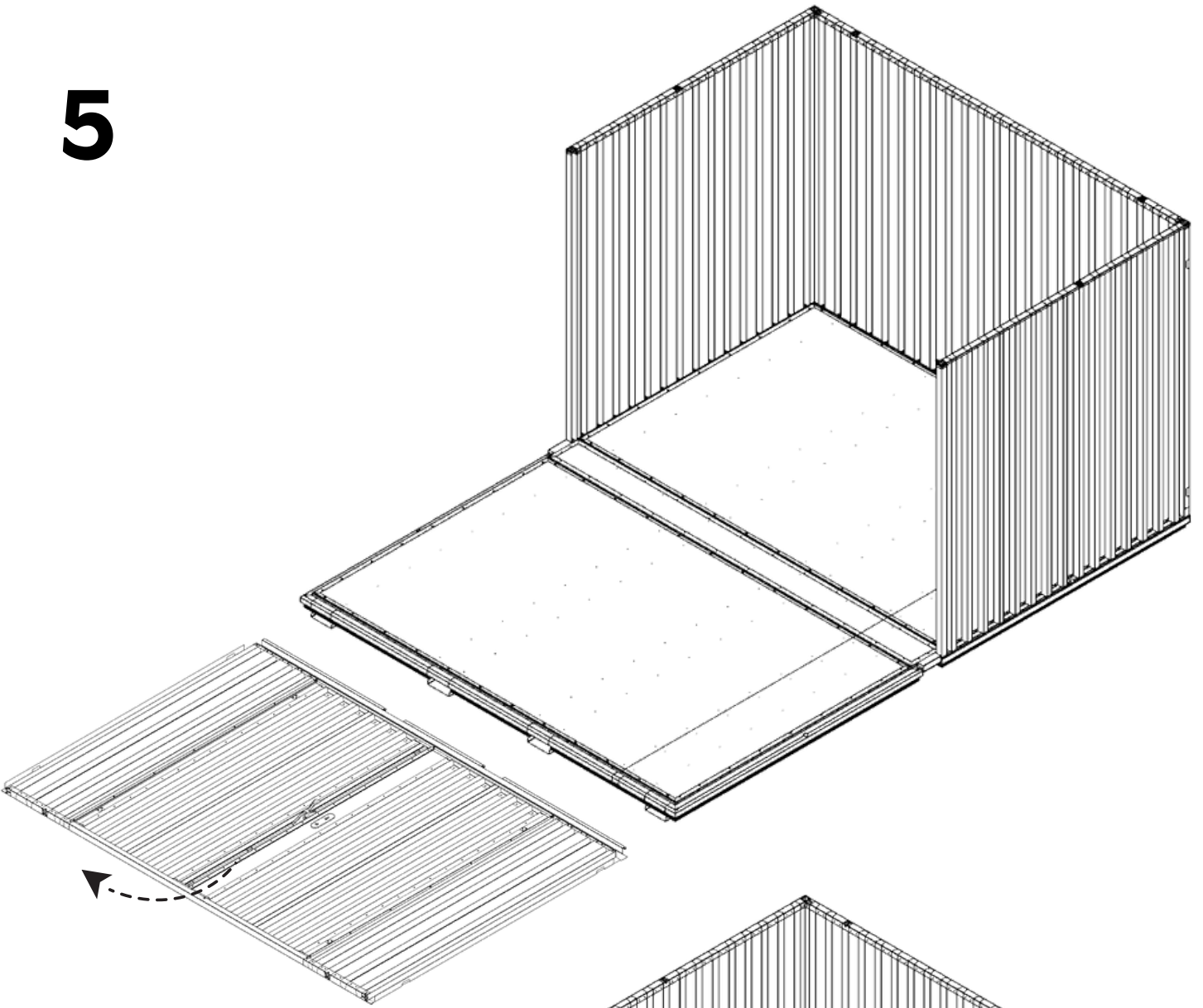

6

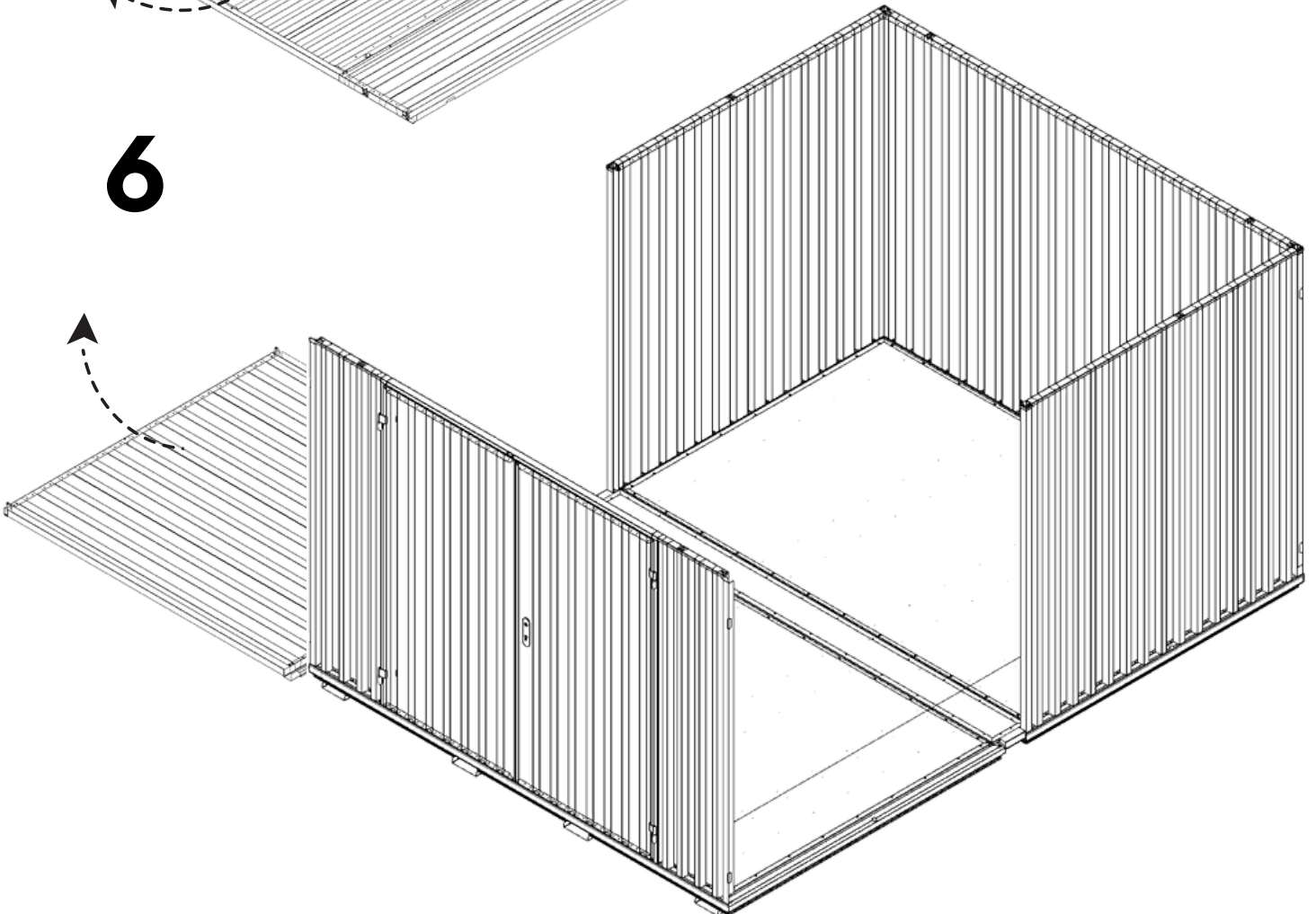

7

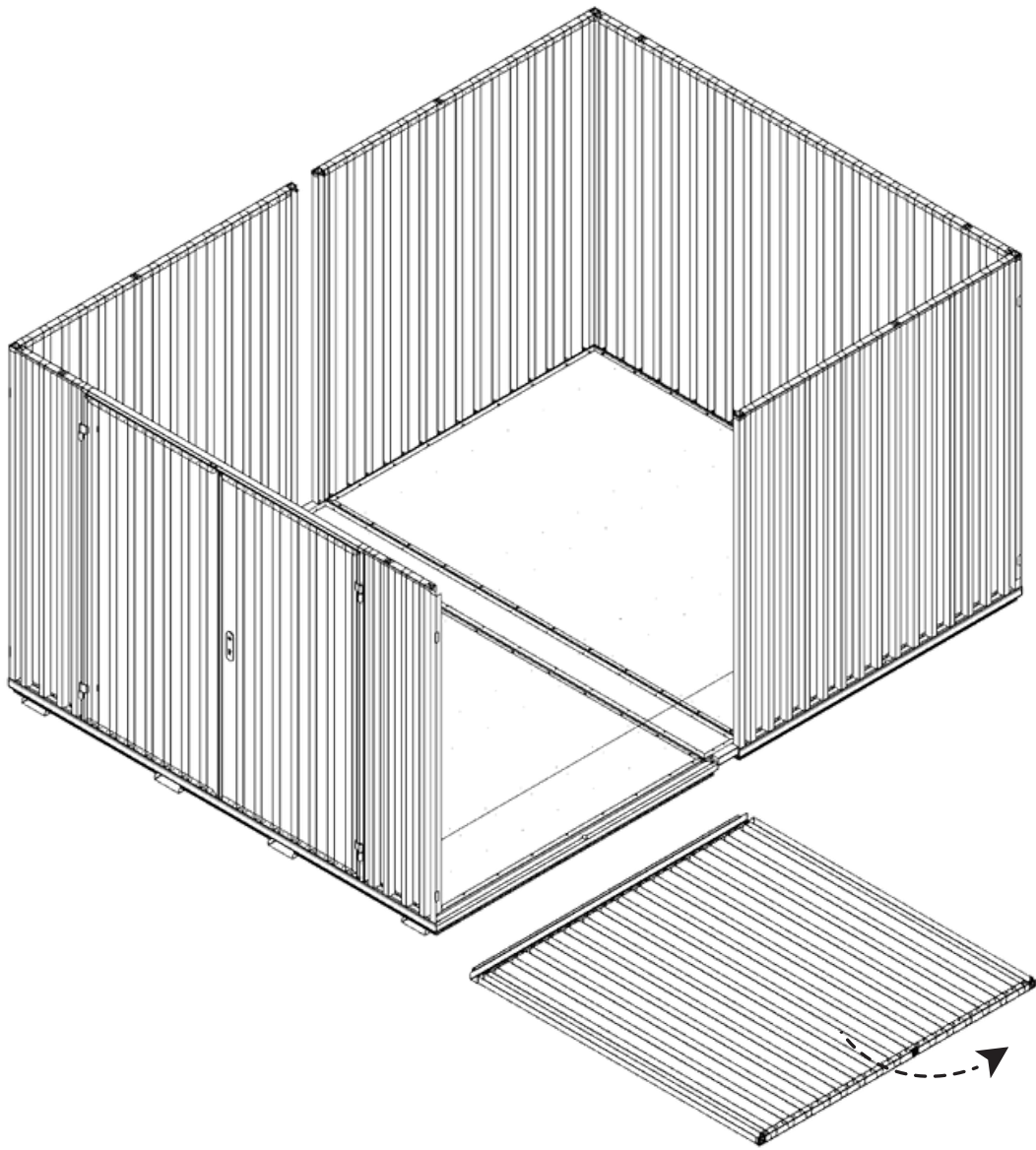

7.1

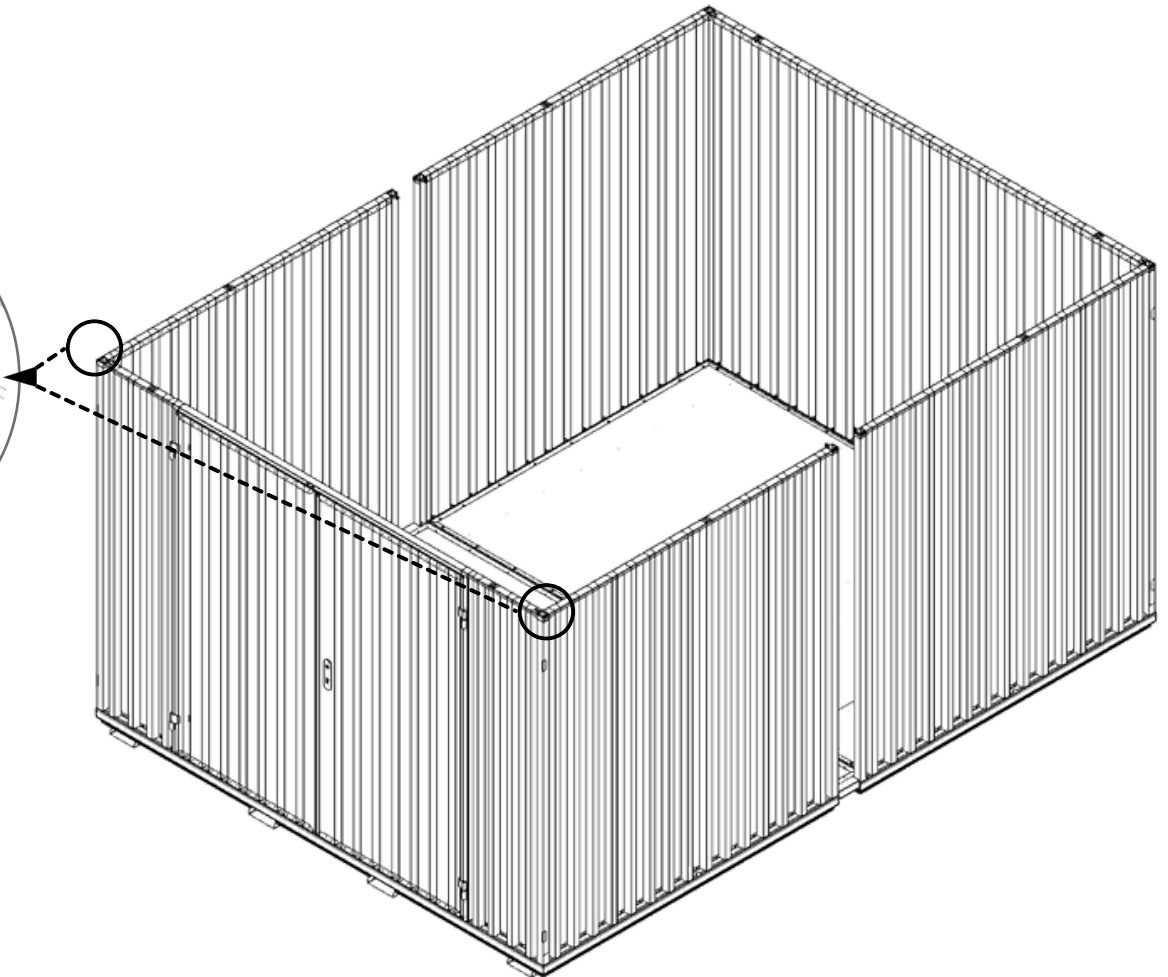
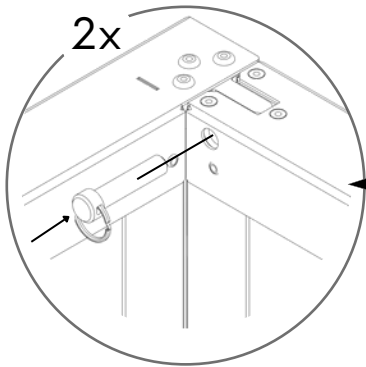

8

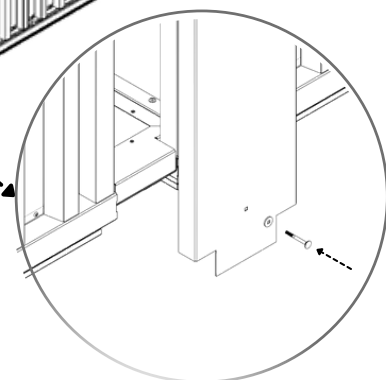
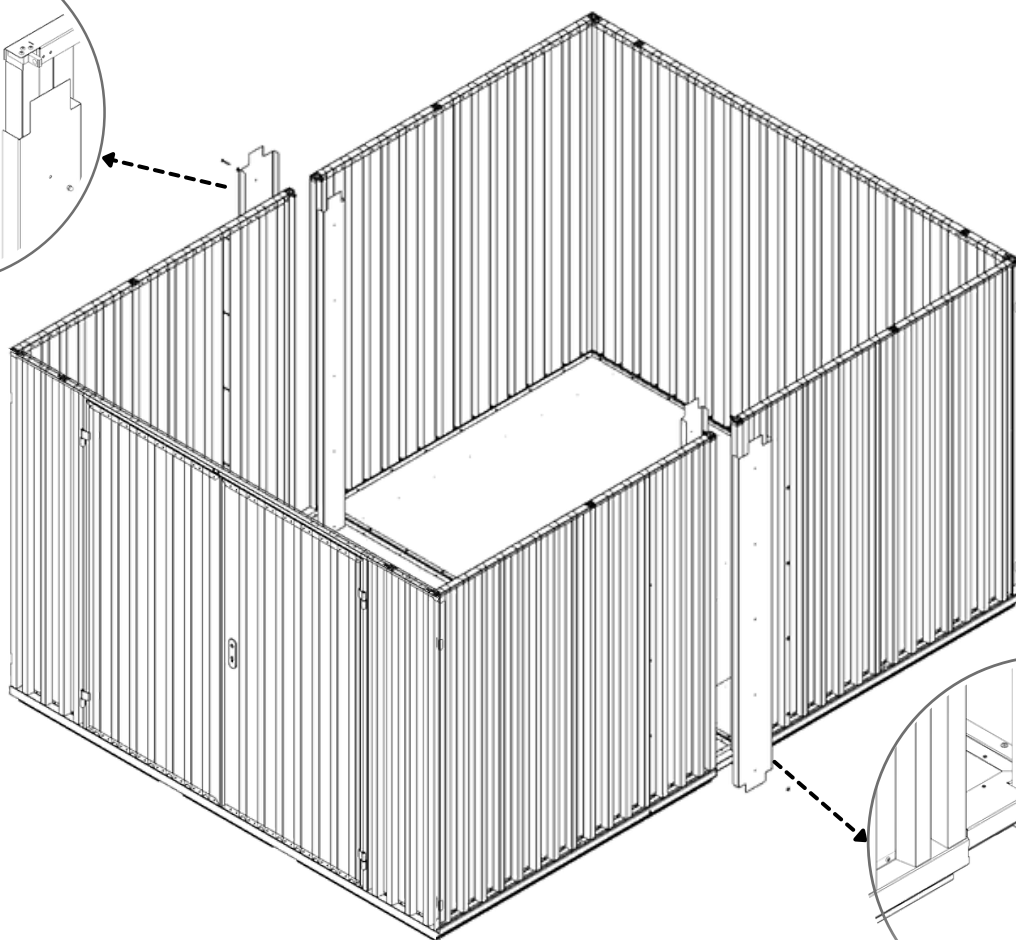
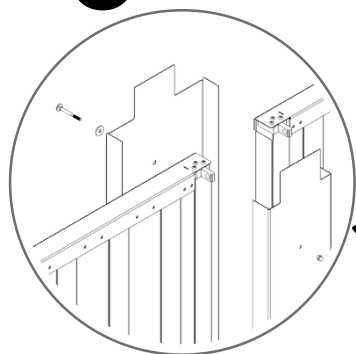

8.1

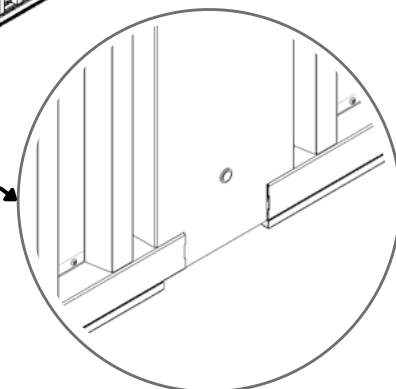
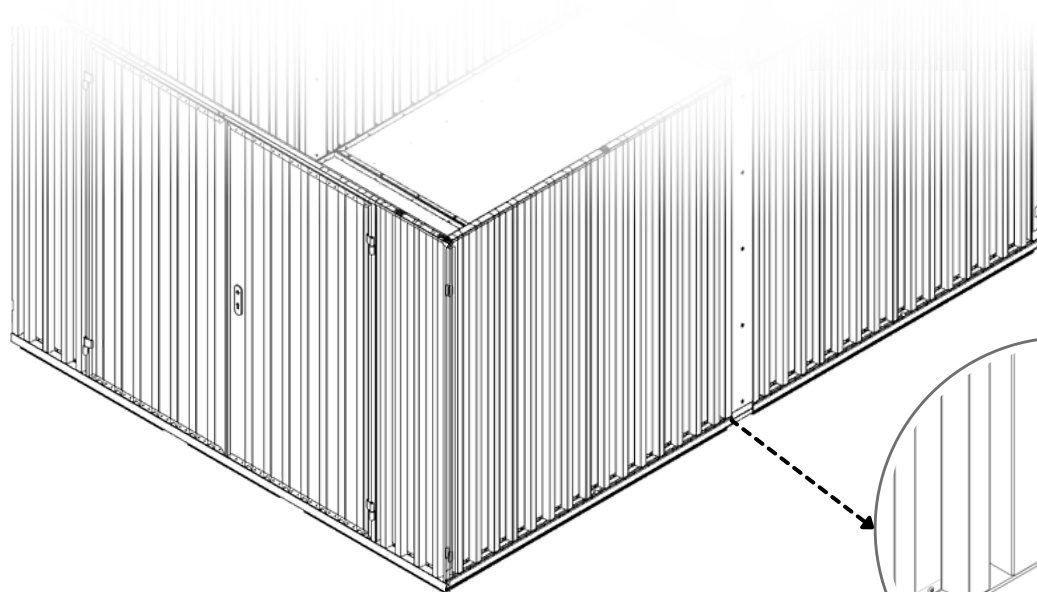



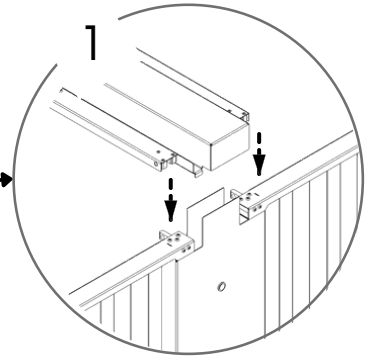
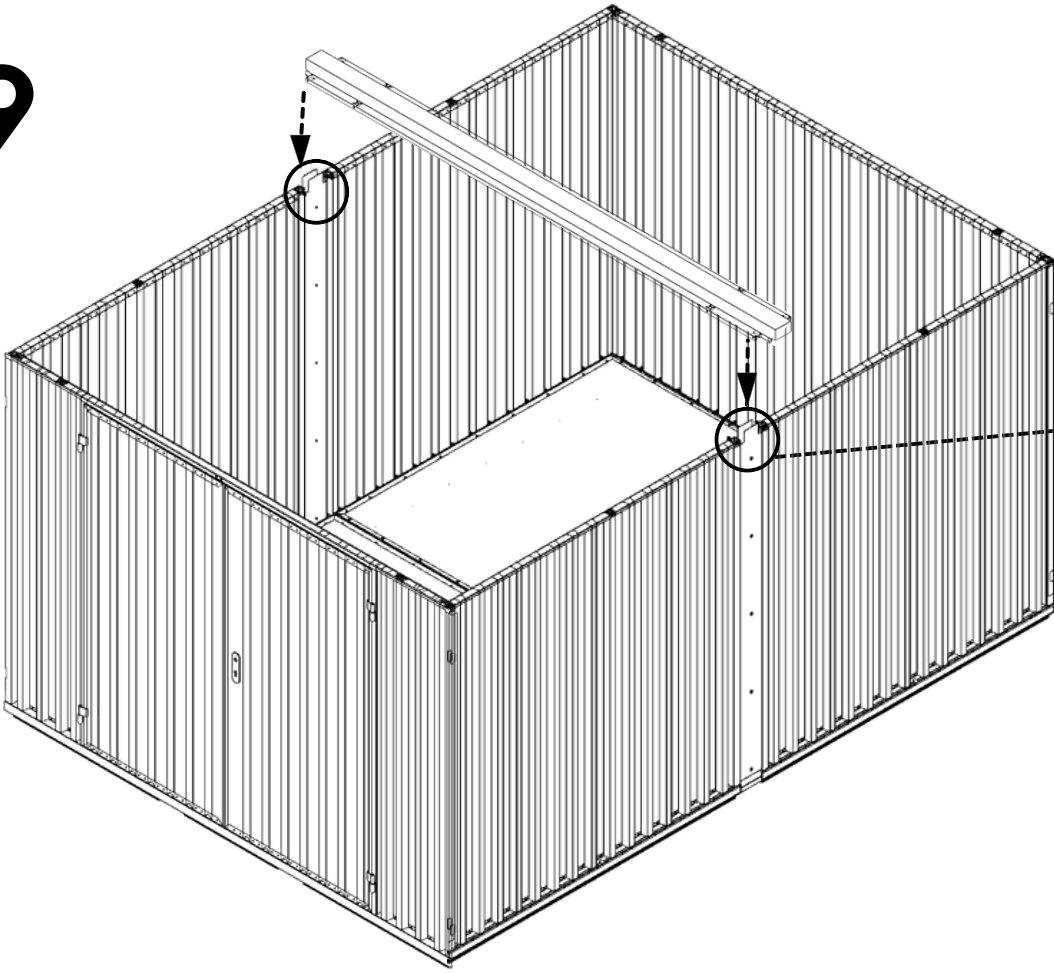



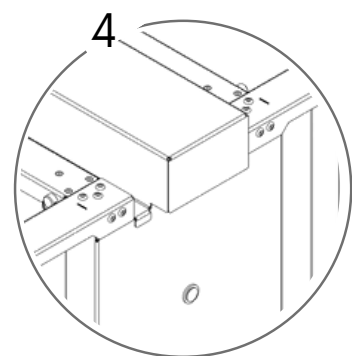
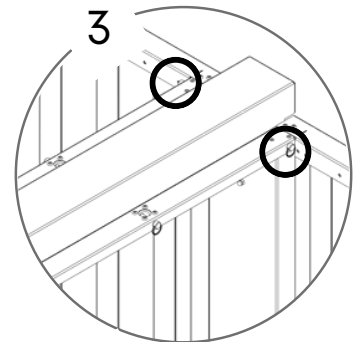
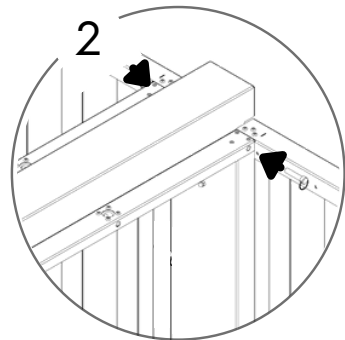
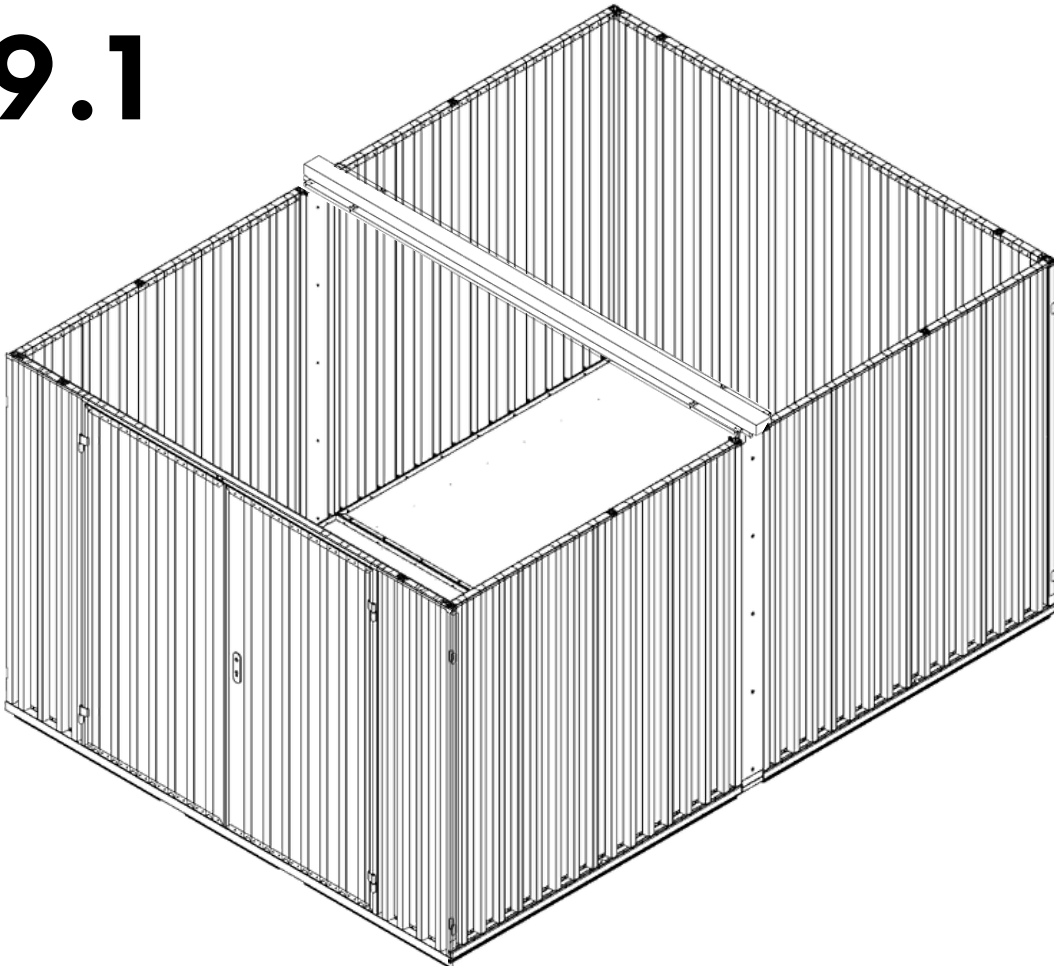

9



9.1





 617 KG	 1640 MM	Model Code: 303.110.430 Production Tracking Code:/X09.1.303.430	 9001	 14001	 50001			
---	--	---	---	--	---	---	---	---

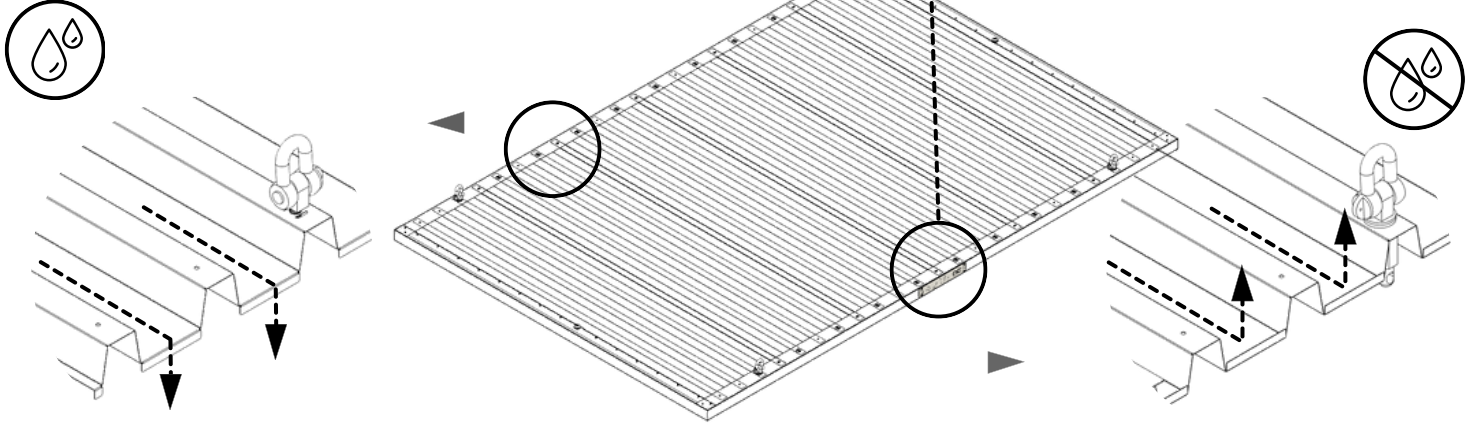

10

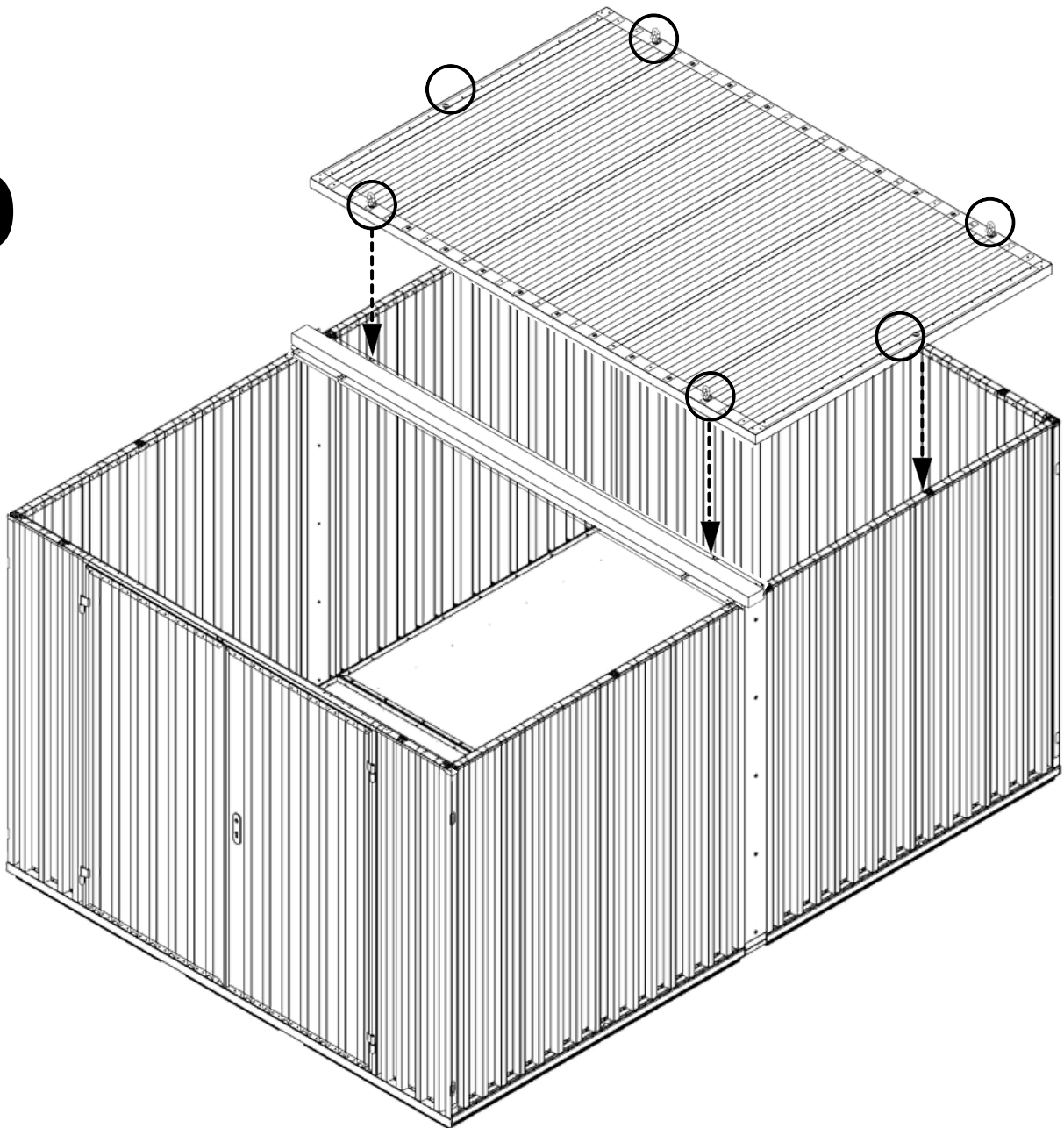

11

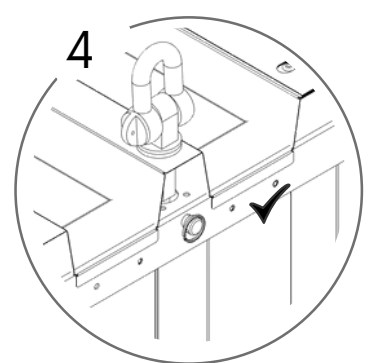
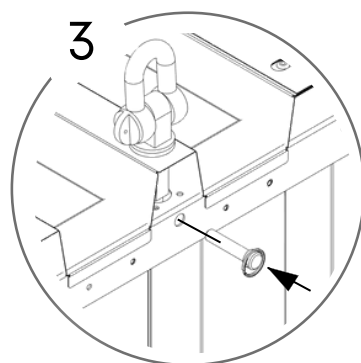
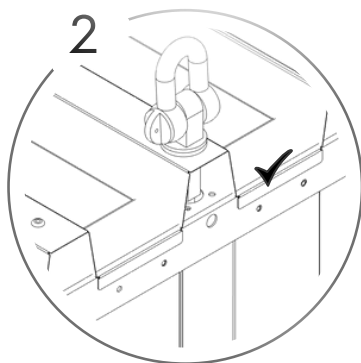
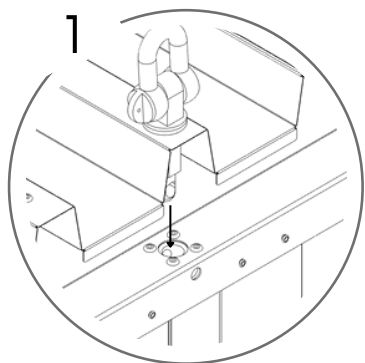
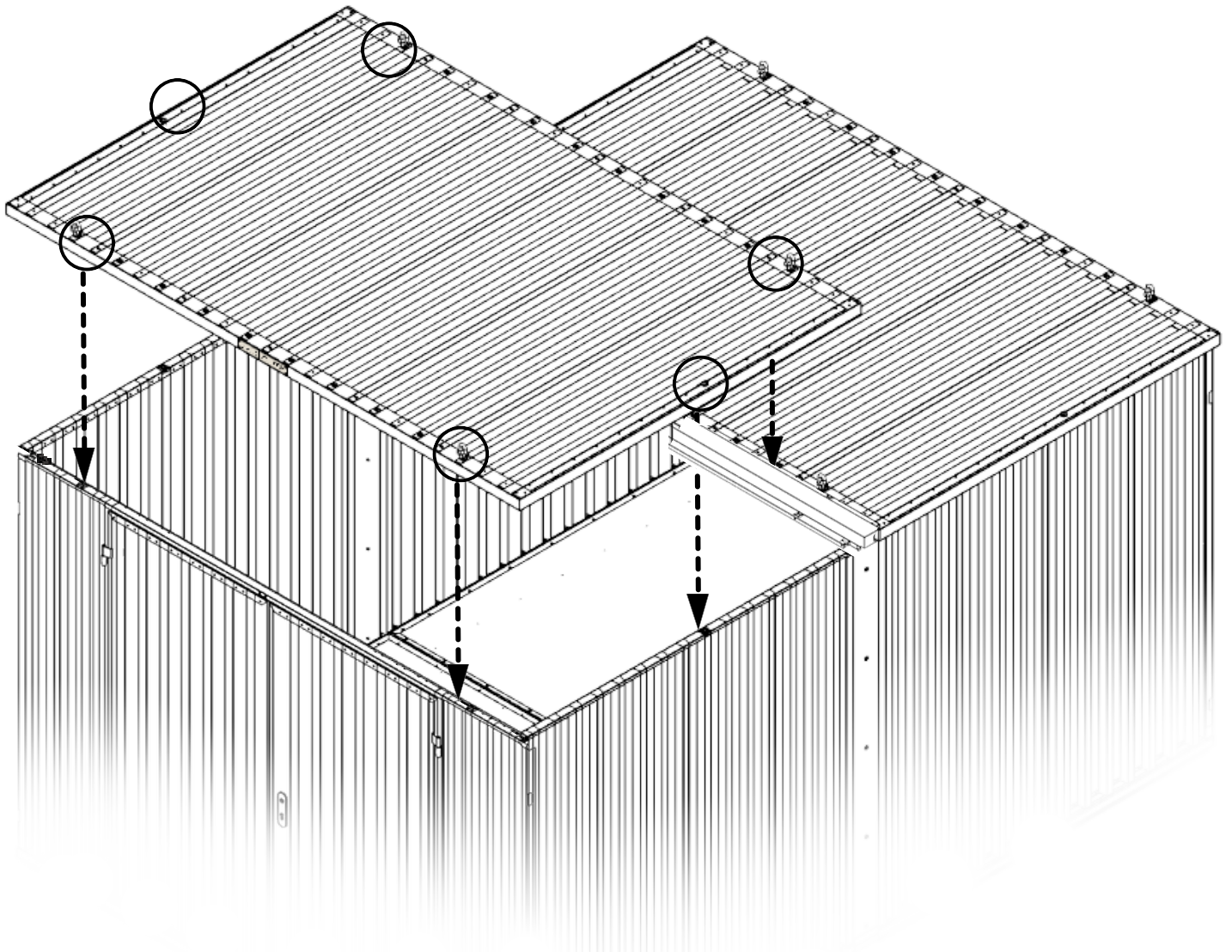

12

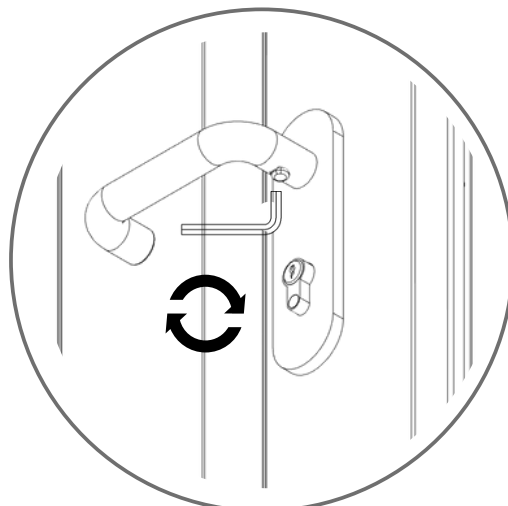
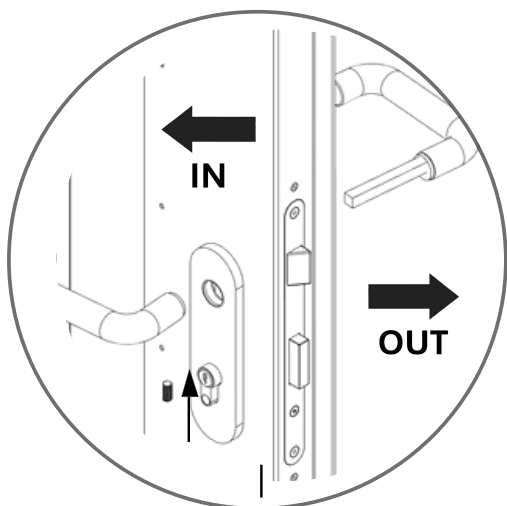
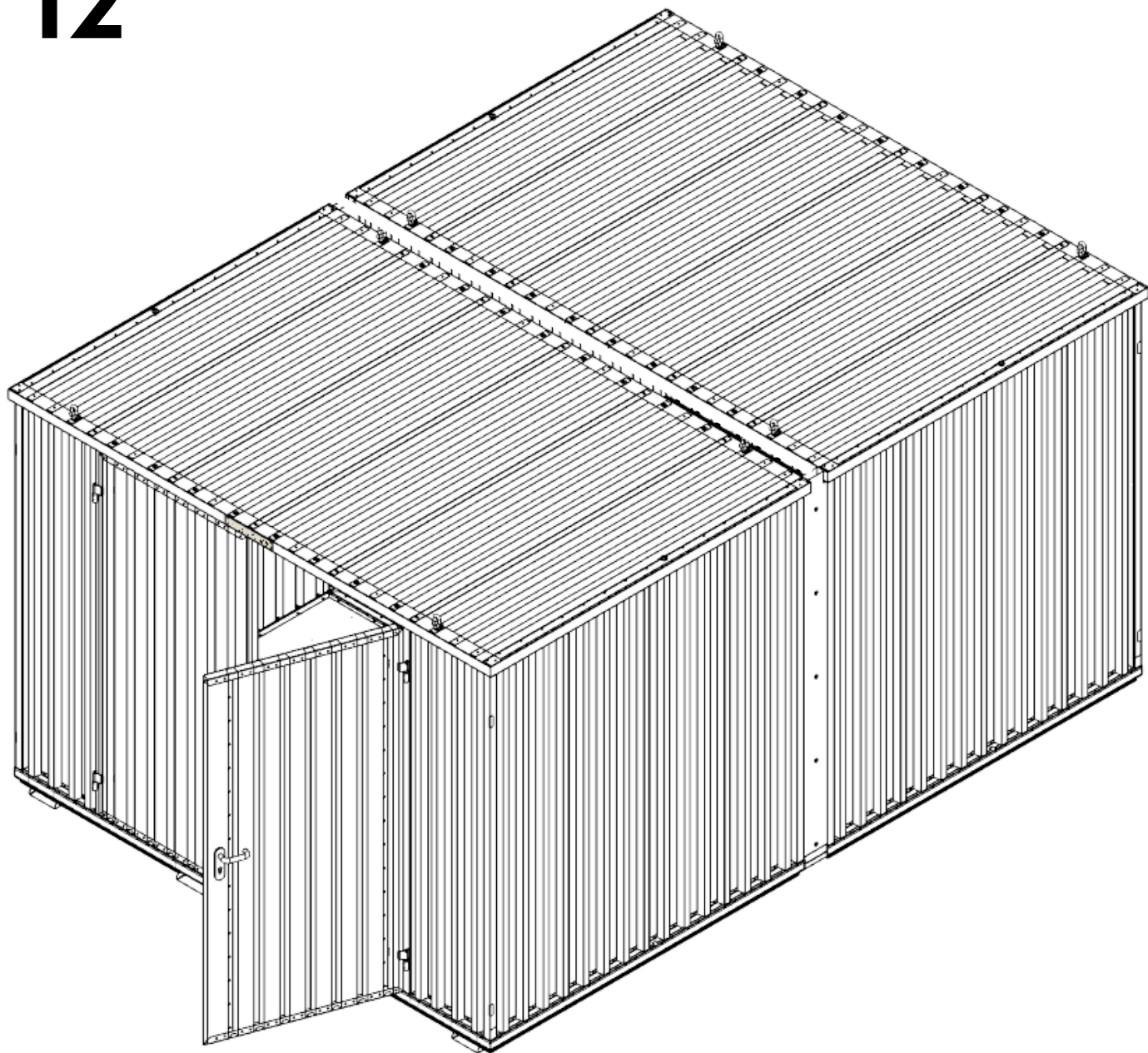

13

