

PRODUCT CODE:40.110.440.330

prefabase
Quick Build Solutions

Instructions and User Guide



40.0110
1x

40.0410
1x

40.0440/0210
1x

0220/0230
1x

0310
1x

40.0510
1x

0099.61.101
2x

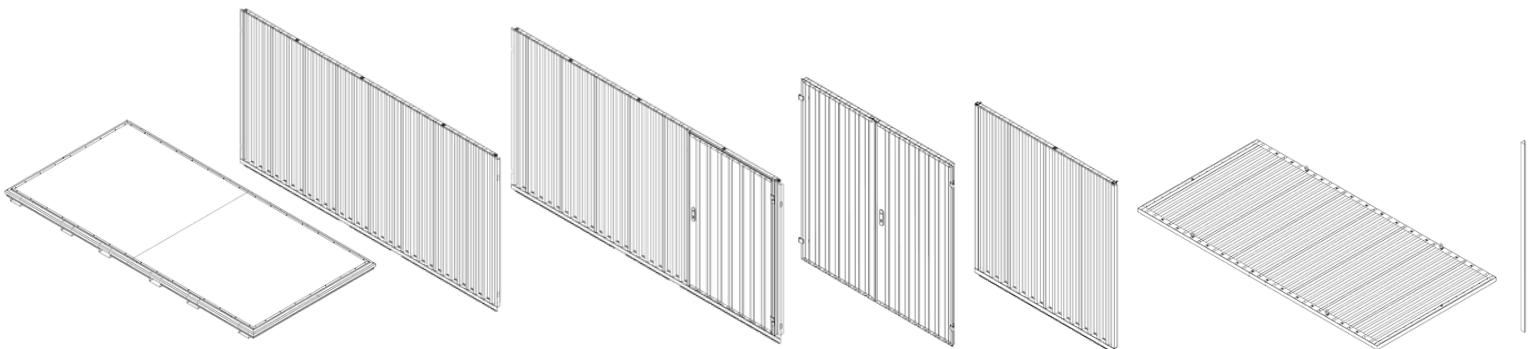



12x



2x



1x



2x

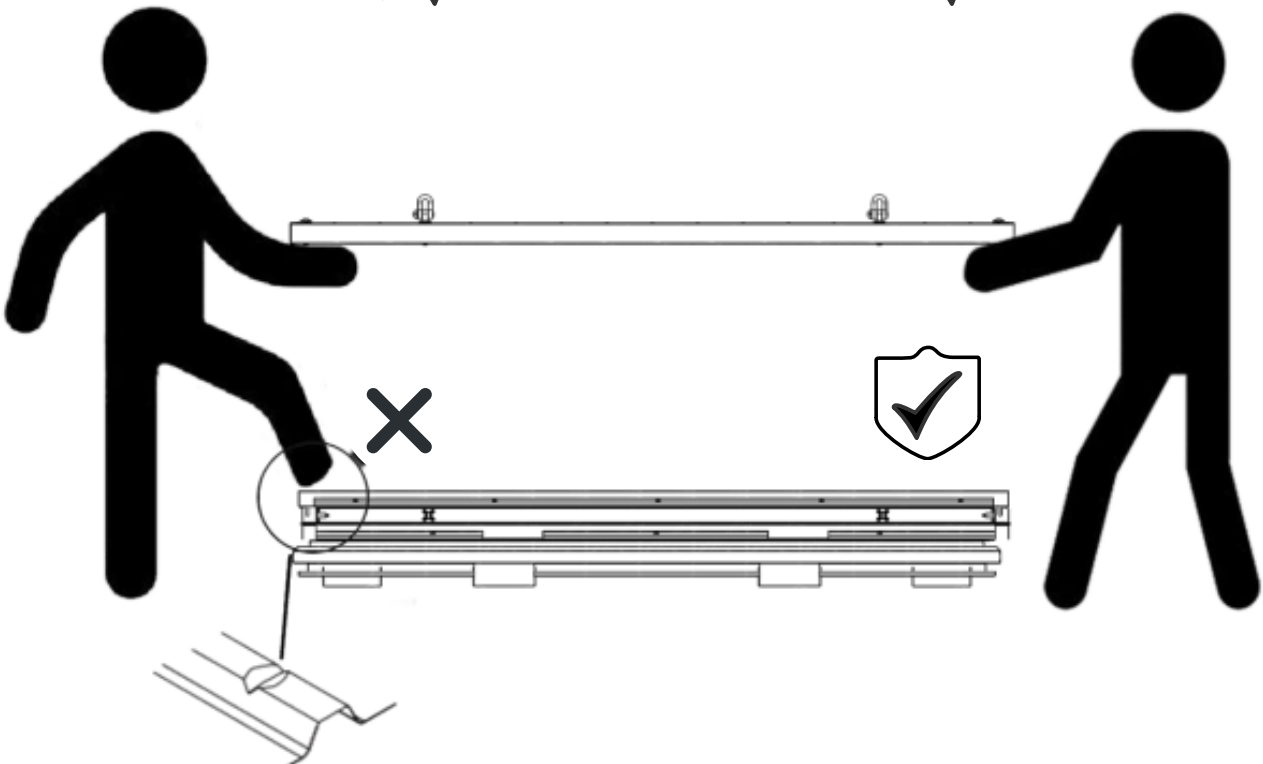

1

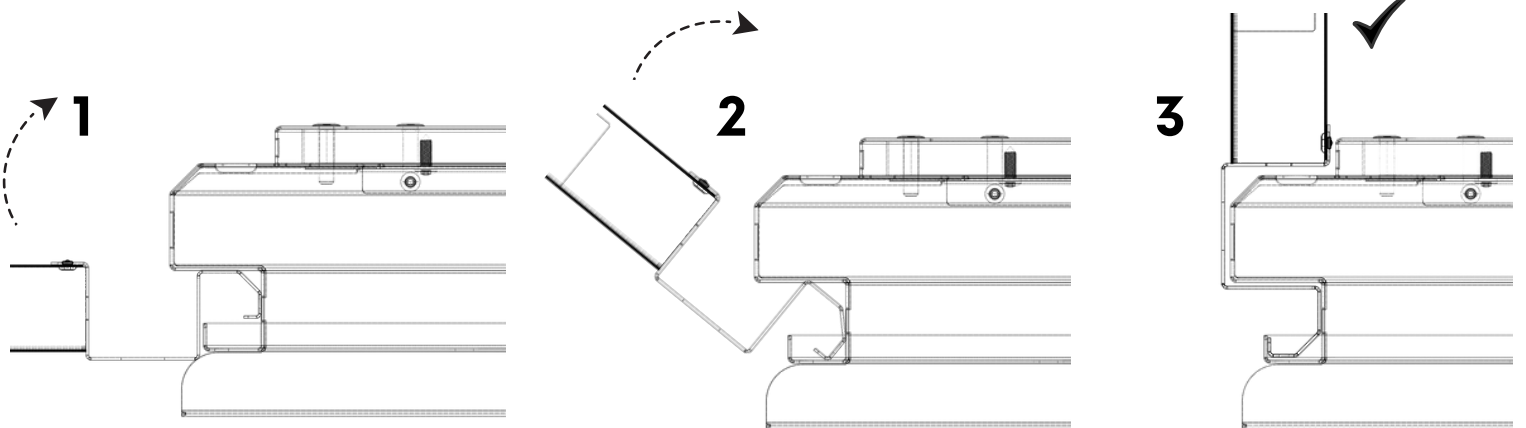
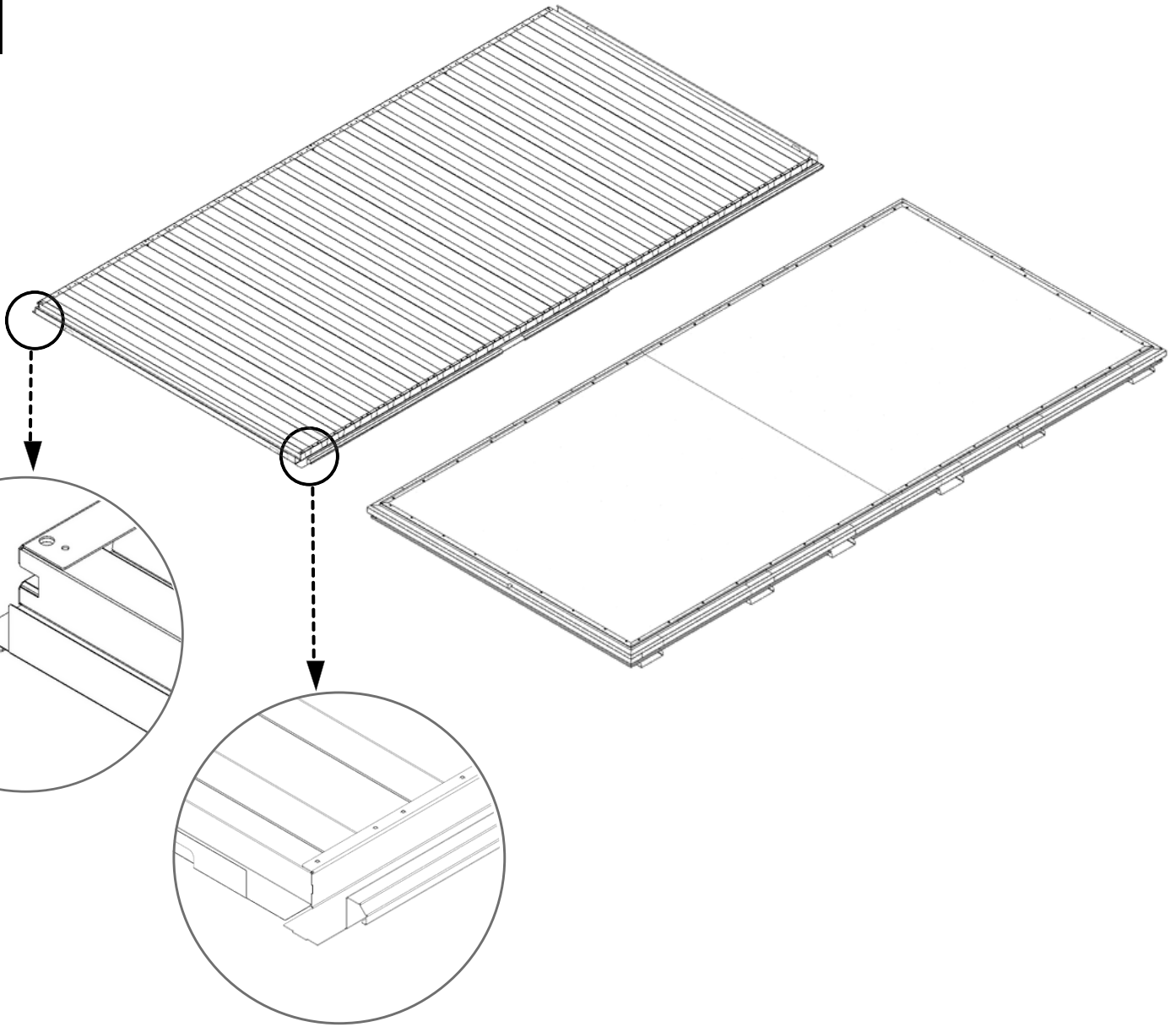

2

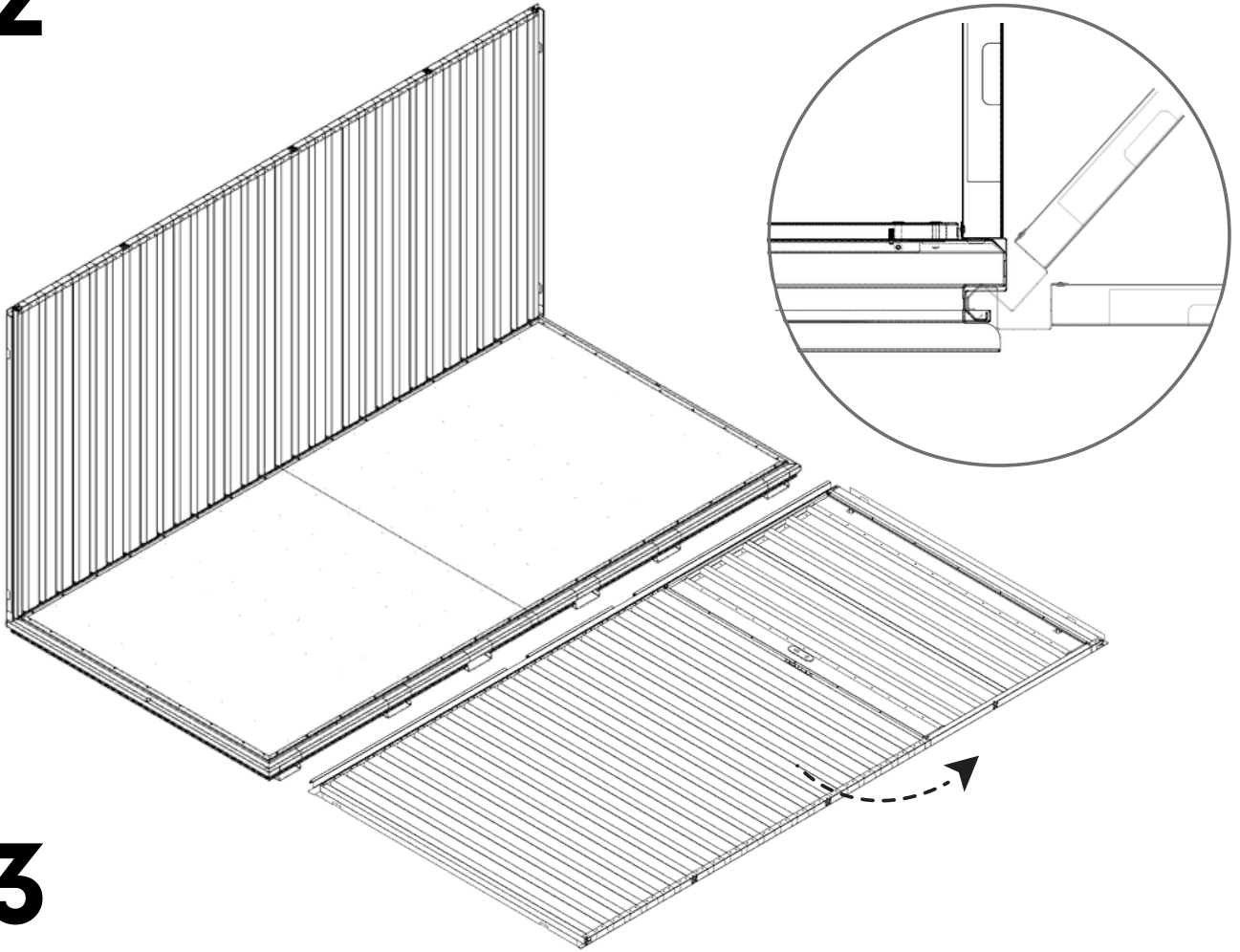

3

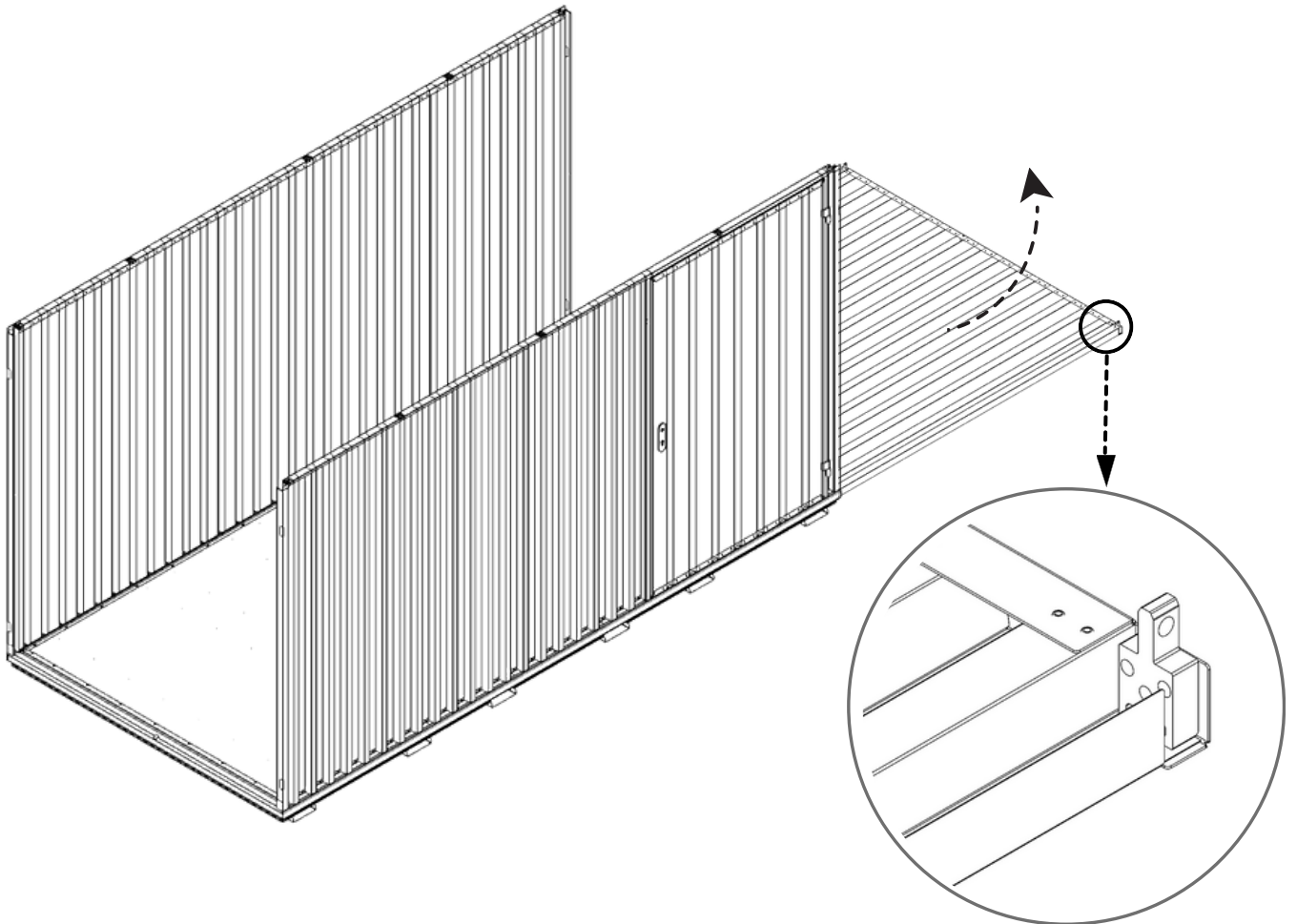

3.1

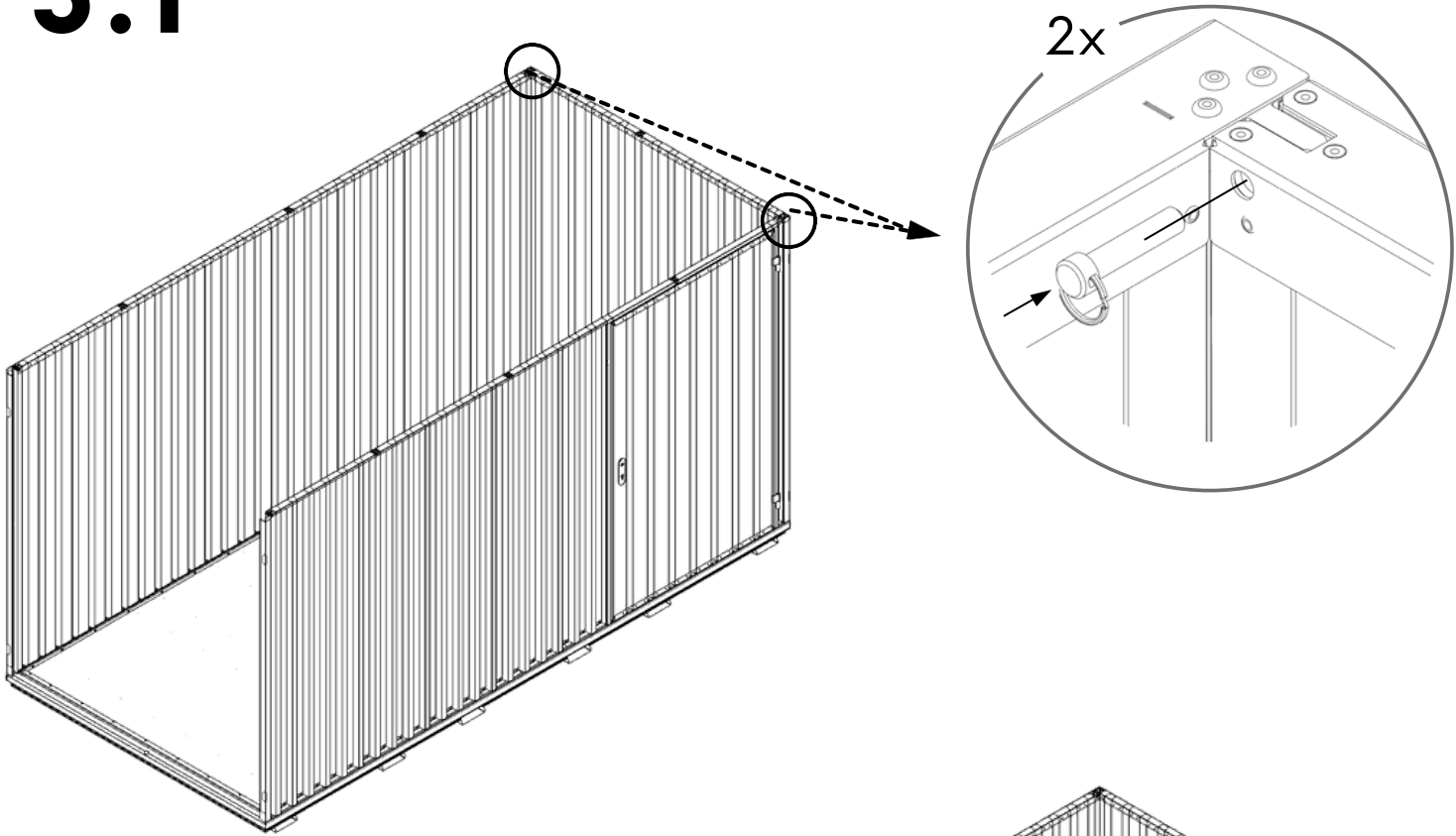



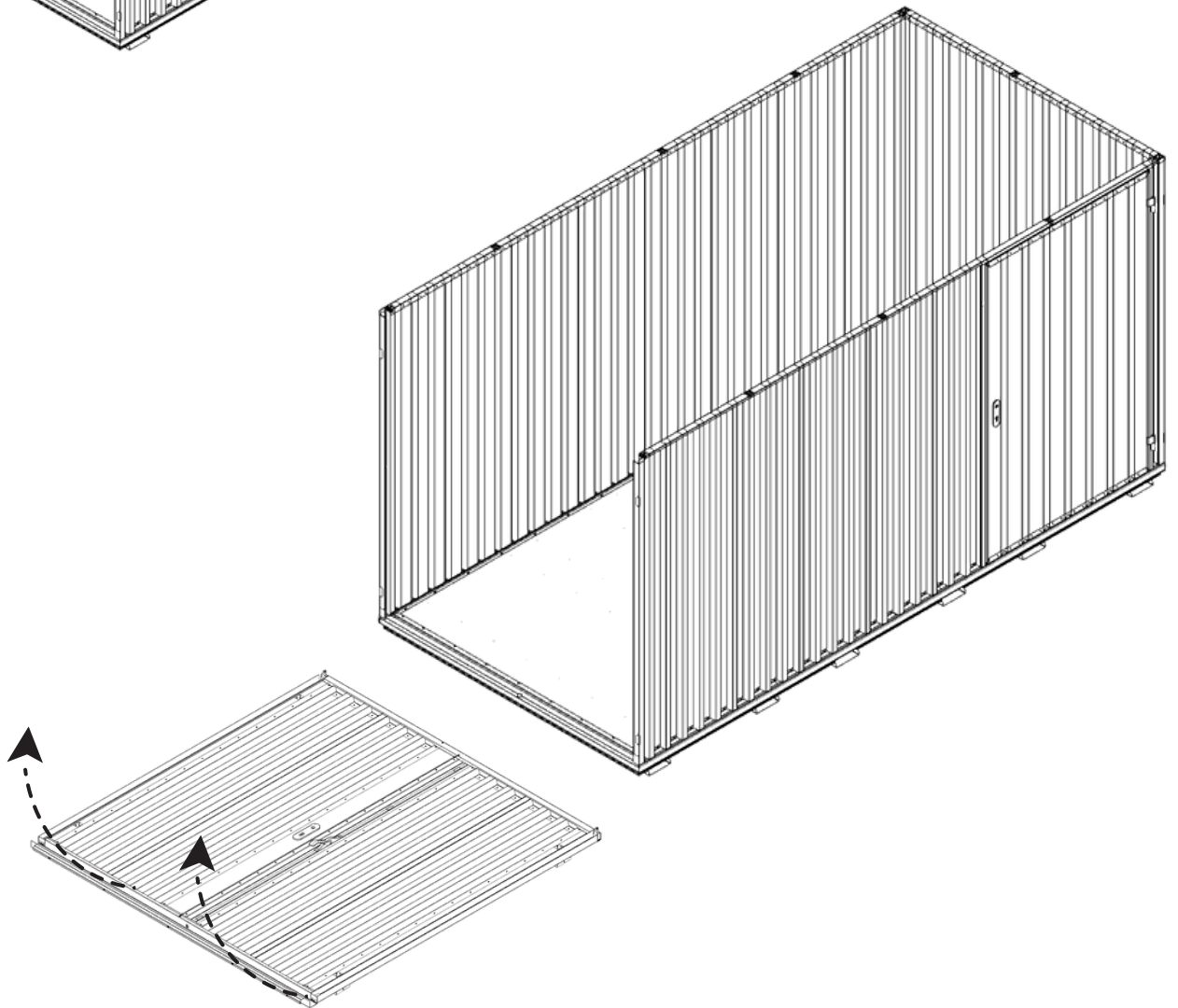



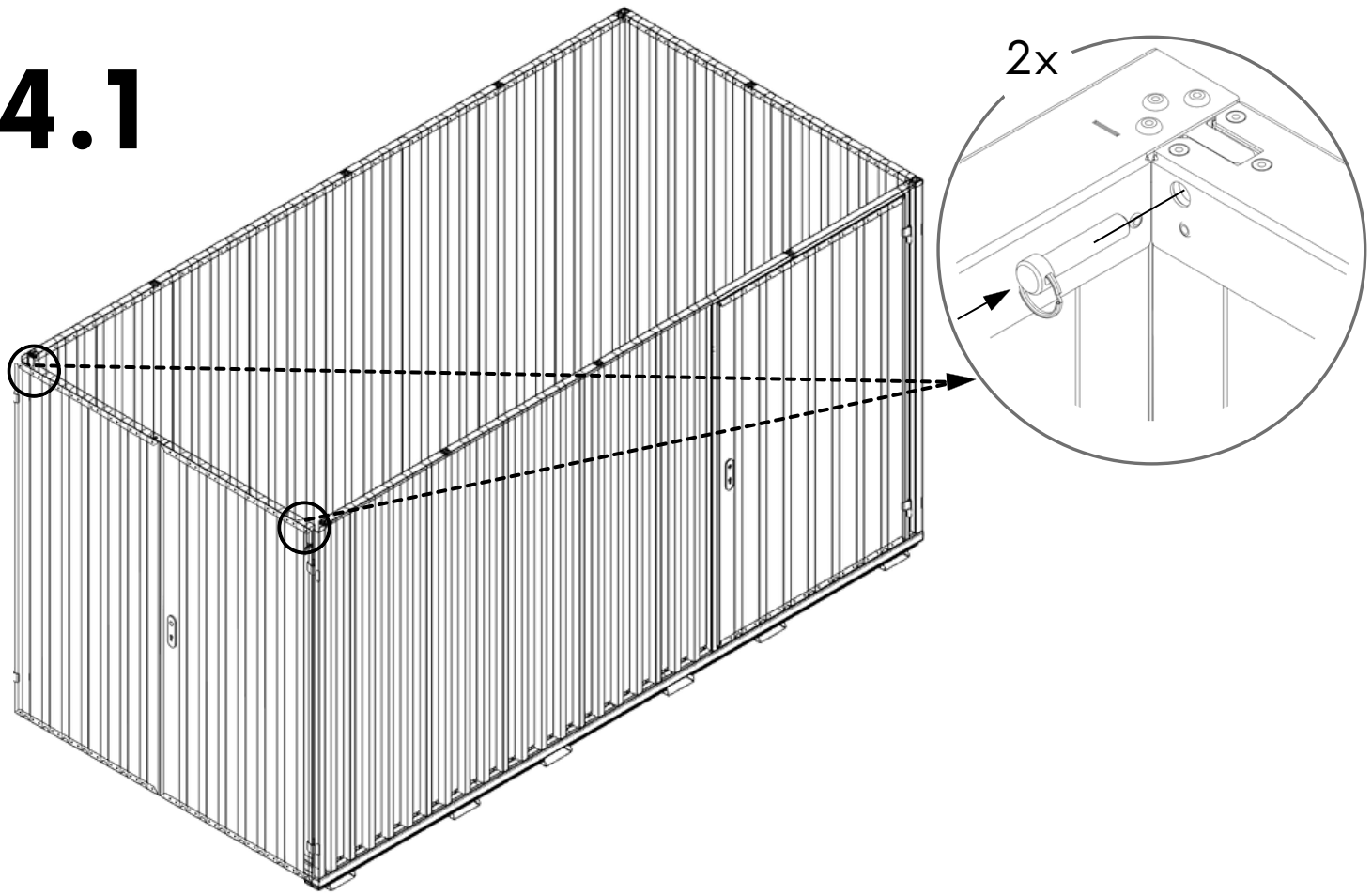

4



4.1



 336 KG	 3 TON	 1640 MM	Model Code: 30.110.440 Production Tracking Code:X09.1.30.440    9001 14001 50001	  
---	--	--	--	---

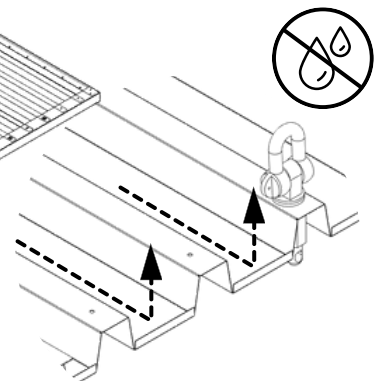
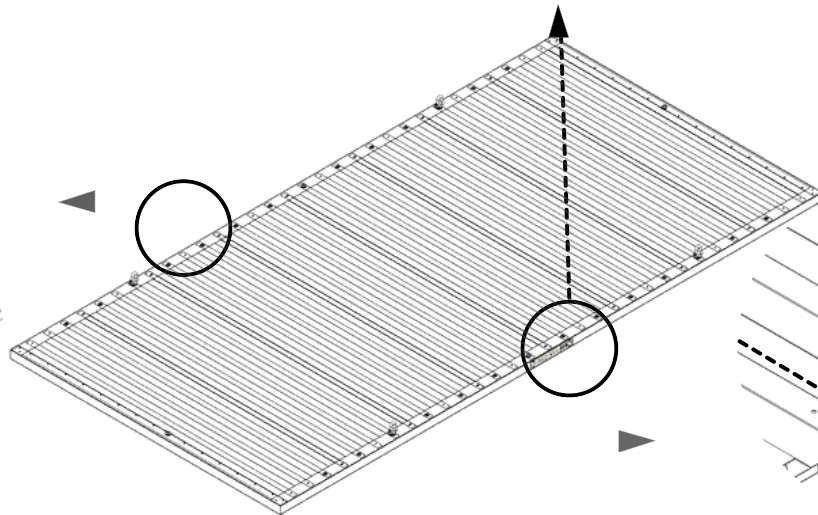
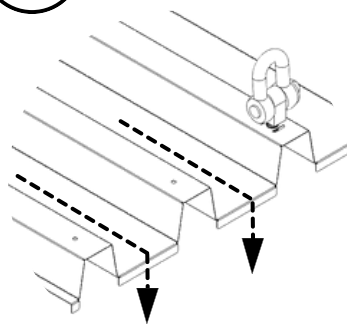

5

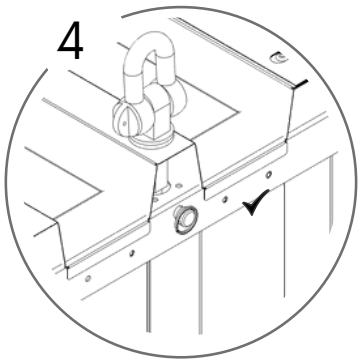
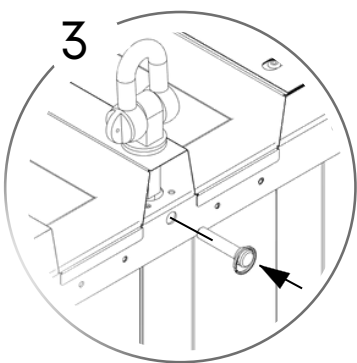
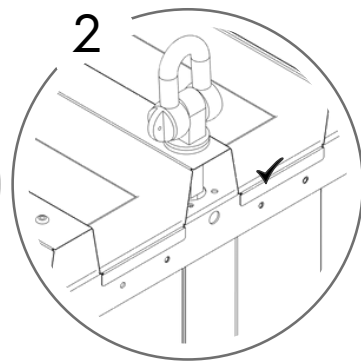
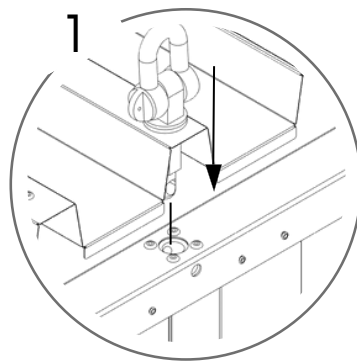
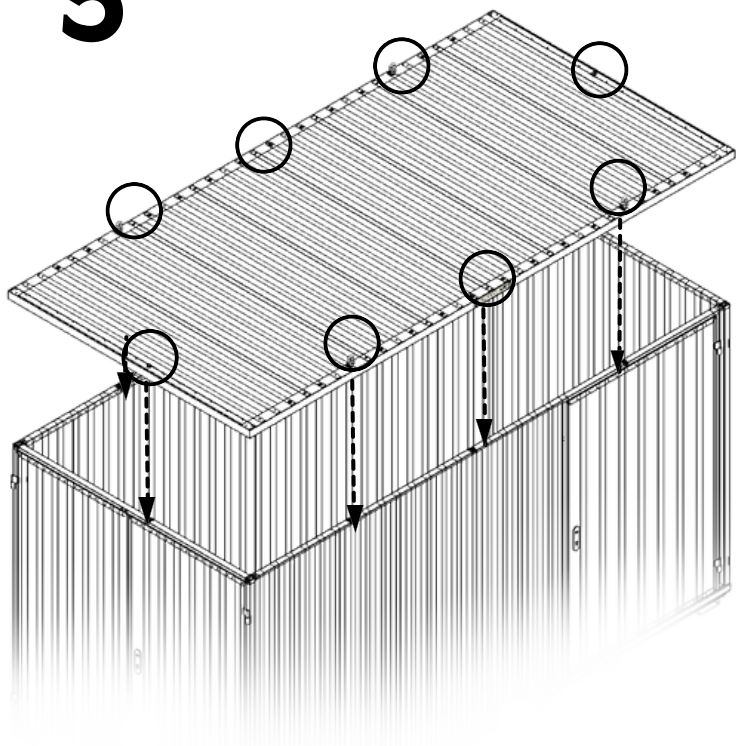

6

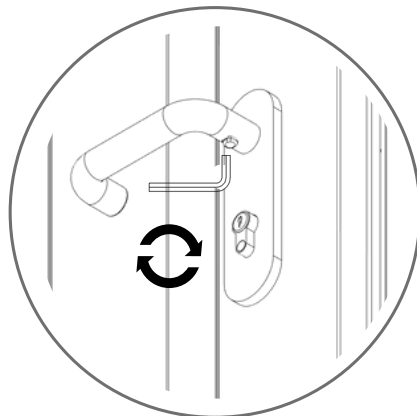
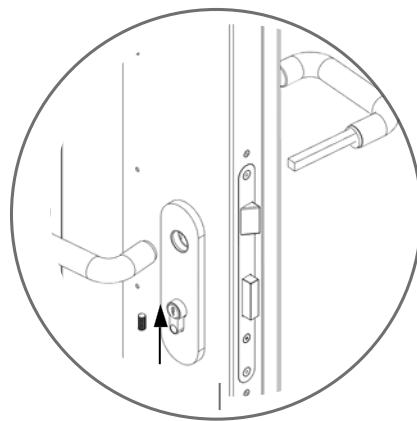
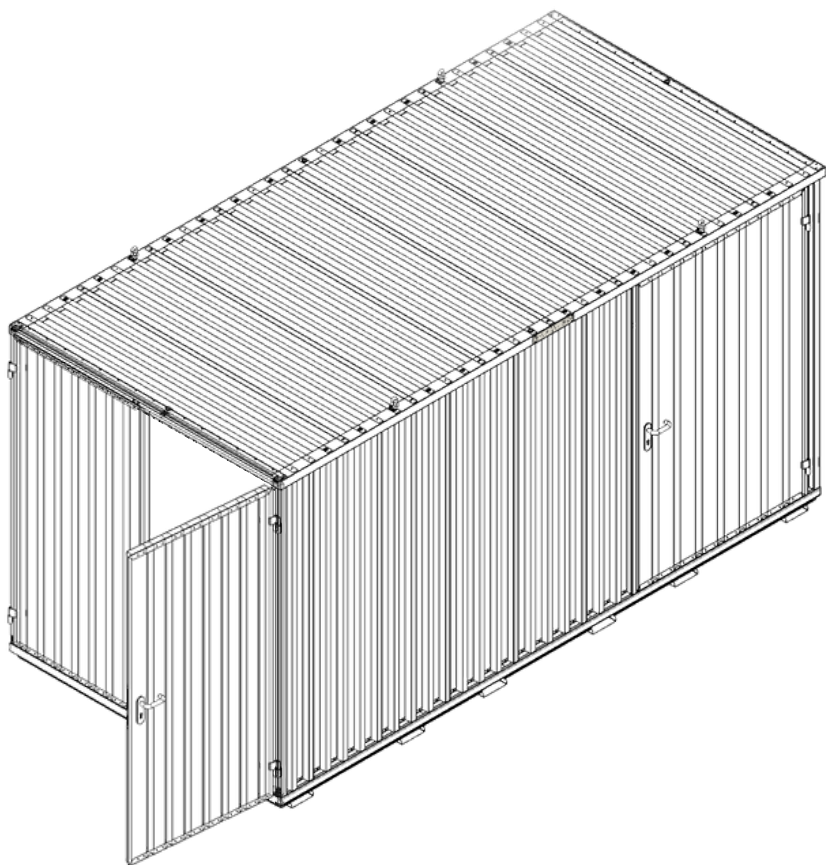

7

