

PRODUCT CODE:50.110.420.320

prefabase
Quick Build Solutions

Instructions and User Guide

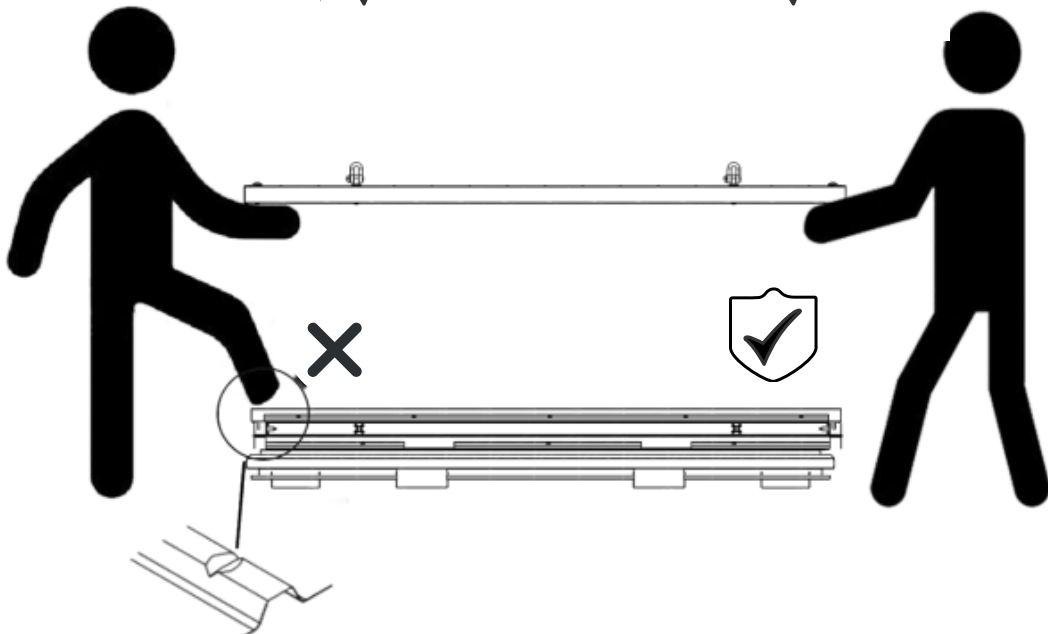
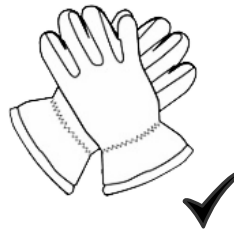

50.0110
1x

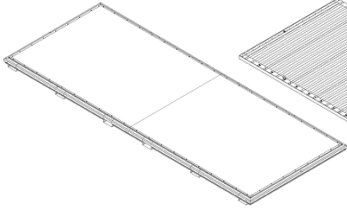

50.0510
1x

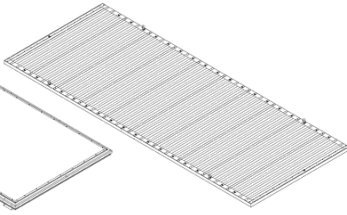

50.0410
1x

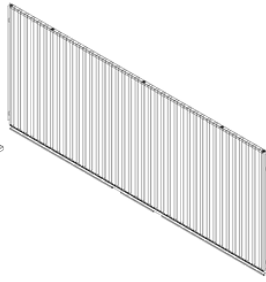

50.0420
1x

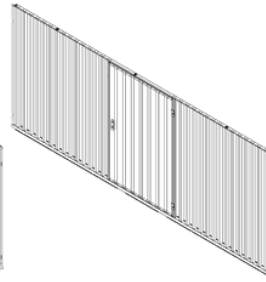

0310
1x

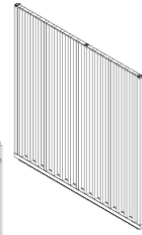

0320
1x



61.101
4x



12x

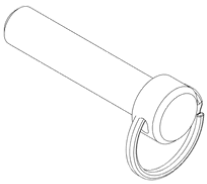

2x

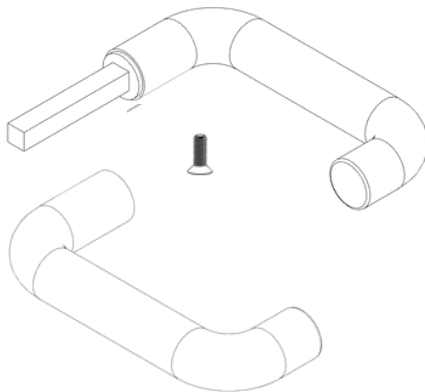

1x

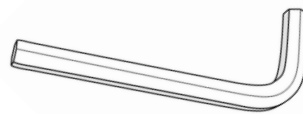

2x



1

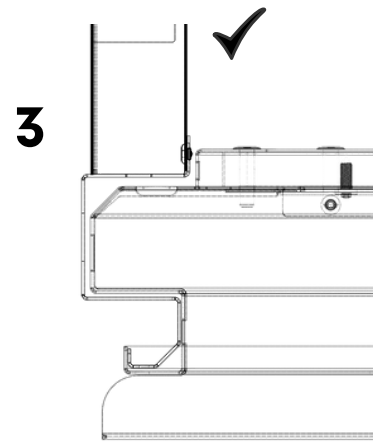
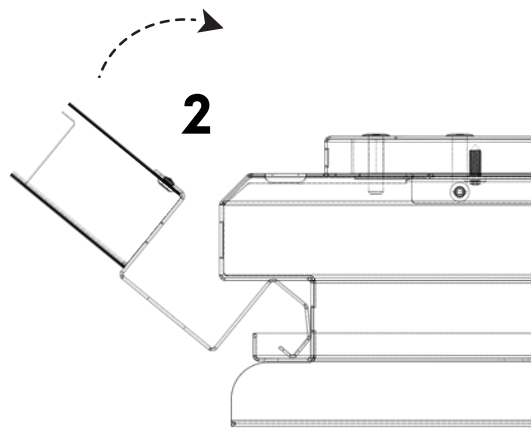
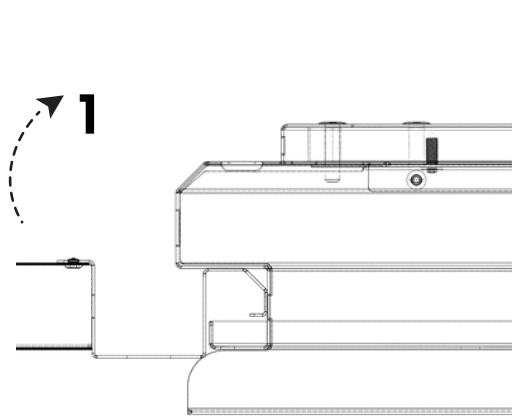
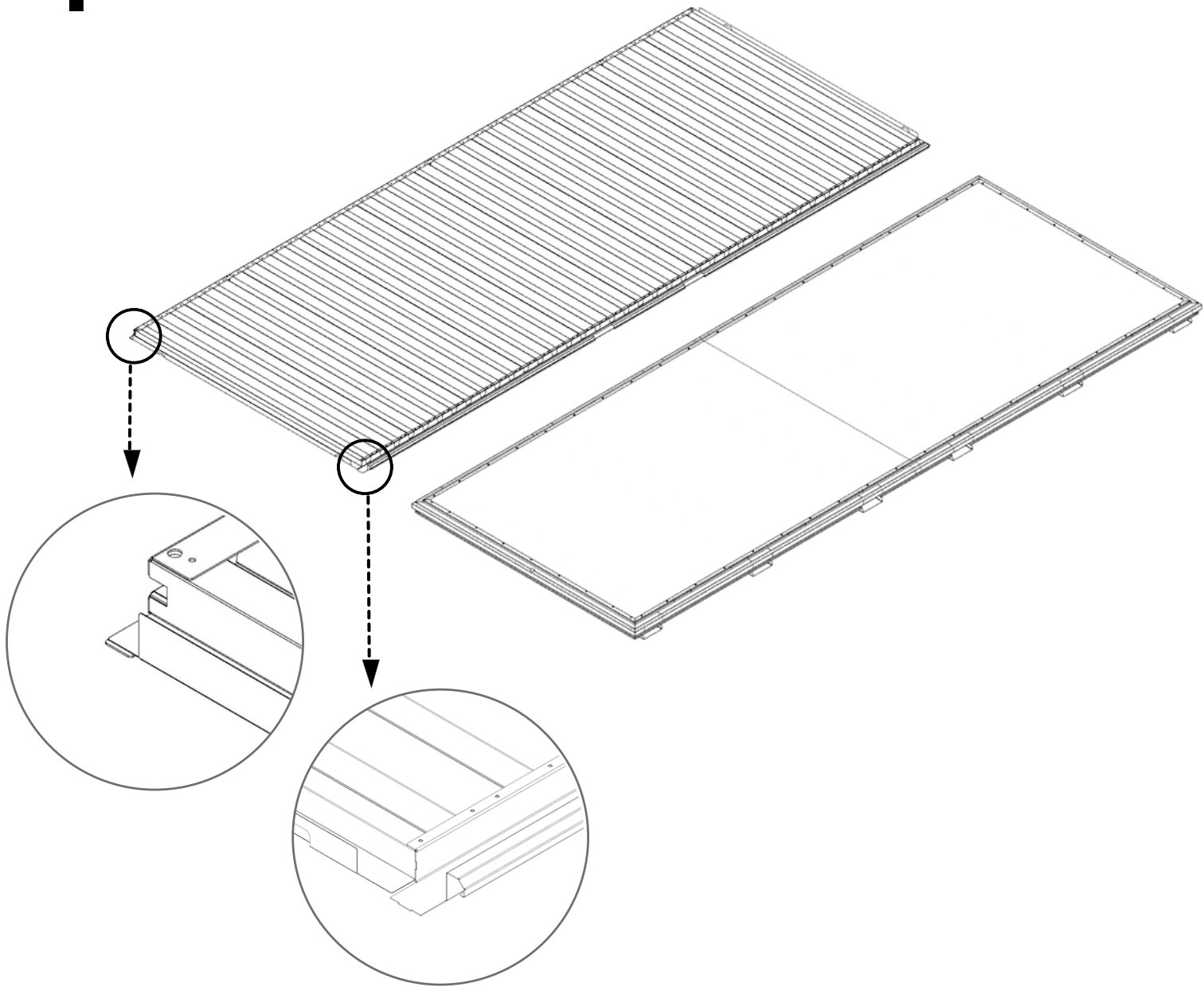

2

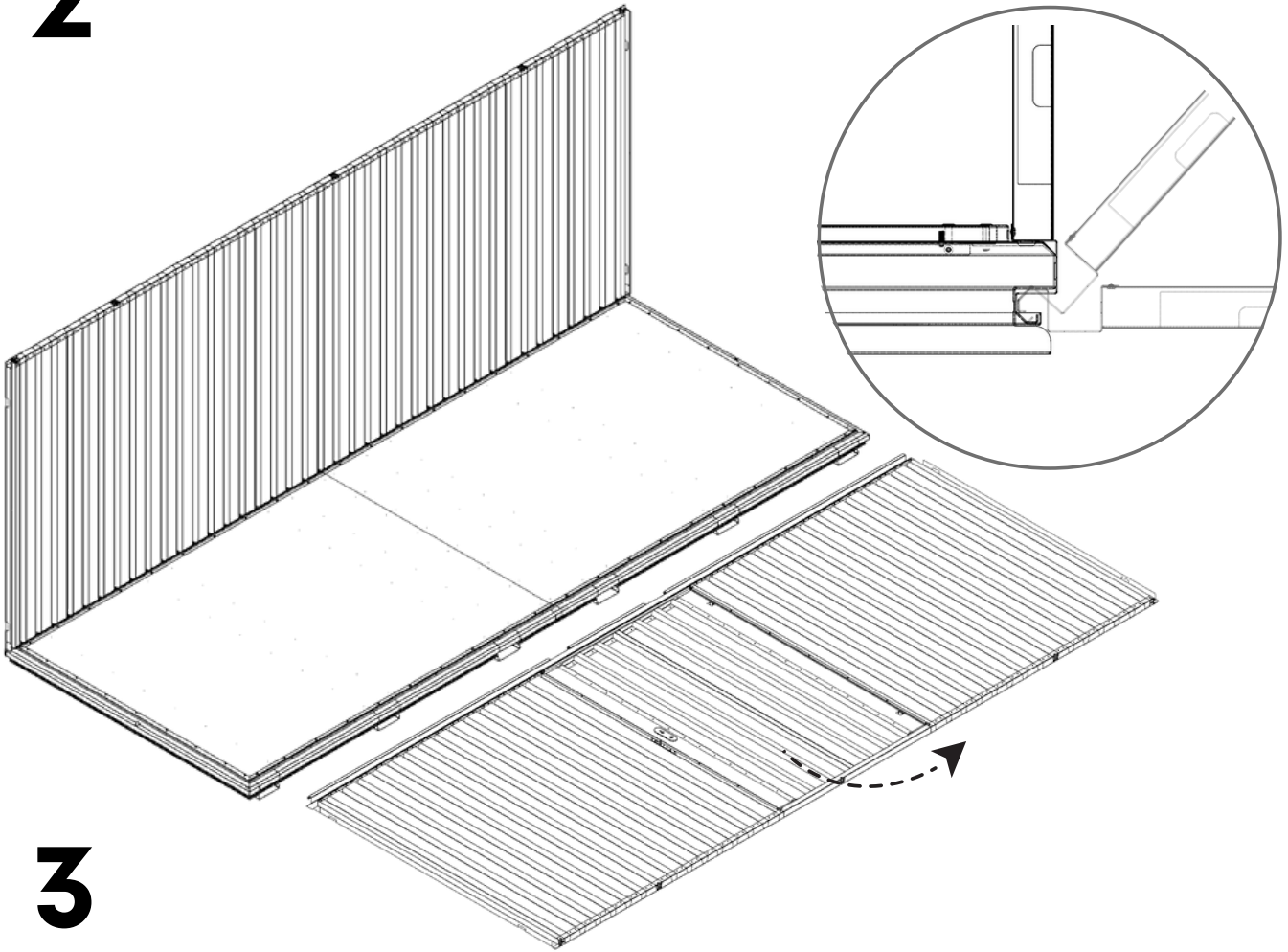

3

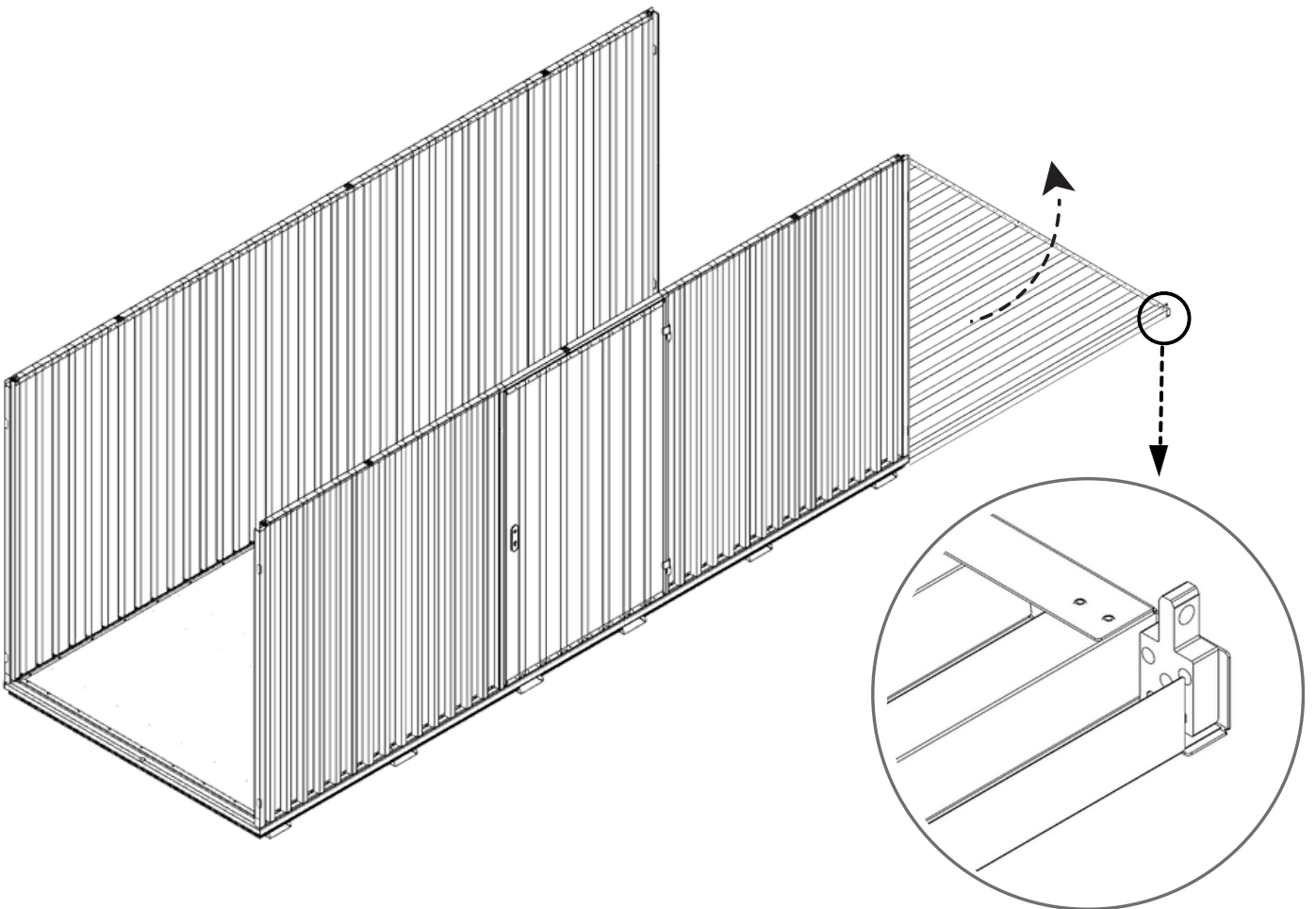

3.1

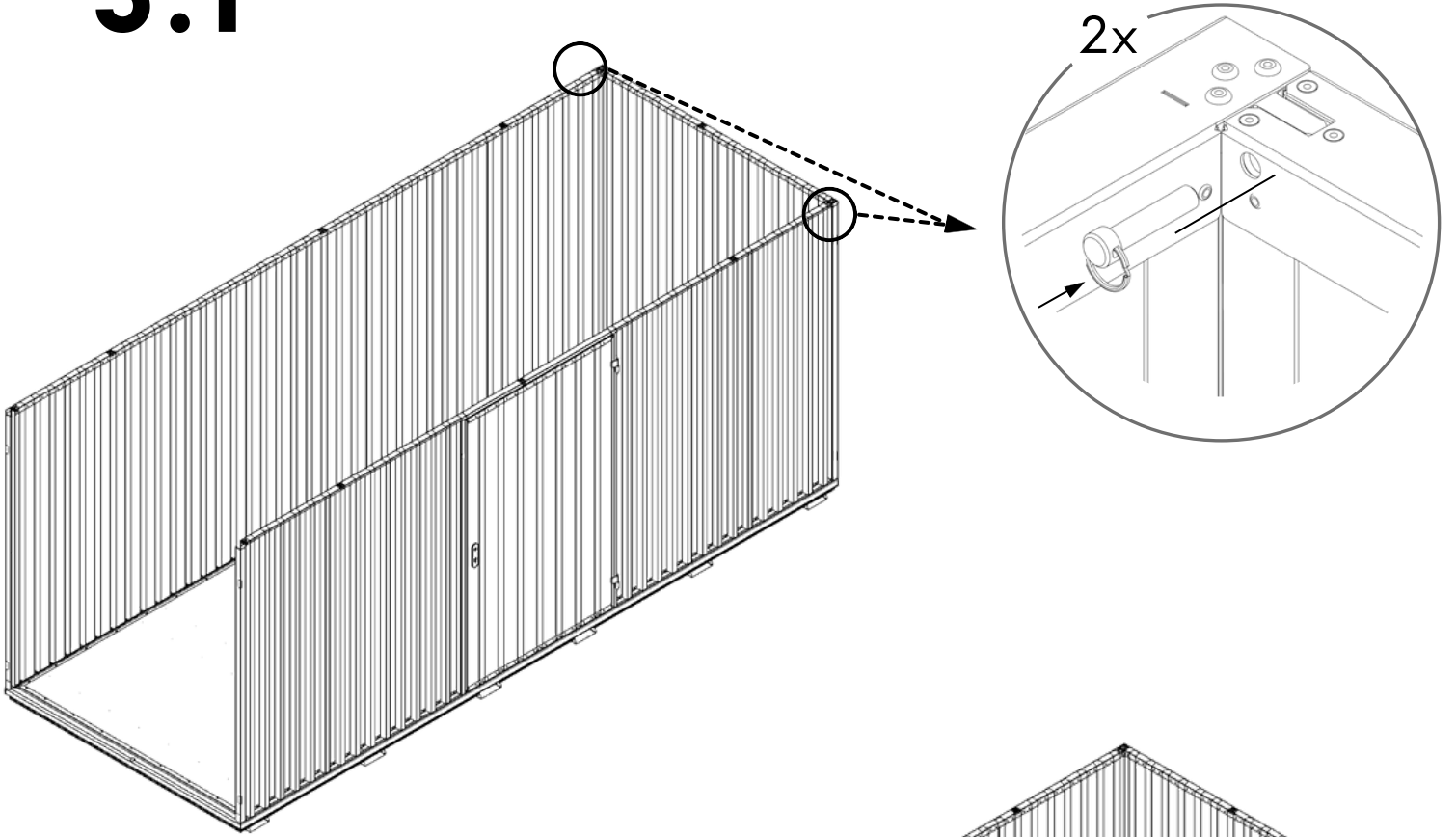



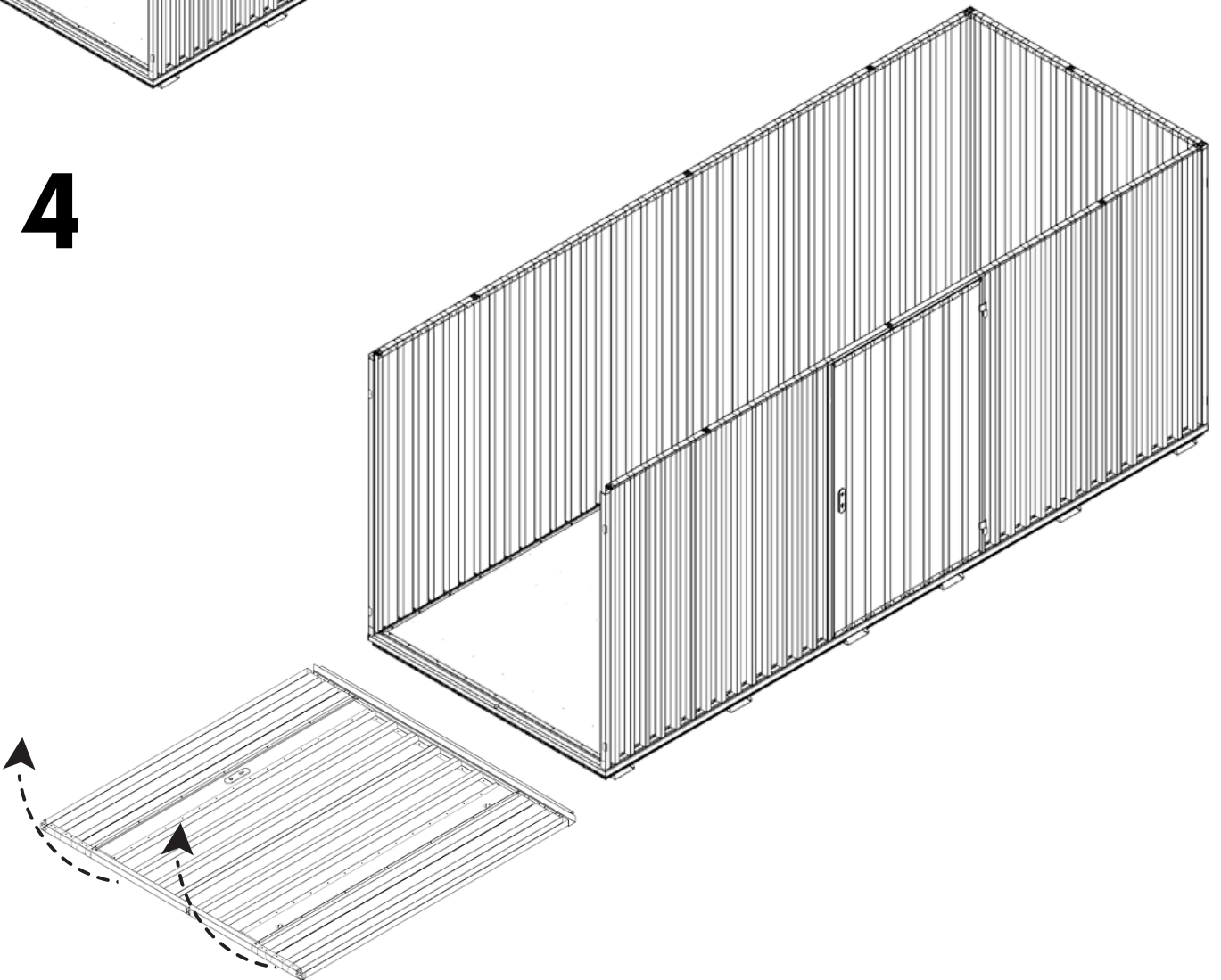



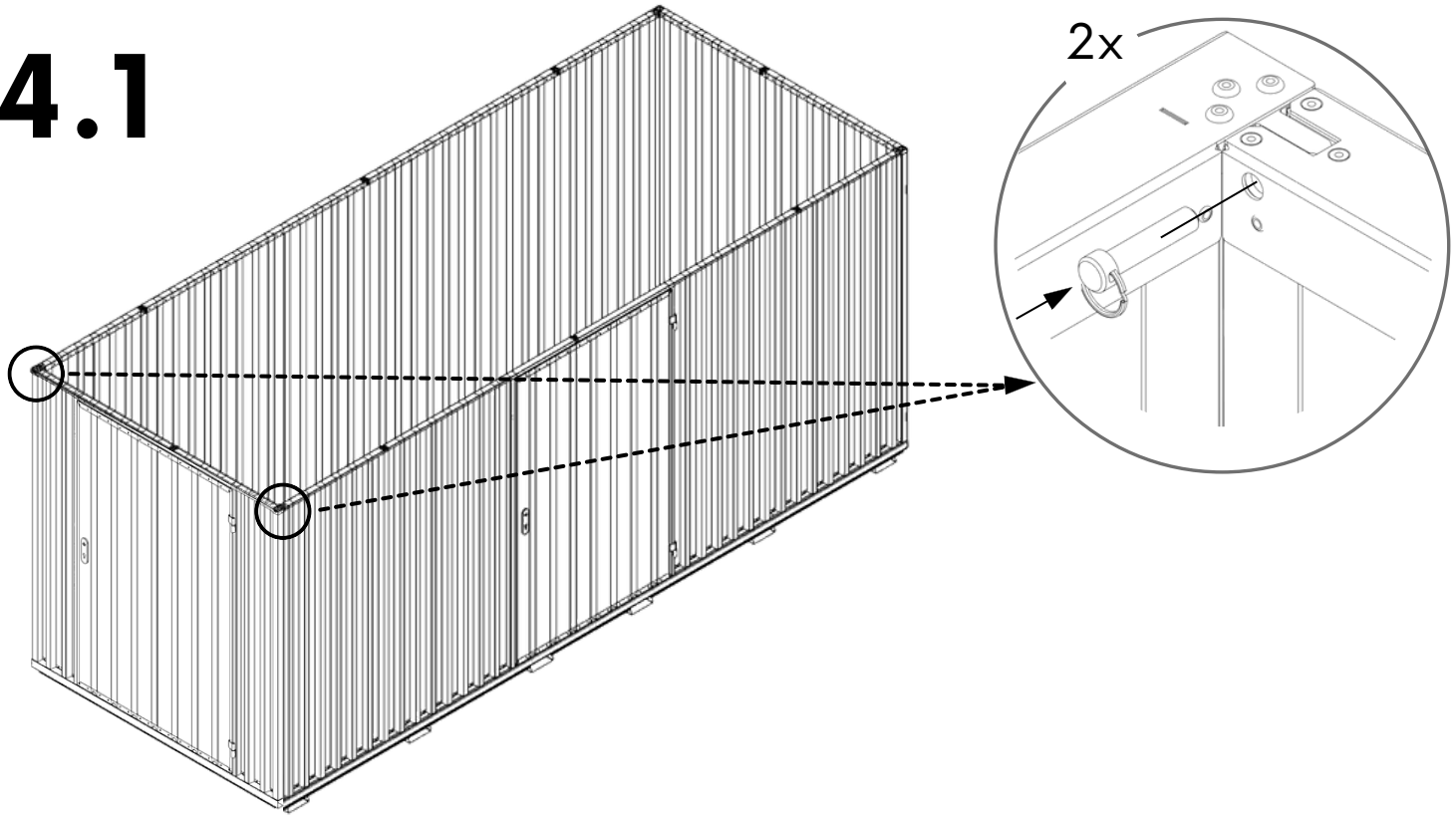

4



4.1



 509 KG	 1640 MM	Model Code: 50.110.420.320 Production Tracking Code:/X09.1.50.420.320  9001  14001  50001	 	
---	--	---	---	---

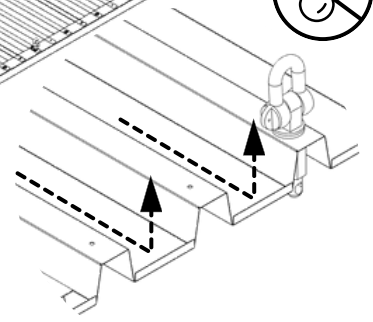
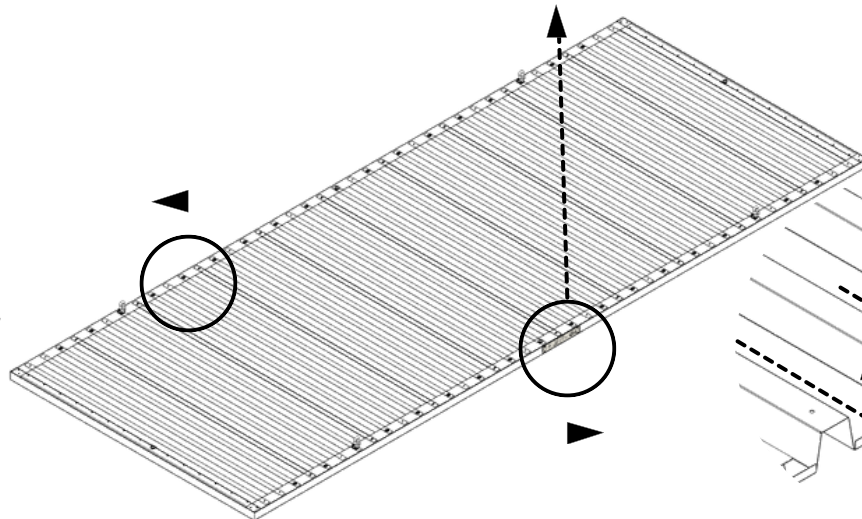
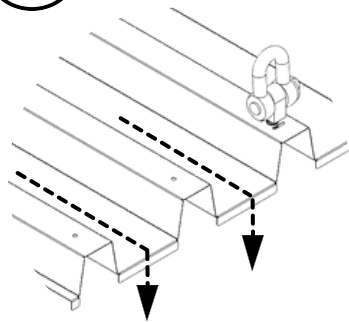

5

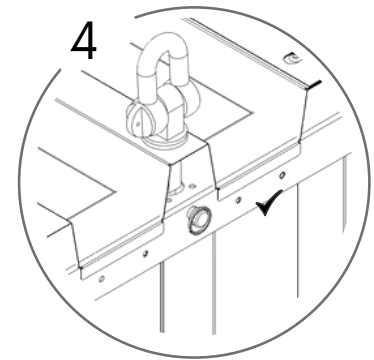
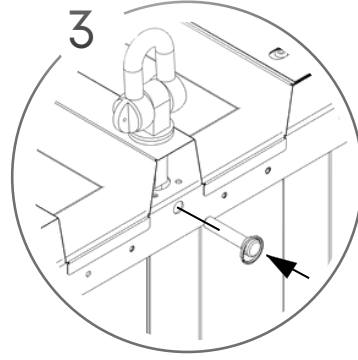
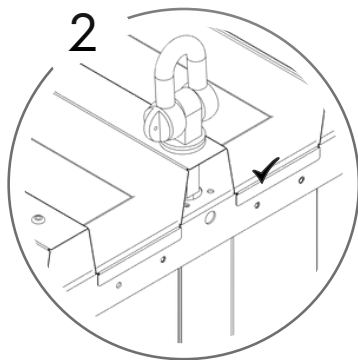
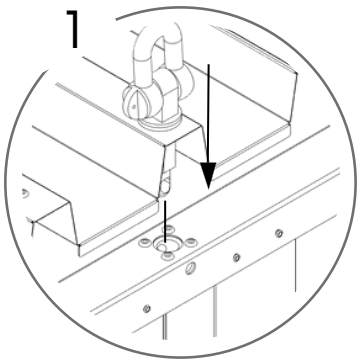
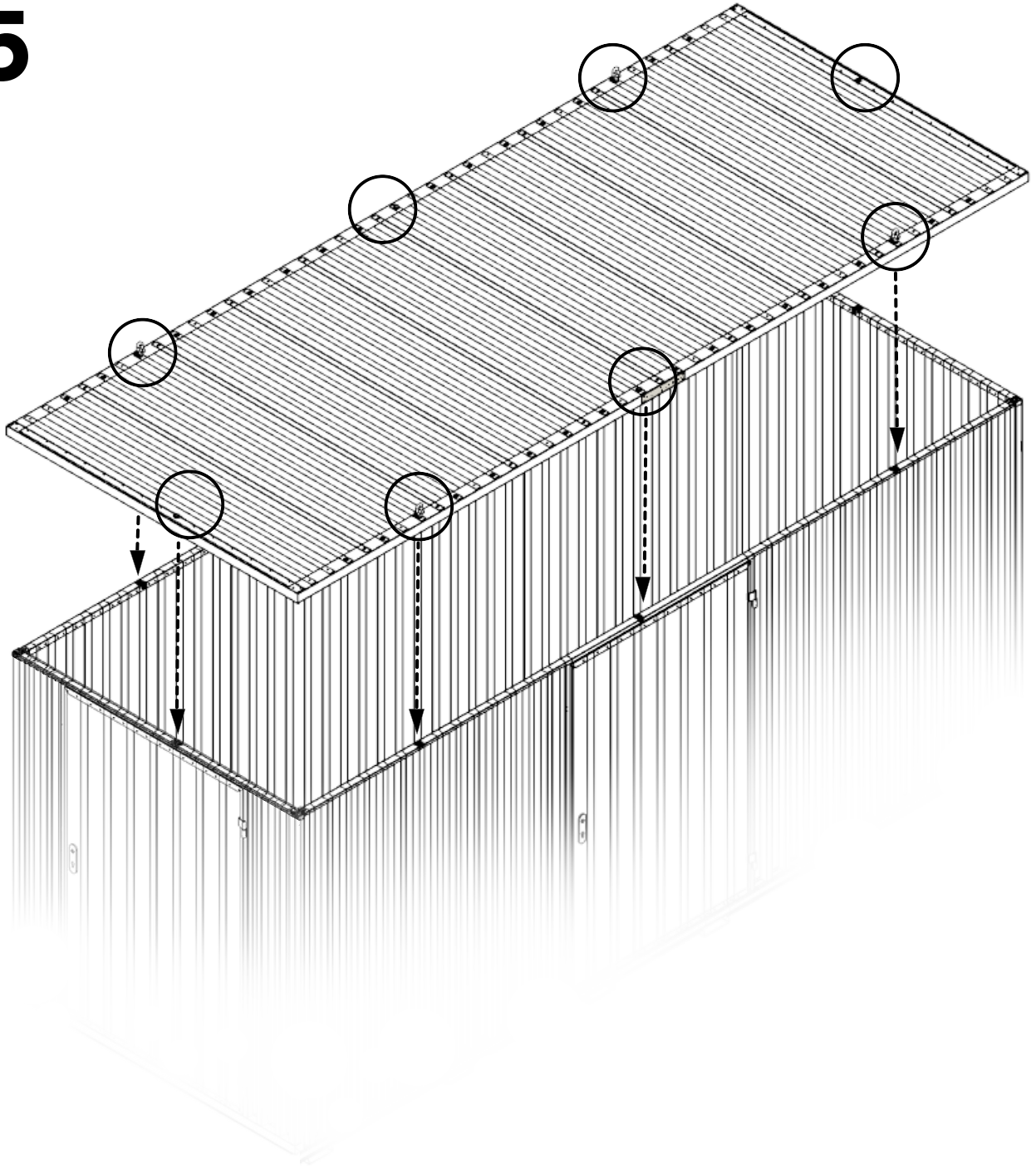

6

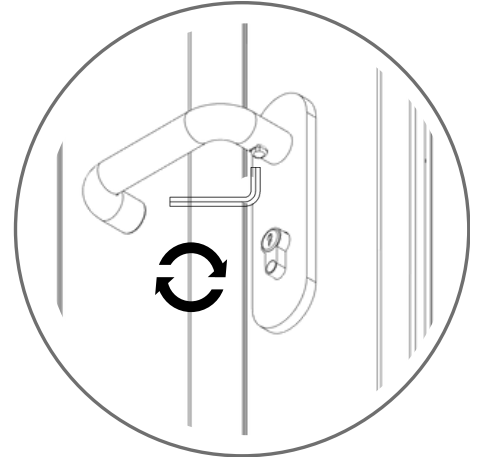
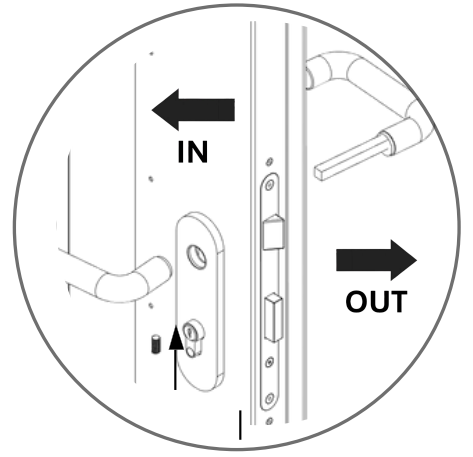
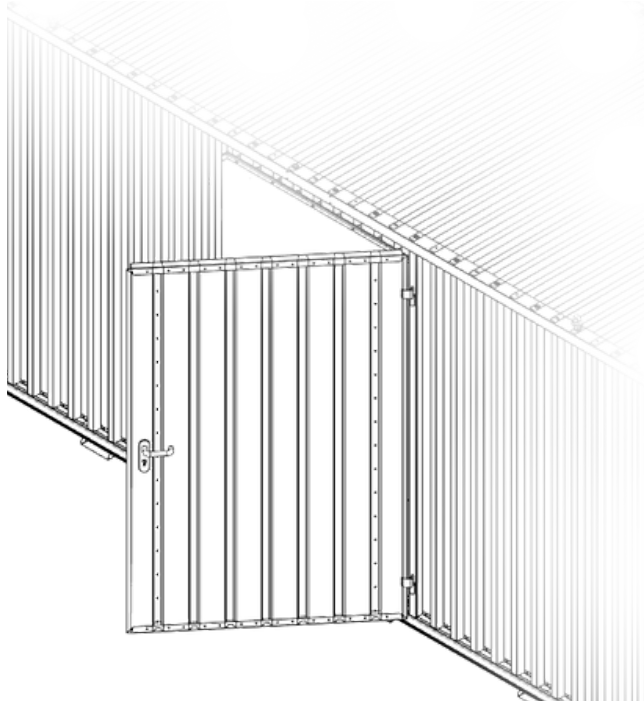

7

