

PRODUCT CODE:50.110.430.330

prefabase
Quick Build Solutions

Instructions and User Guide

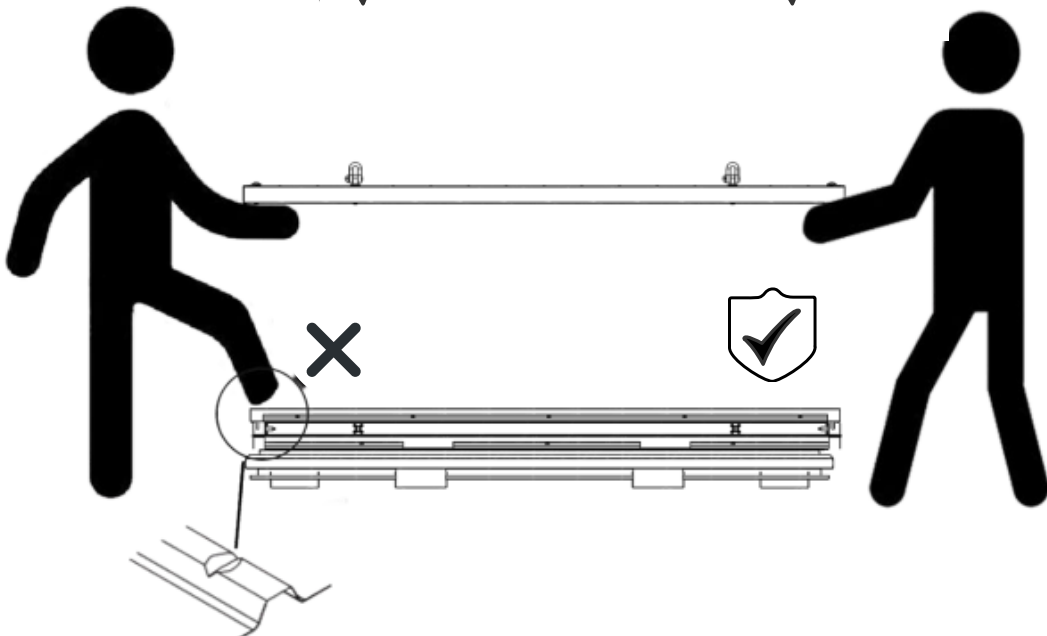
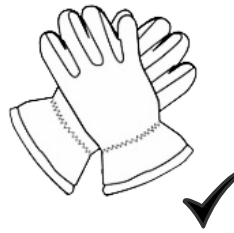
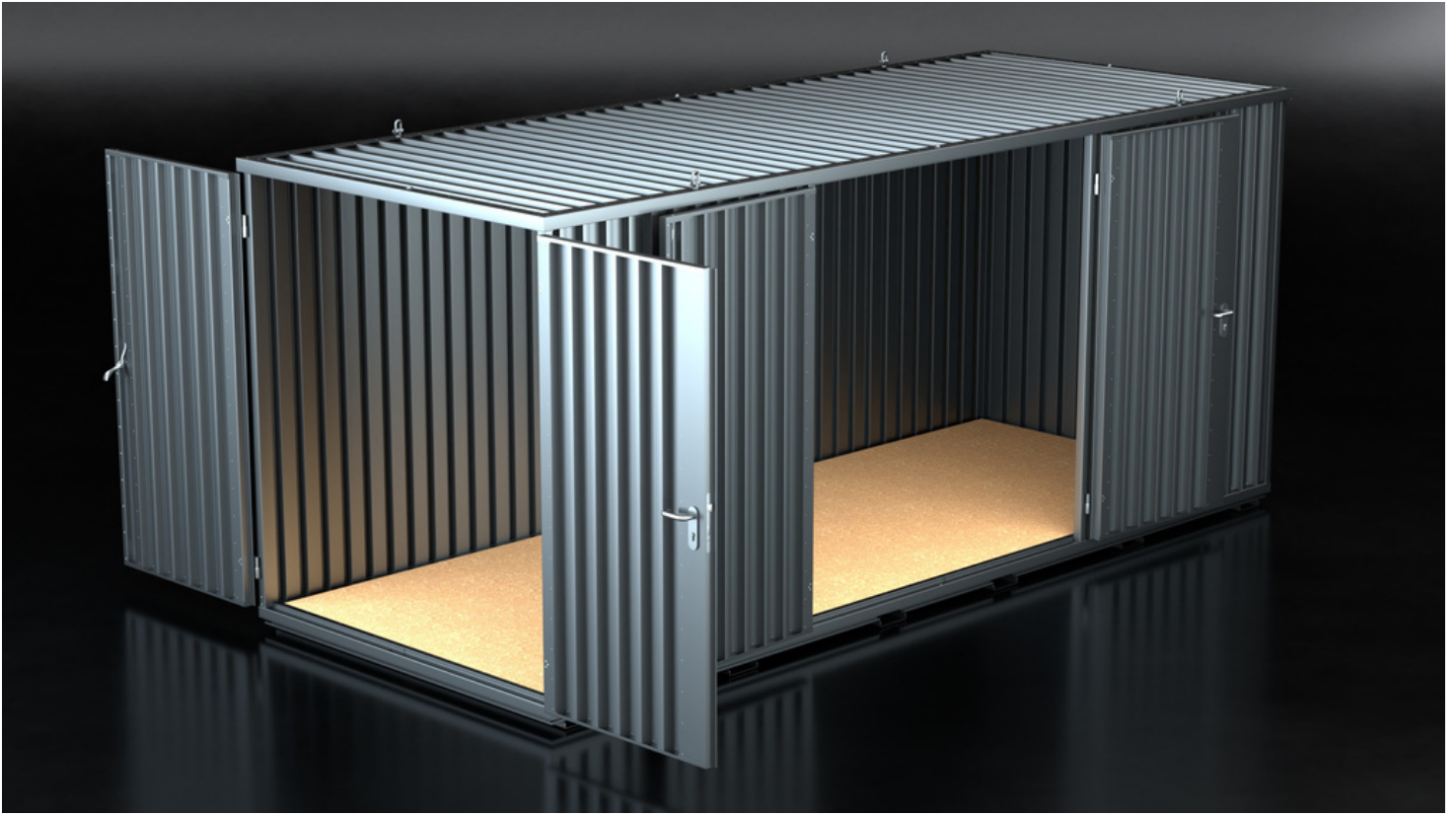

50.0110
1x

50.0510
1x

50.0410
1x

50.0430
1x

0310
1x

0330
1x

61.101
2x

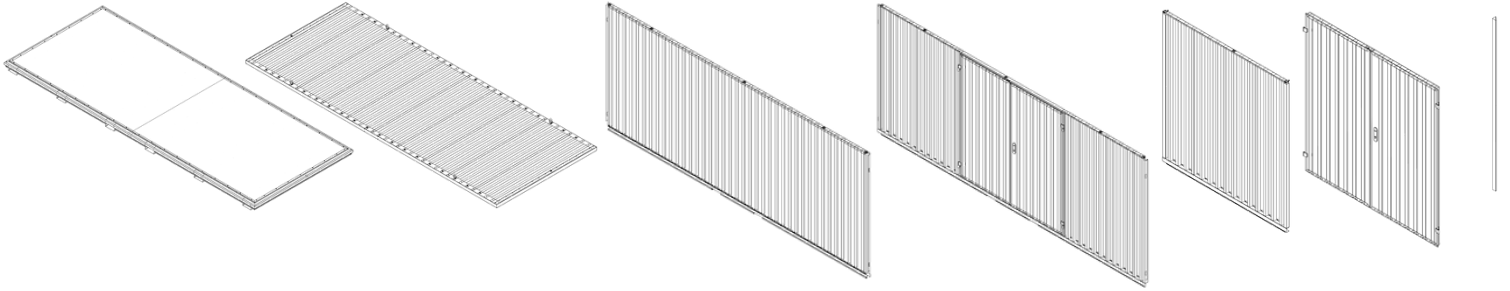

12x

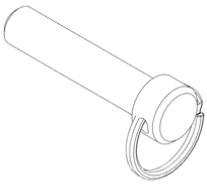

2x

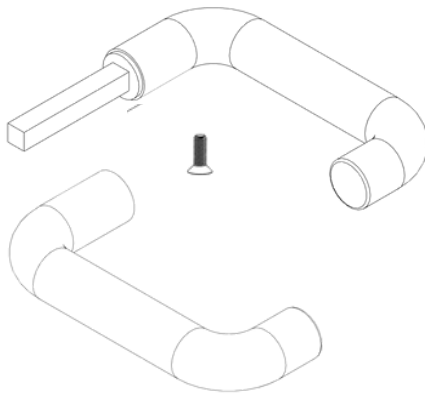

1x

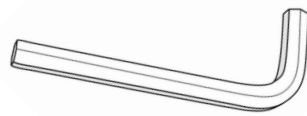

2x



1

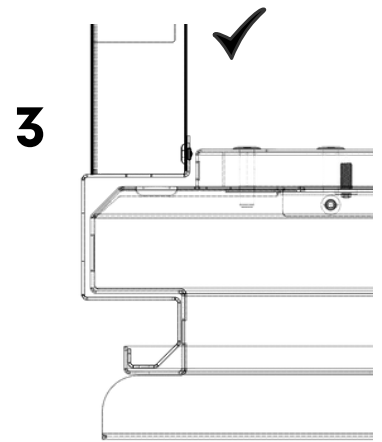
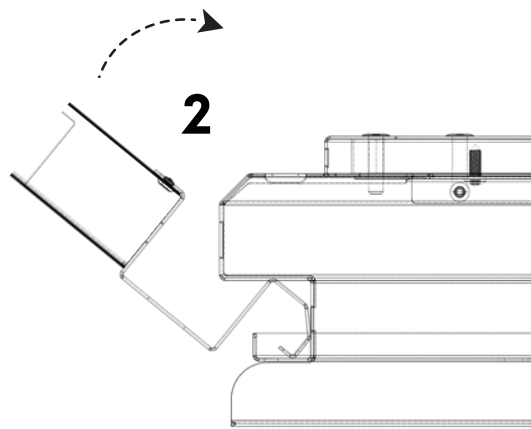
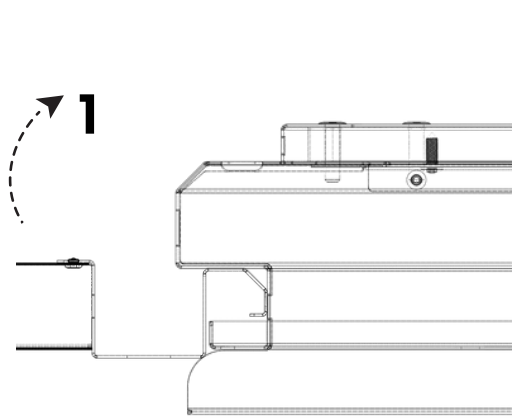
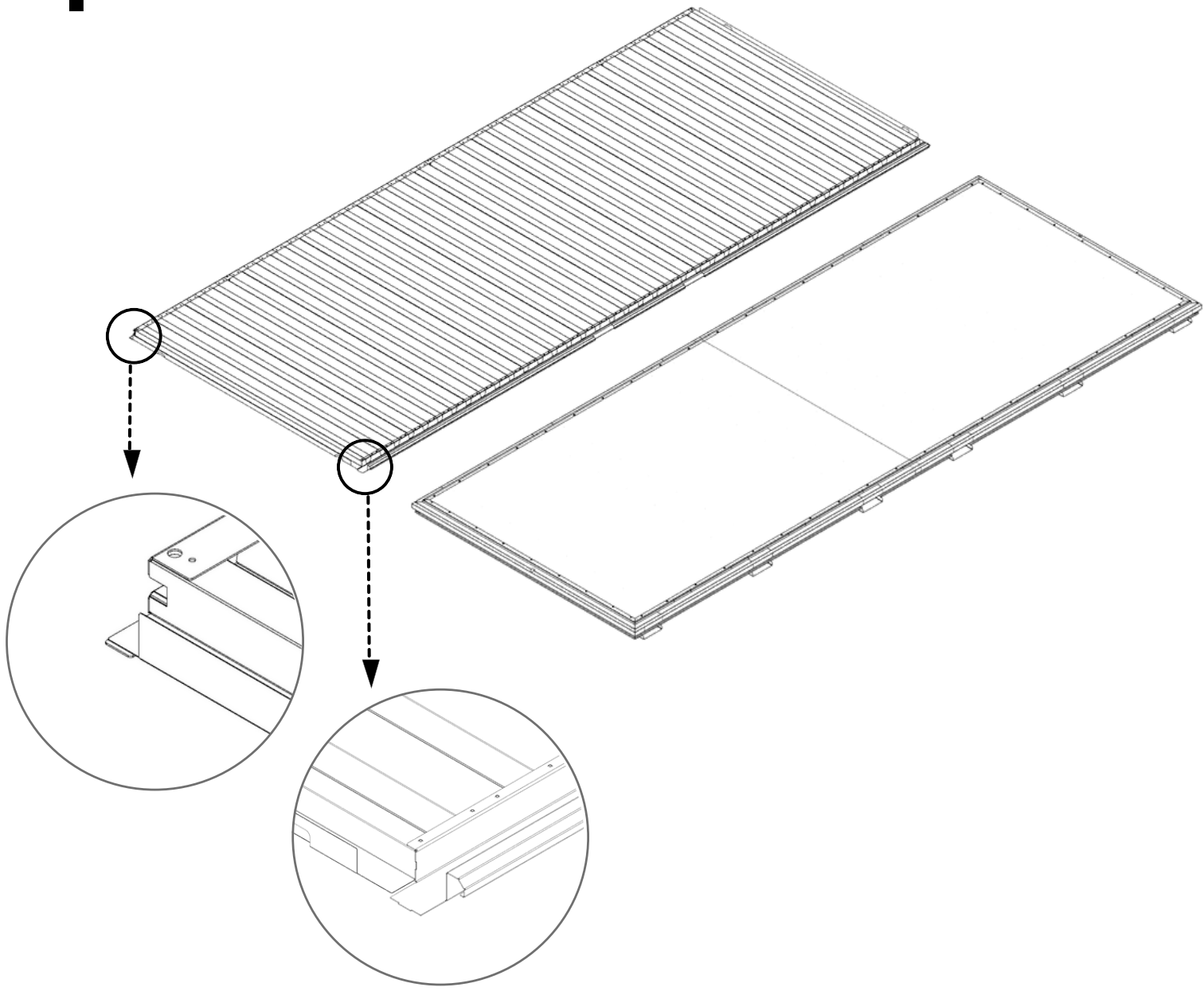

2

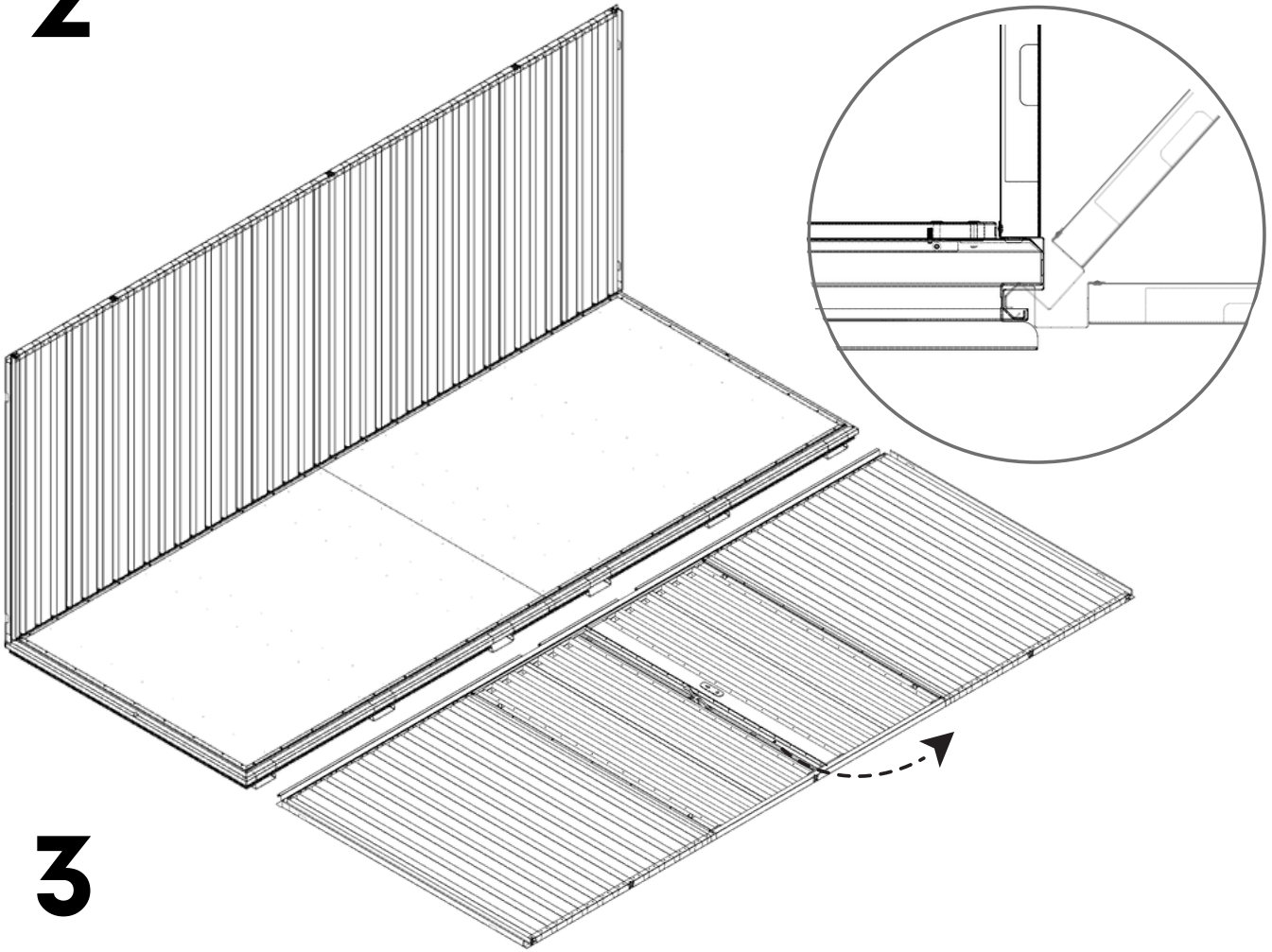

3

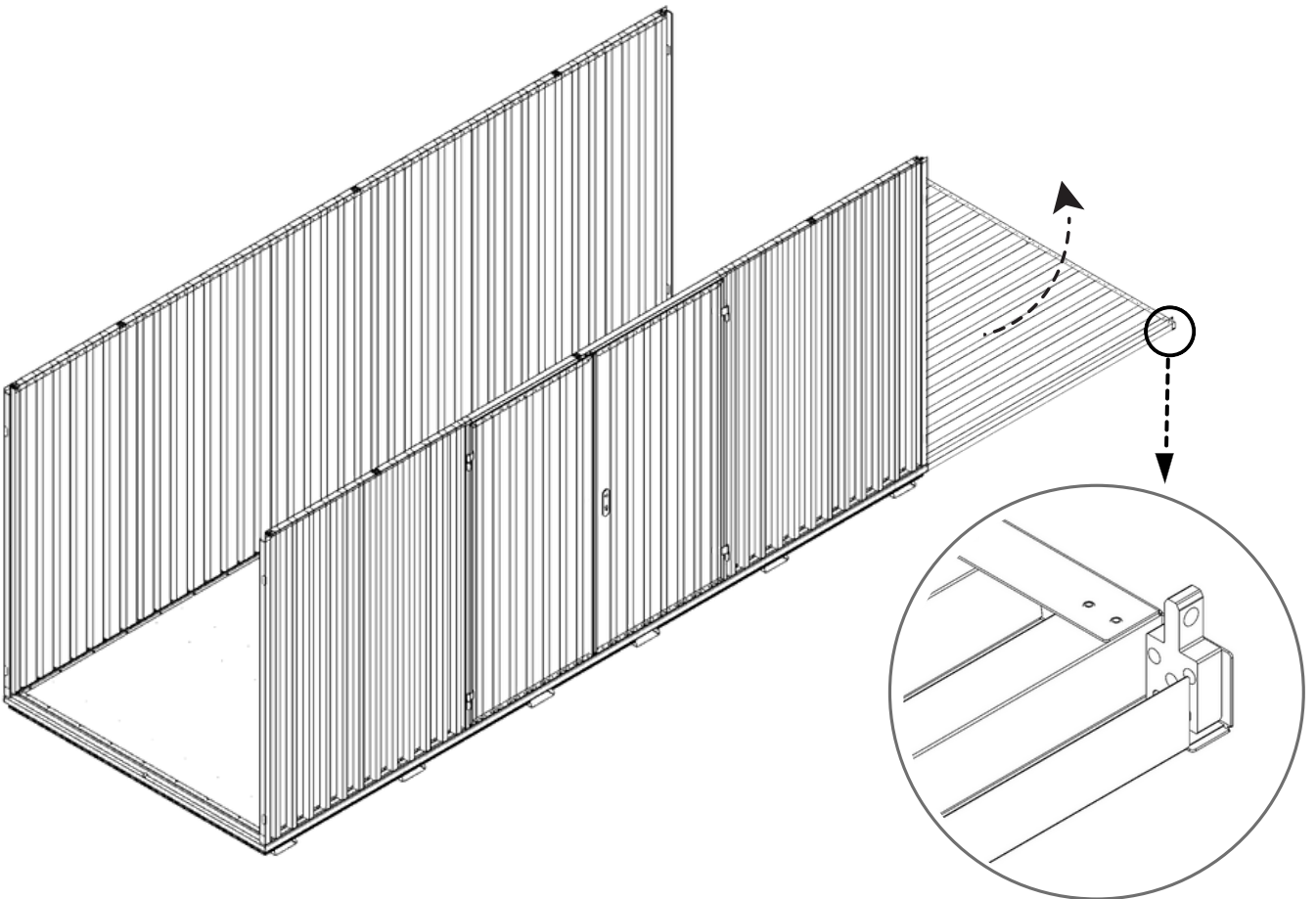

3.1

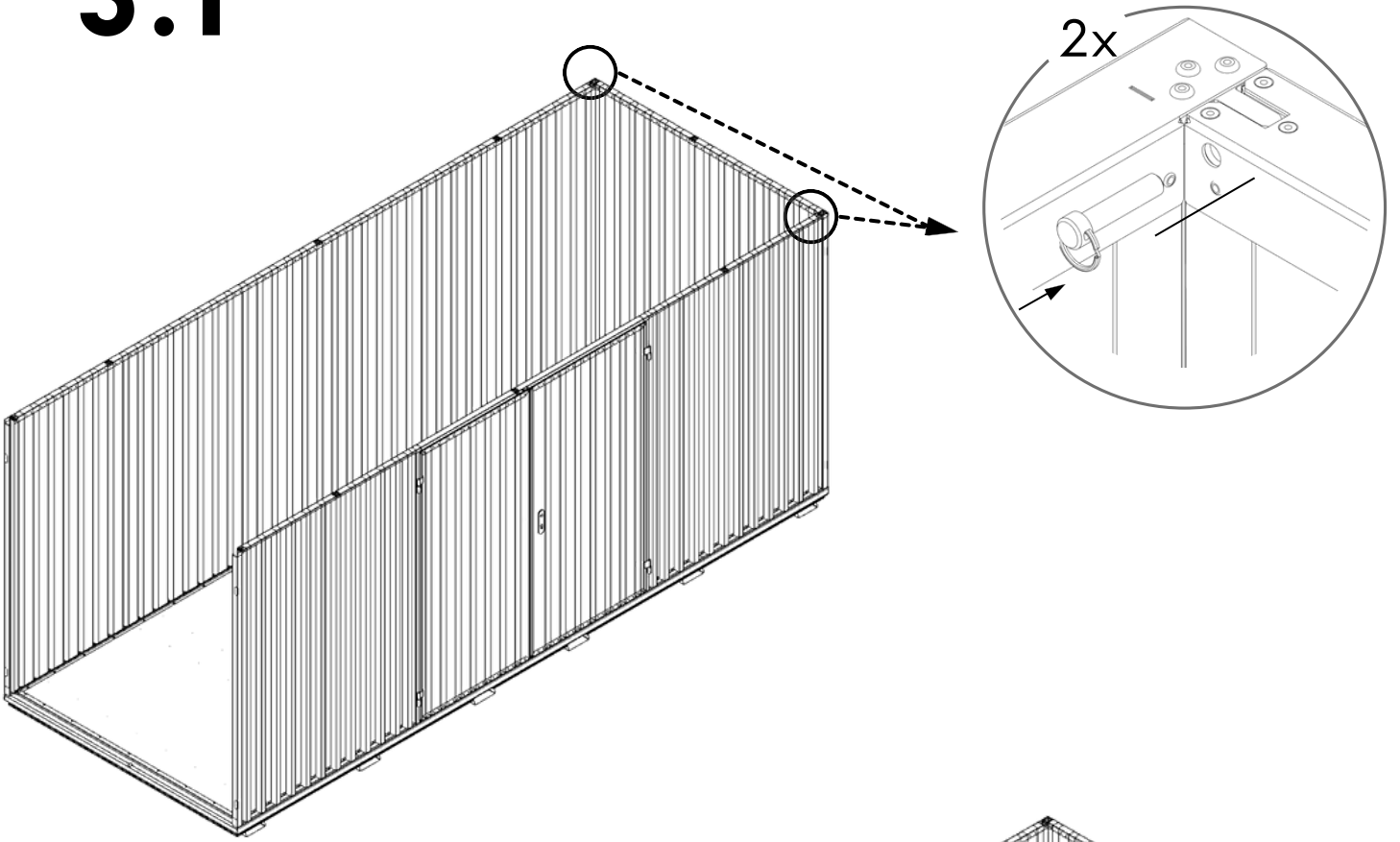



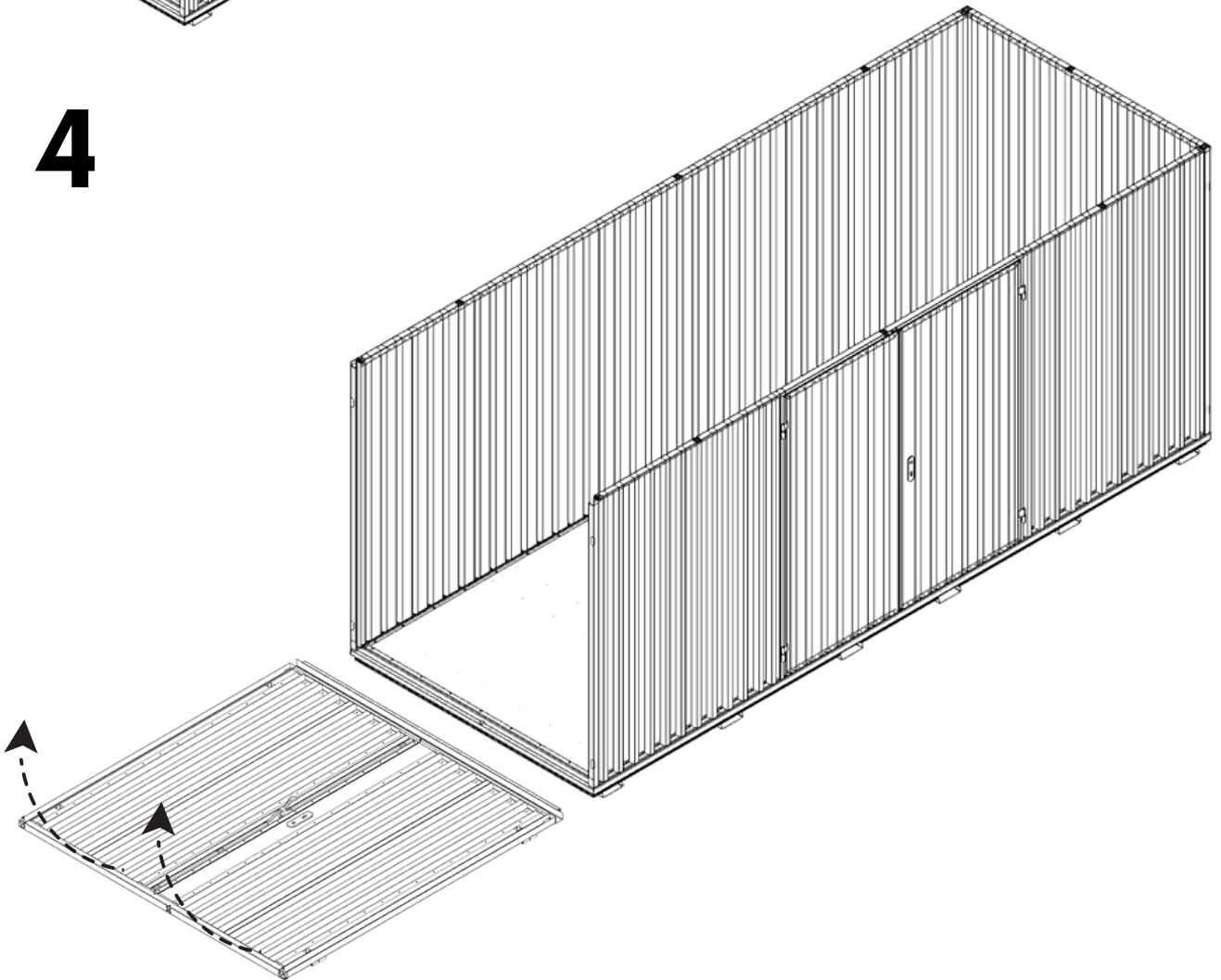



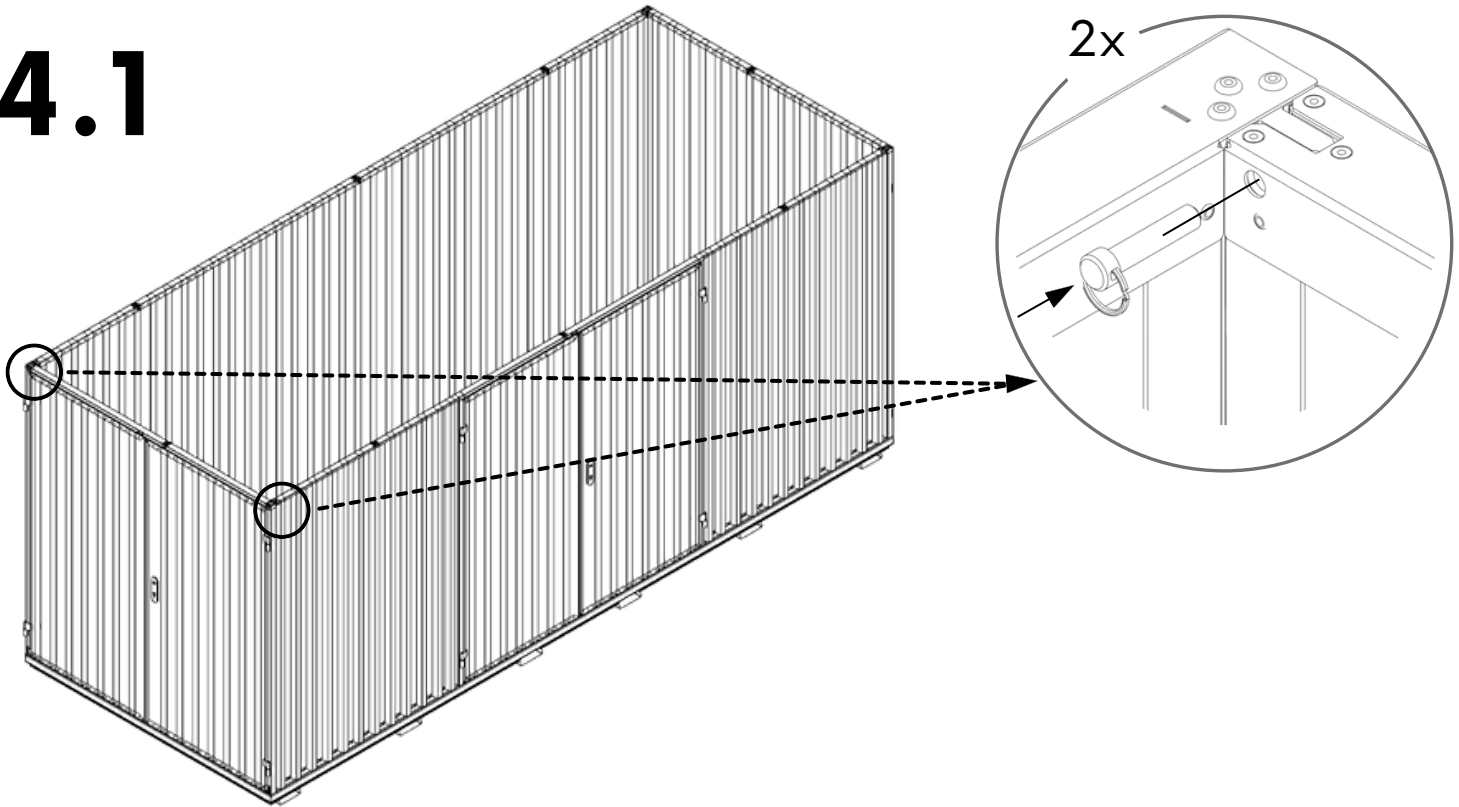

4



4.1



 527 KG	 1640 MM	Model Code: 50.110.430.330 Production Tracking Code:/X09.1.50.430.330    9001 14001 50001	 	
---	--	--	---	---

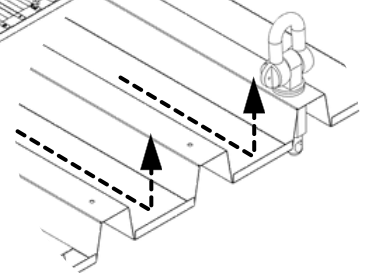
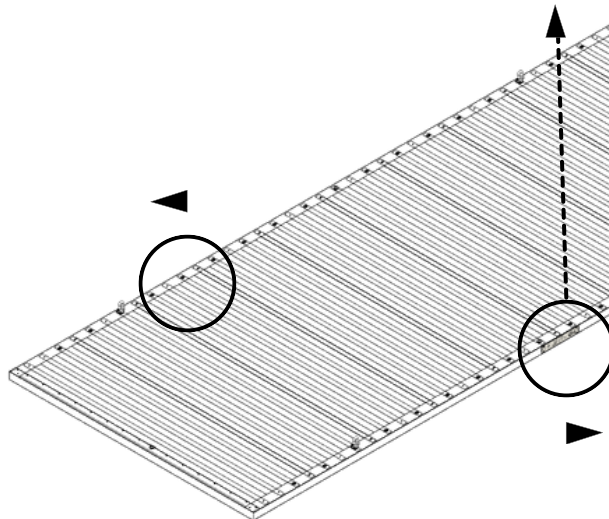
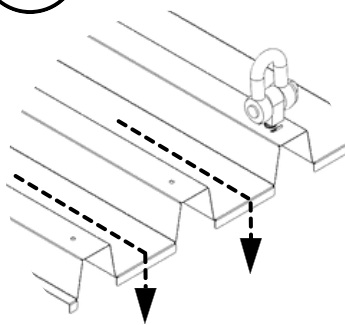

5

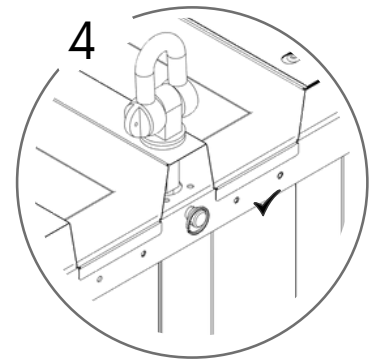
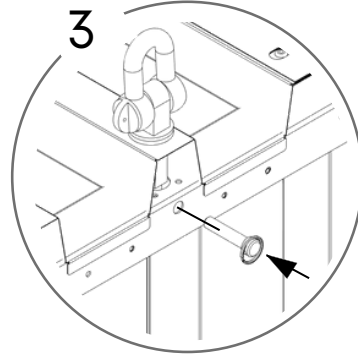
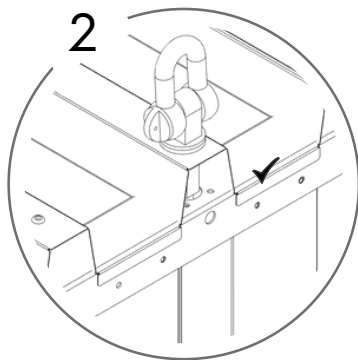
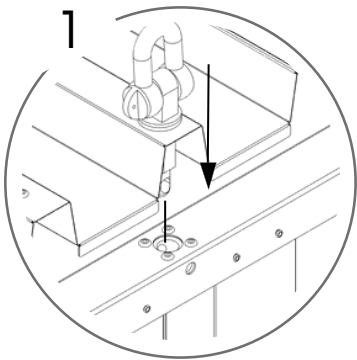
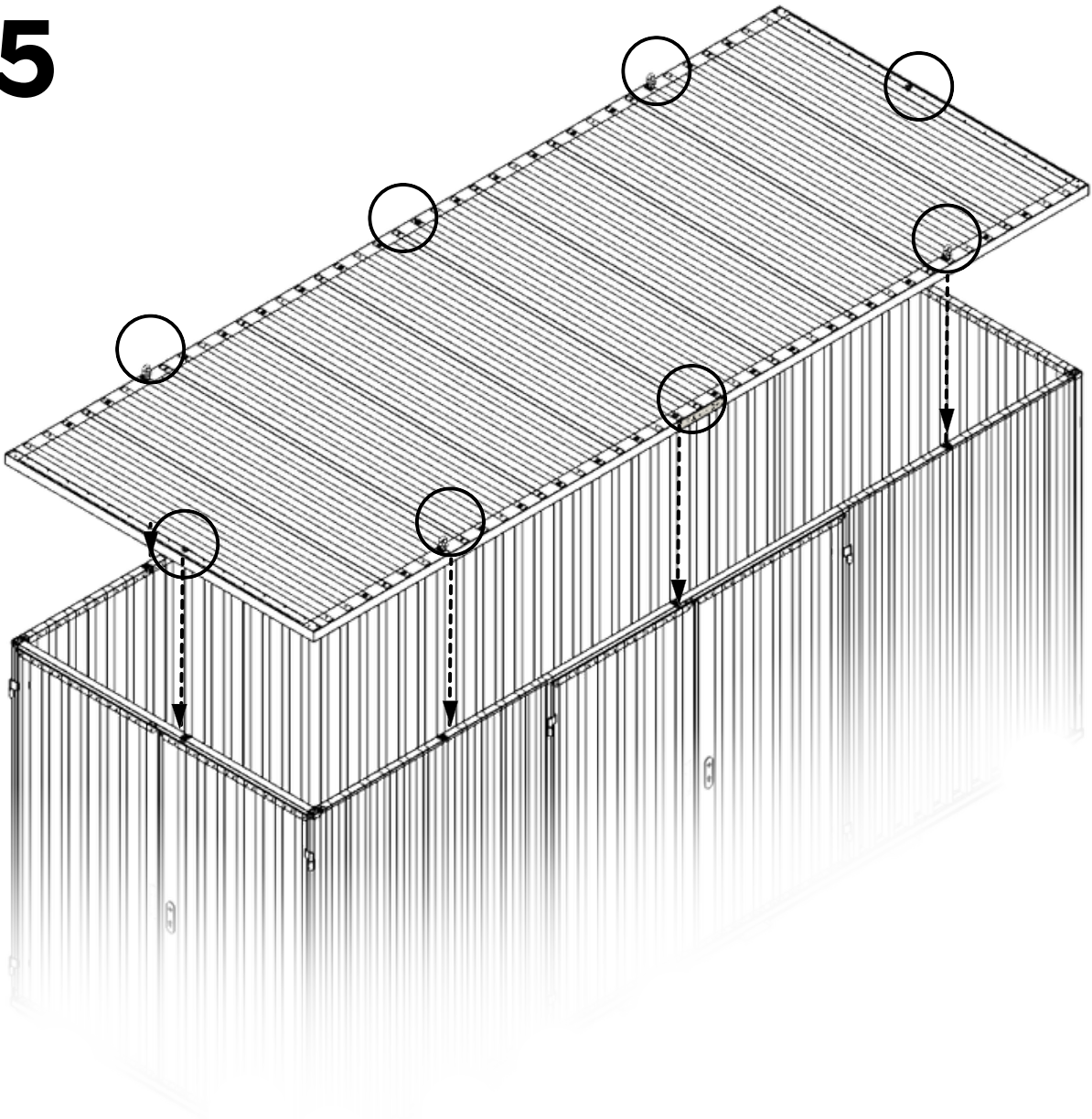

6

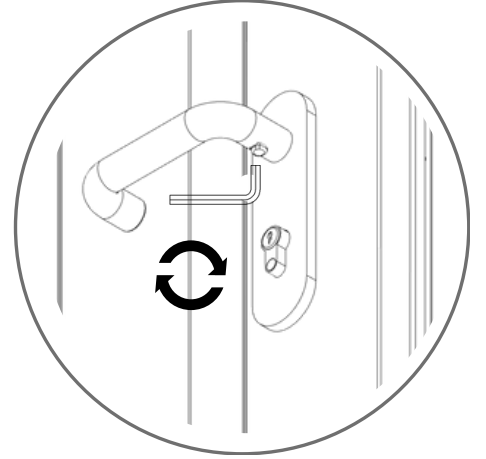
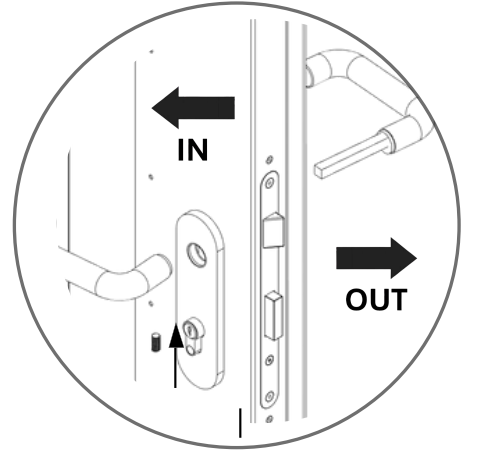
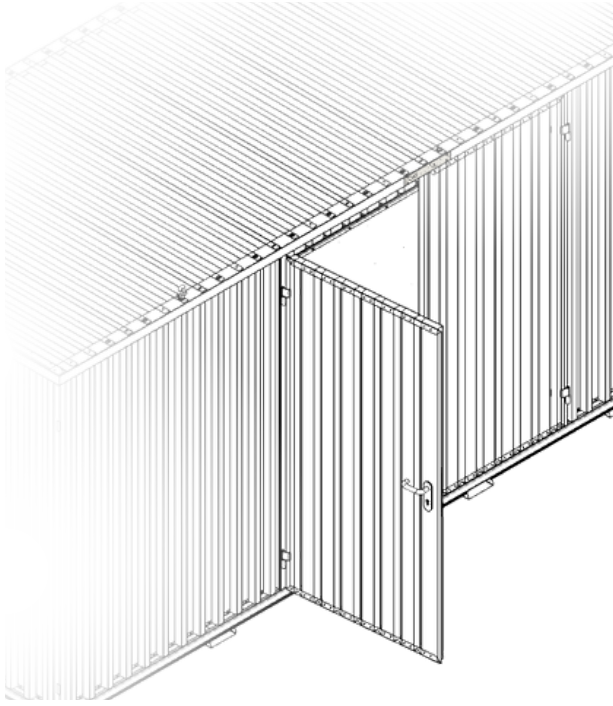

7

