

PRODUCT CODE:50.110.440.330

**prefabase**  
Quick Build Solutions

Instructions and User Guide

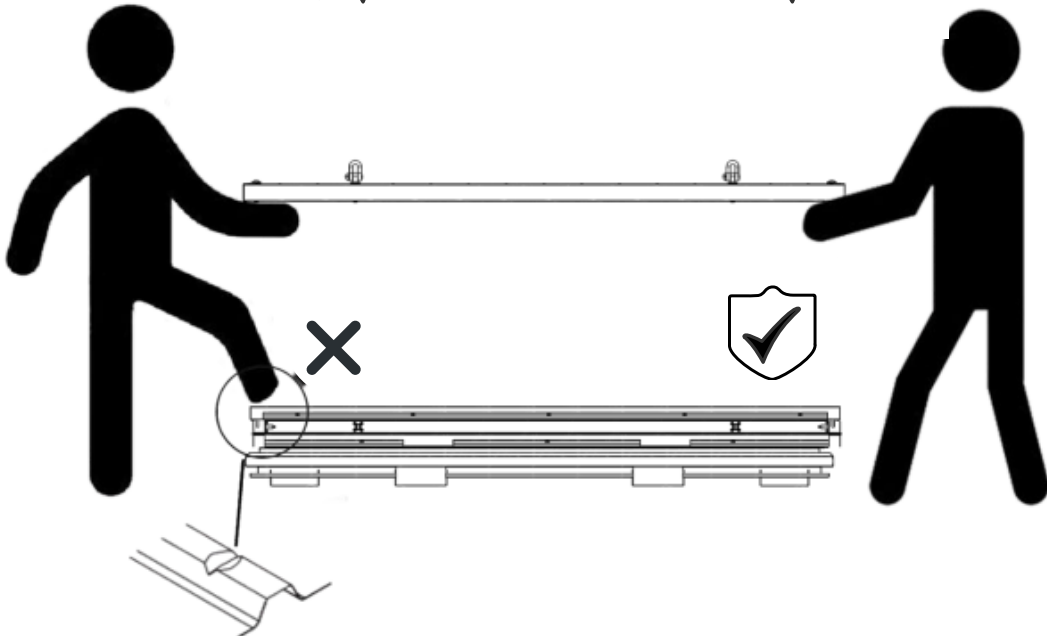
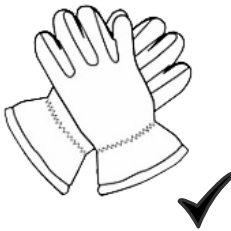

50.0110  
1x

50.0510  
1x

50.0410  
1x

50.0440  
1x

0310  
1x

0330  
1x

61.101  
2x

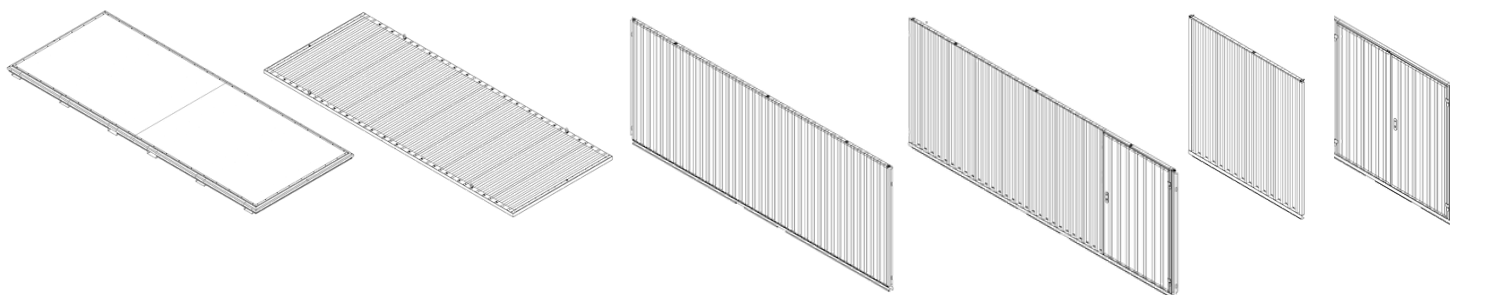

12x

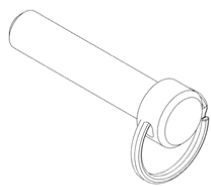

2x

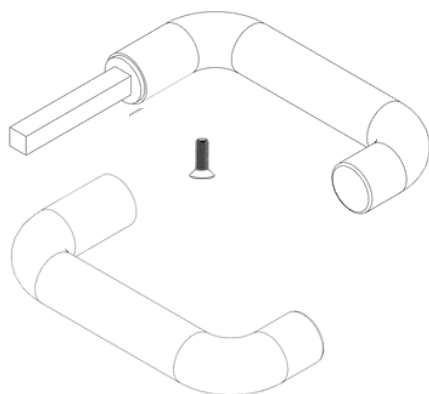

1x

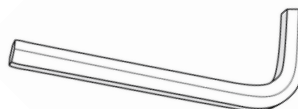

2x



# 1

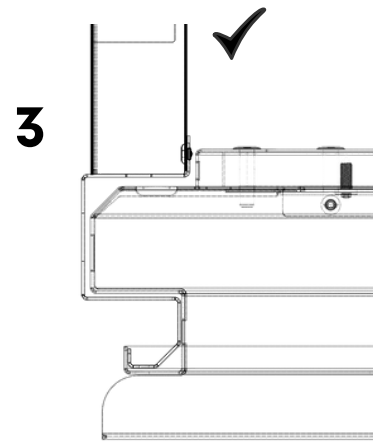
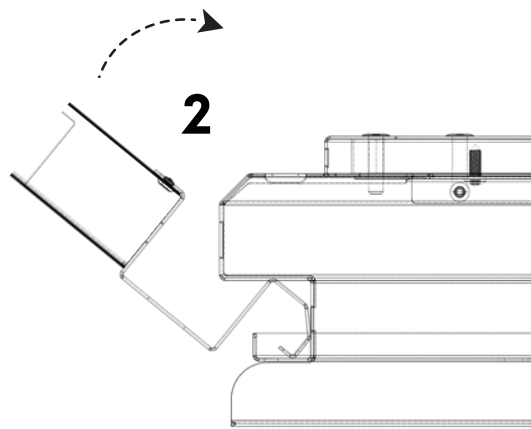
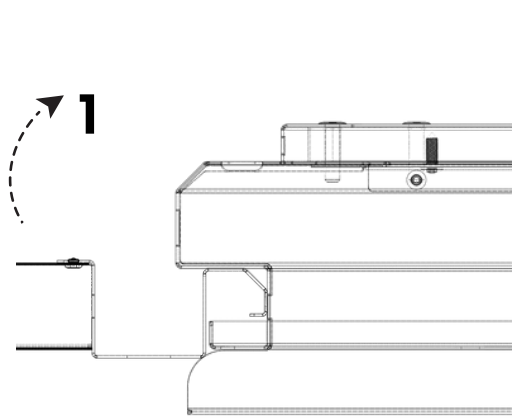
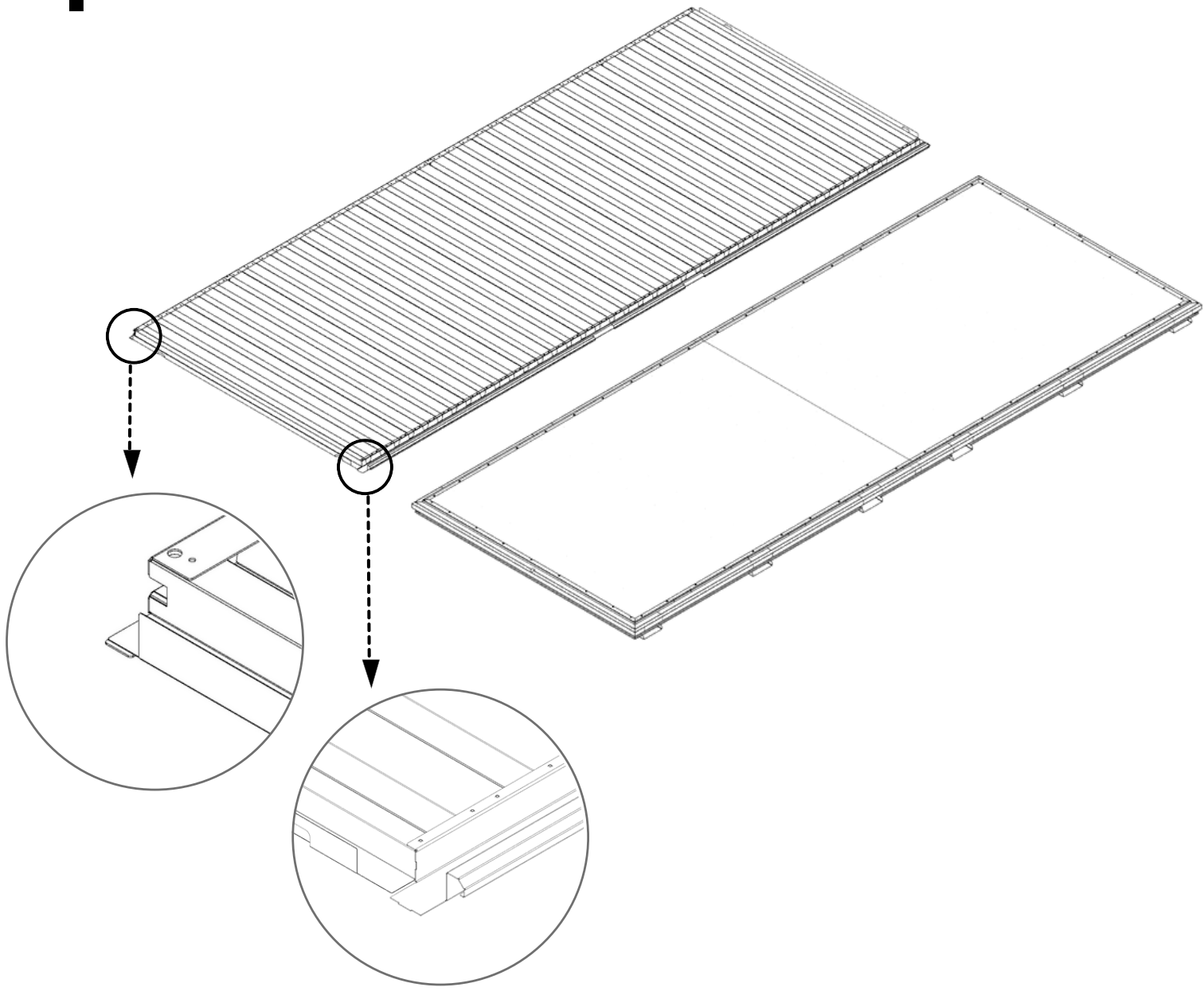

**2**

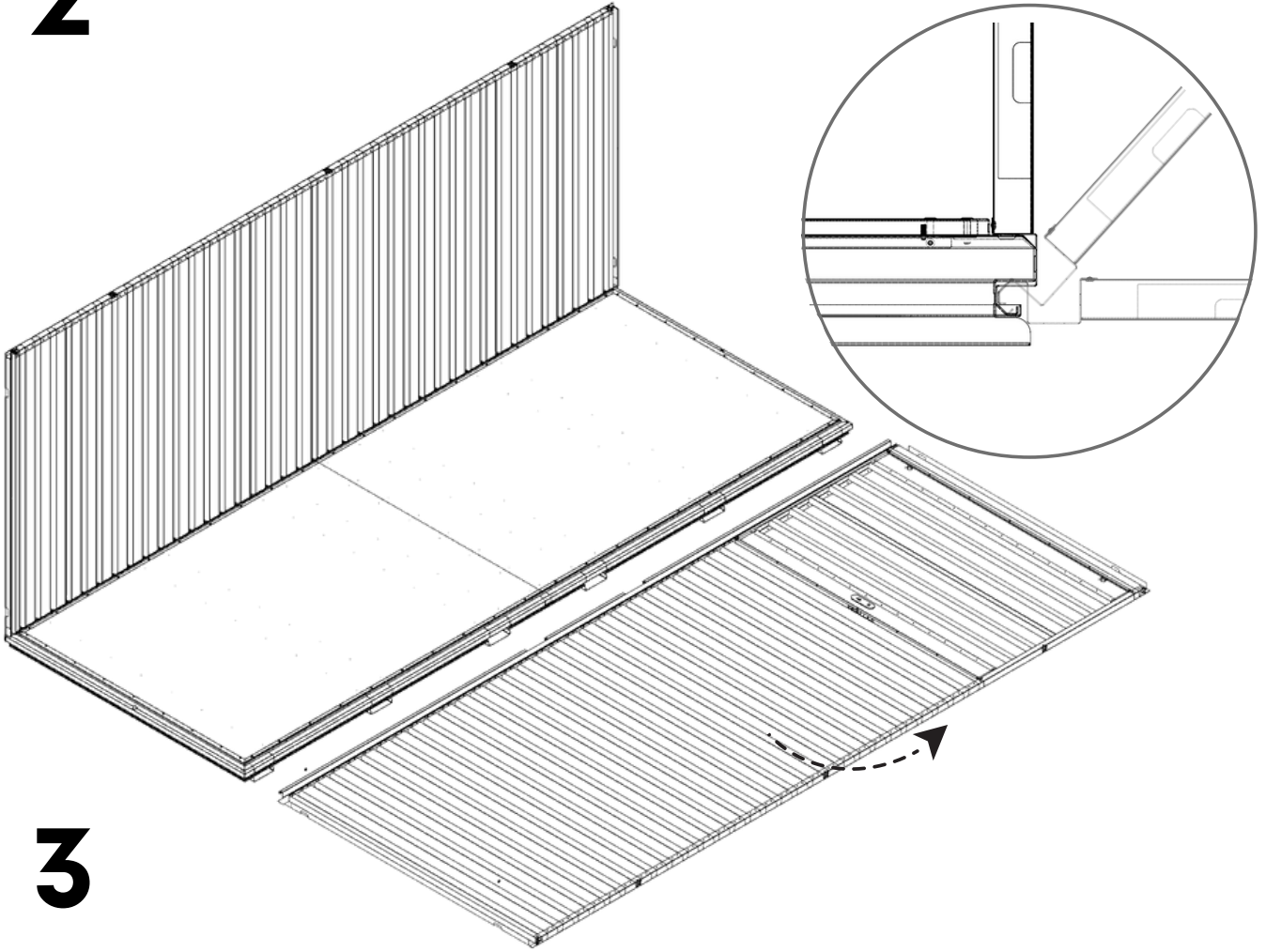

**3**

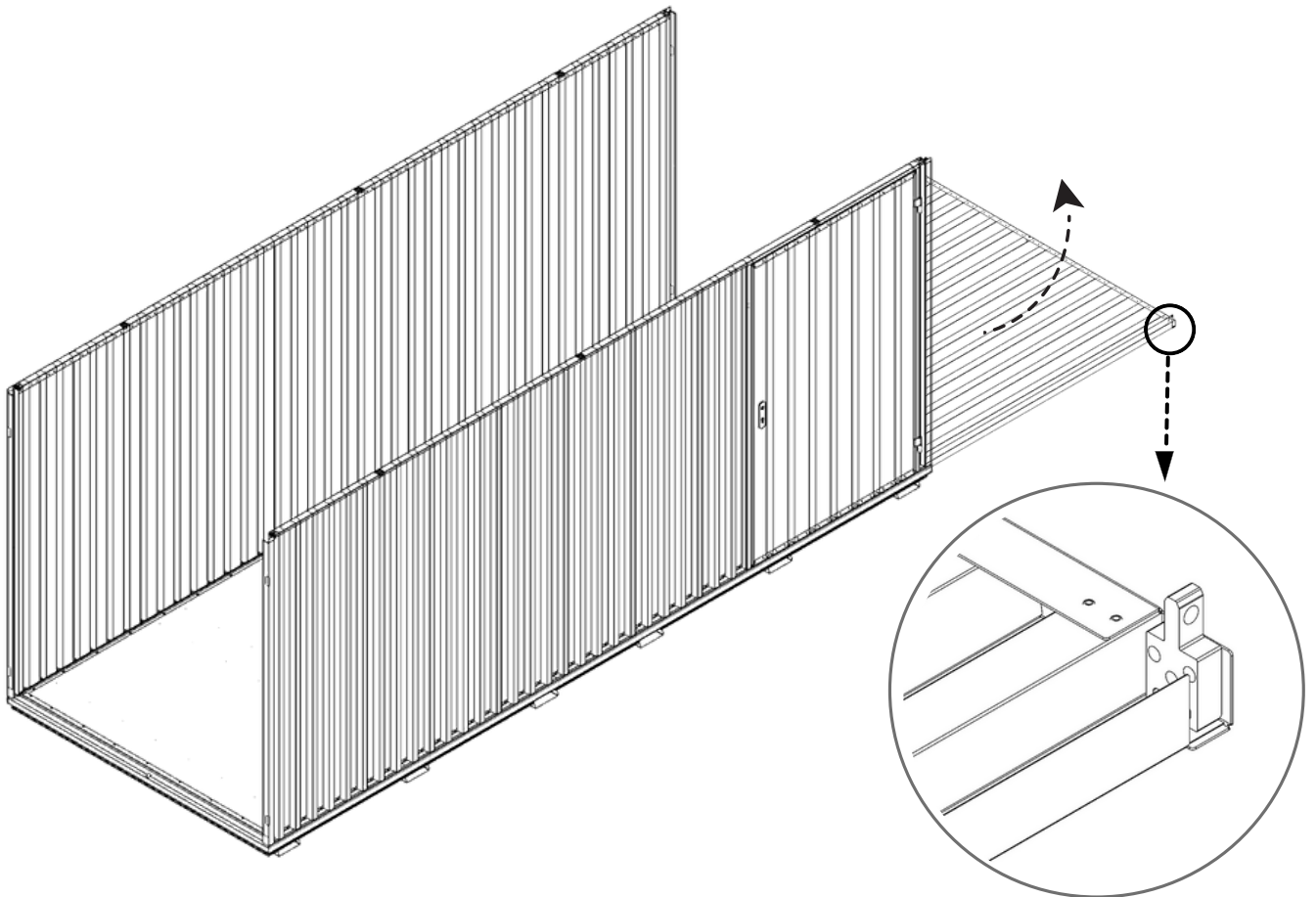

# 3.1

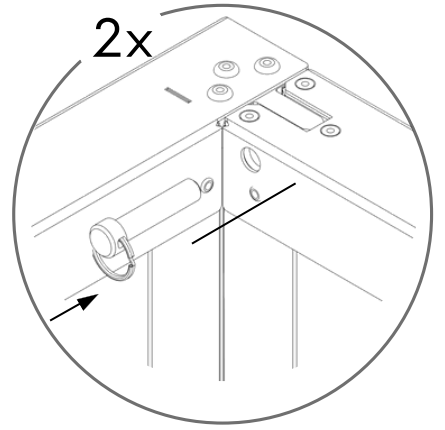
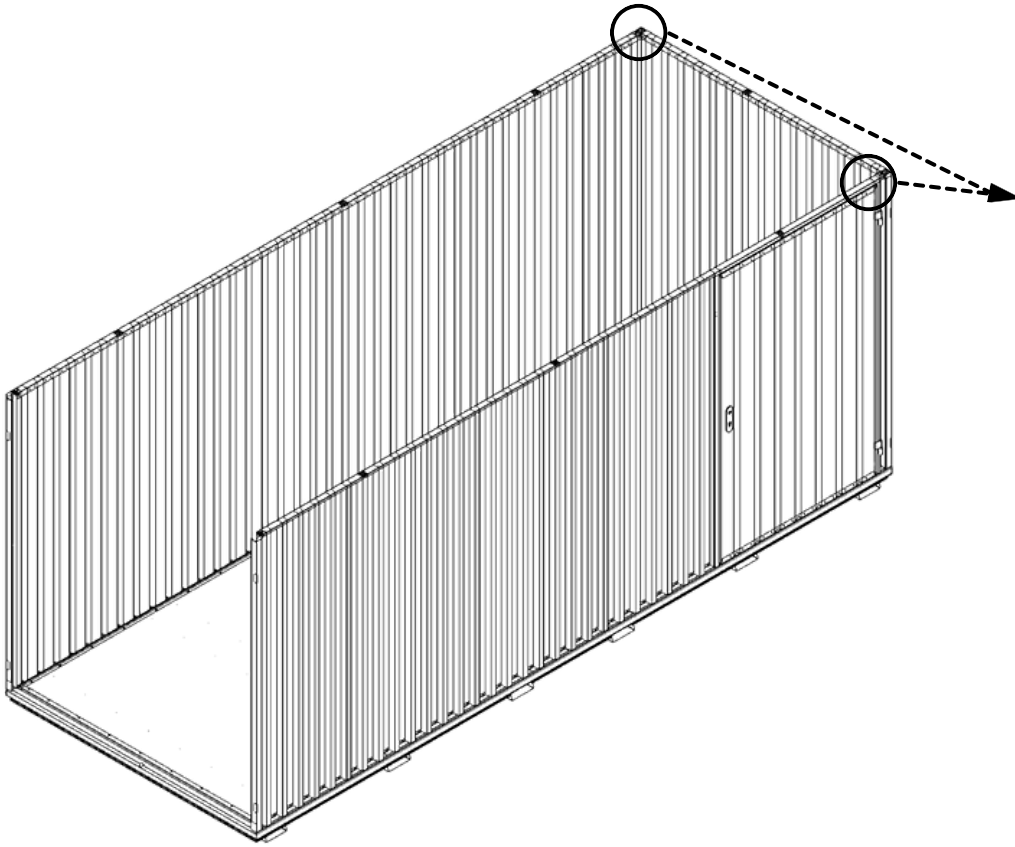



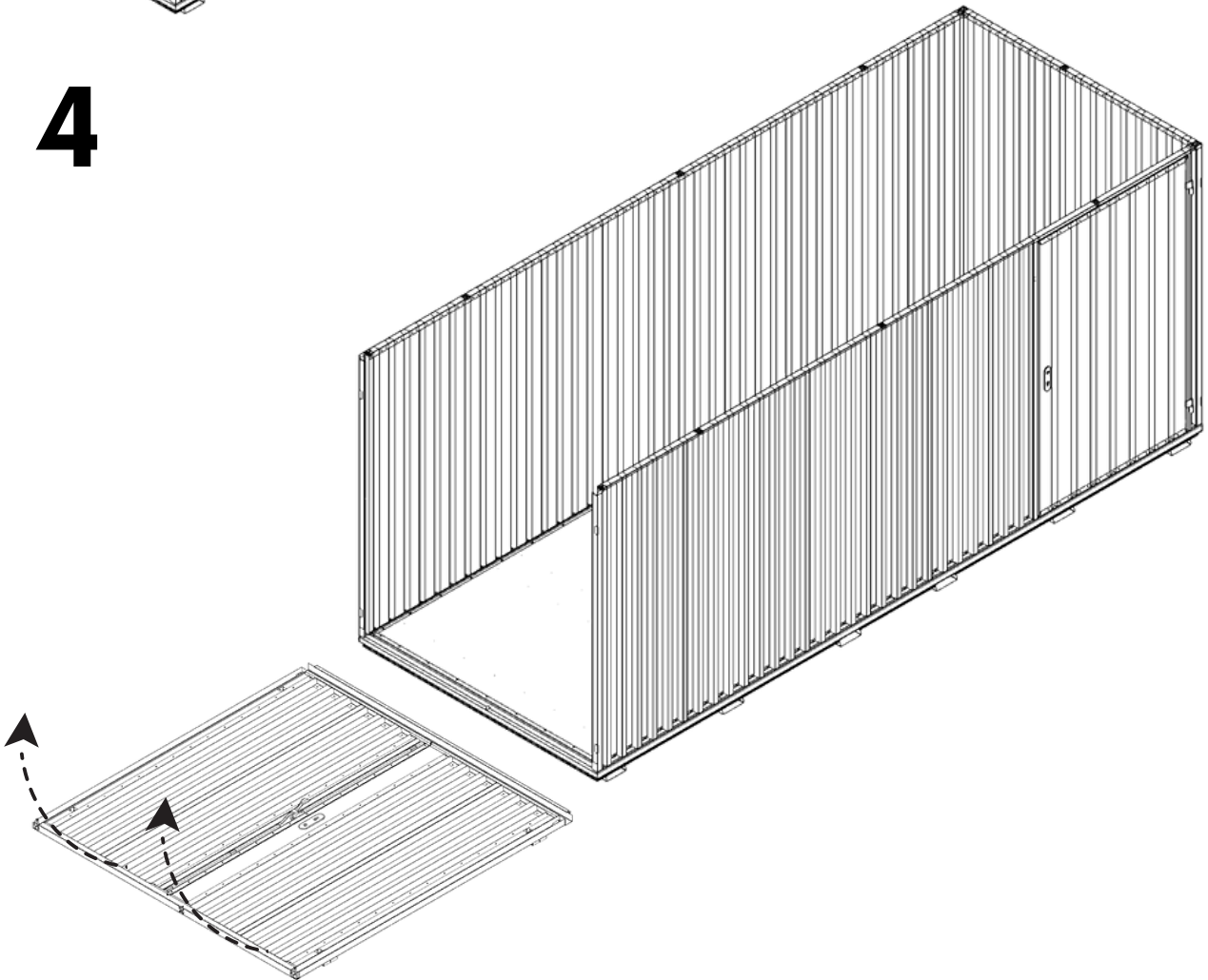



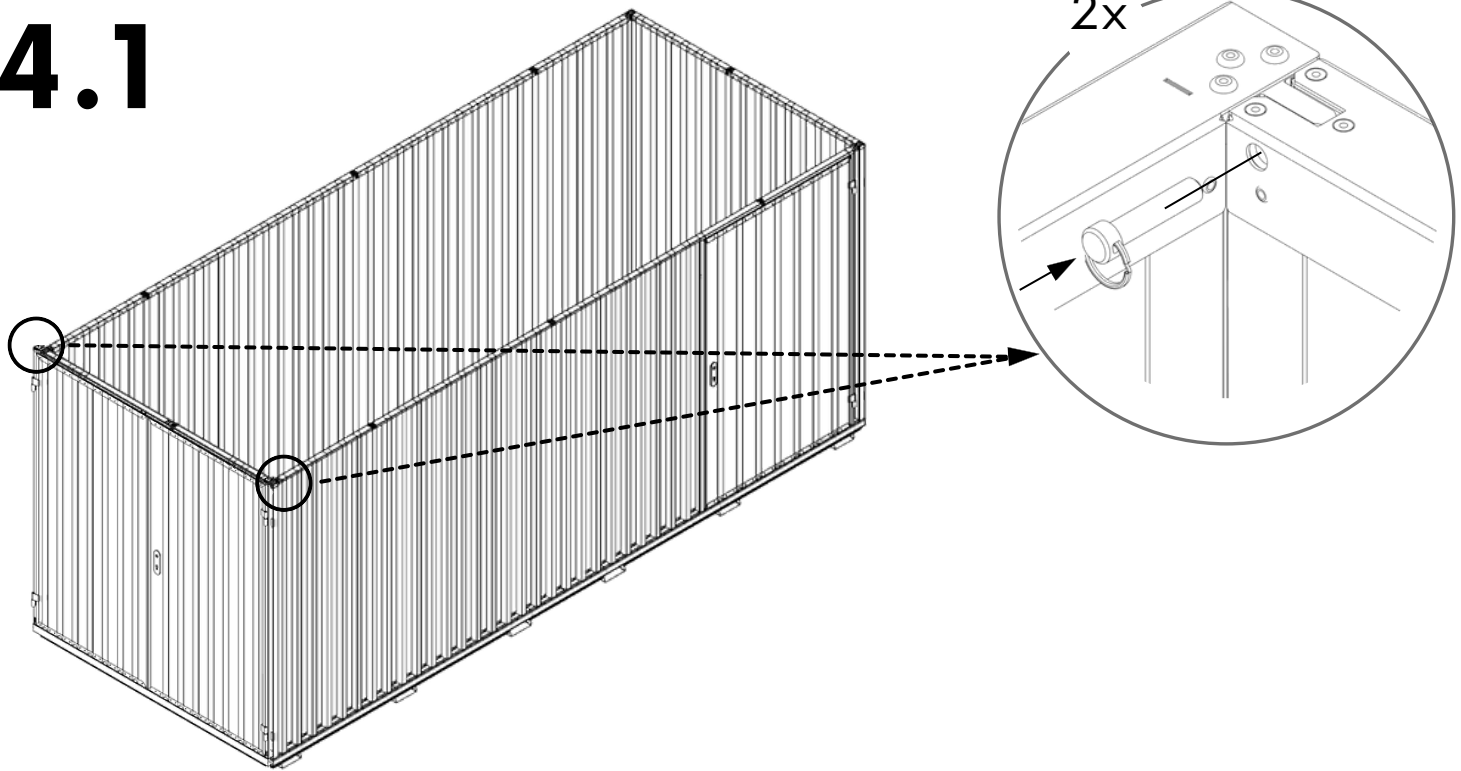

# 4



# 4.1



 512 KG	 1640 MM	Model Code: 50.110.440.330 Production Tracking Code: ...../X09.1.50.440.330    9001      14001      50001	 	
---	--	--	---	---

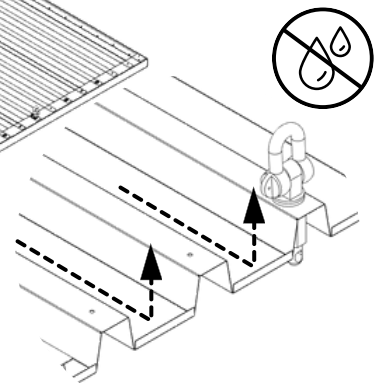
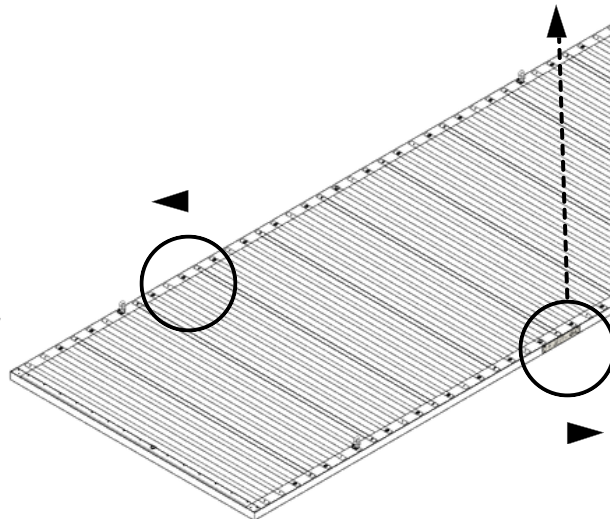
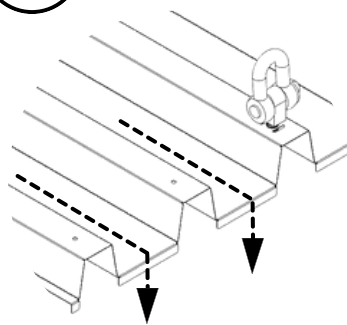

# 5

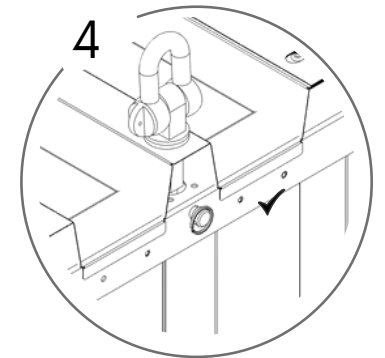
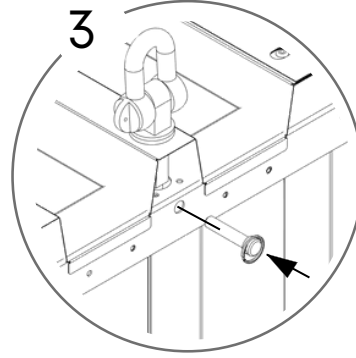
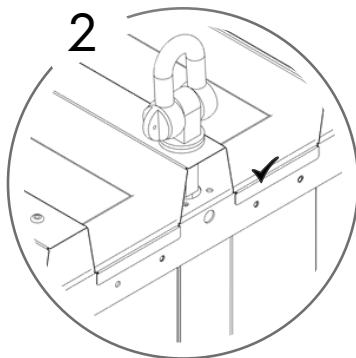
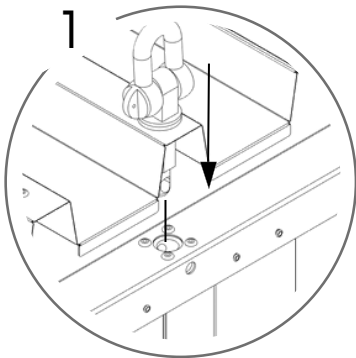
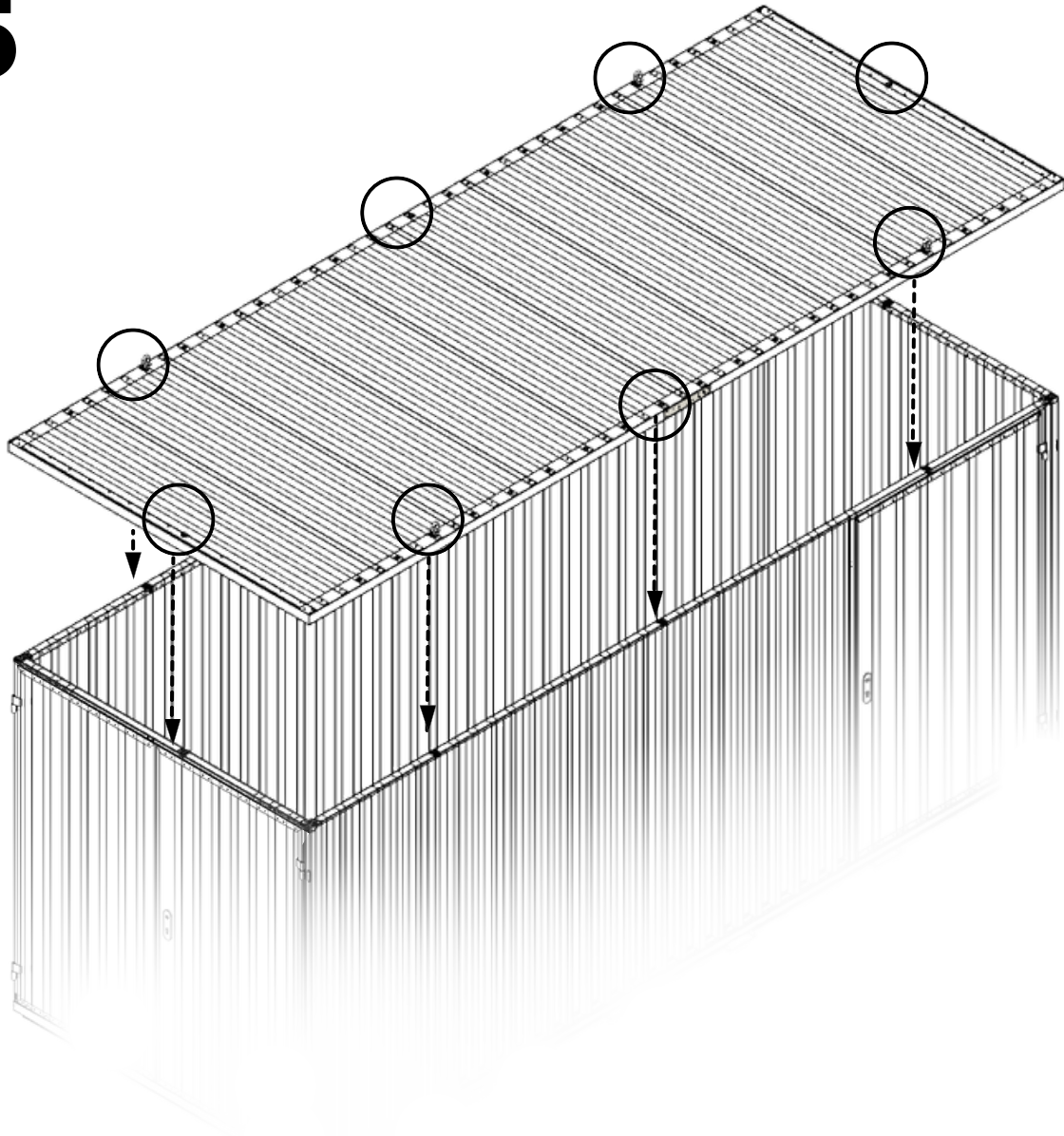

6

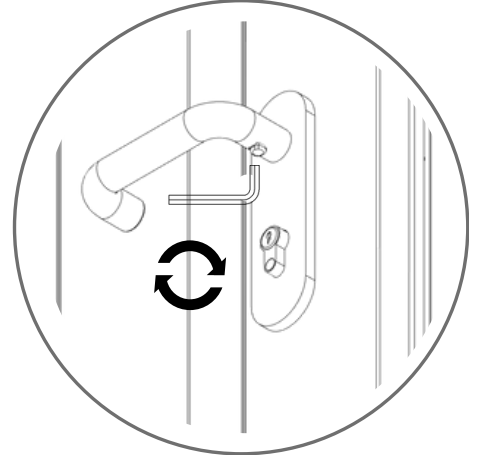
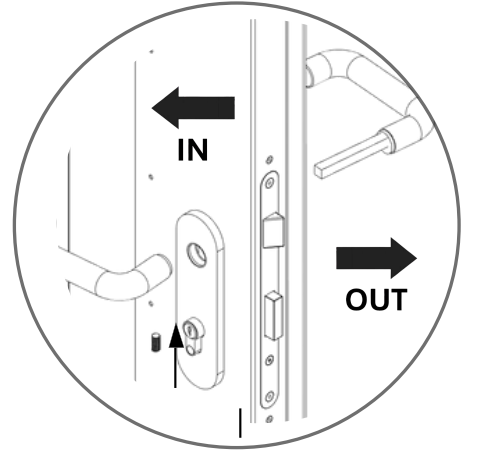

7

