

PRODUCT CODE: 20.110.320

prefabase
Quick Build Solutions

Instructions and User Guide

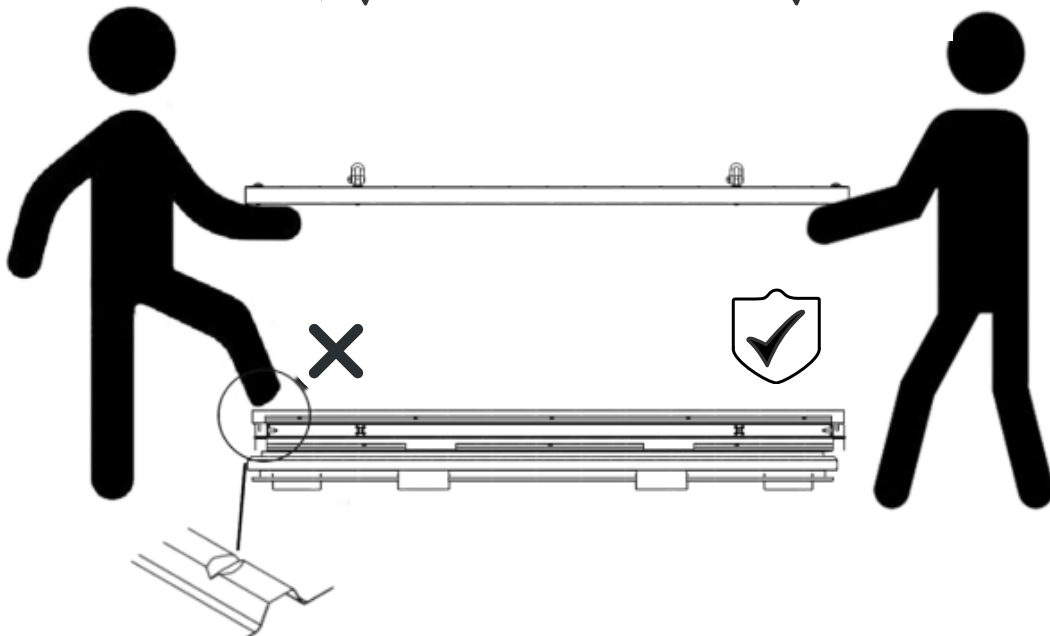
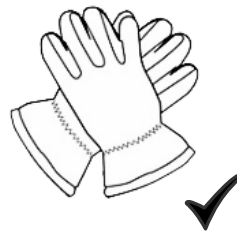

20.0110
1x

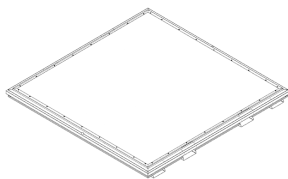

20.0510
1x

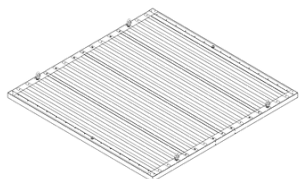

20.0410
2x

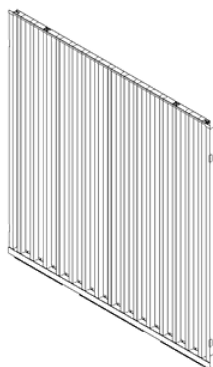

0310
1x

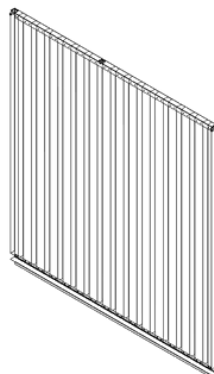

0320
1x

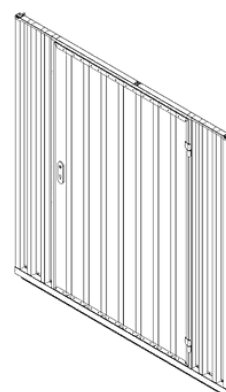

61.101
4x



10x

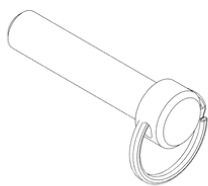

1x

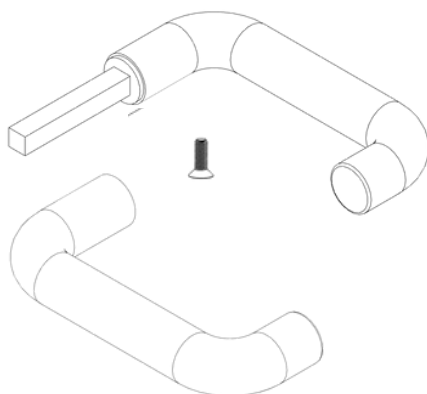

1x

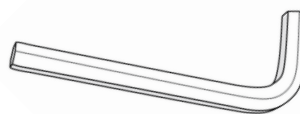

1x



1

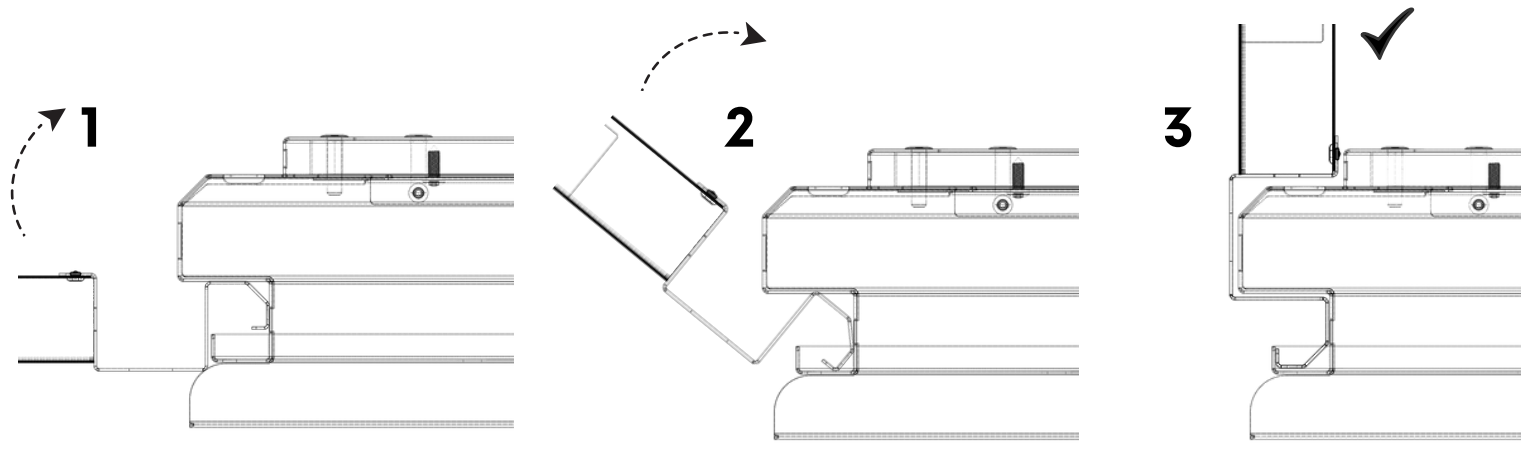
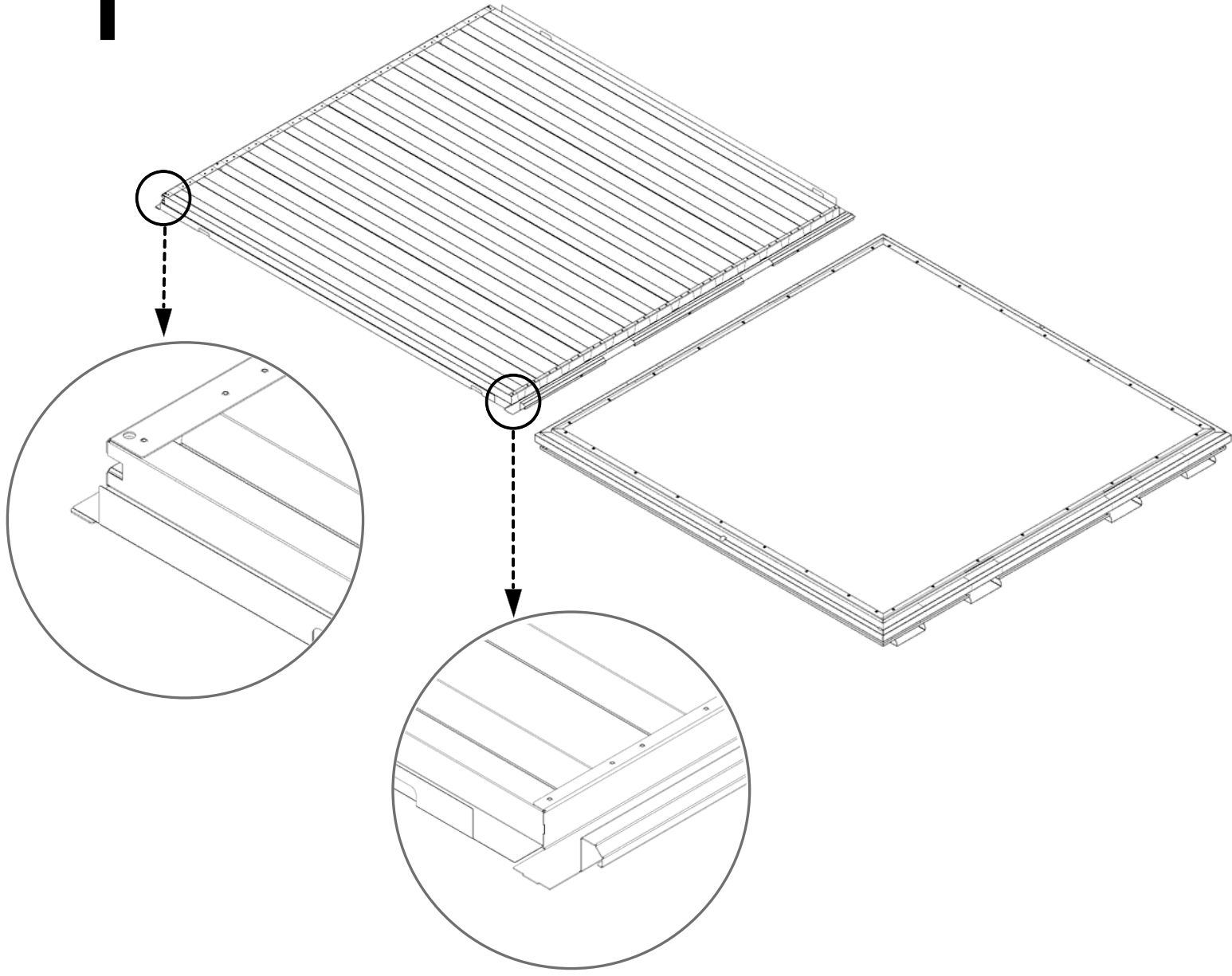

2

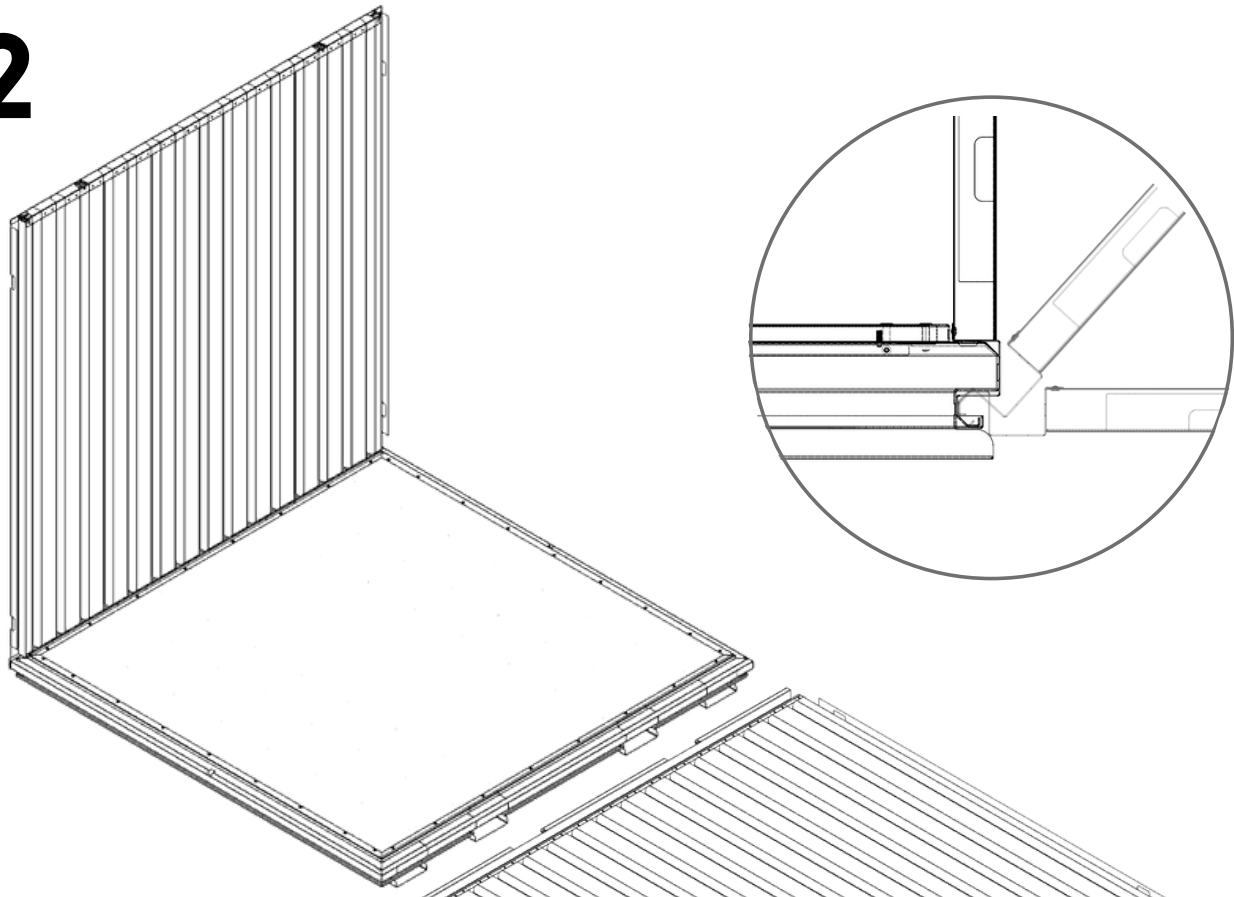

3

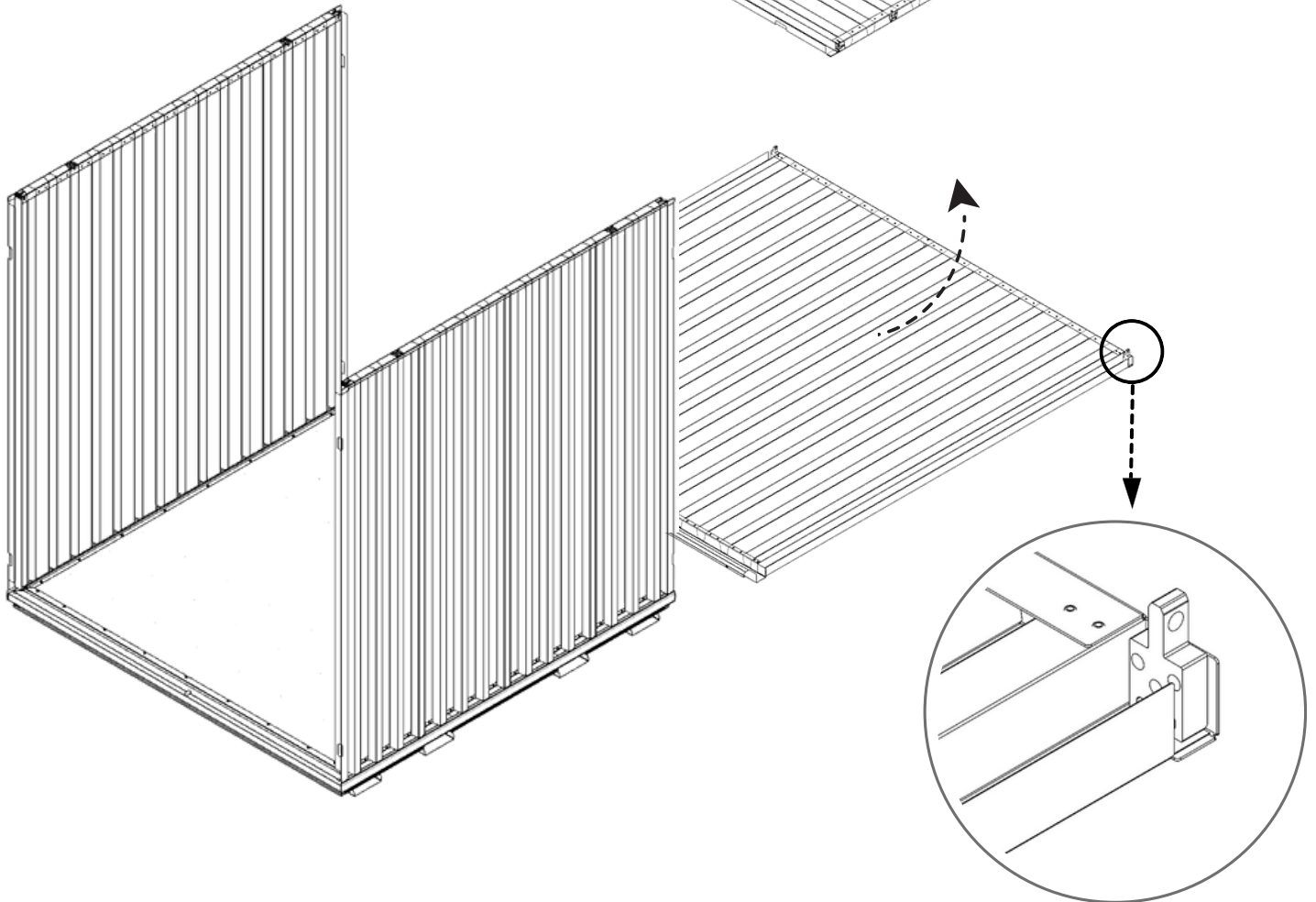

3.1

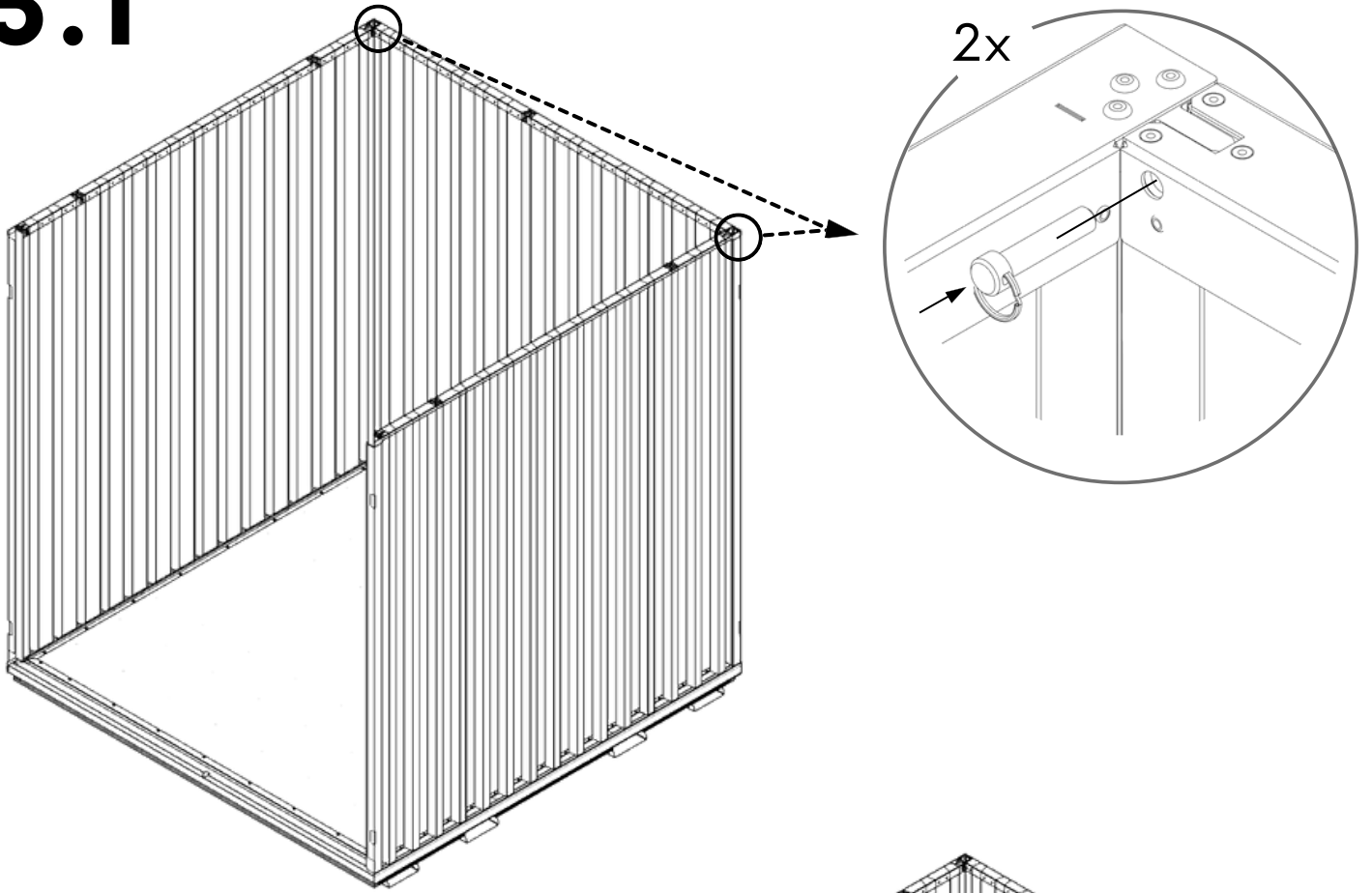



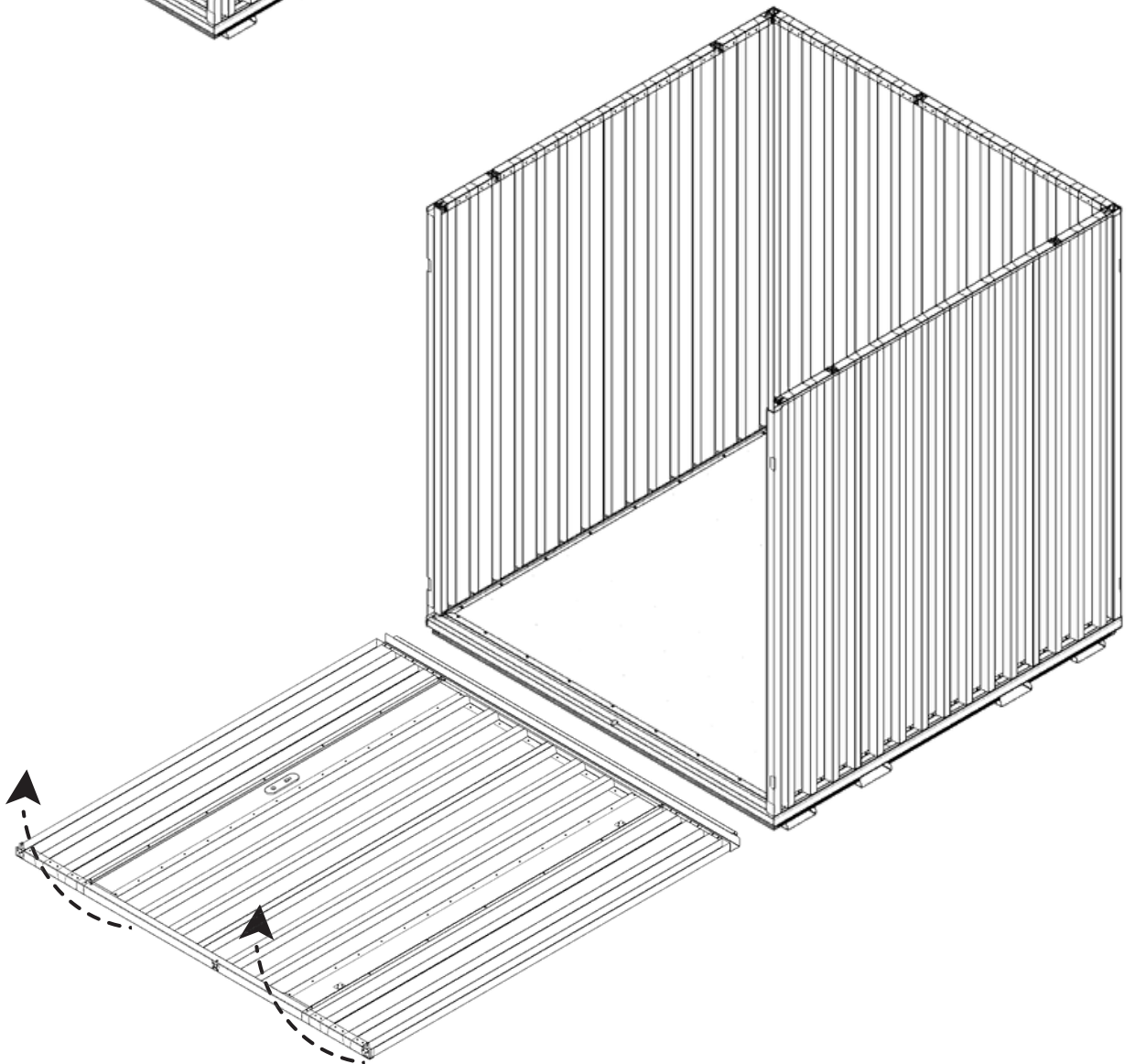



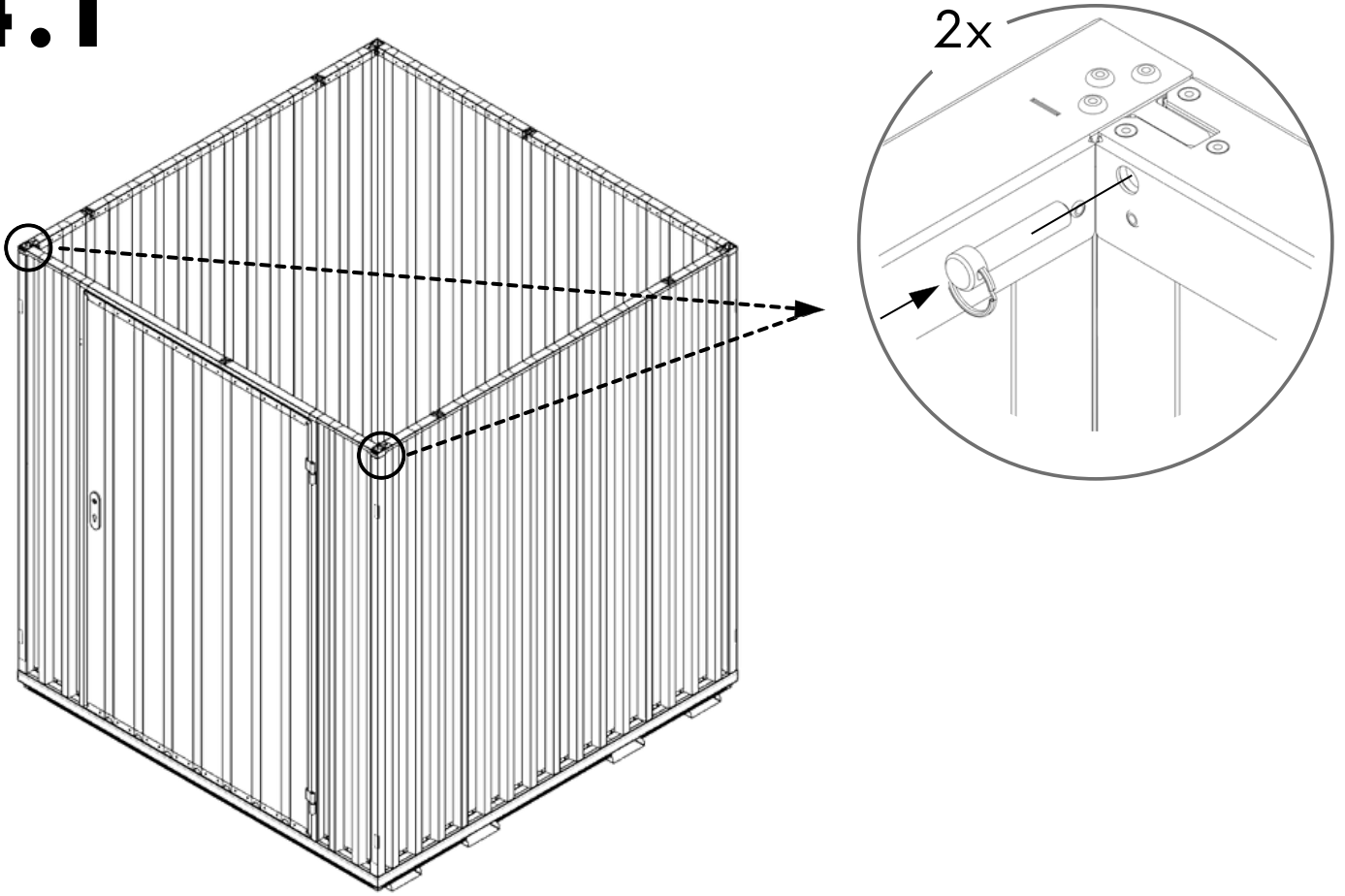

4



4.1



 265 KG	 1640 MM	Model Code: 20.110.320 Production Tracking Code: /X09.1.20.320    9001 14001 50001	 	
---	--	---	---	---

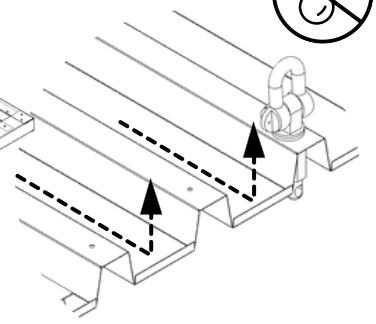
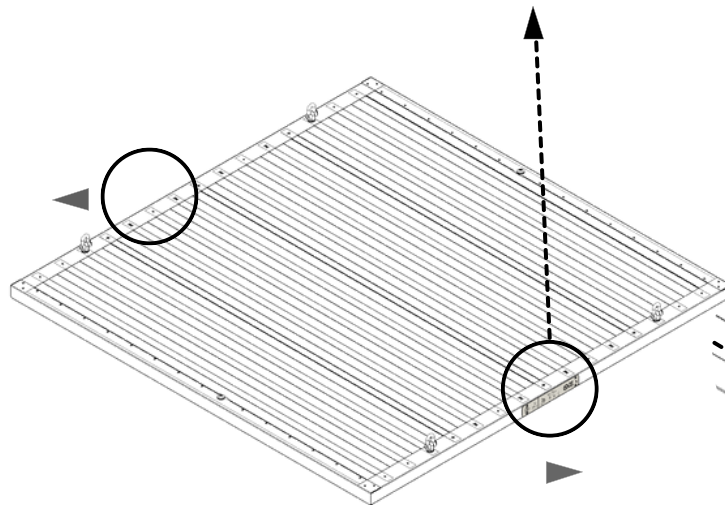
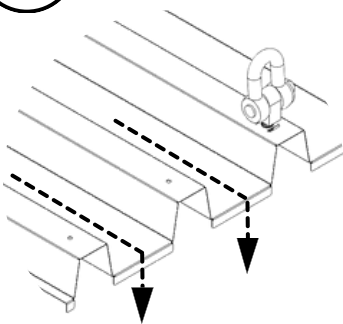

5

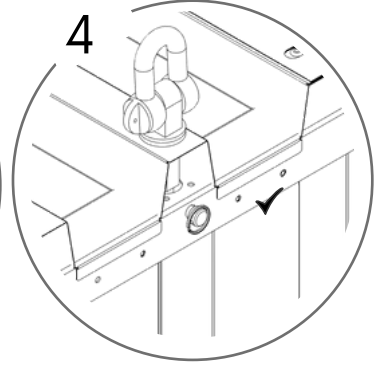
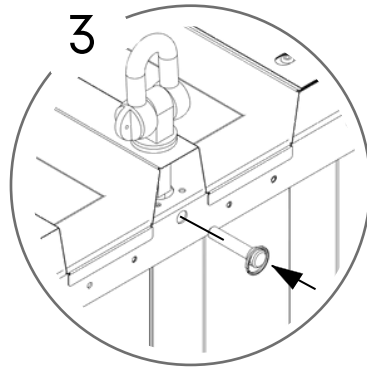
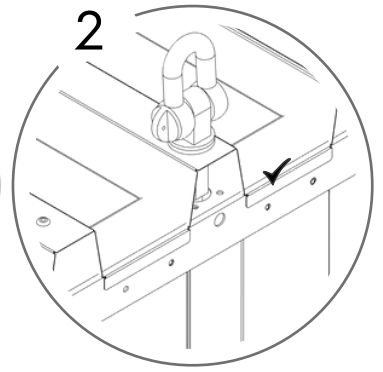
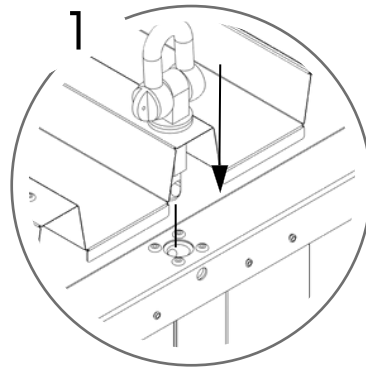
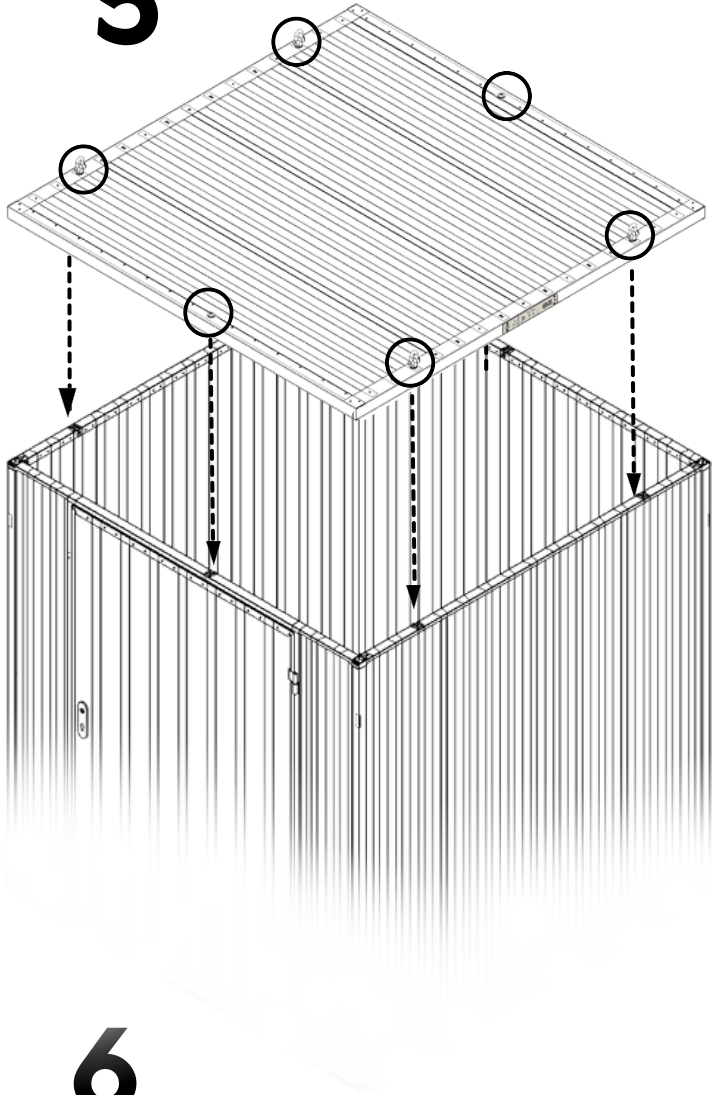

6

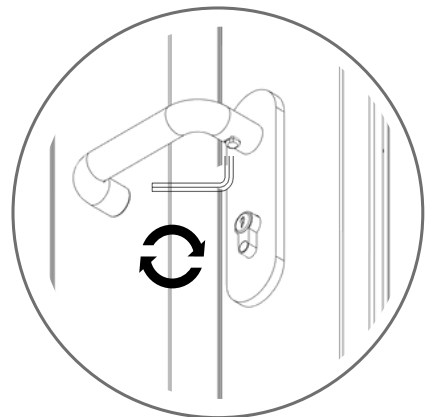
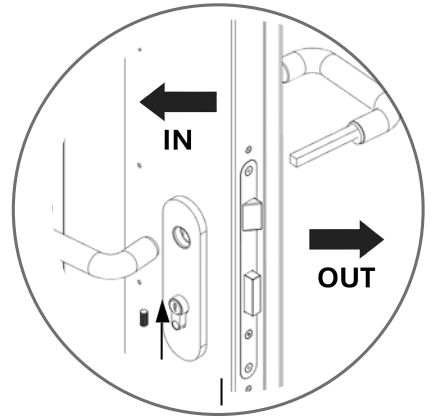
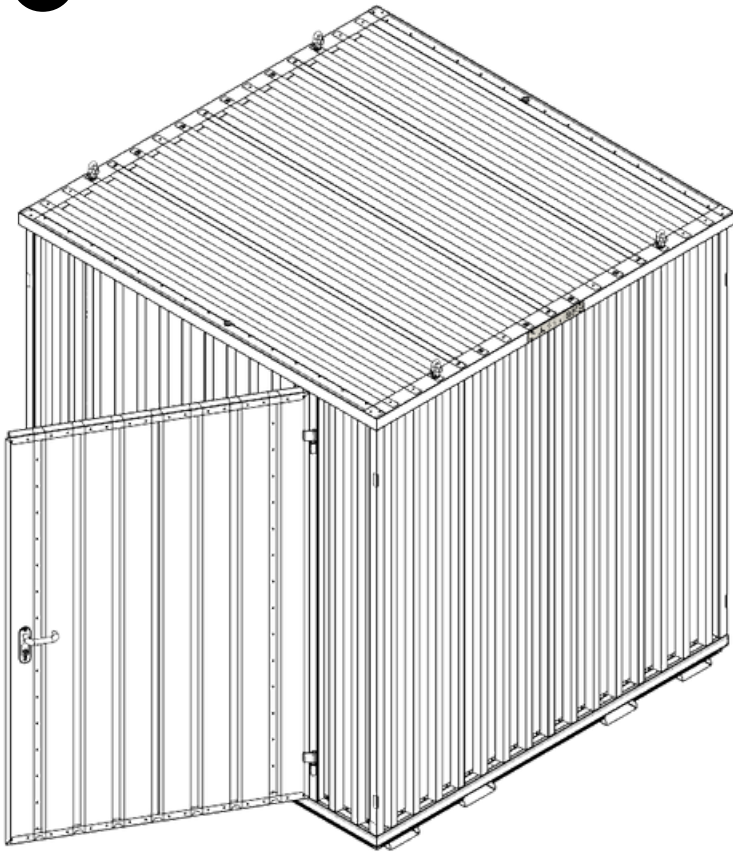

7

