

PRODUCT CODE:40.110.440.320

prefabase
Quick Build Solutions

Instructions and User Guide

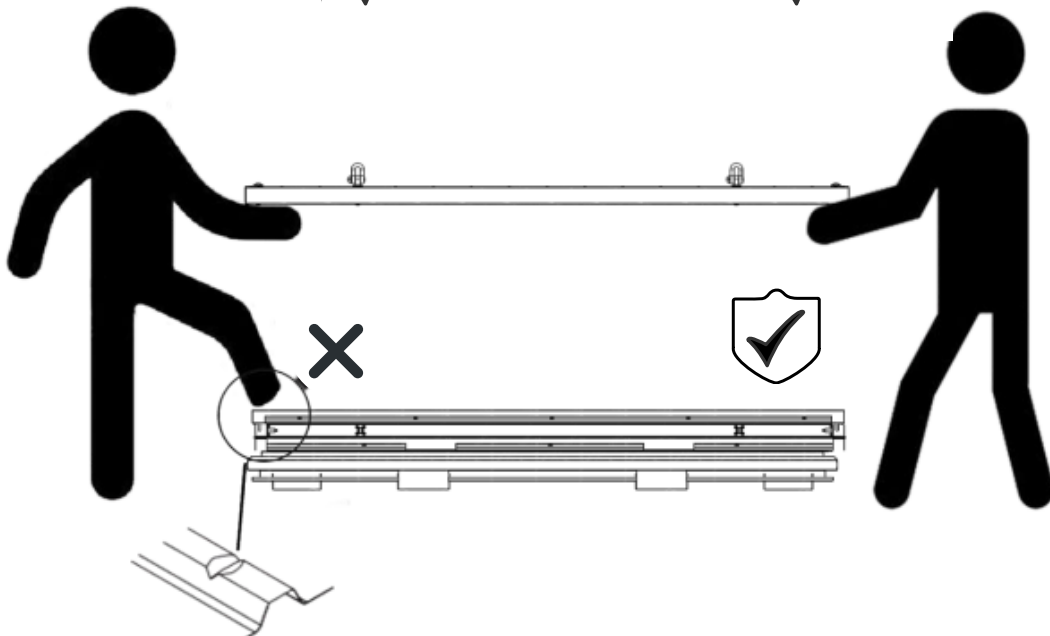
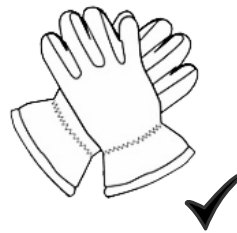

40.0110
1x

40.0510
1x

40.0410
1x

40.0440
1x

0310
1x

0320
1x

61.101
4x

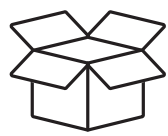
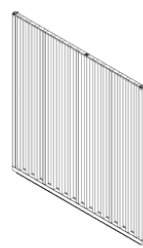
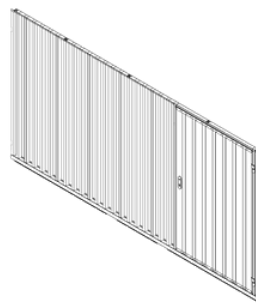
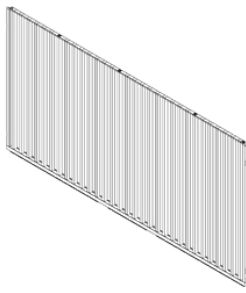
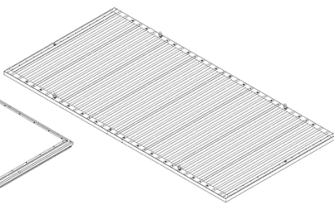
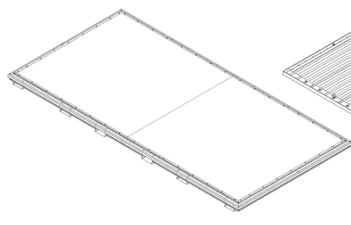

12x

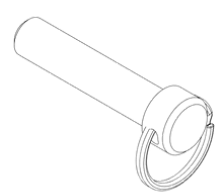

2x

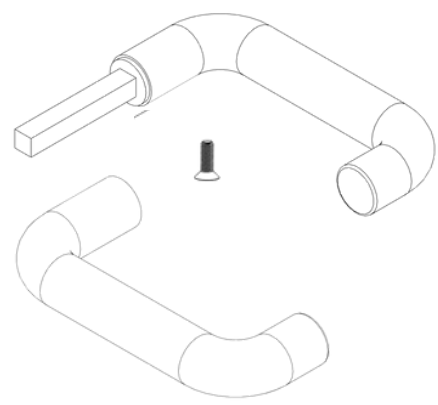

1x

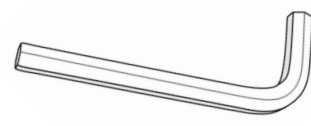

2x



1

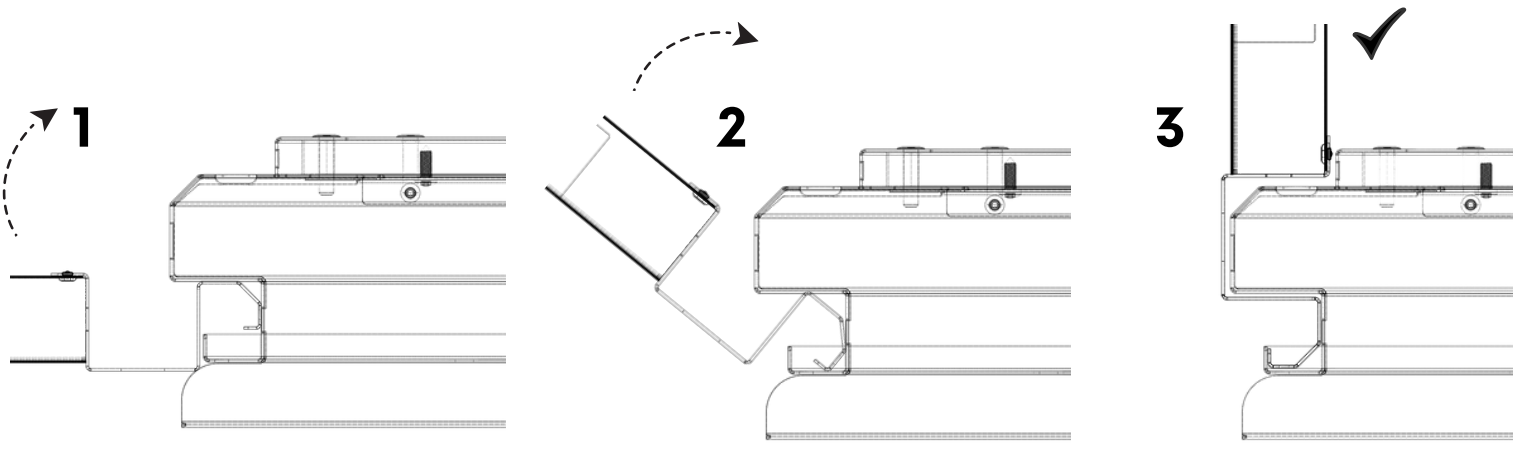
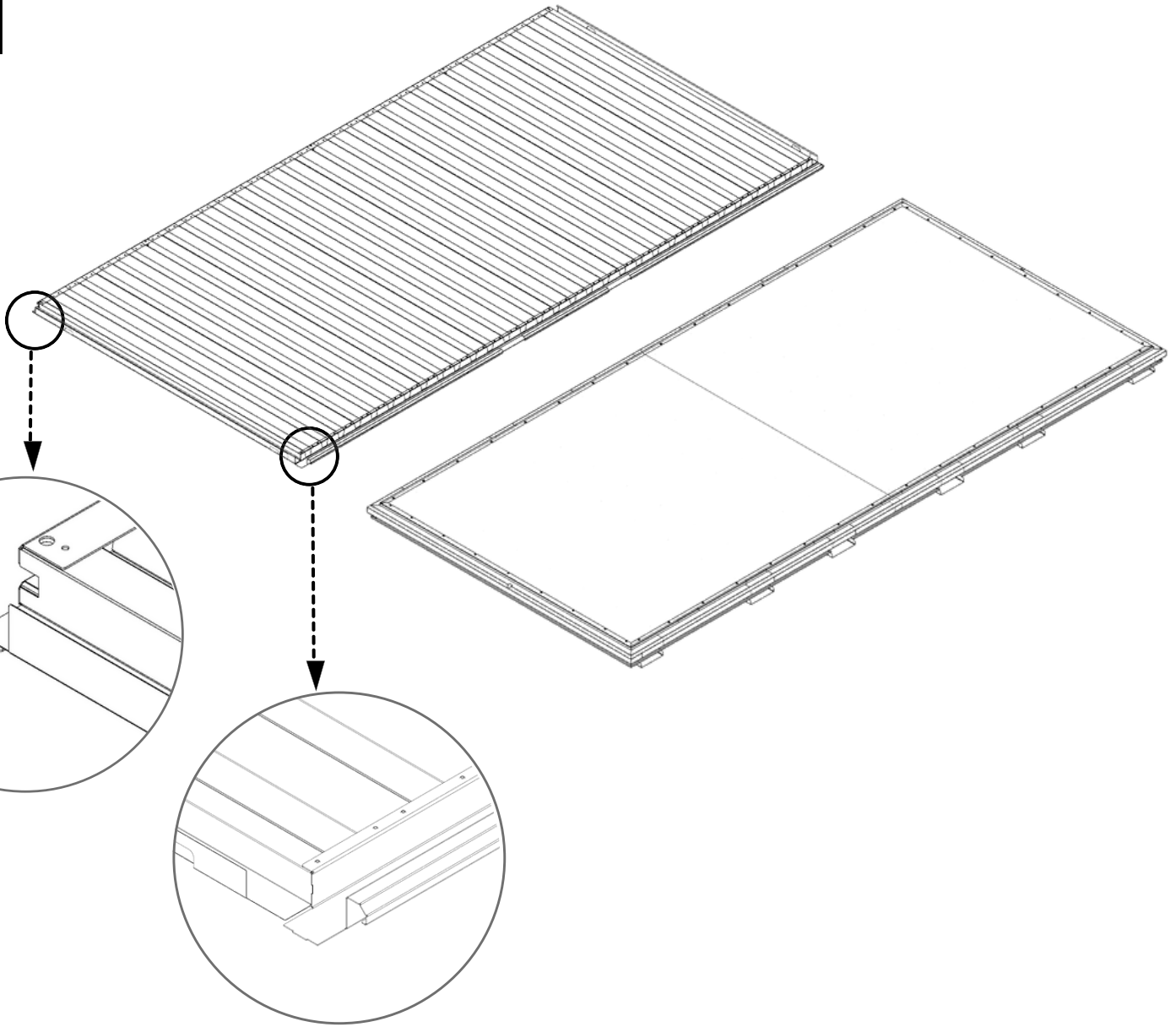

2

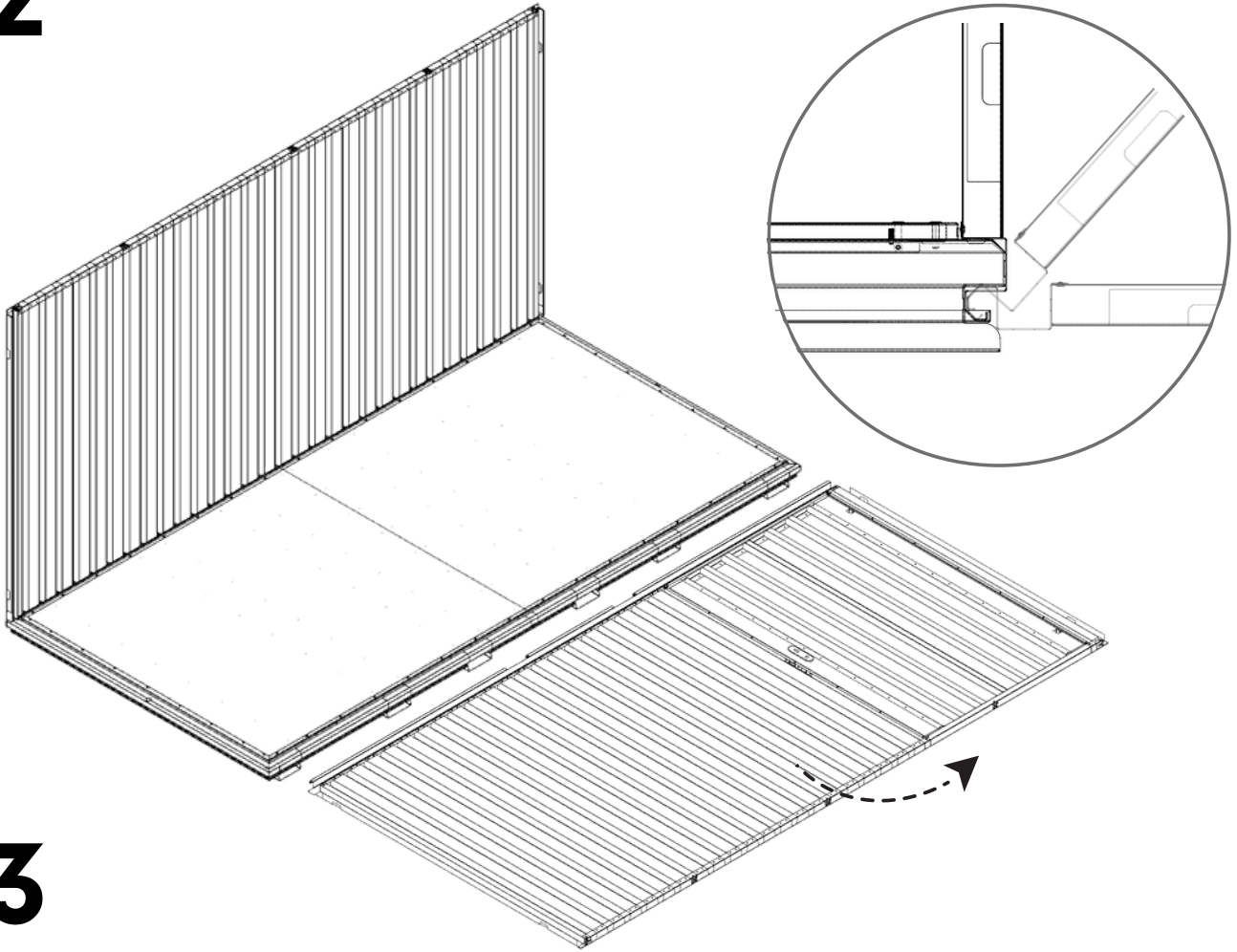

3

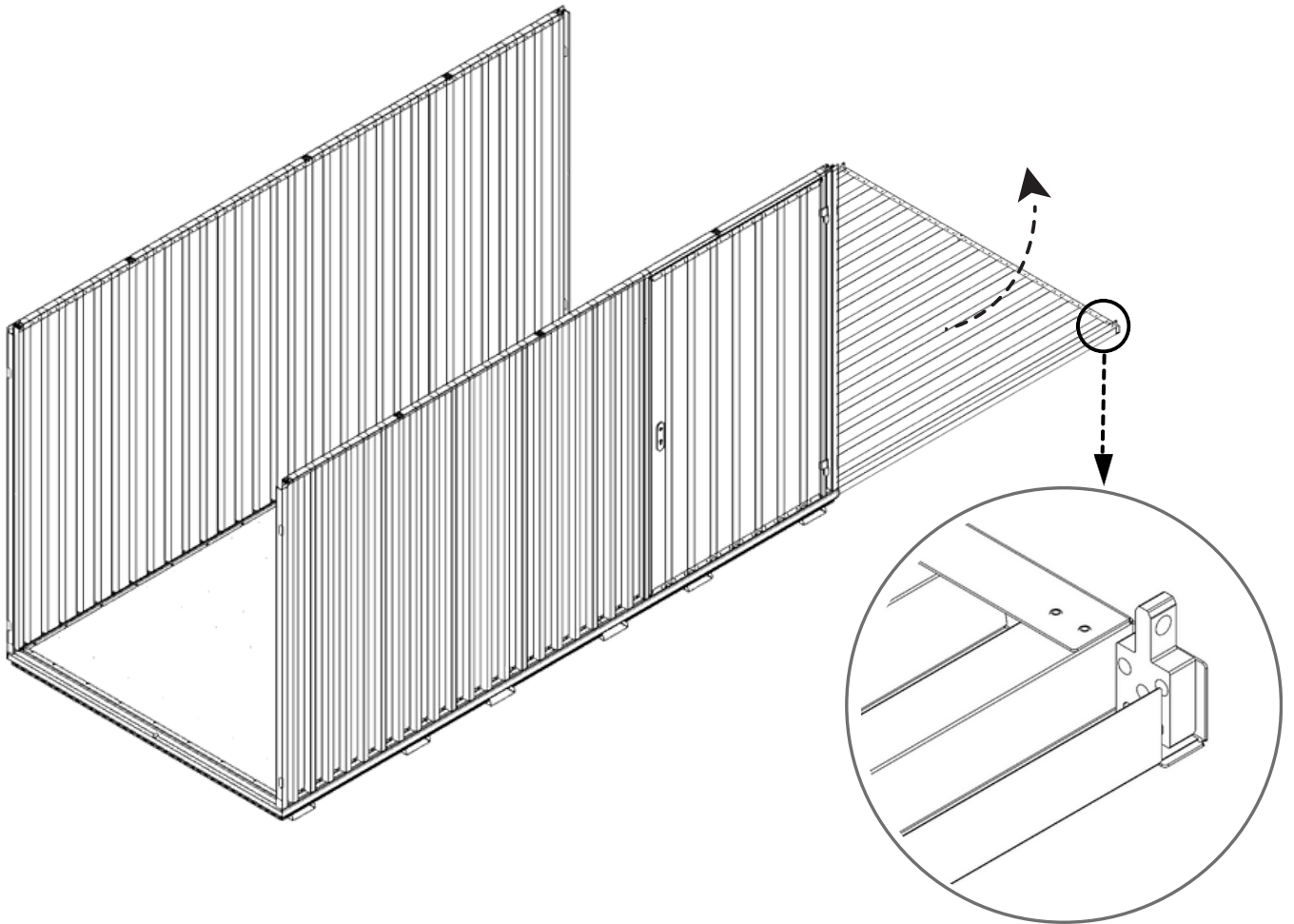

3.1

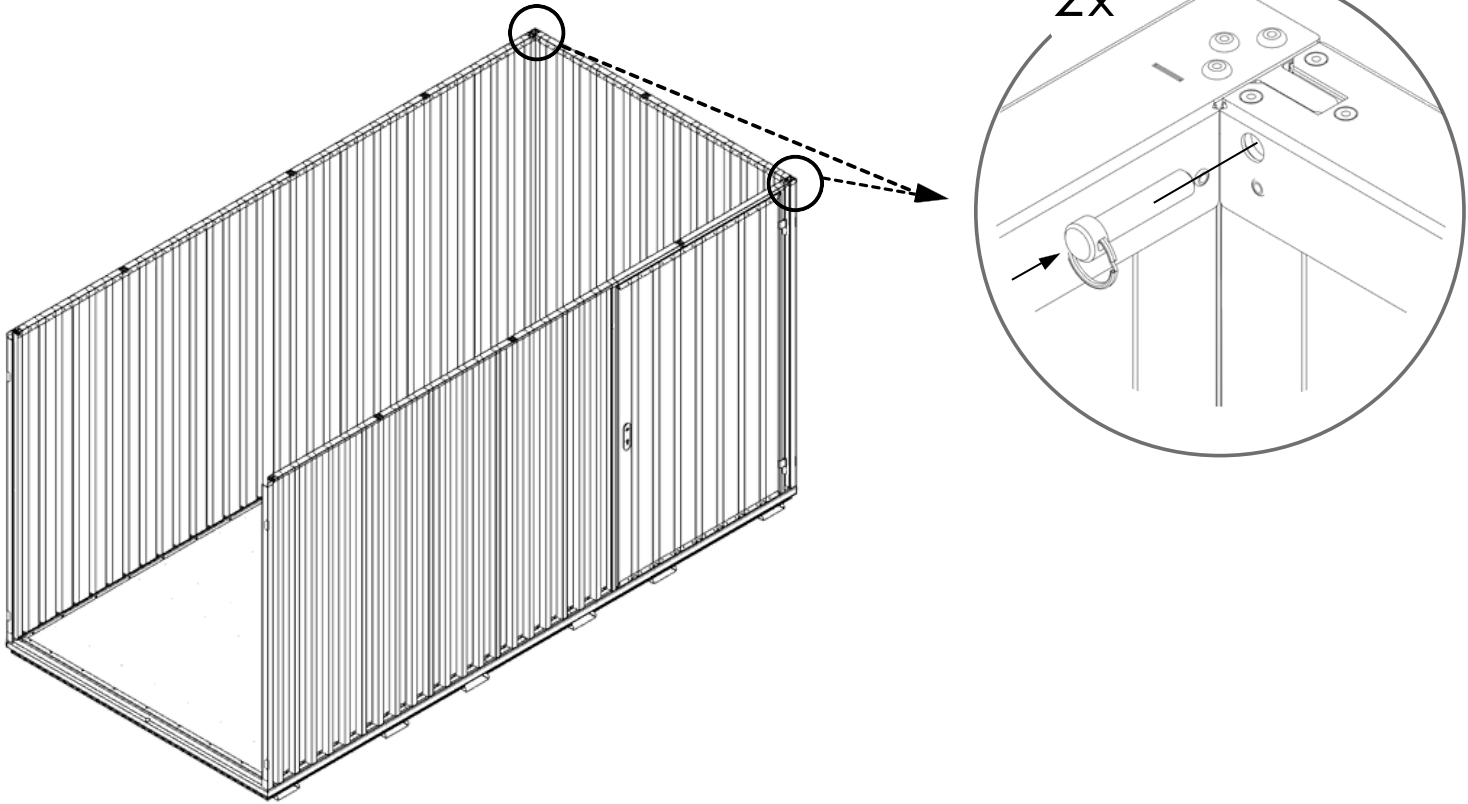



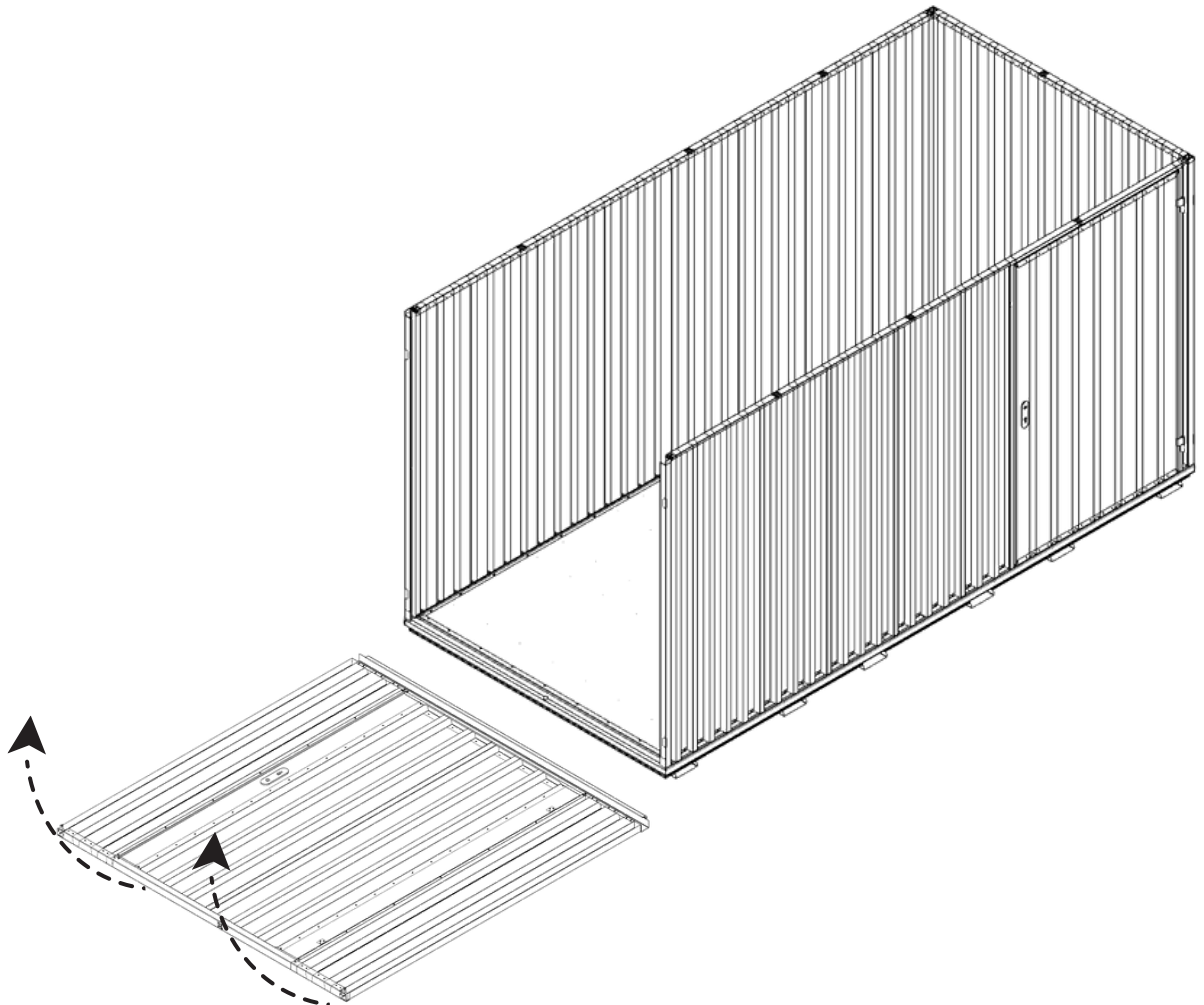



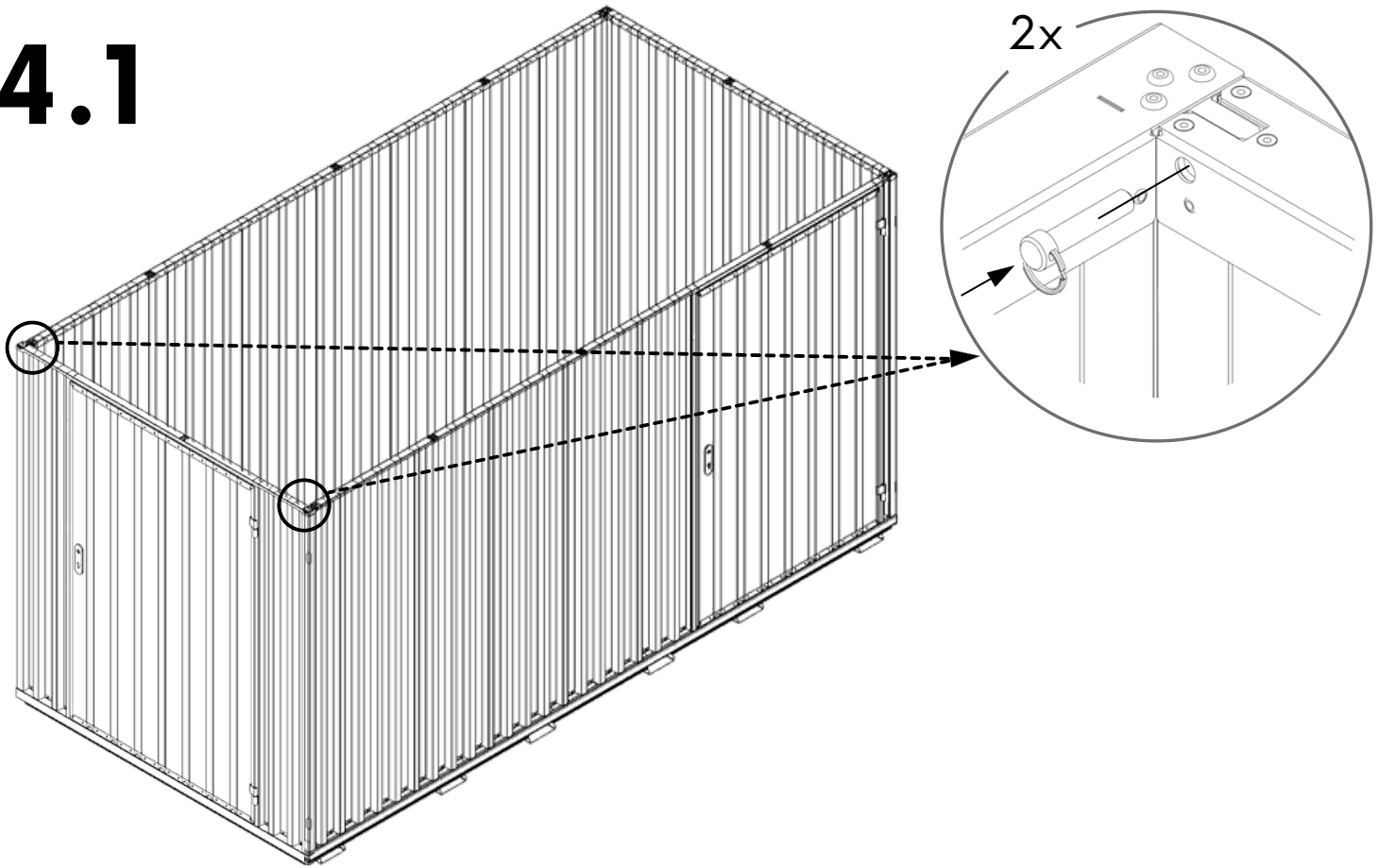

4



4.1



 438 KG	 1640 MM	Model Code: 40.110.440.320 Production Tracking Code:/X09.1.40.440.320    9001 14001 50001	 	
---	--	--	---	---

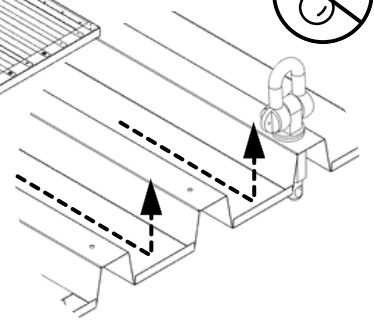
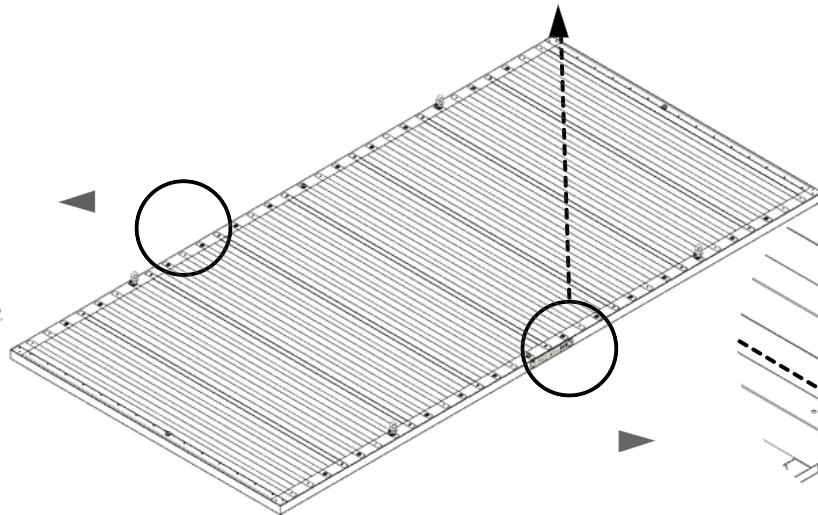
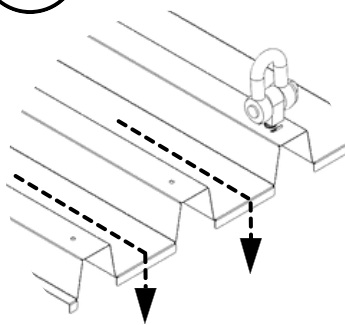

5

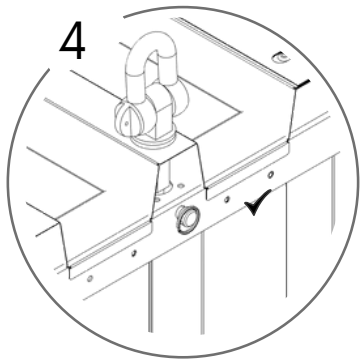
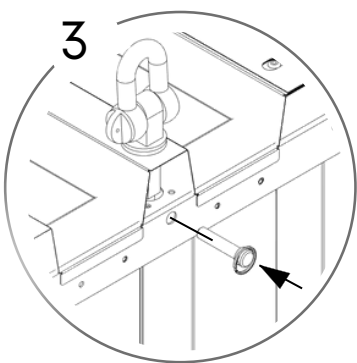
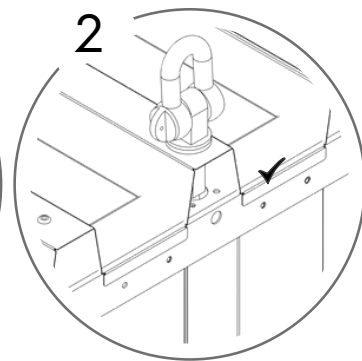
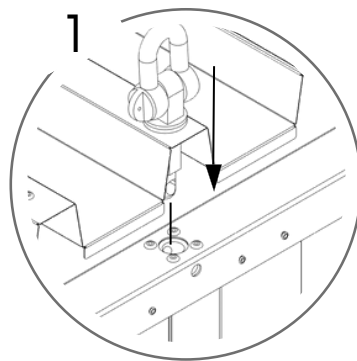
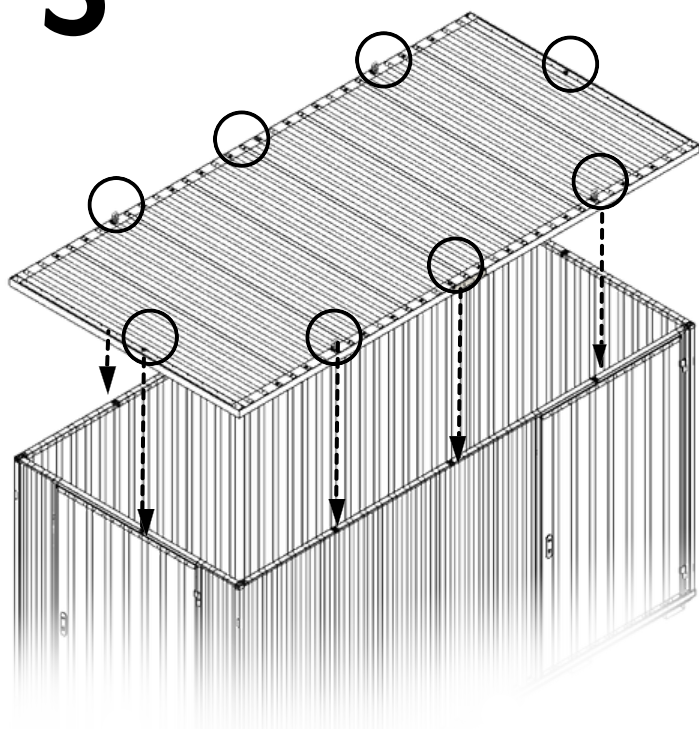

6

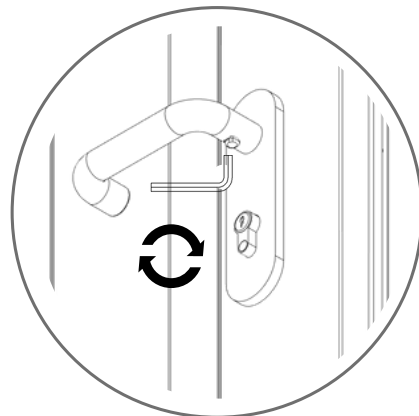
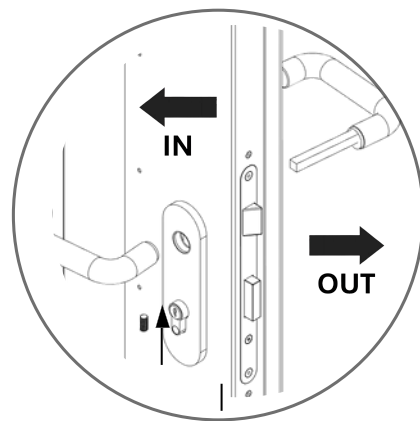

7

