

PRODUCT CODE:50.110.450.330

prefabase
Quick Build Solutions

Instructions and User Guide

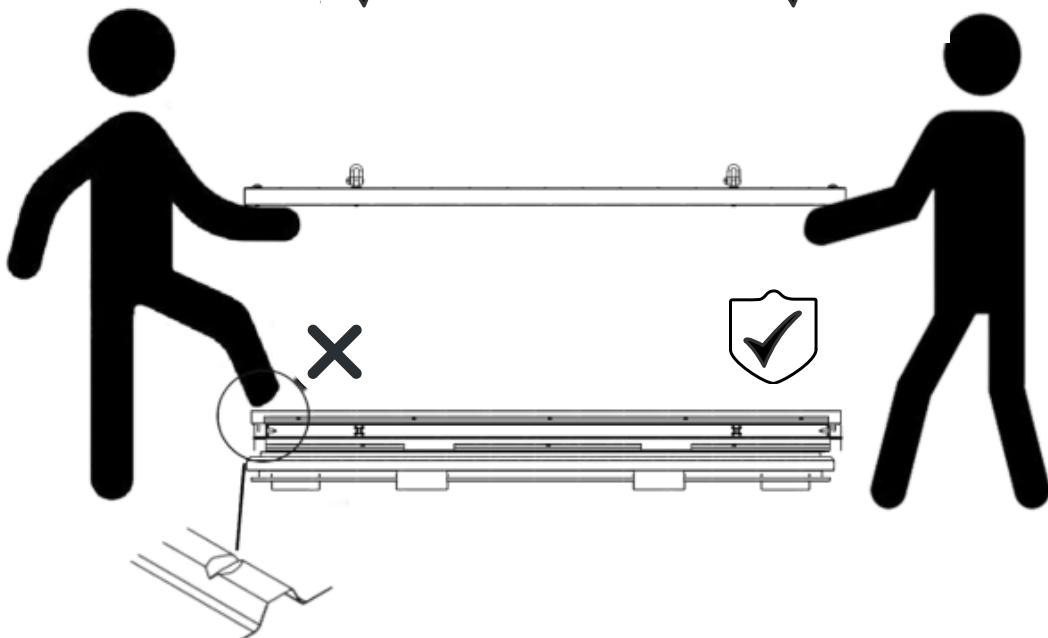
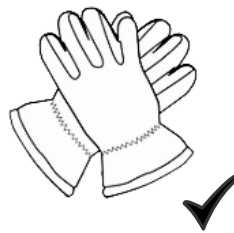

50.0110

1x

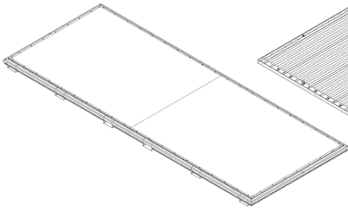

50.0510

1x

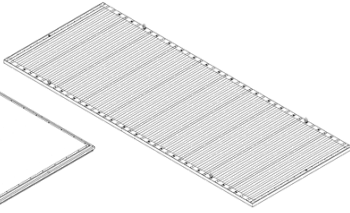

50.0410

1x

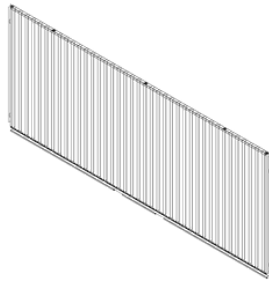

50.0450

1x

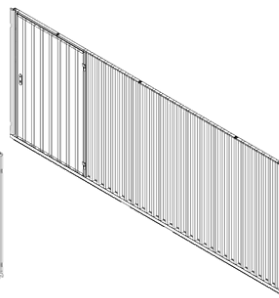

0310

1x

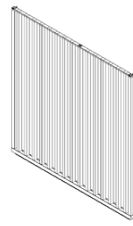

0330

1x



61.101

2x



12x

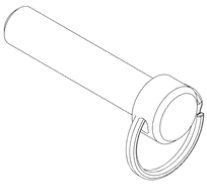

2x

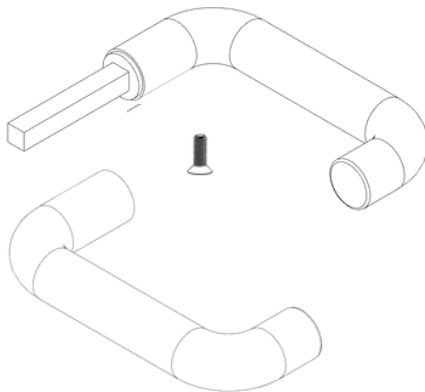

1x

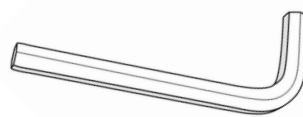

2x



1

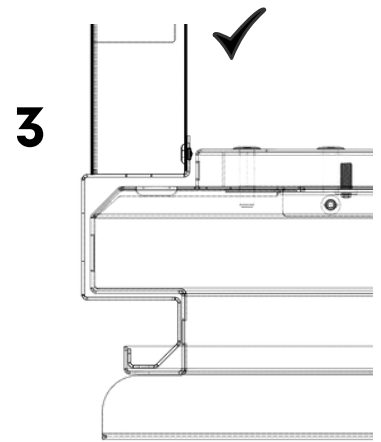
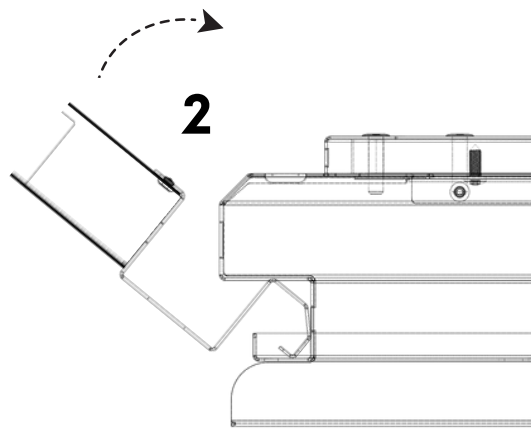
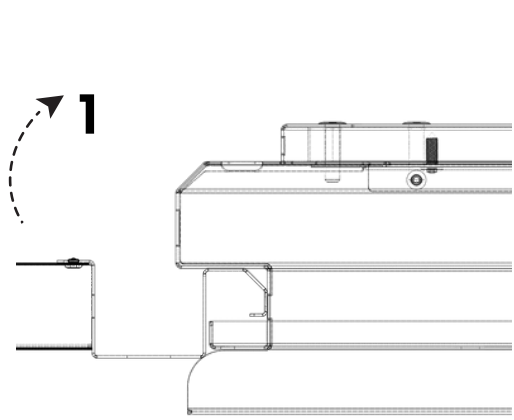
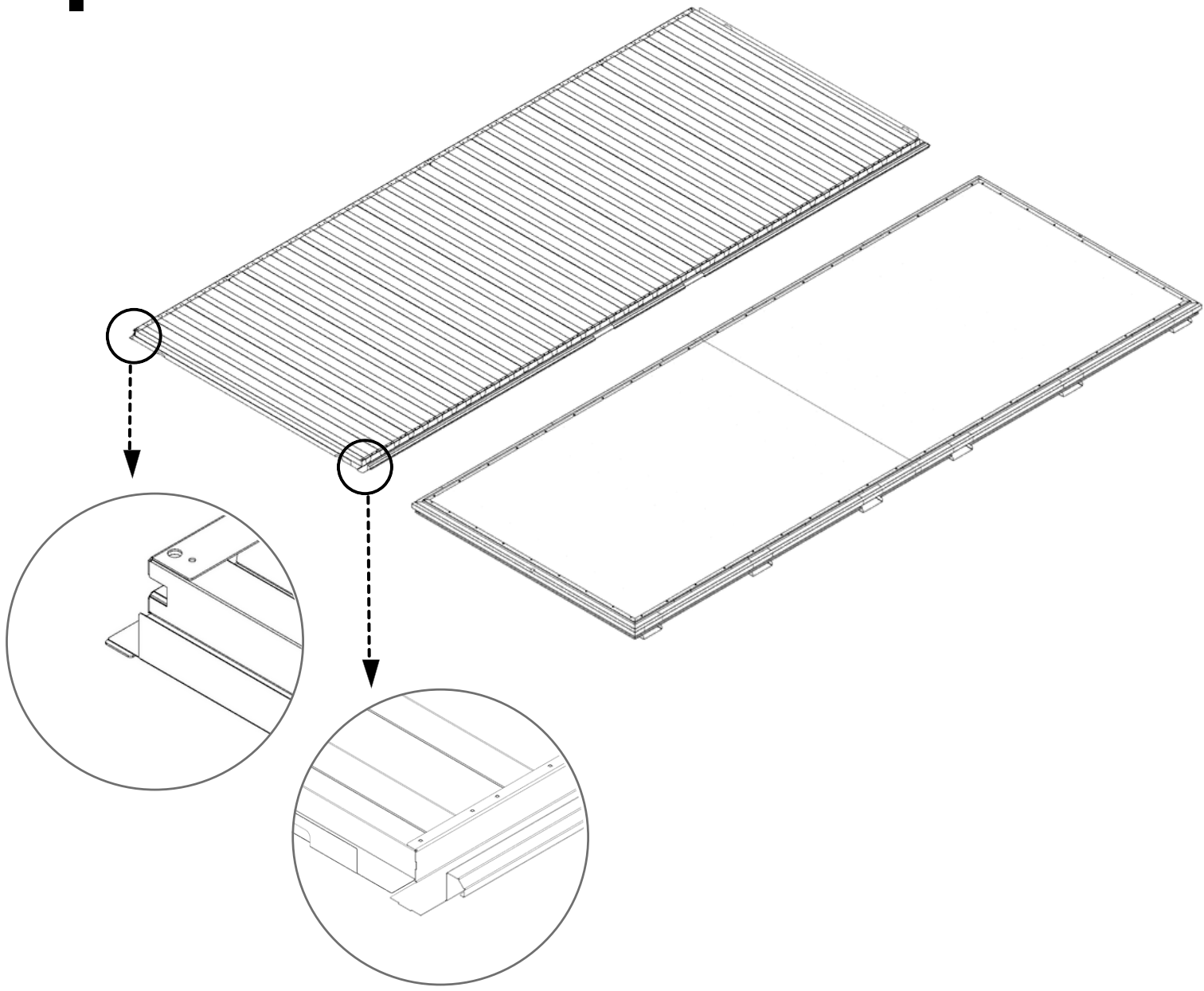

2

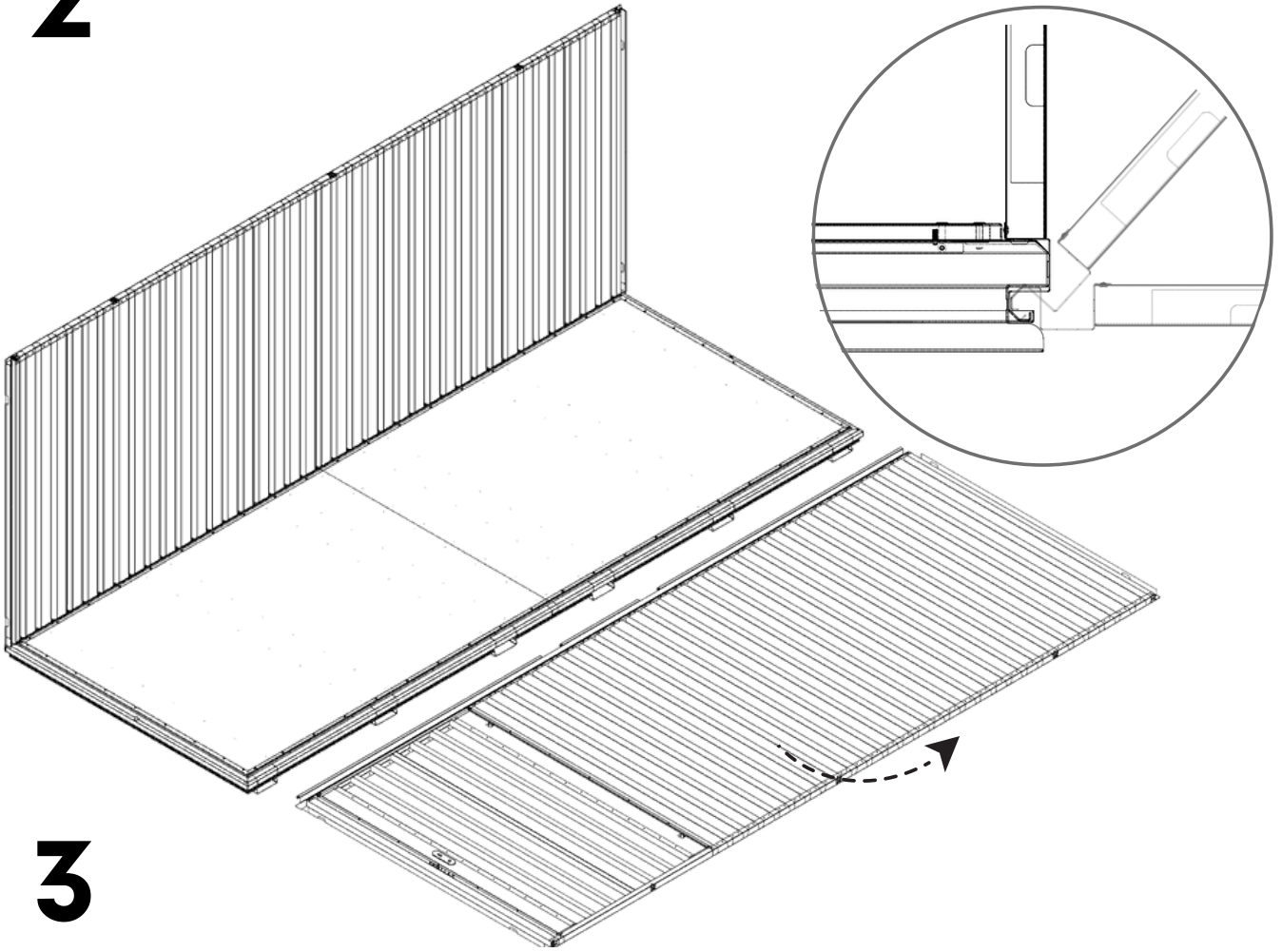

3

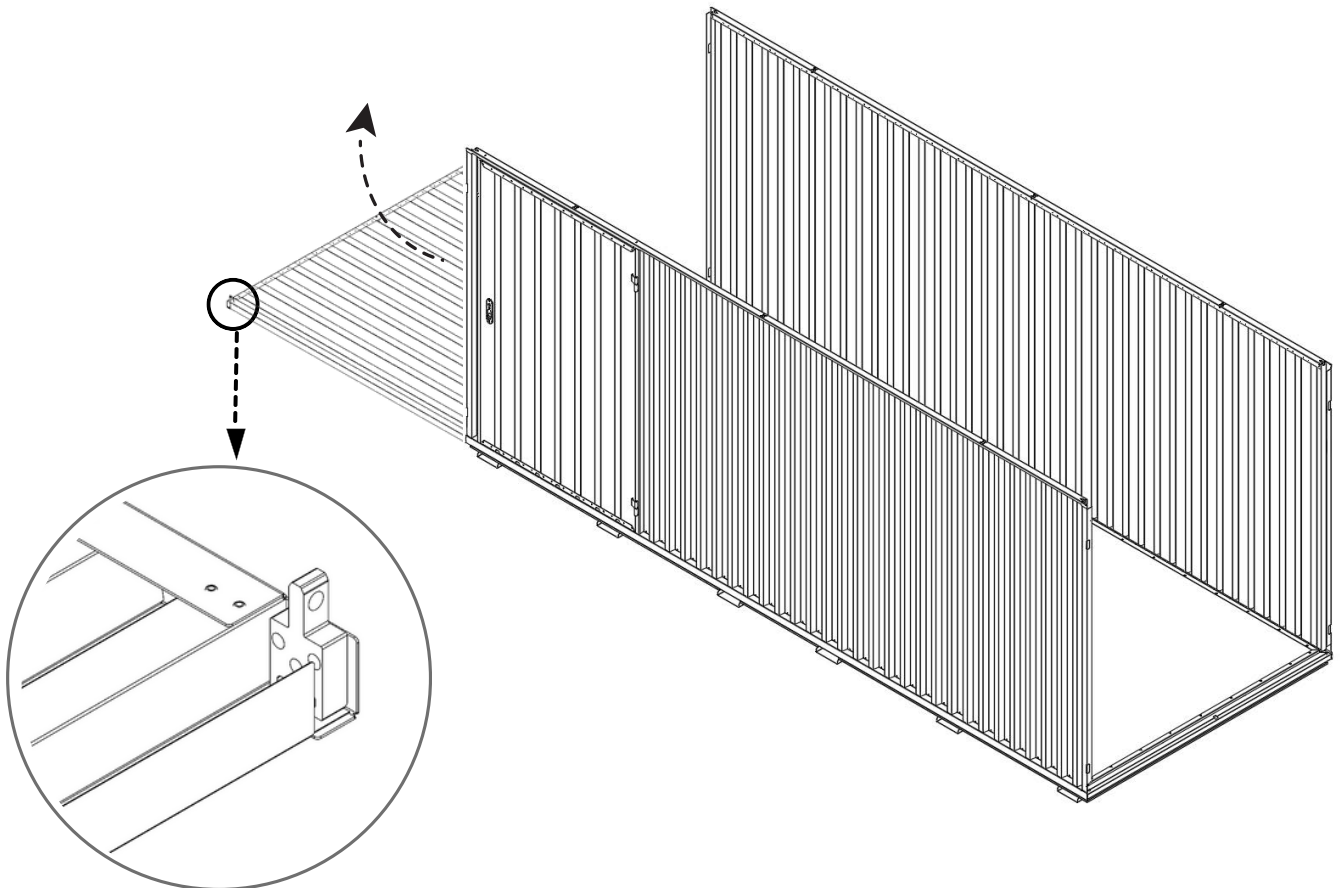

3.1

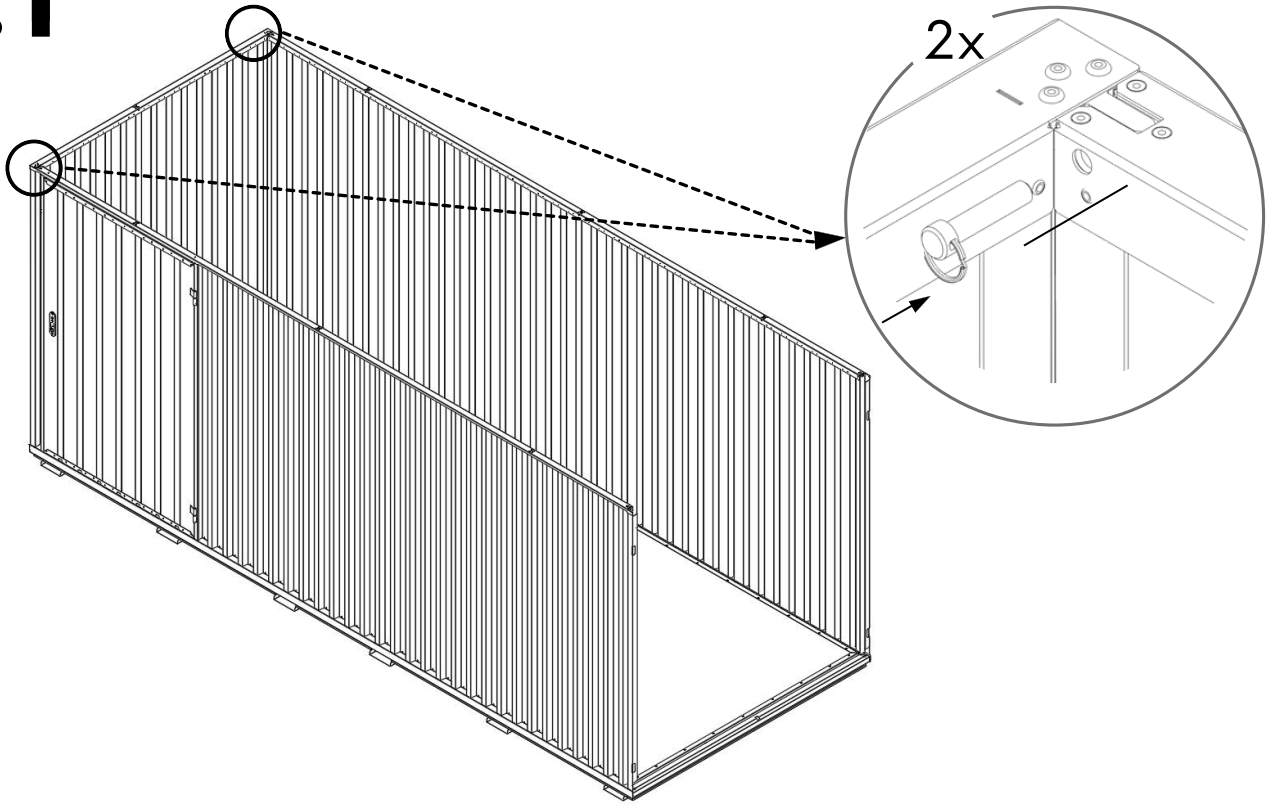



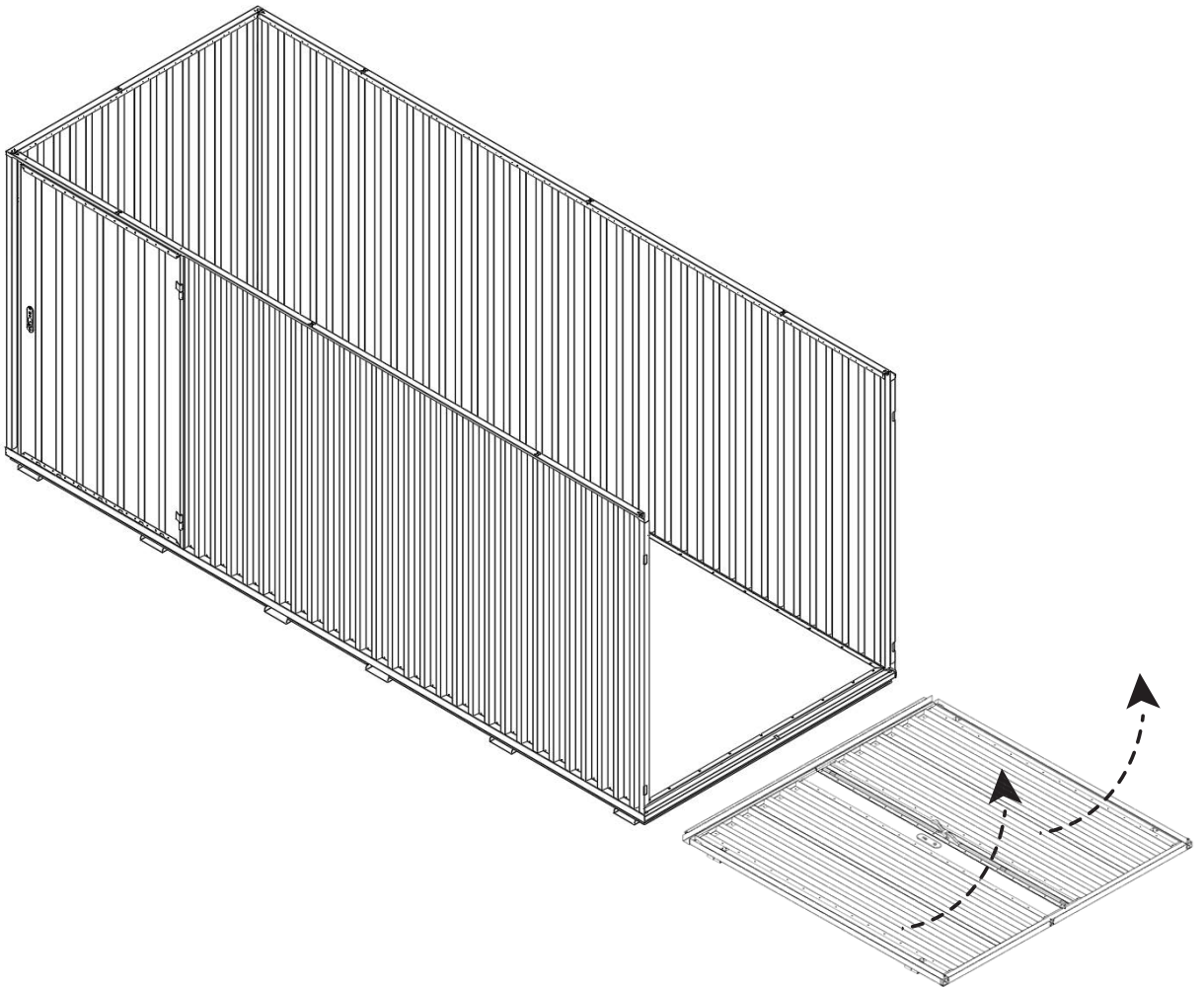



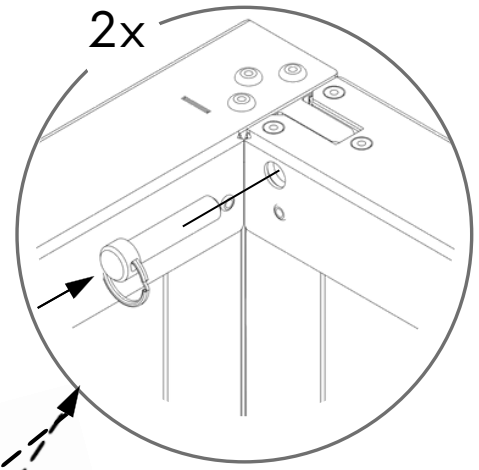
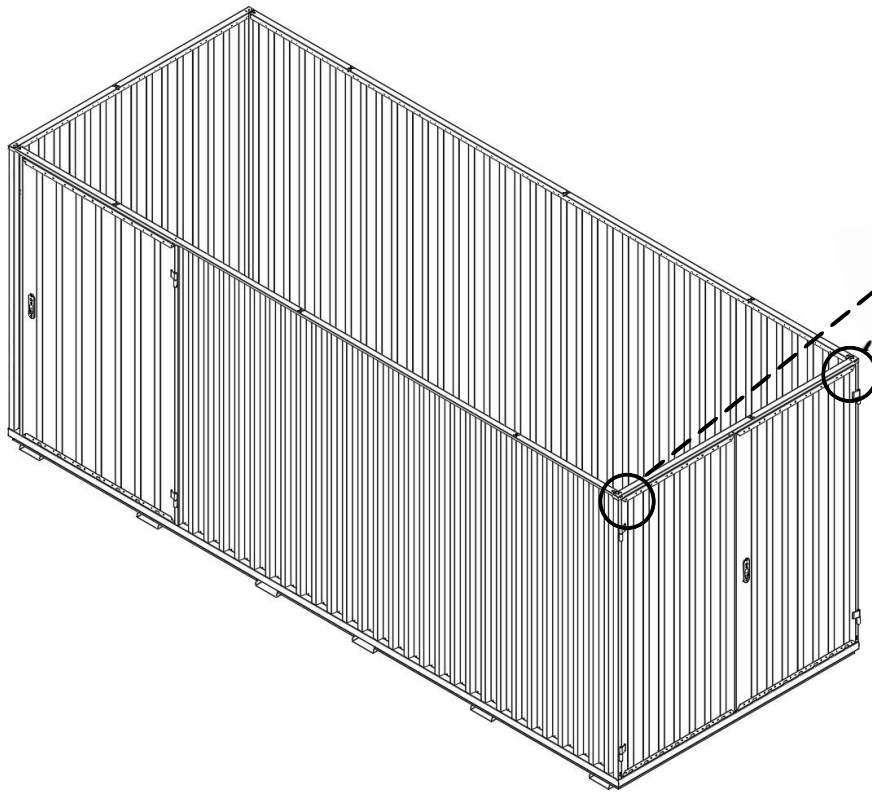

4



4.1



 512 KG	 1640 MM	Model Code: 50.110.450.330 Production Tracking Code:/X09.1.50.450.330    9001 14001 50001	 	
---	--	---	---	---

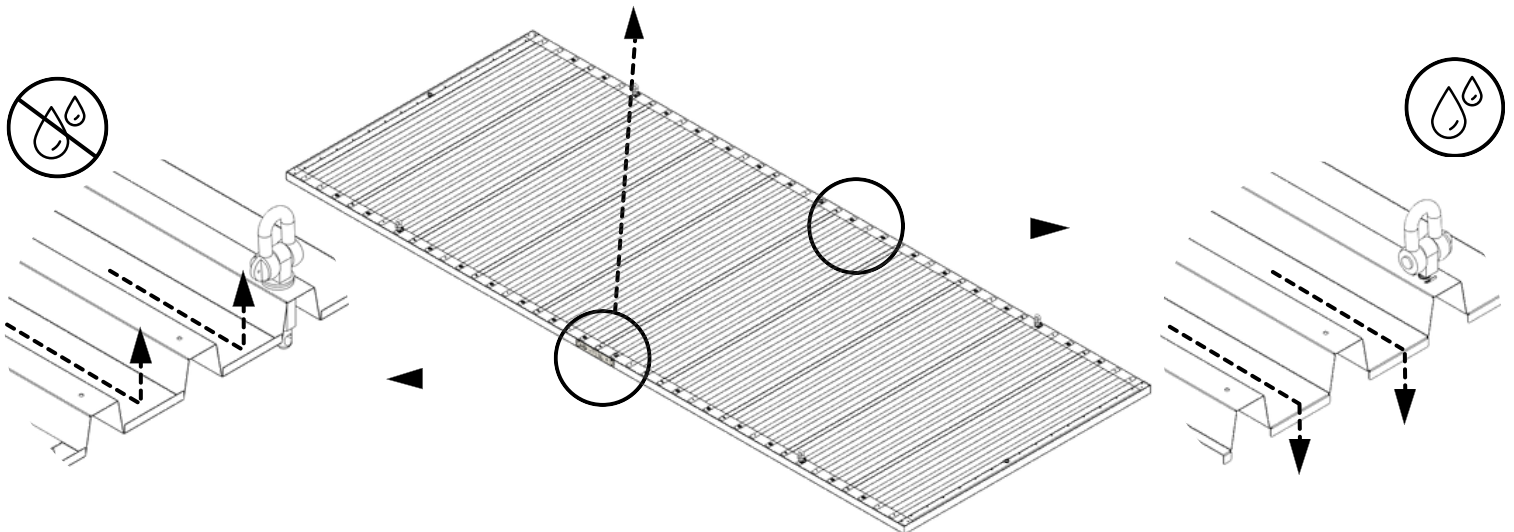

5

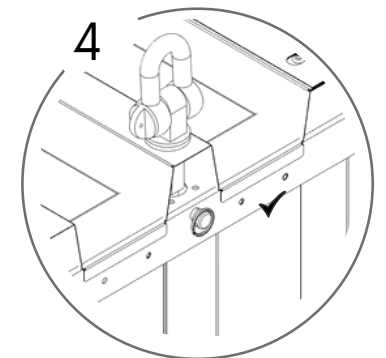
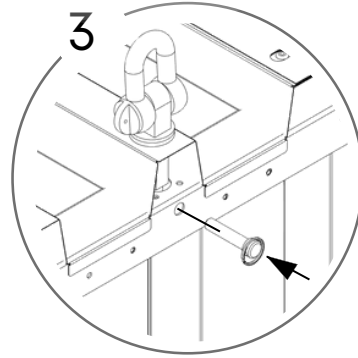
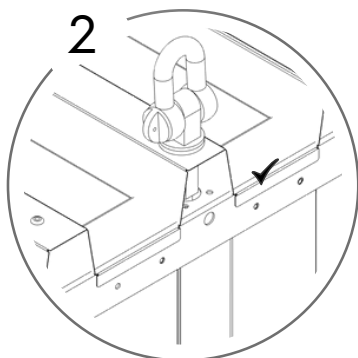
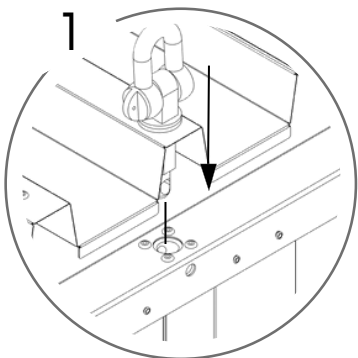
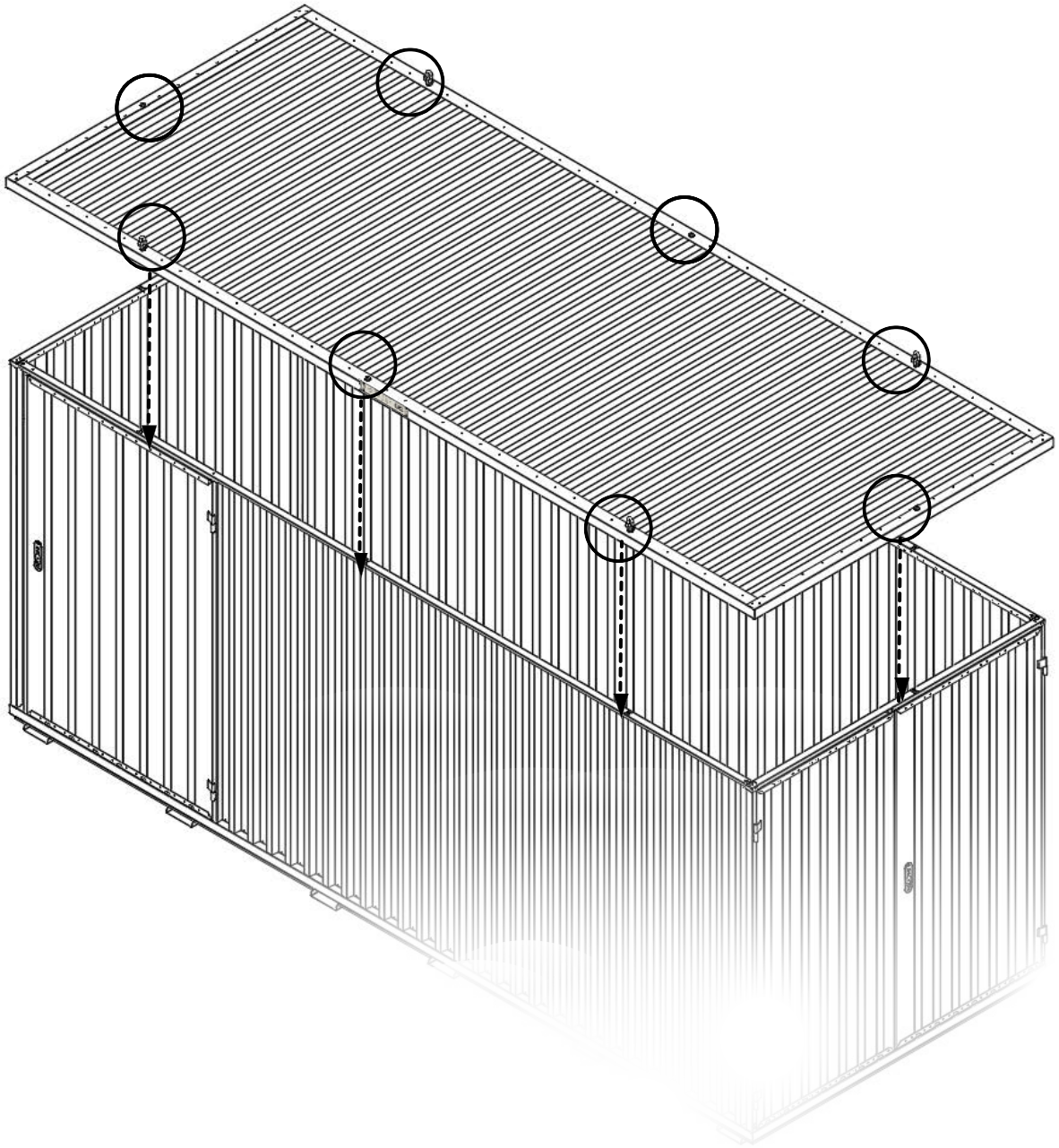

6

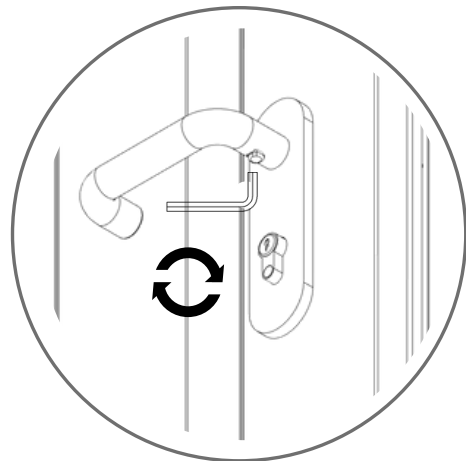
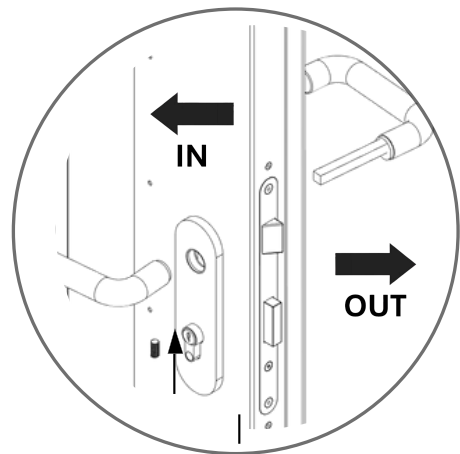
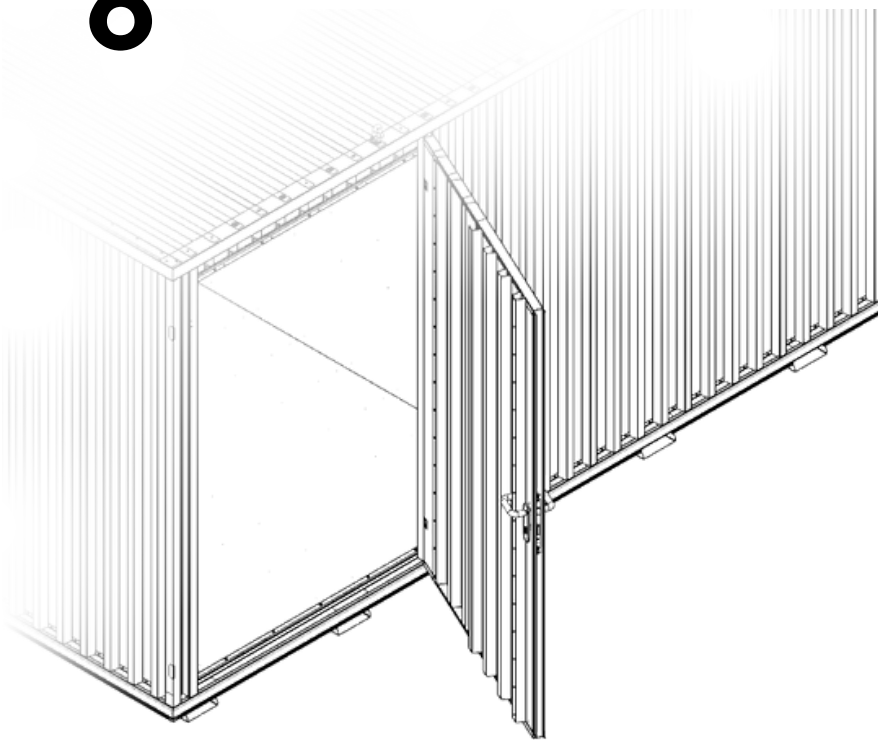

7

