

PRODUCT CODE:3033.110.430.450

**prefabase**  
Quick Build Solutions

Instructions and User Guide

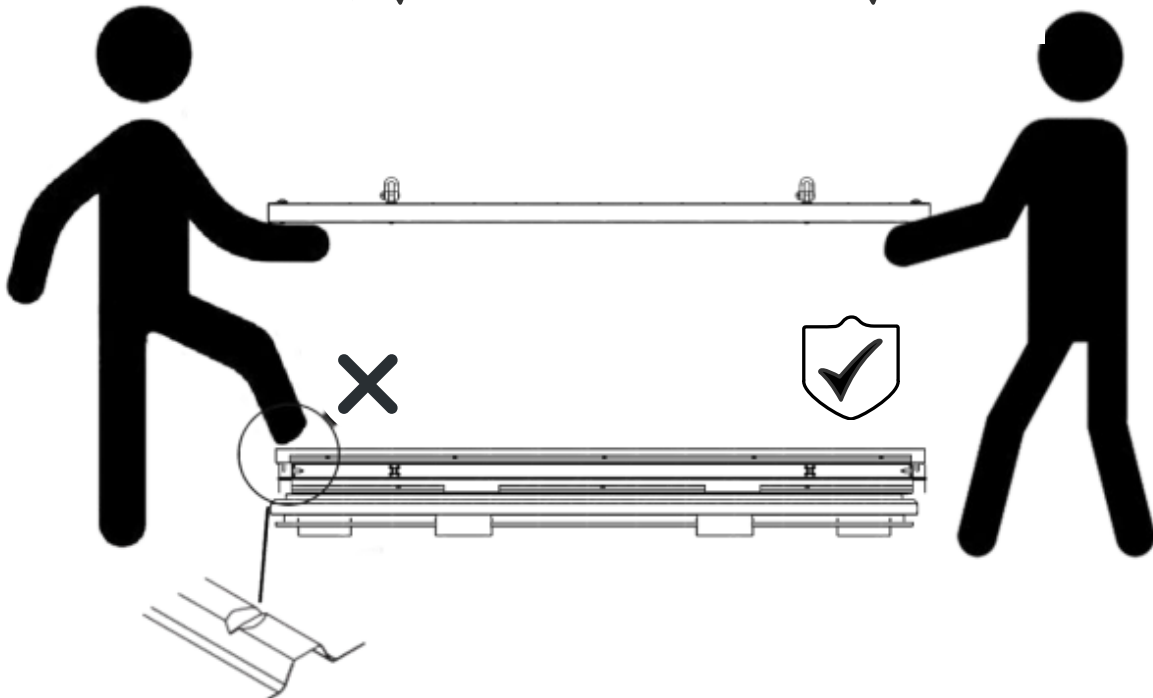
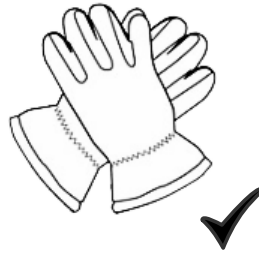

30.0110

3x

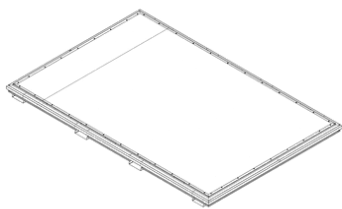

30.0510

3x

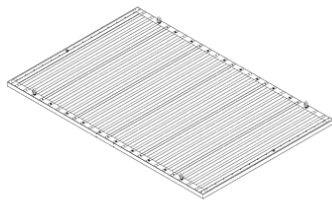

303.0110

2x



303.0510

2x



30.0430

1x



30.0450

1x

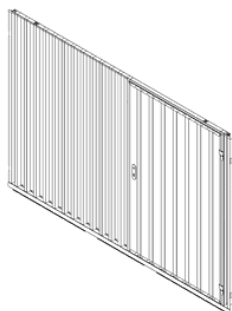

0310

6x

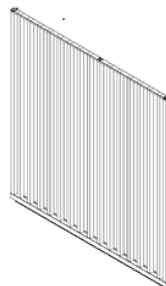

305.20.08

4x



305.20.09

4x



61.101

4x



30x

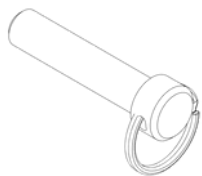

2x

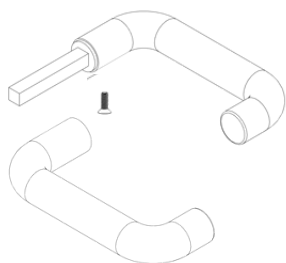

20x



20x



20x



1x



2x



**1**

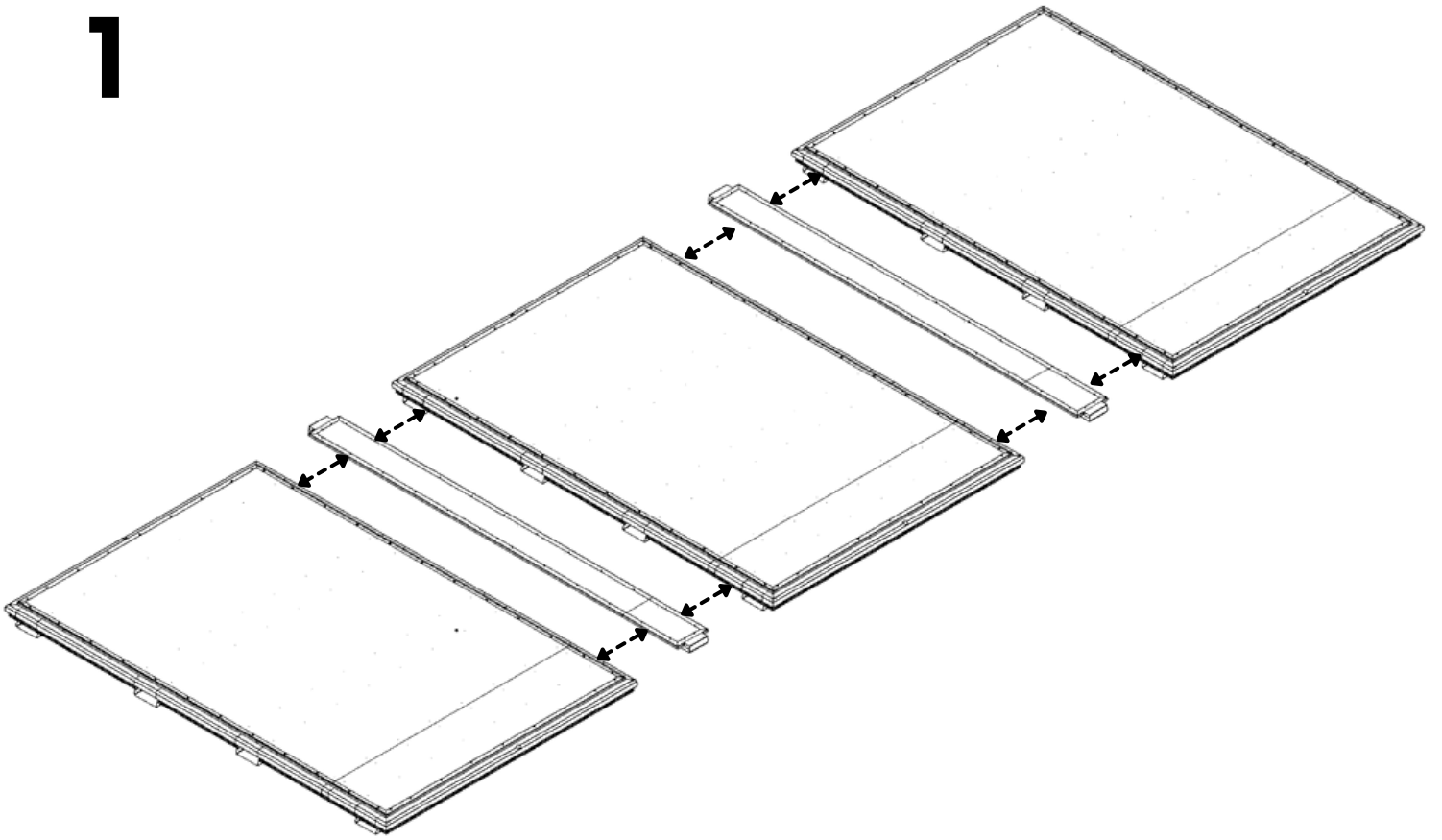

**2**

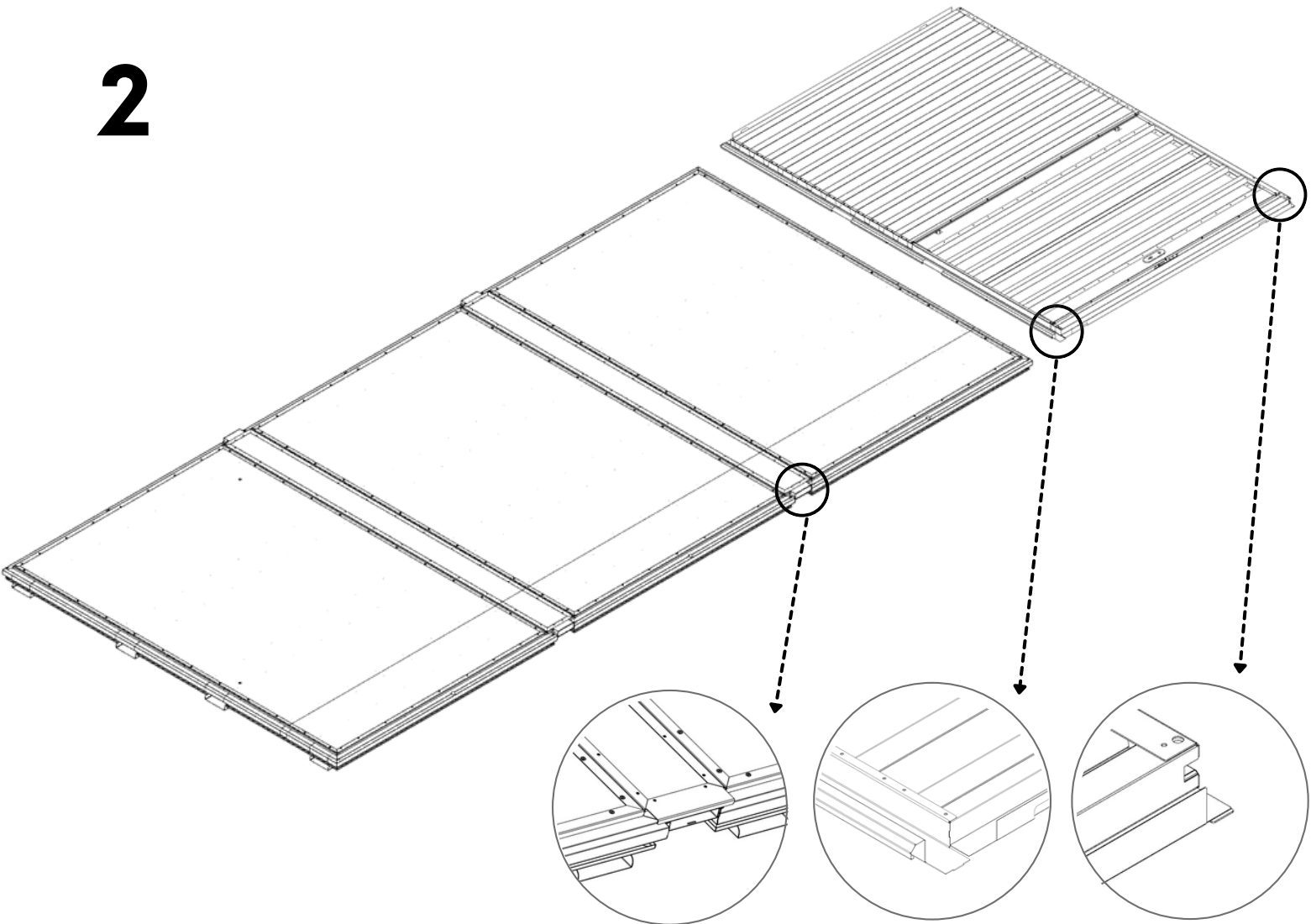

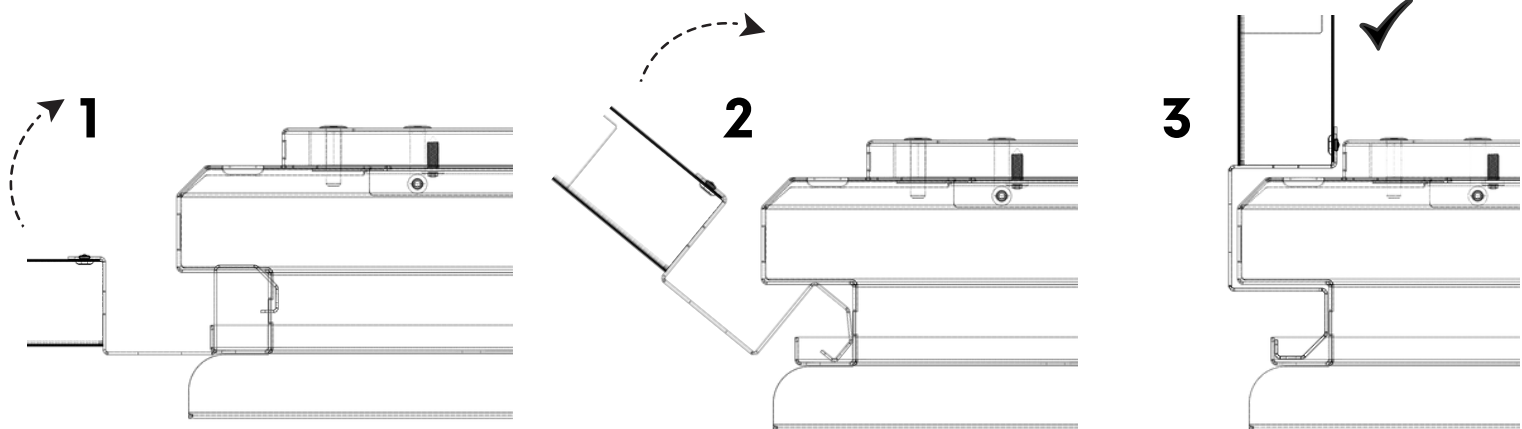

3

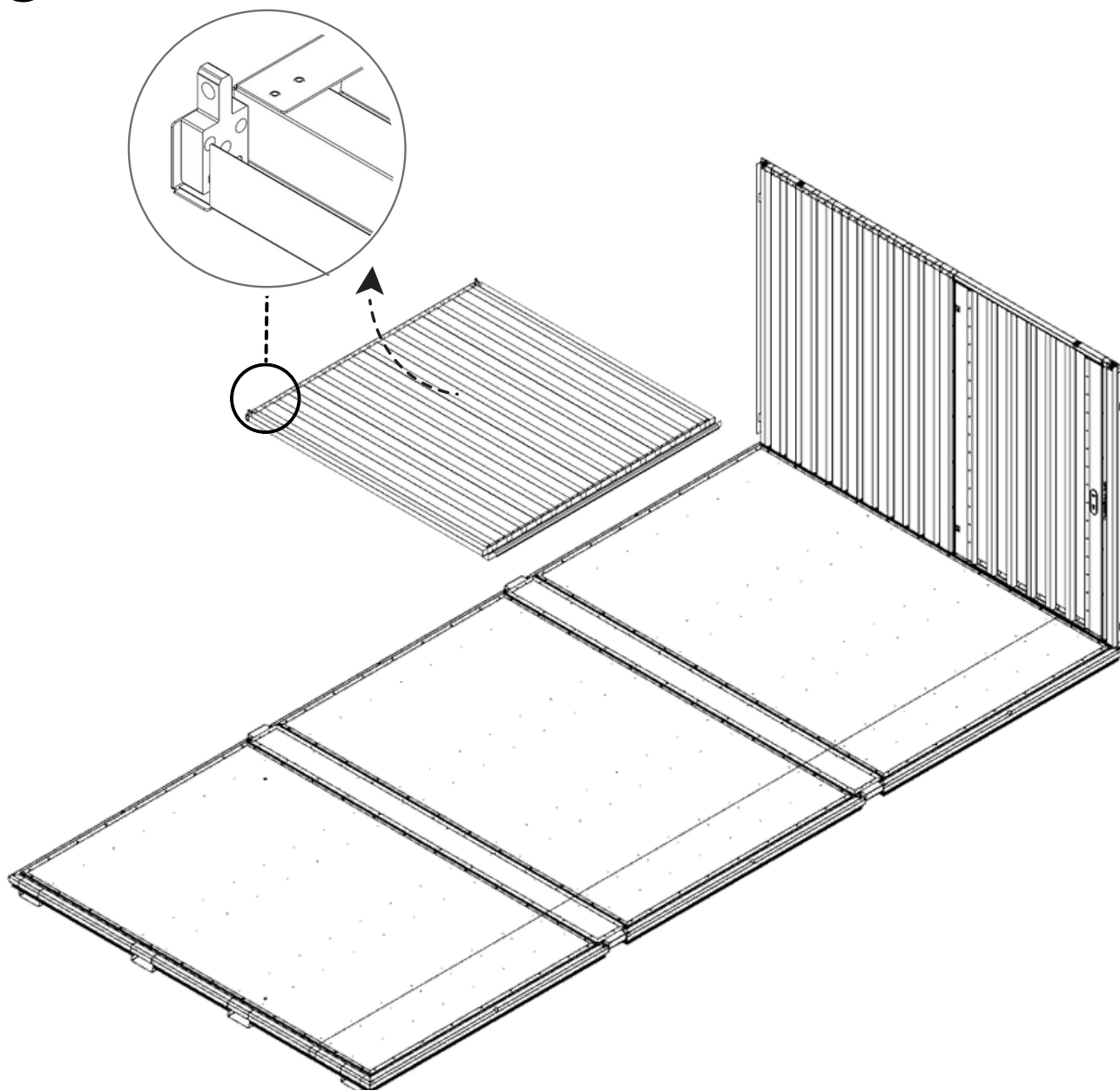

4

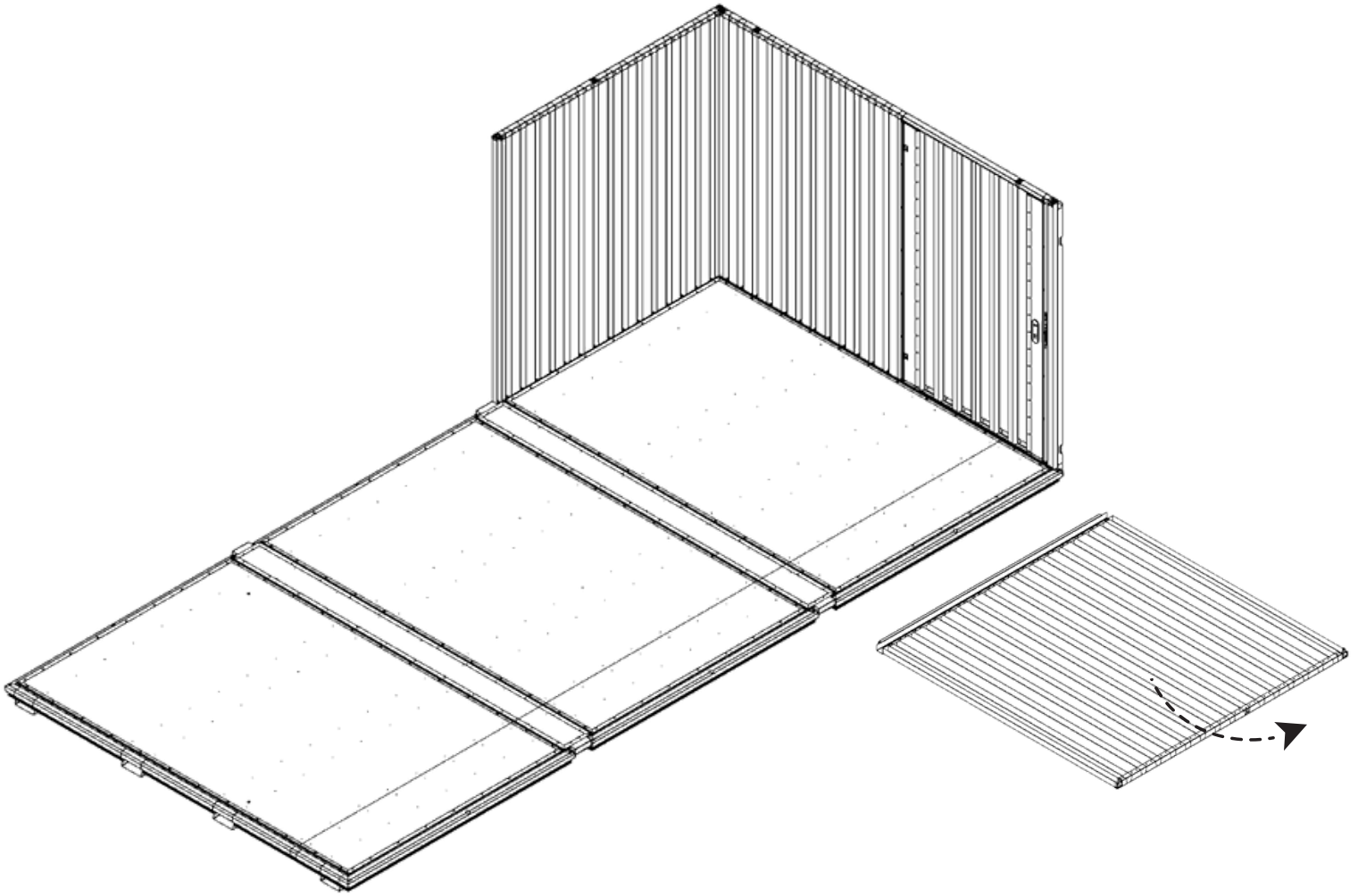

# 4.1

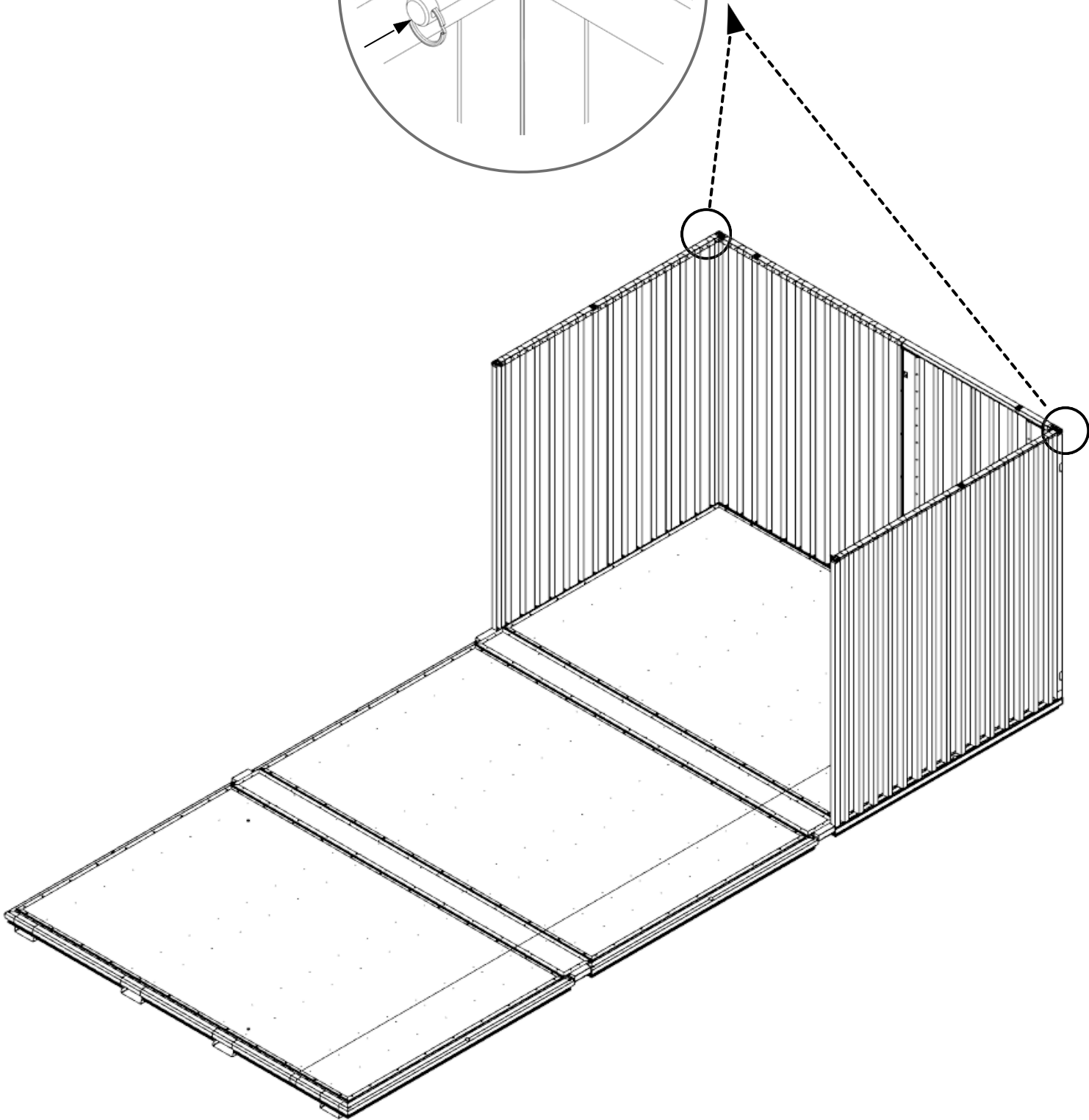
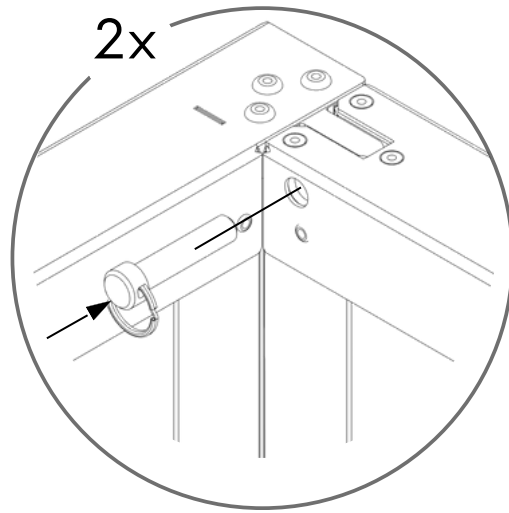

5

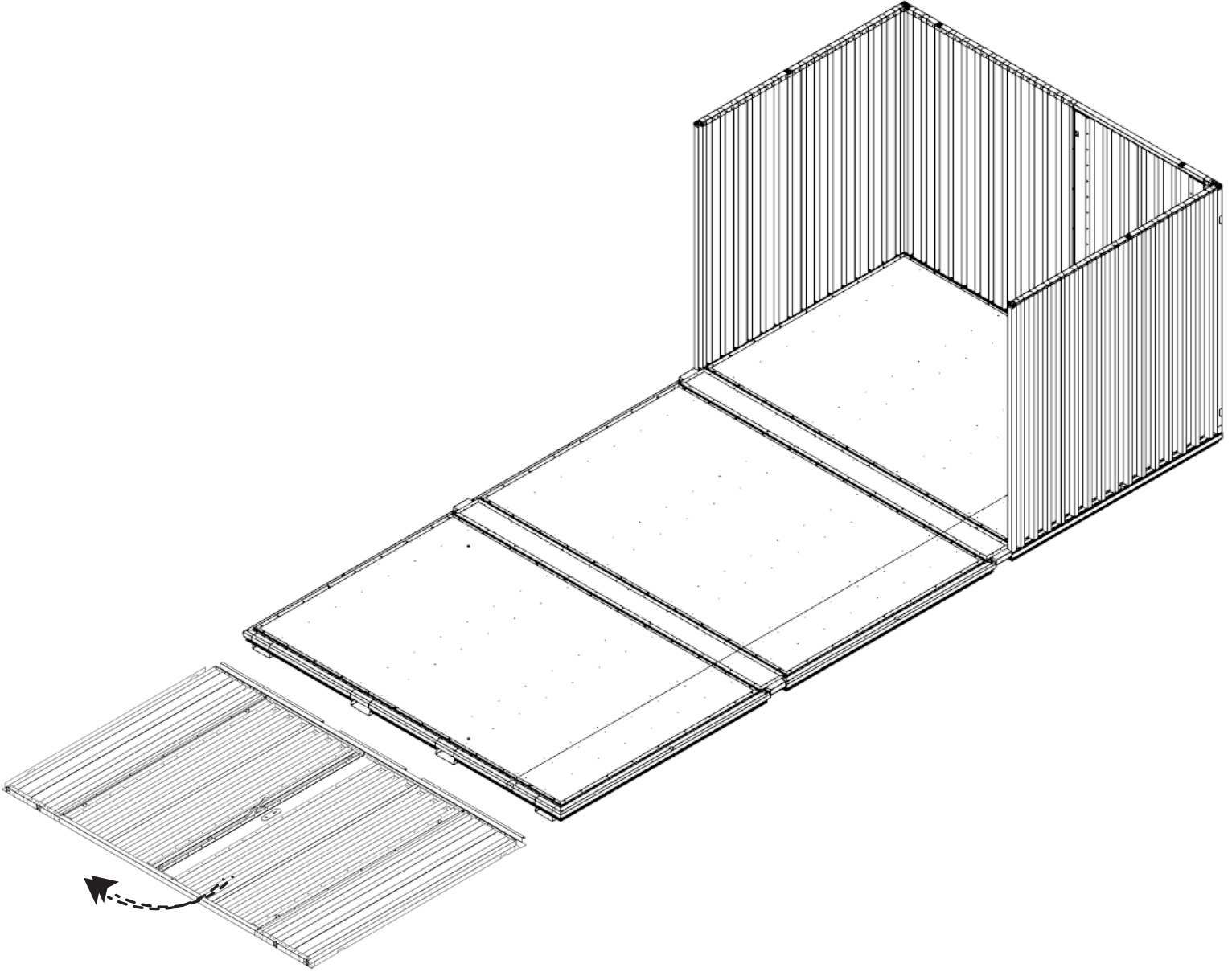

6

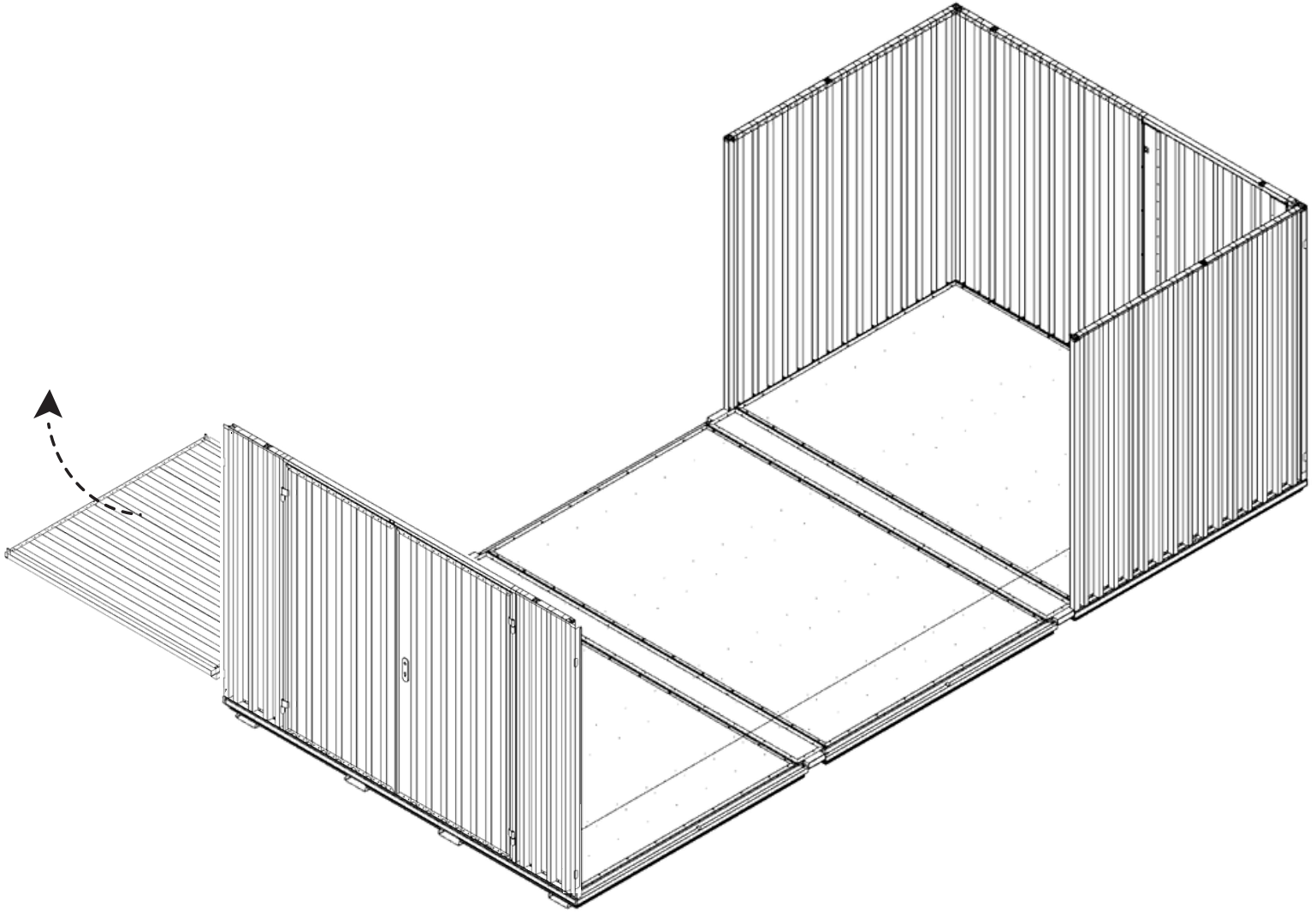



7

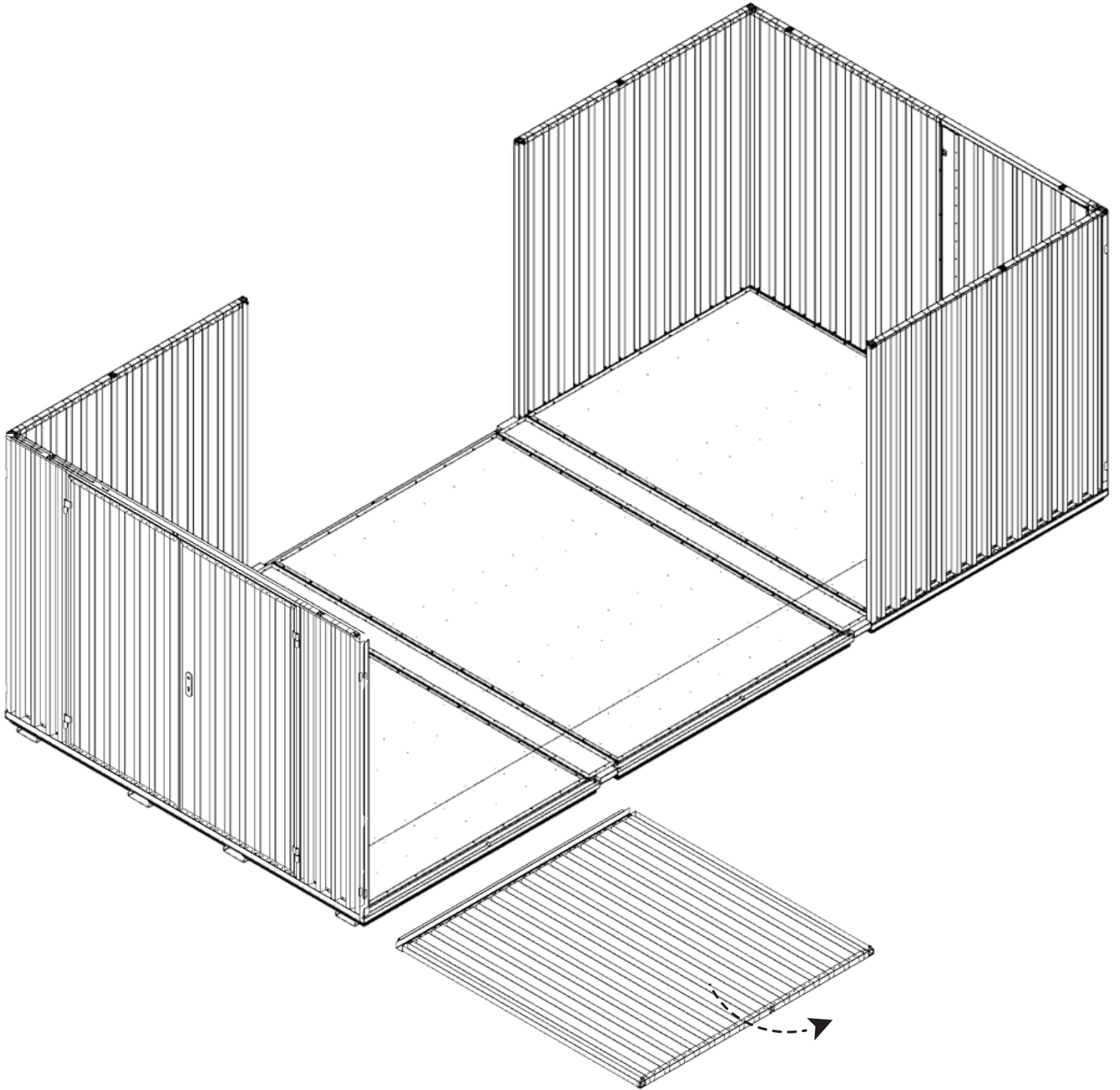

# 7.1

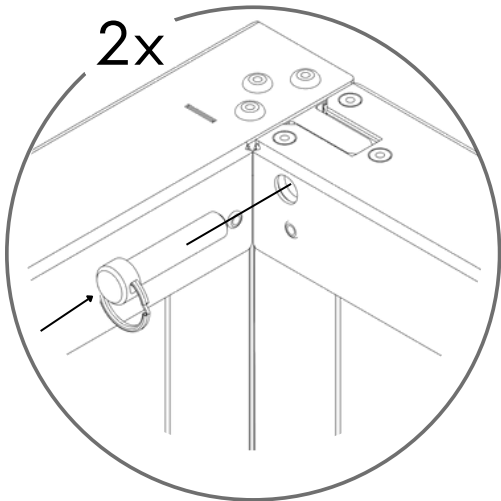
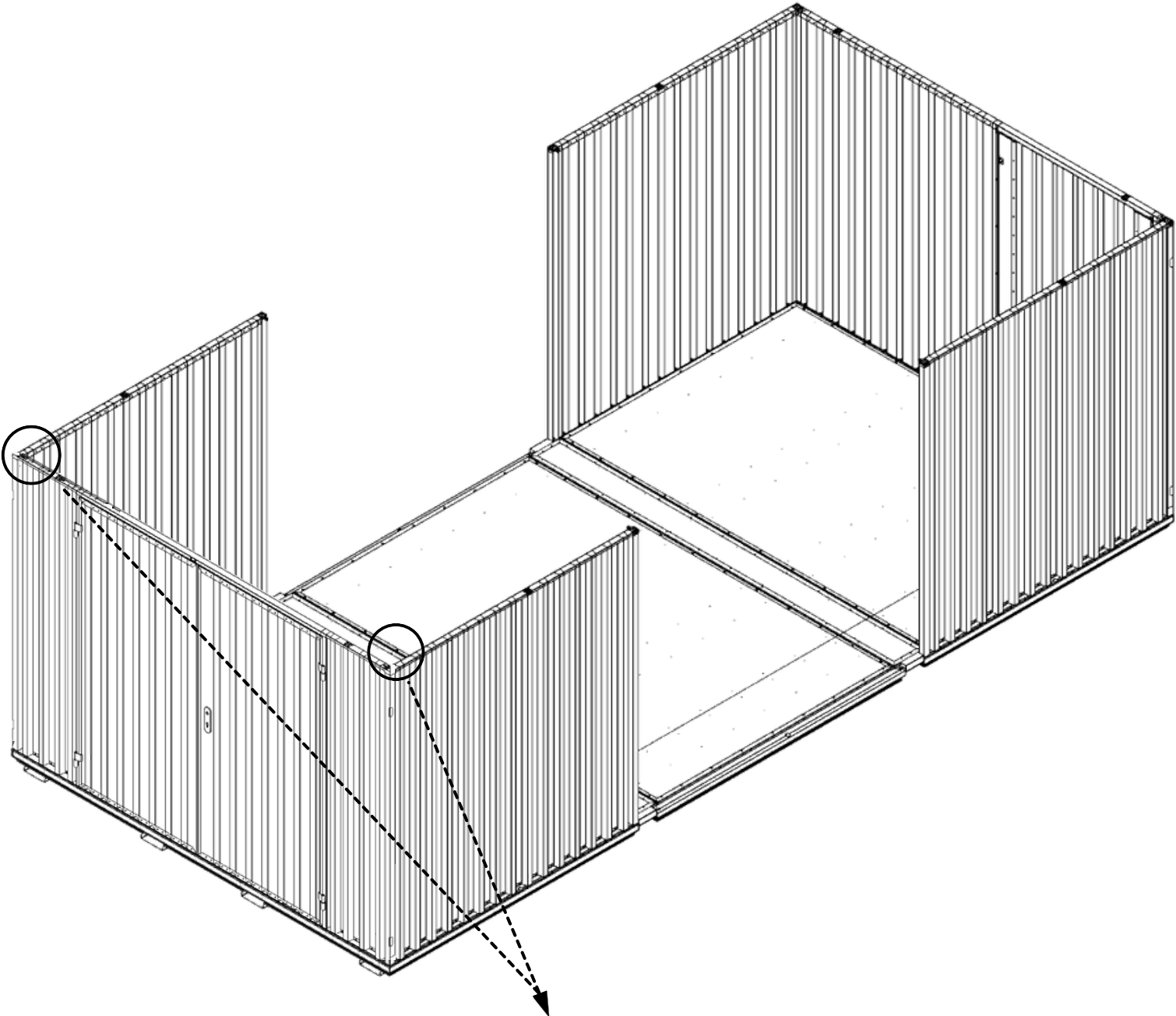

8

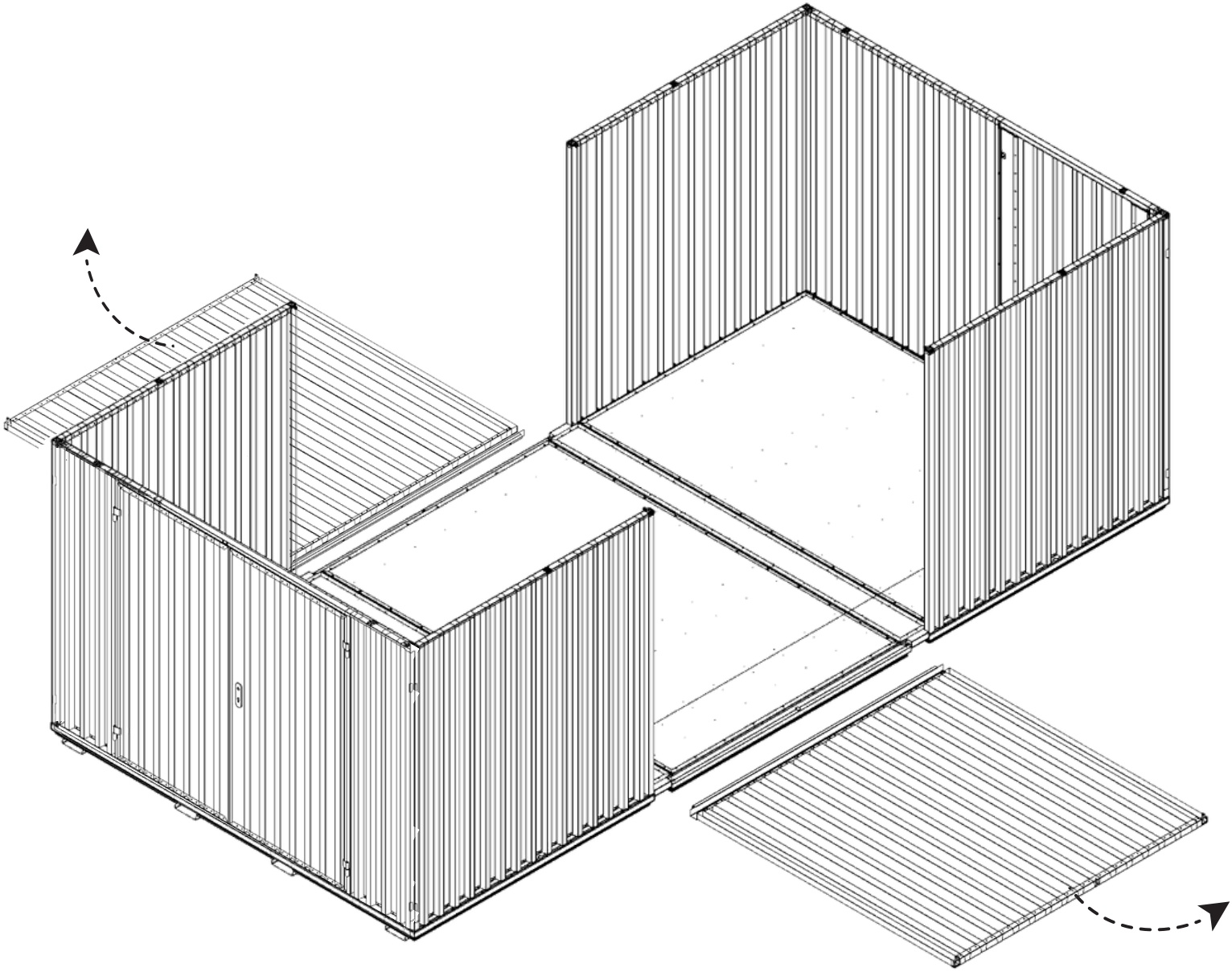

9

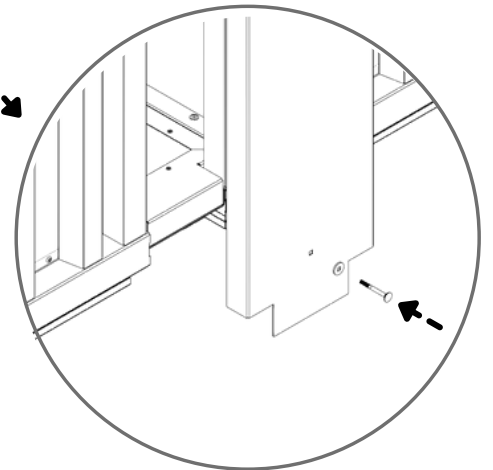
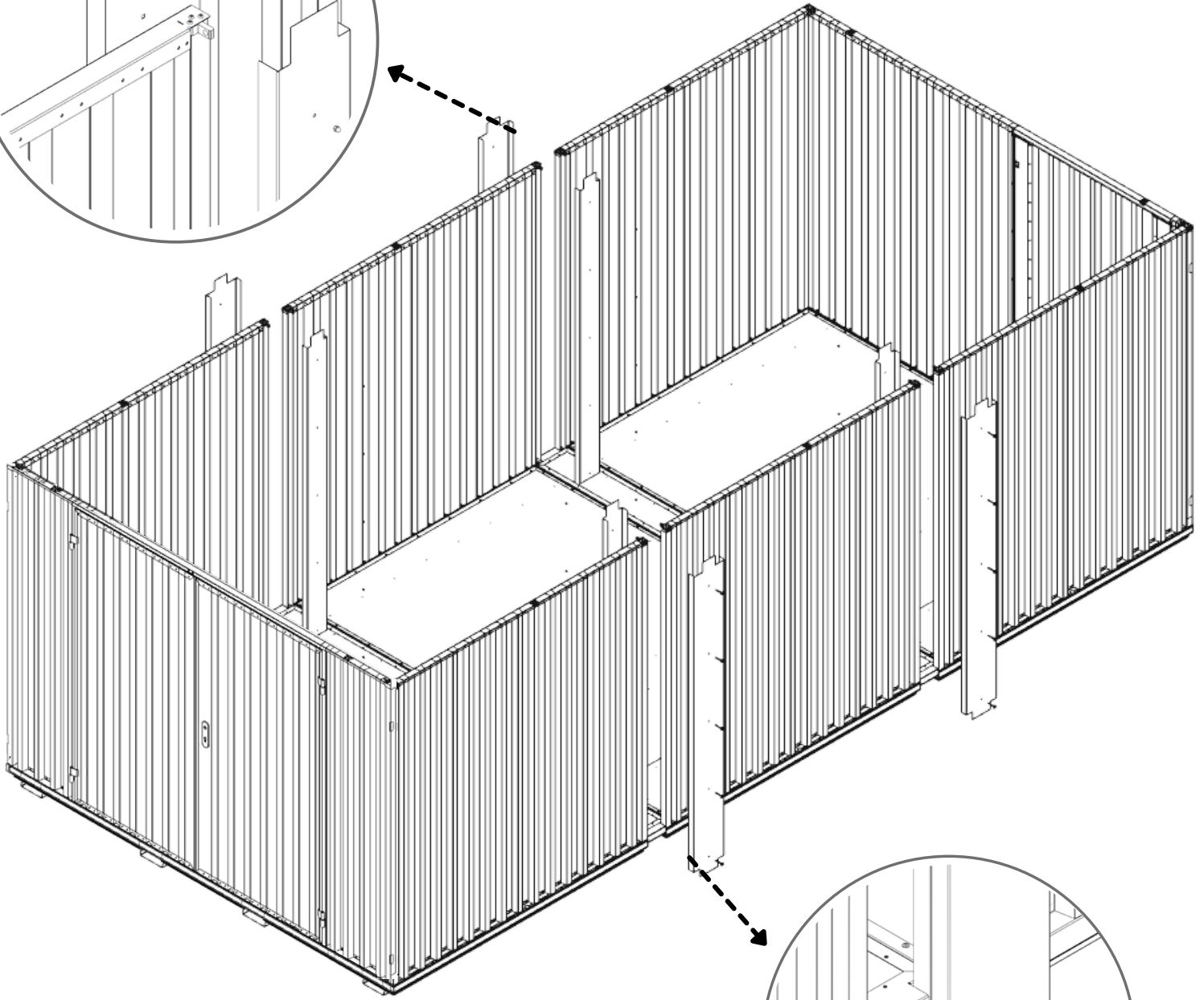
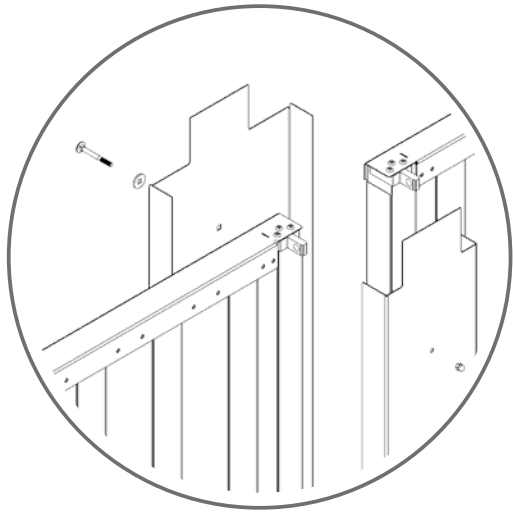

# 9.1

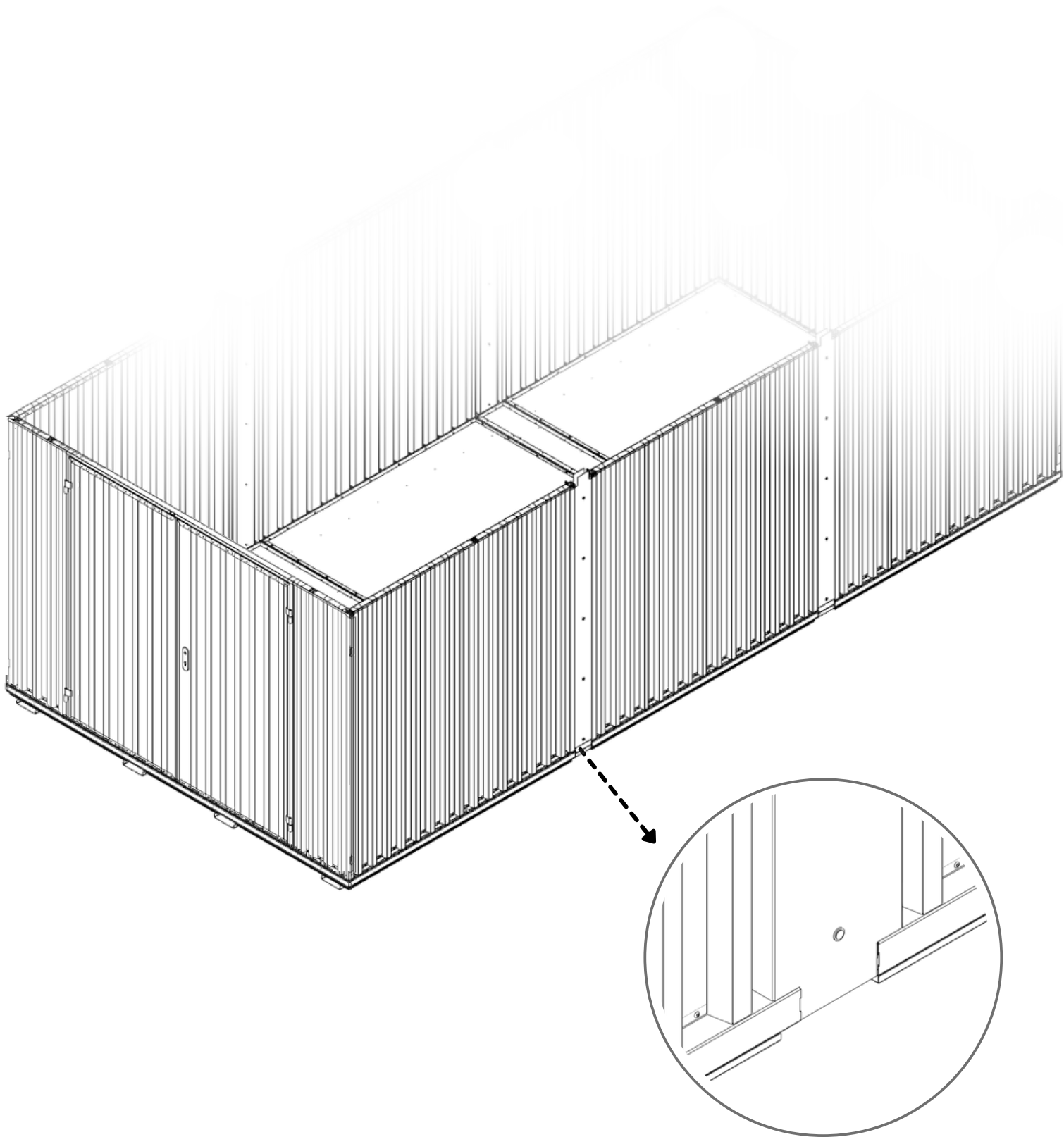



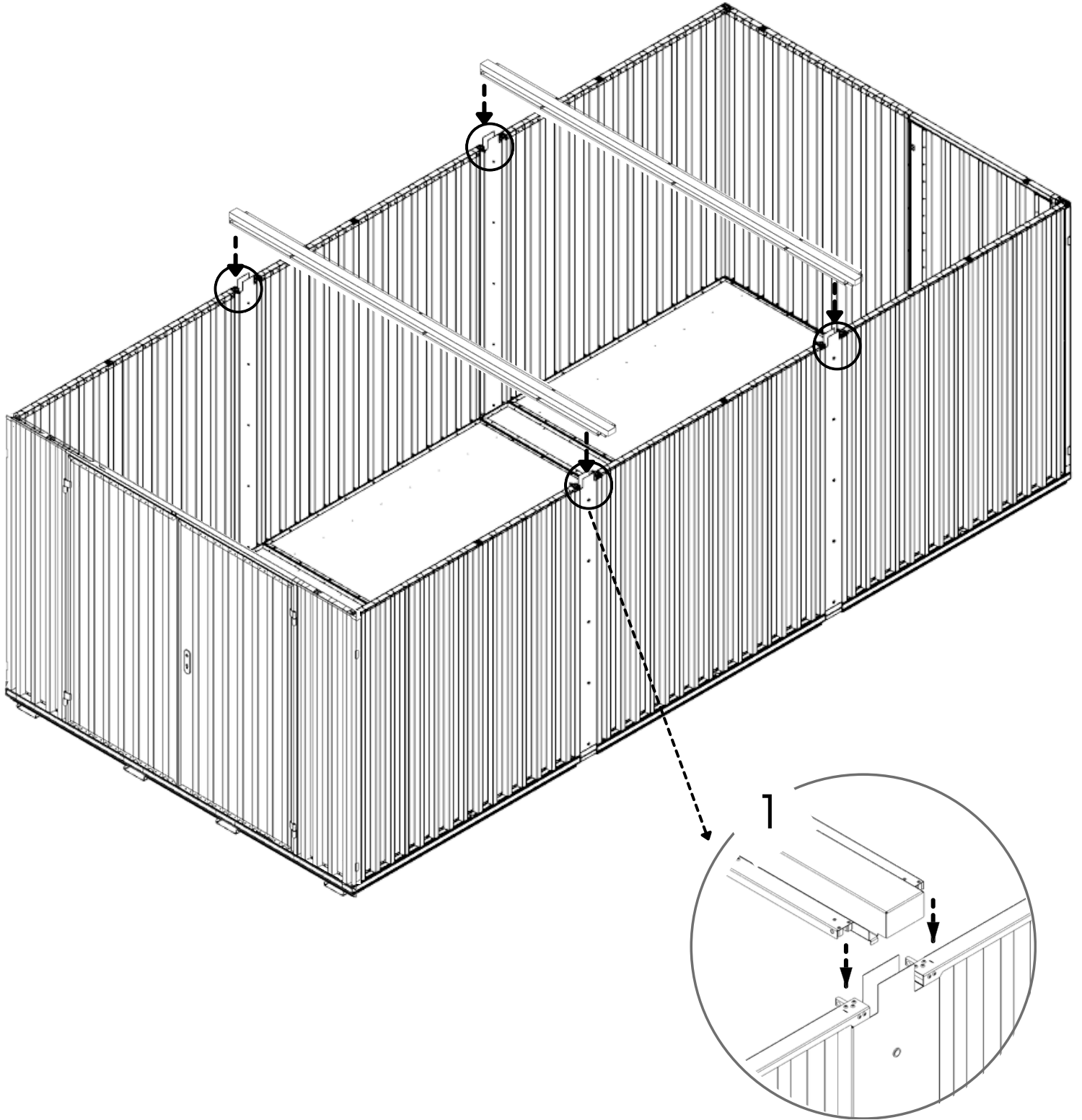



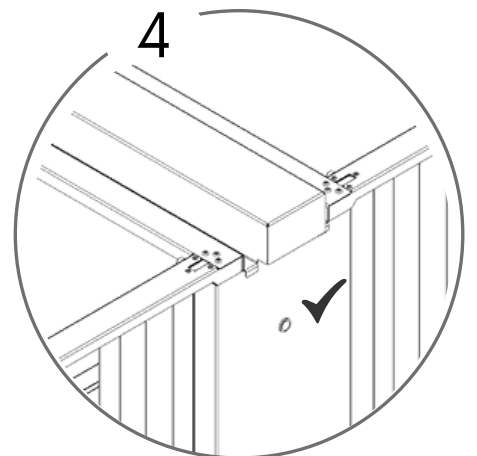
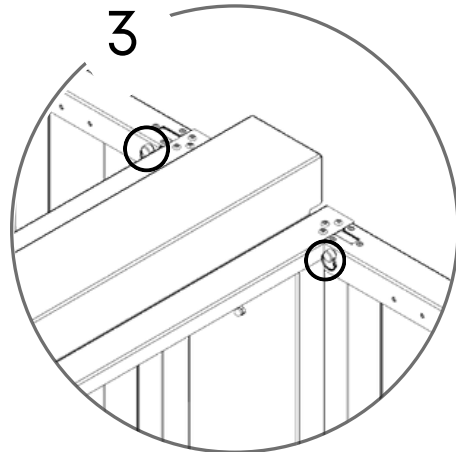
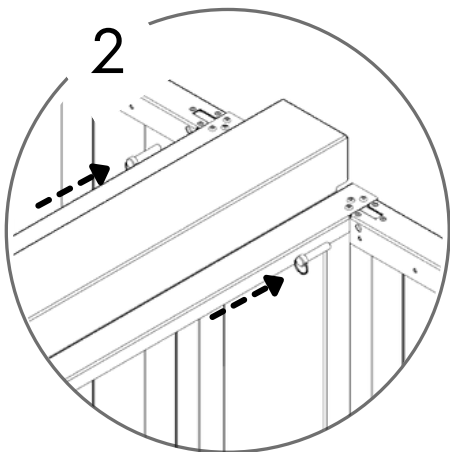
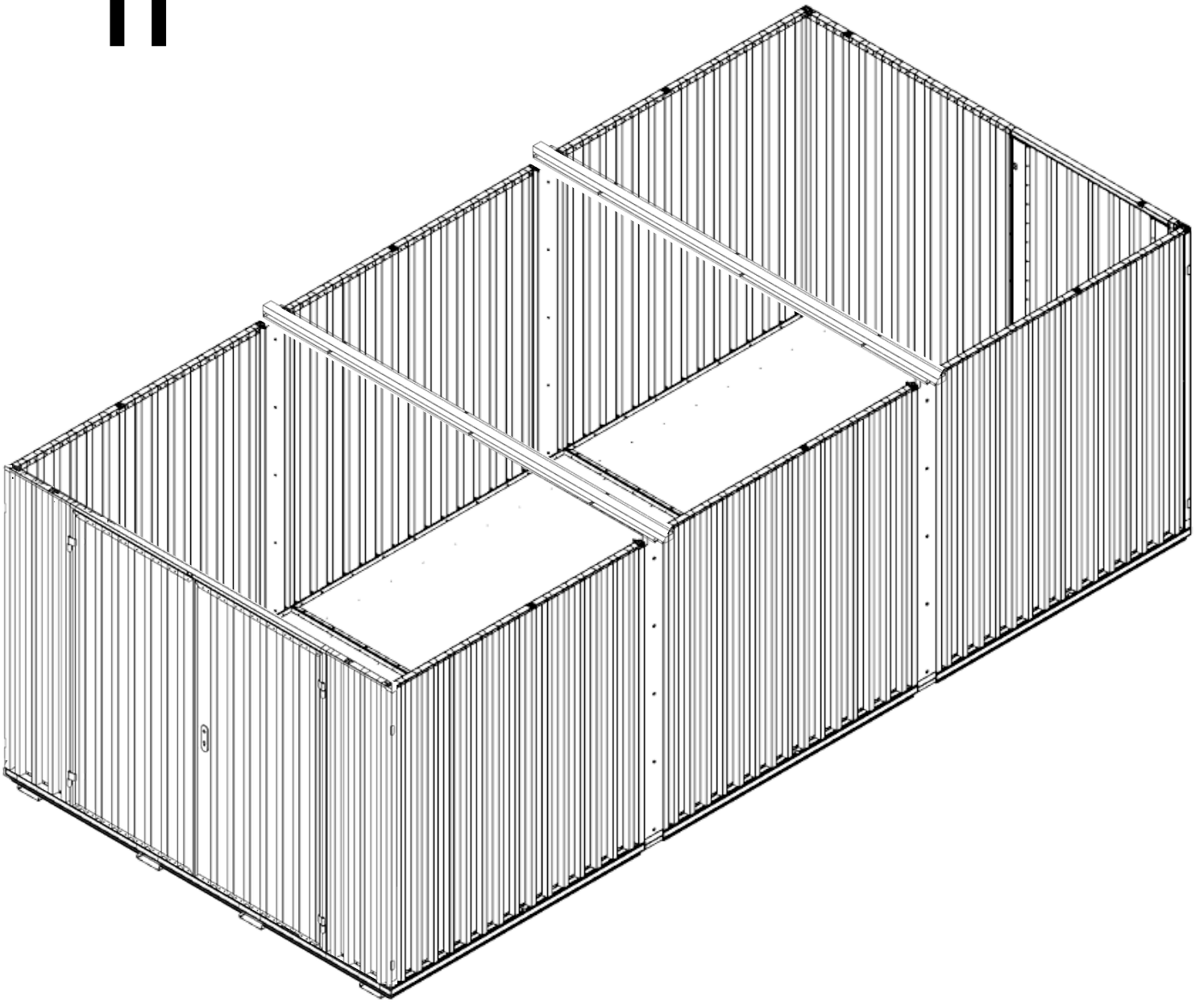

# 10



# 11





 902 KG	 1640 MM	Model Code: 3033.110.430.450 Production Tracking Code: ...../X09.1.3033.430.450	 9001	 14001	 50001			
---	--	---	---	--	--	---	---	---

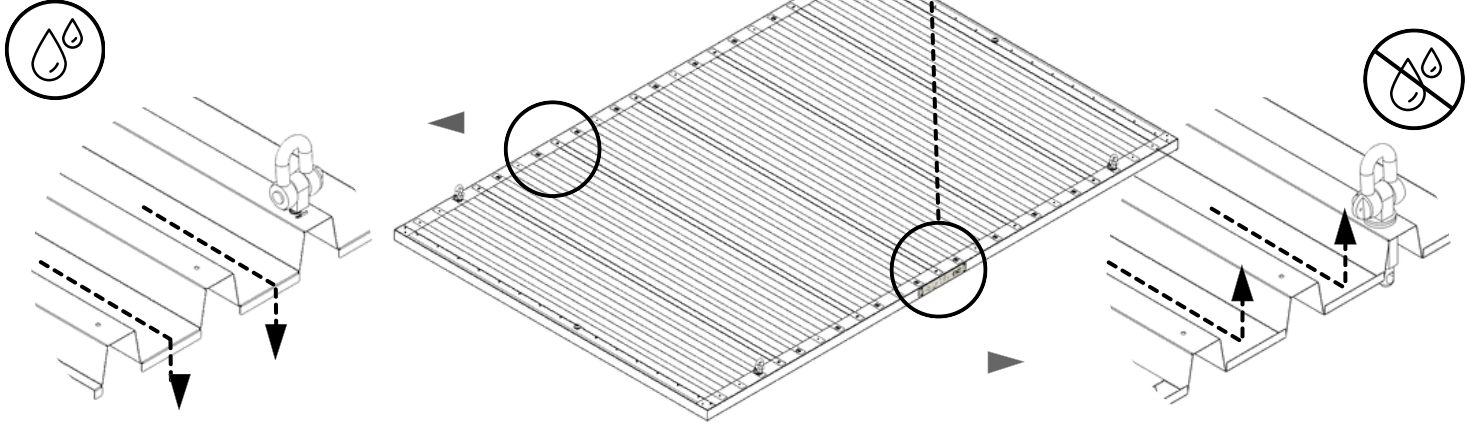

12

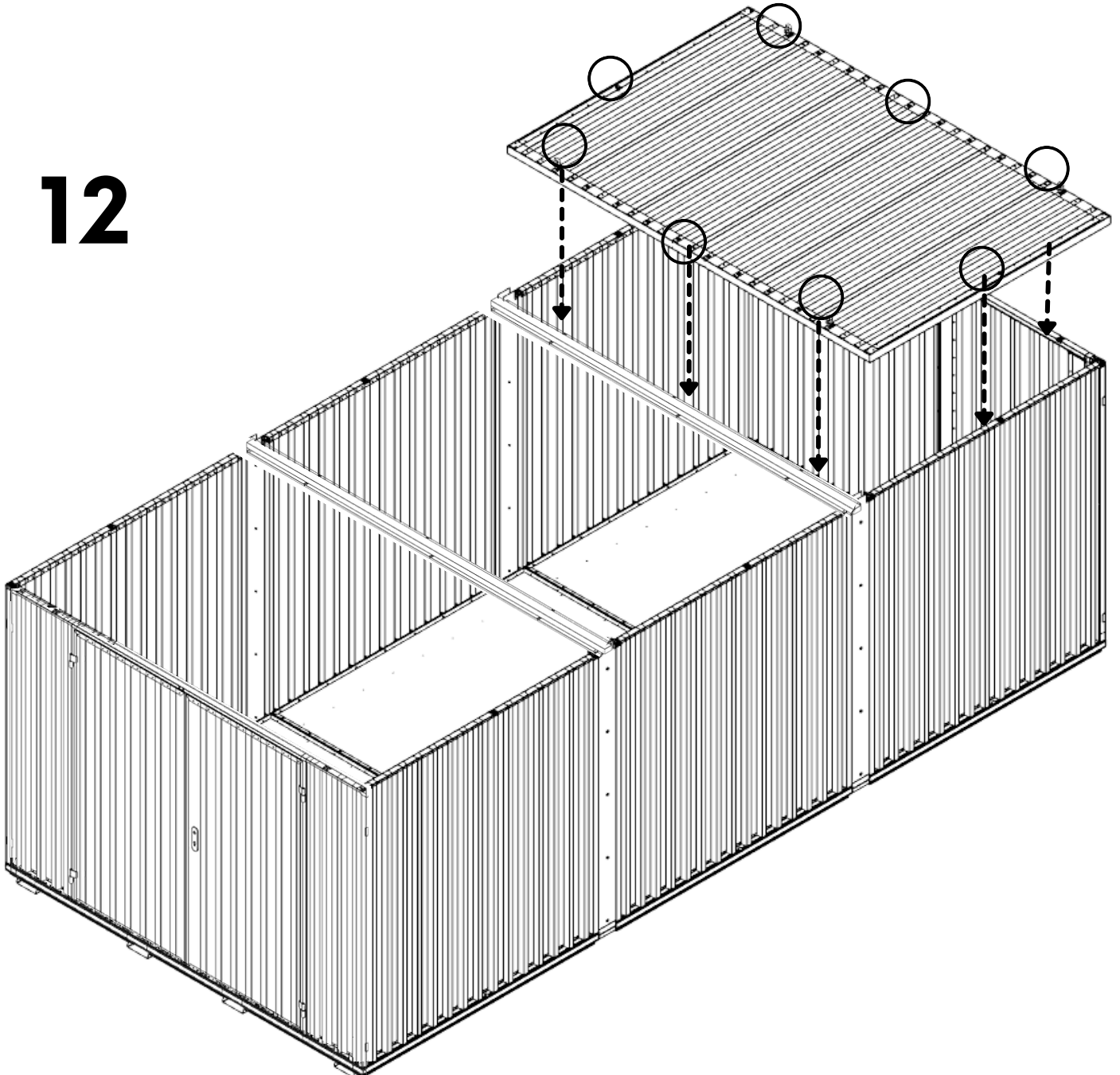



# 13

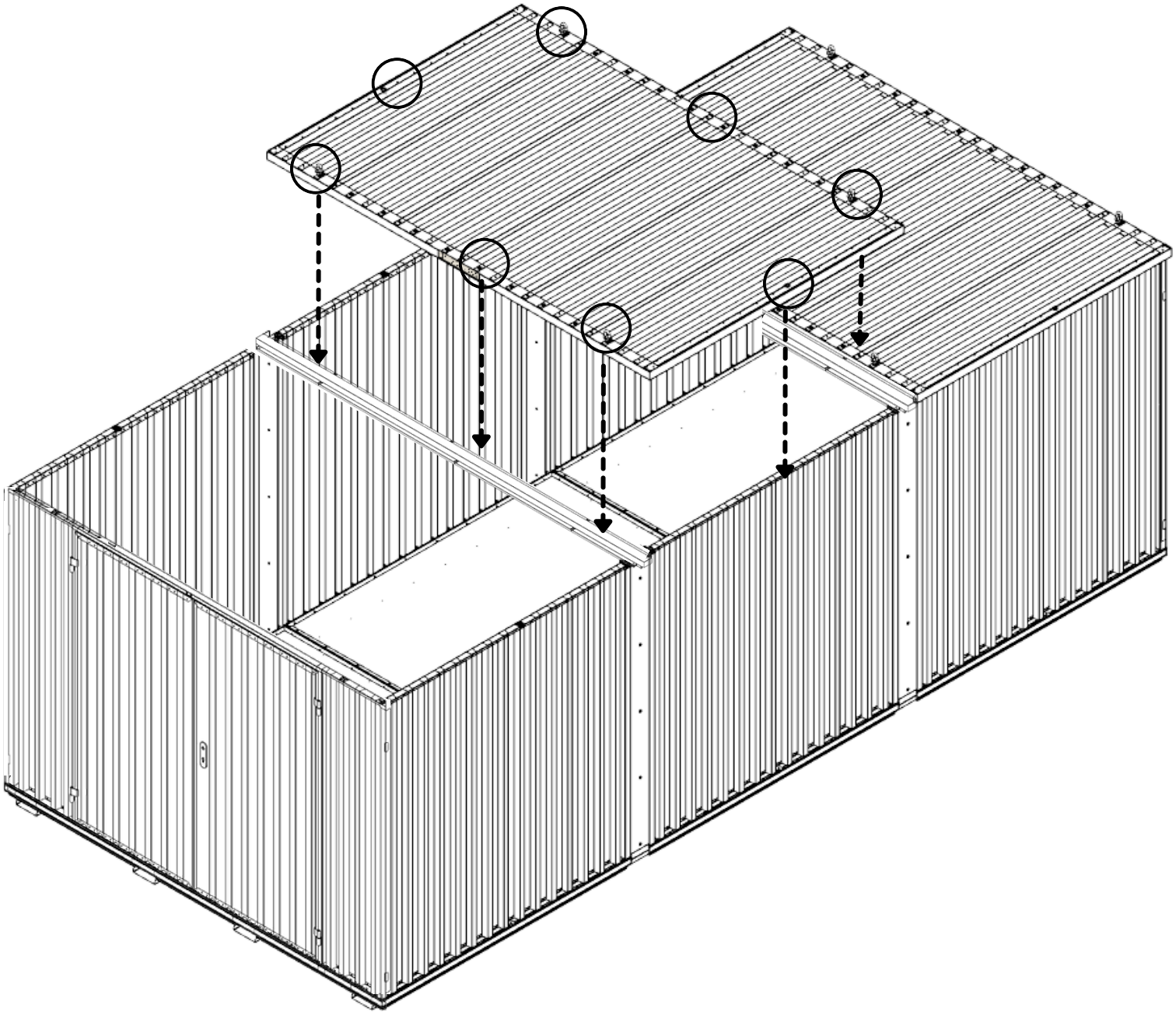

# 14

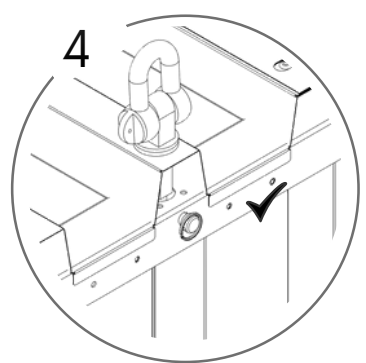
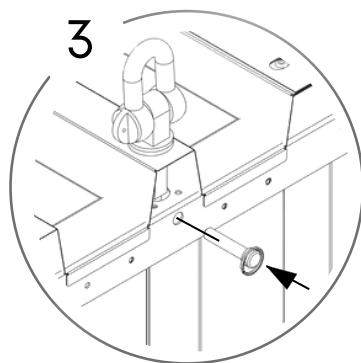
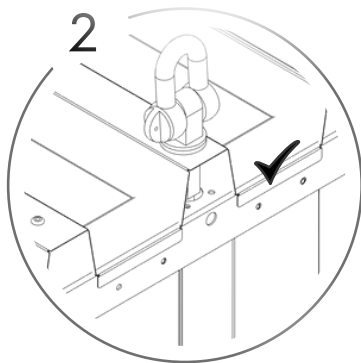
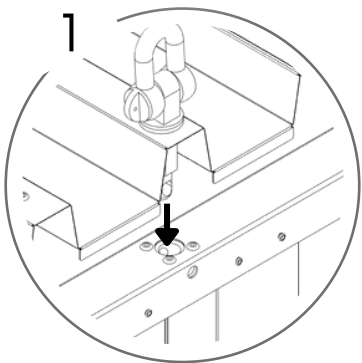
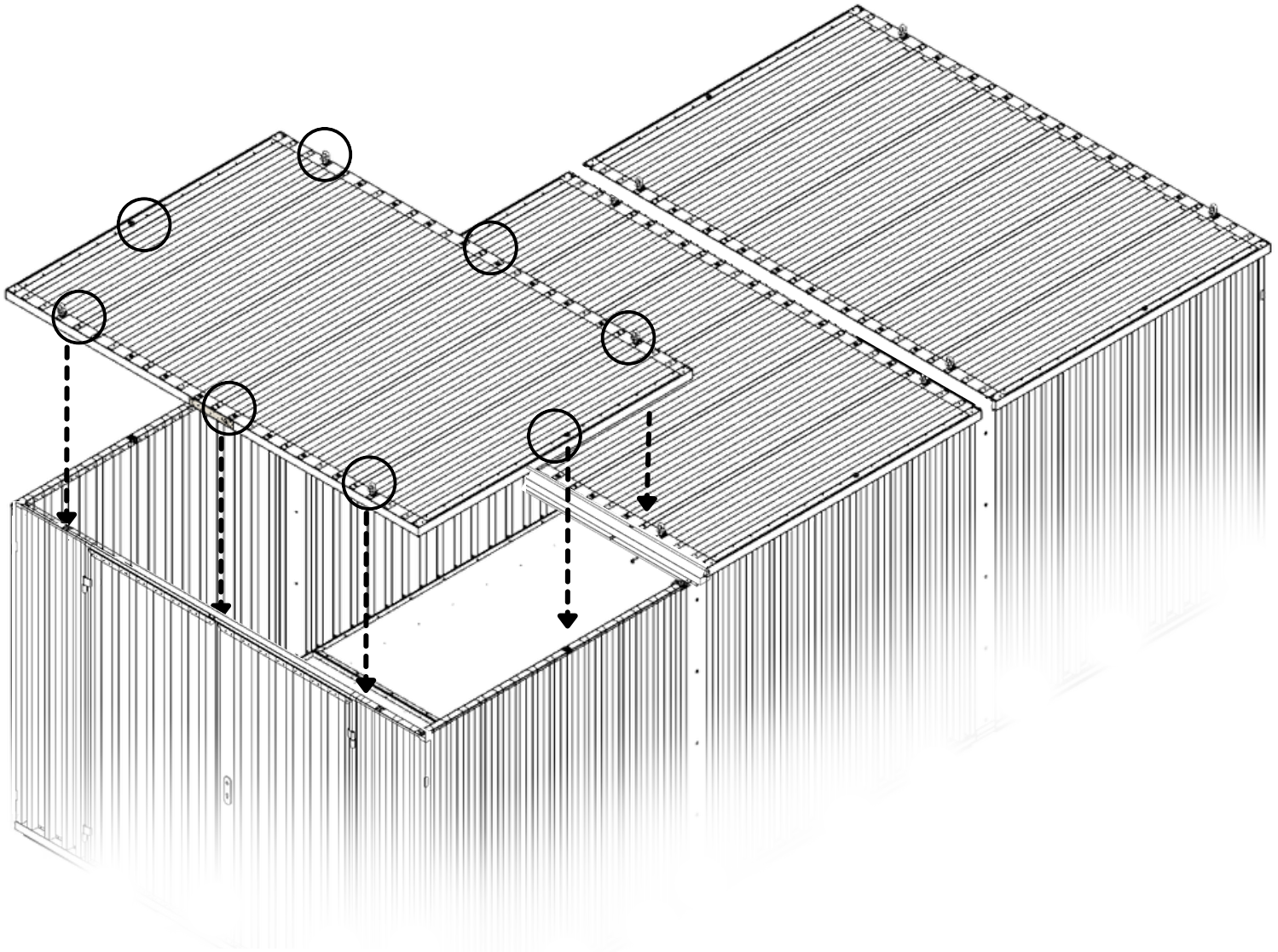

# 15

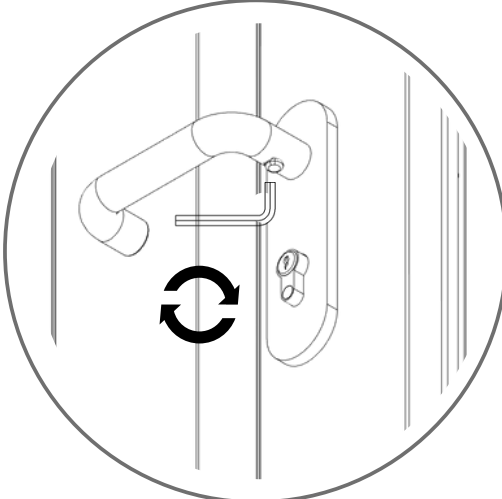
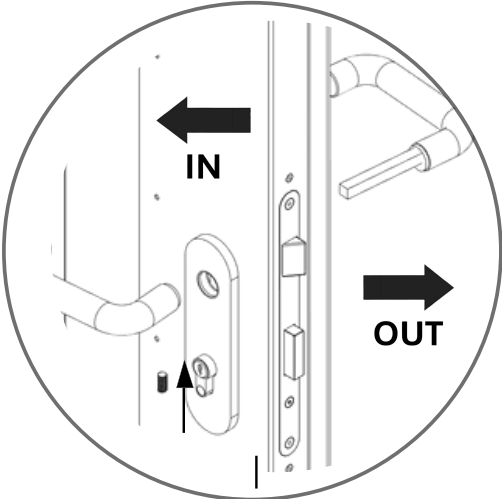
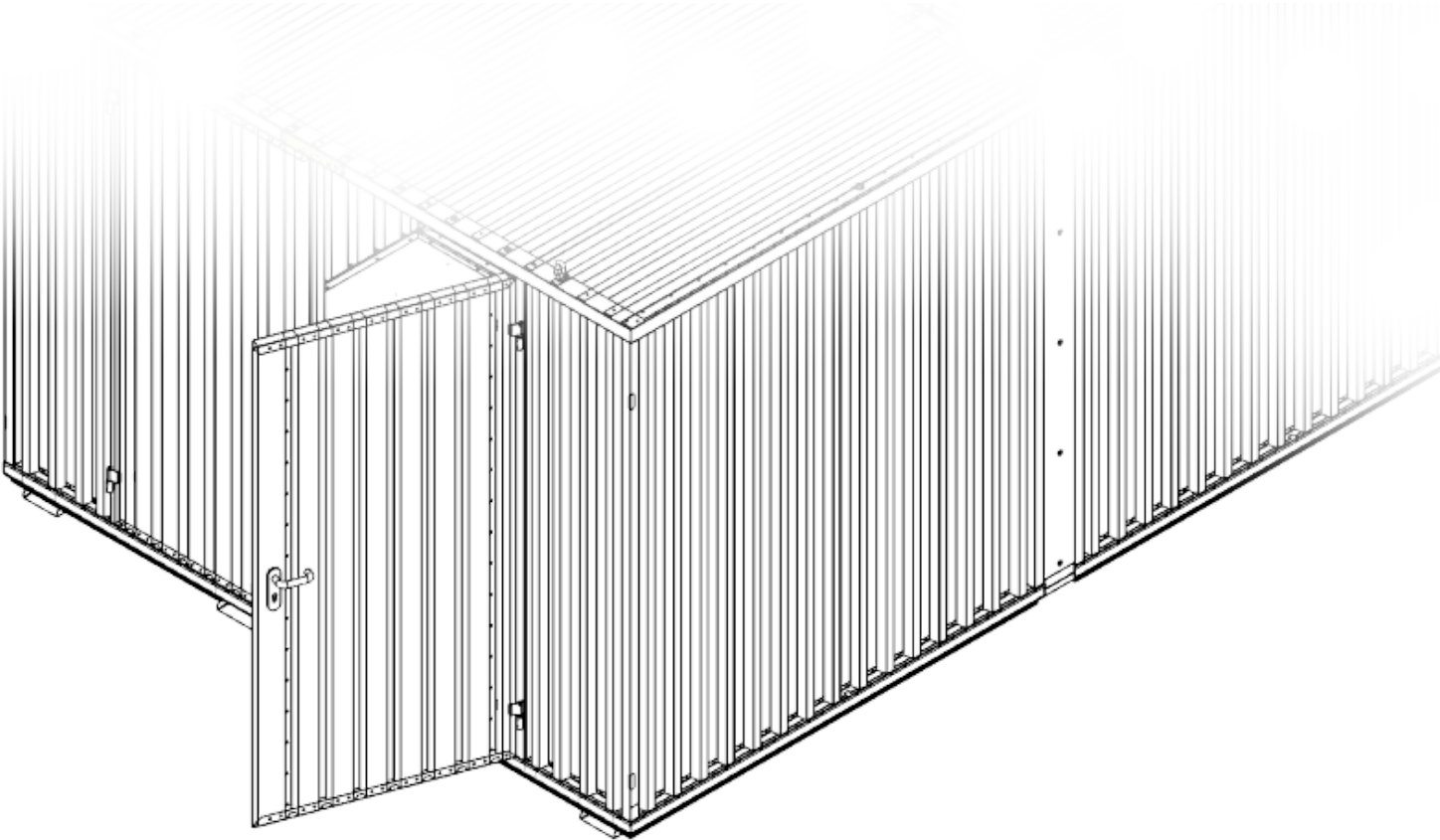

16

