

PRODUCT CODE:50.110.430

prefabase
Quick Build Solutions

Instructions and User Guide

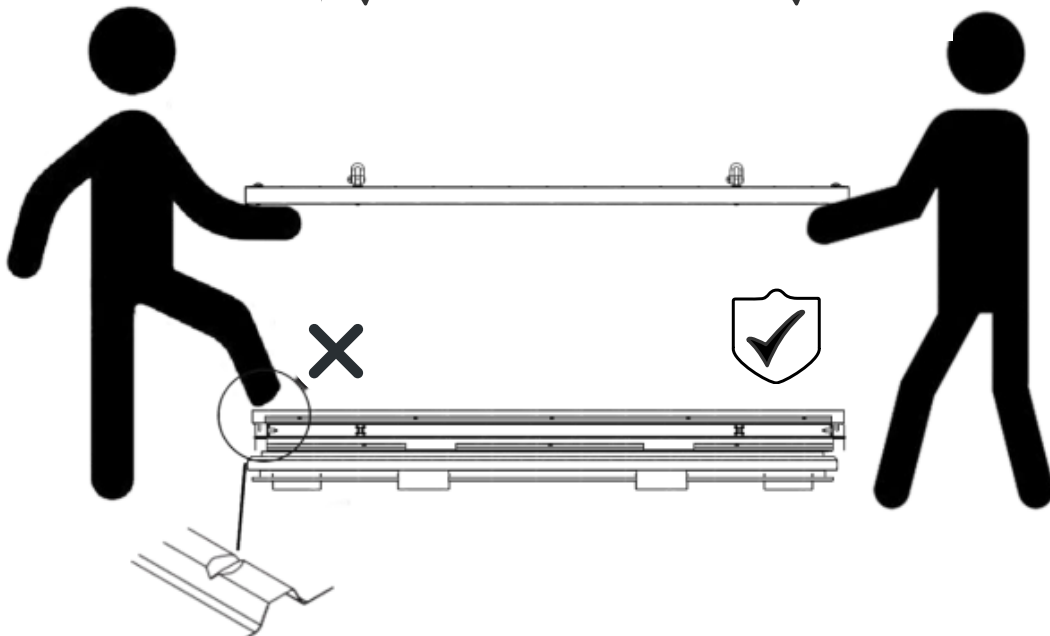
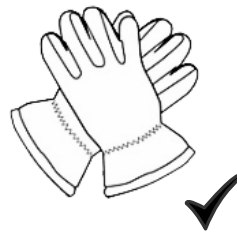
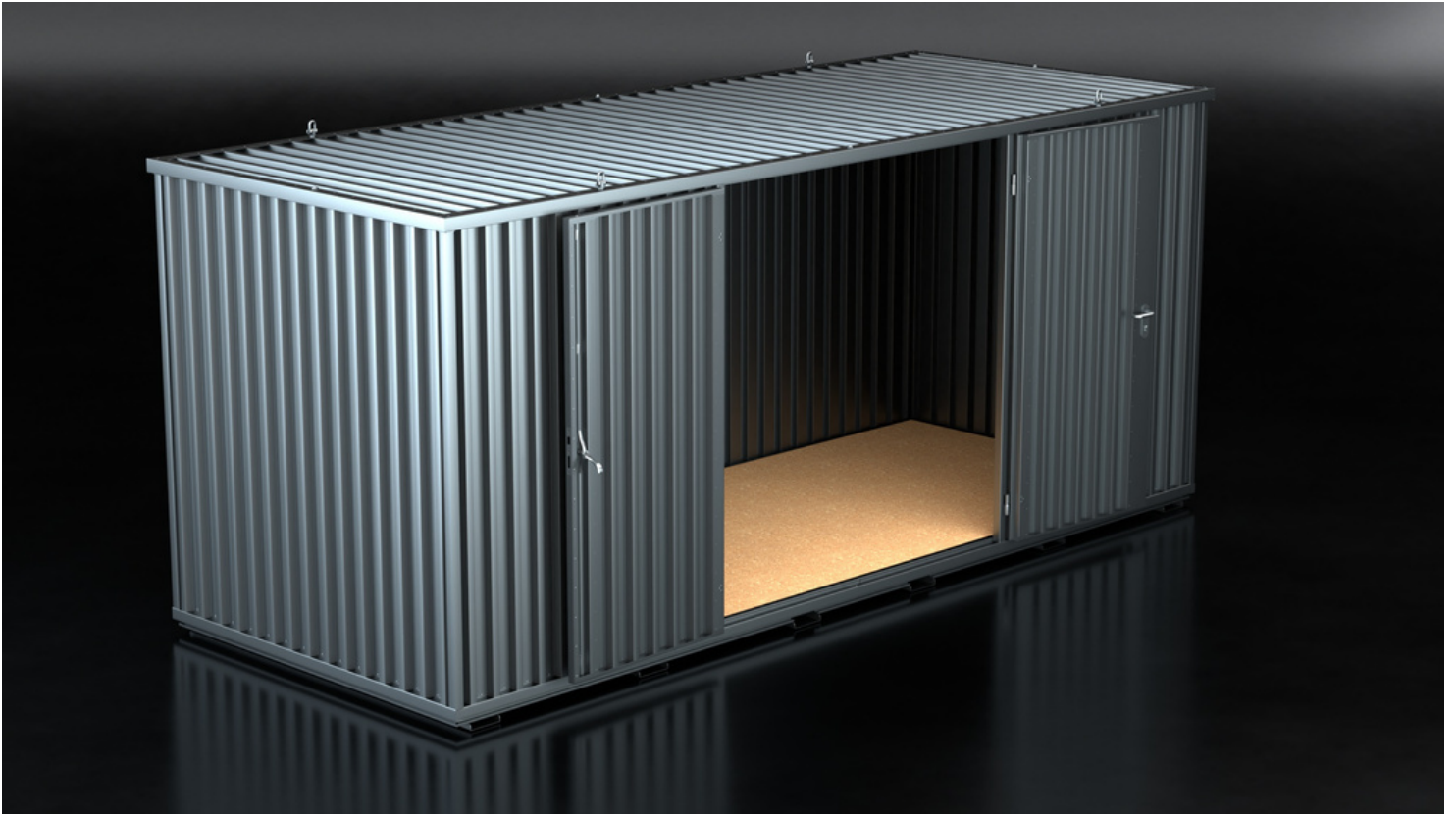

50.0110
1x

50.0510
1x

50.0410
1x

50.0430
1x

0310
2x

61.101
4x

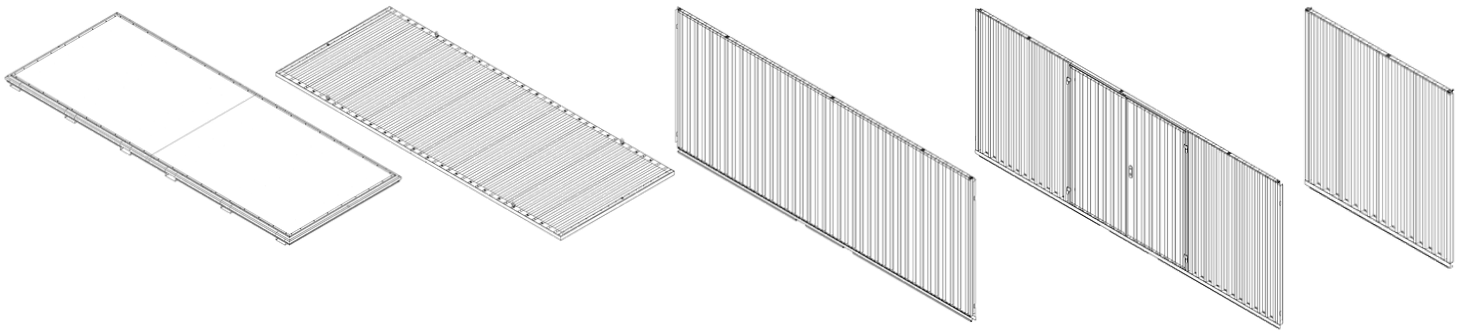

12x

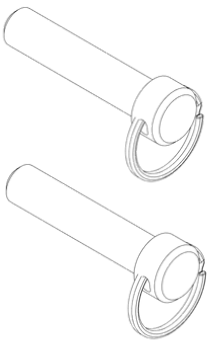

1x

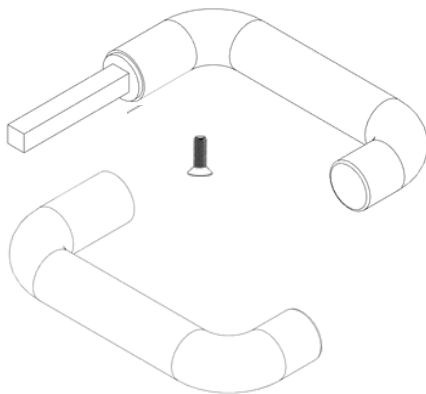

1x

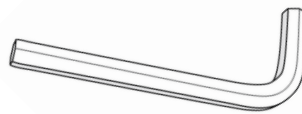

1x



1

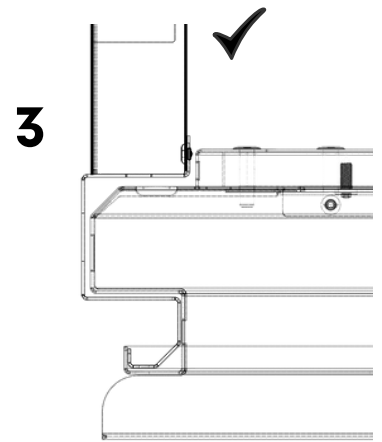
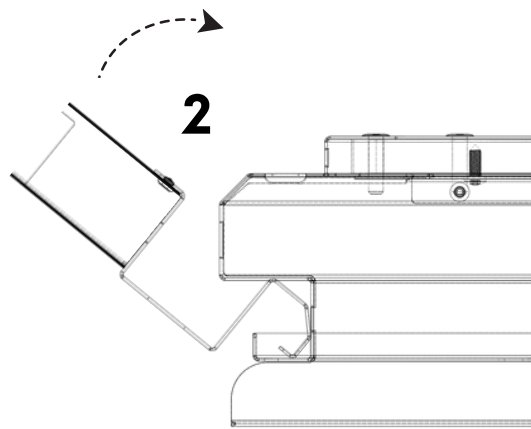
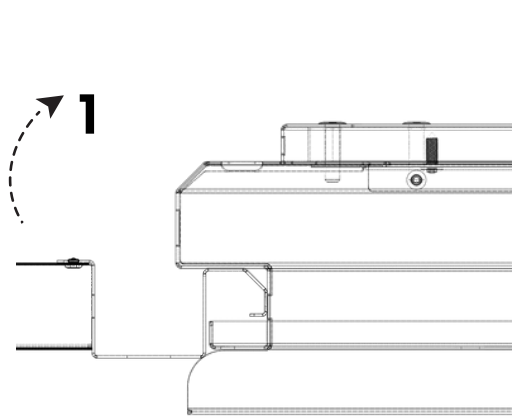
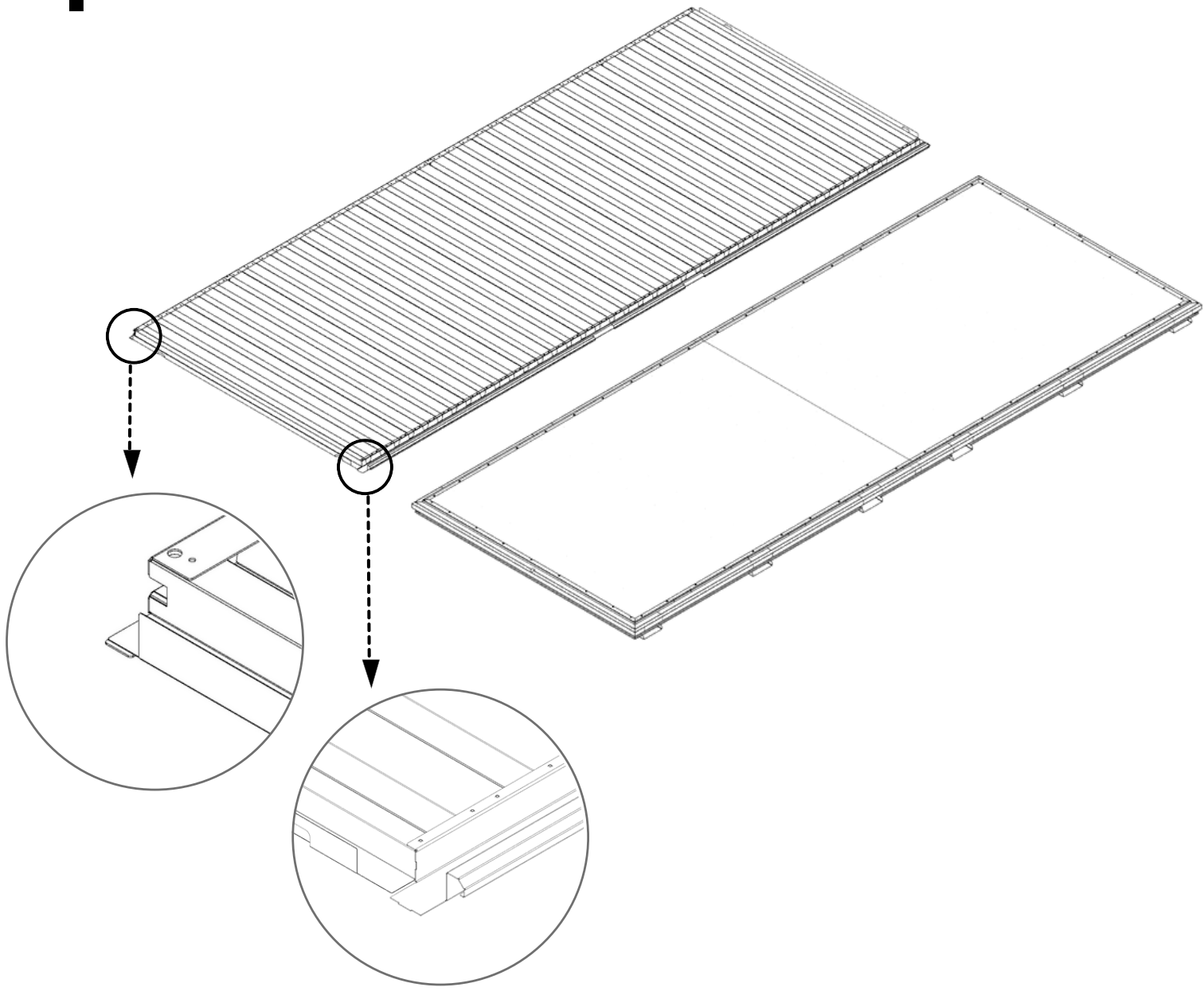

2

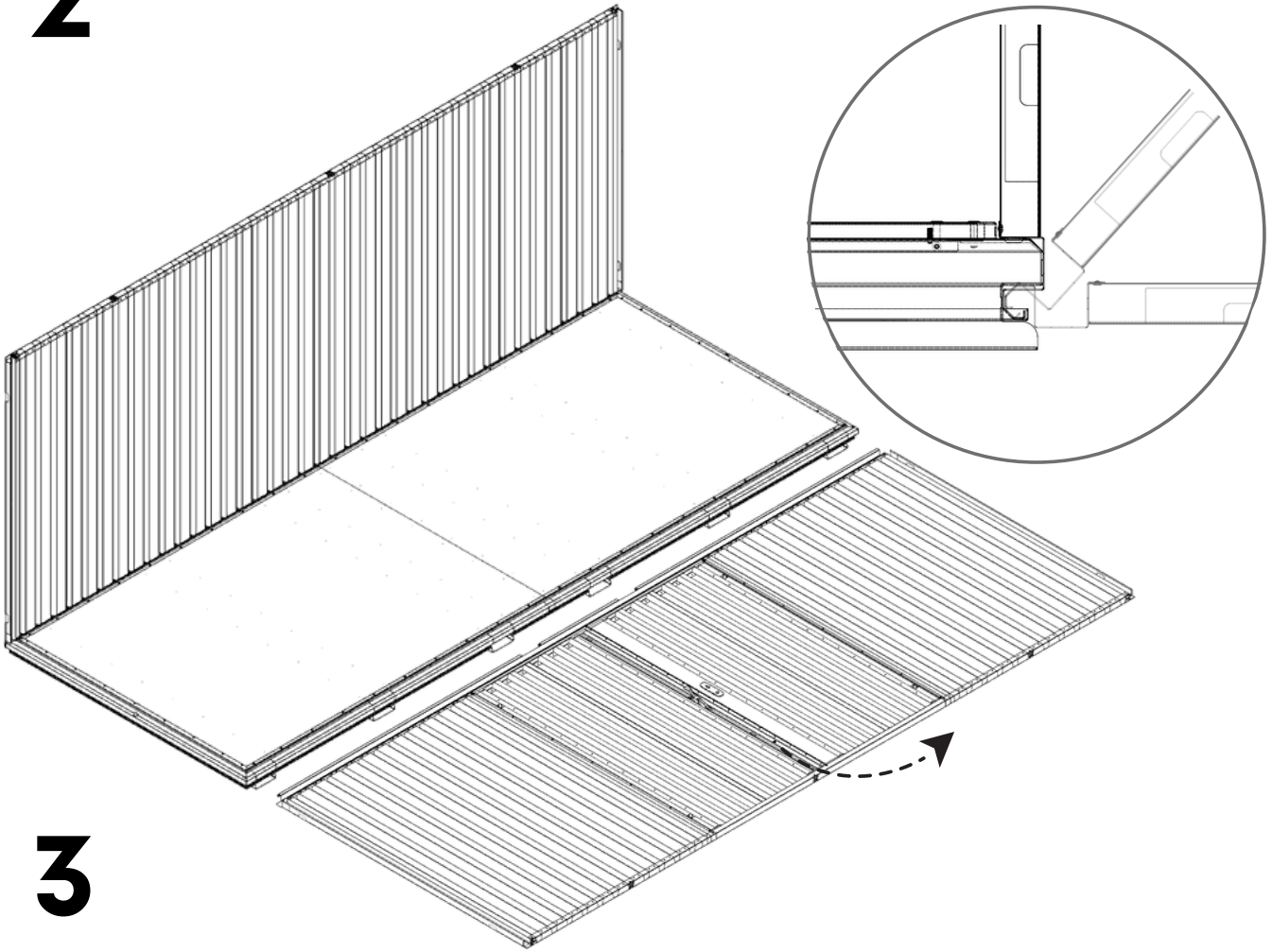

3

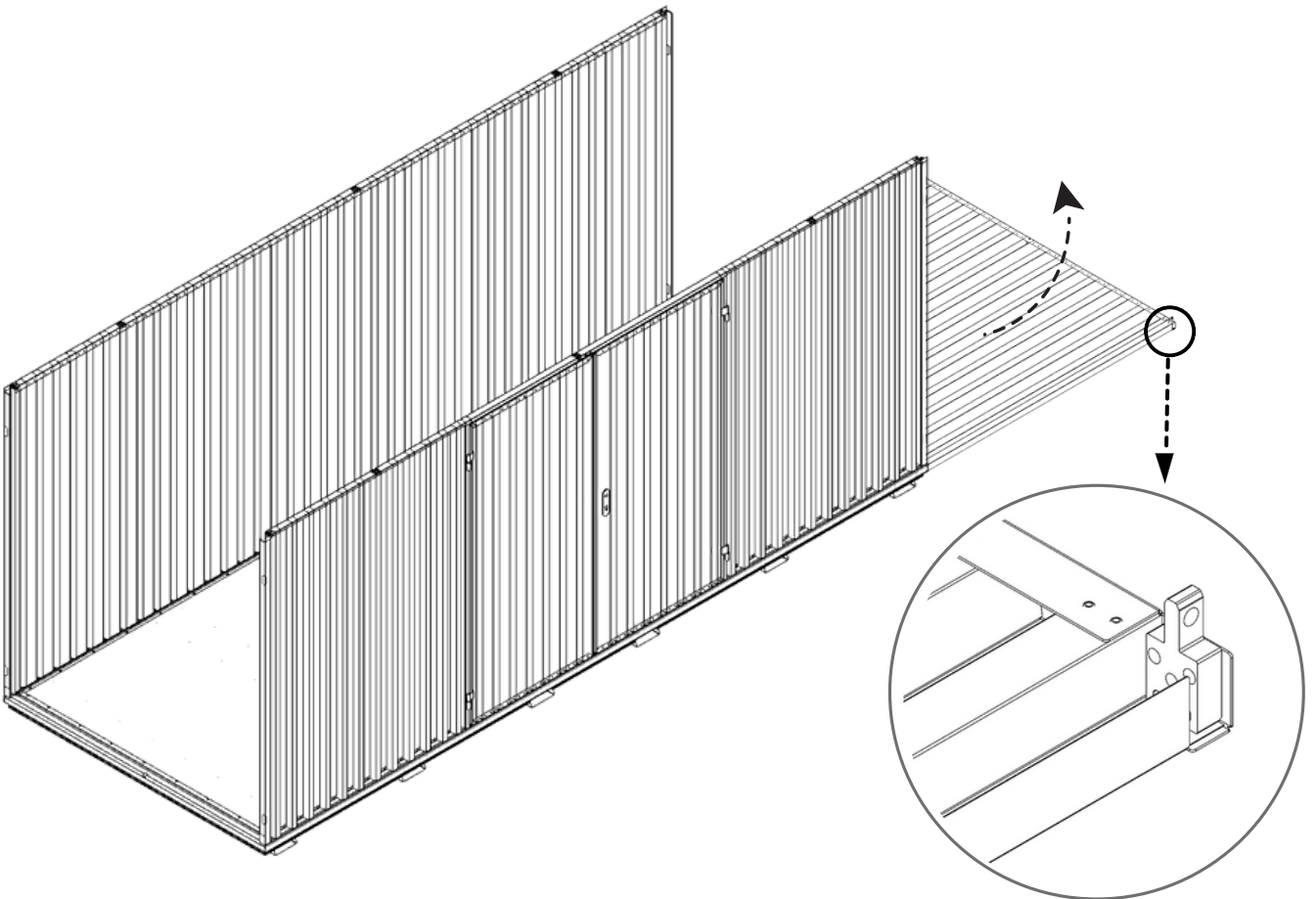

3.1

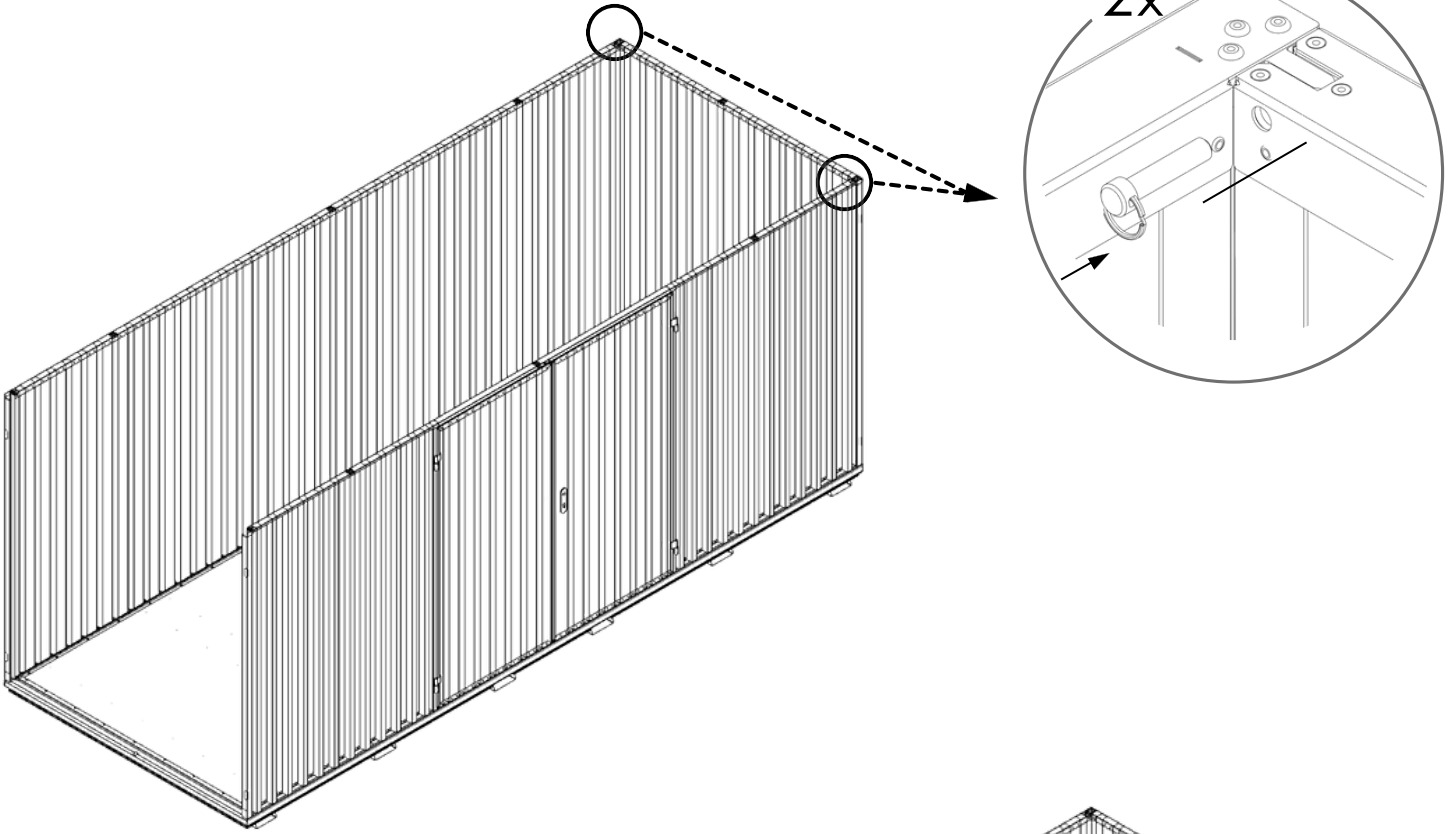



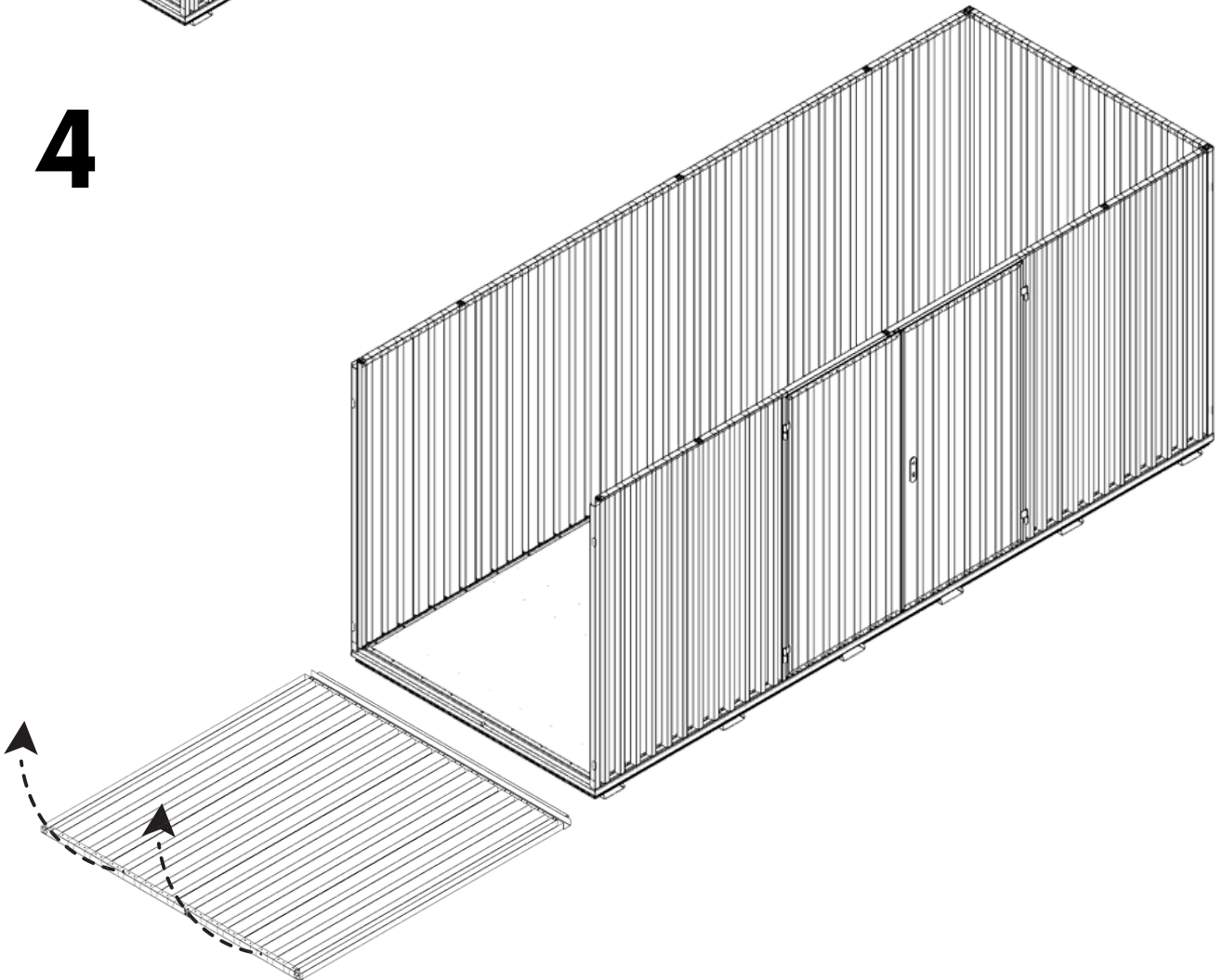



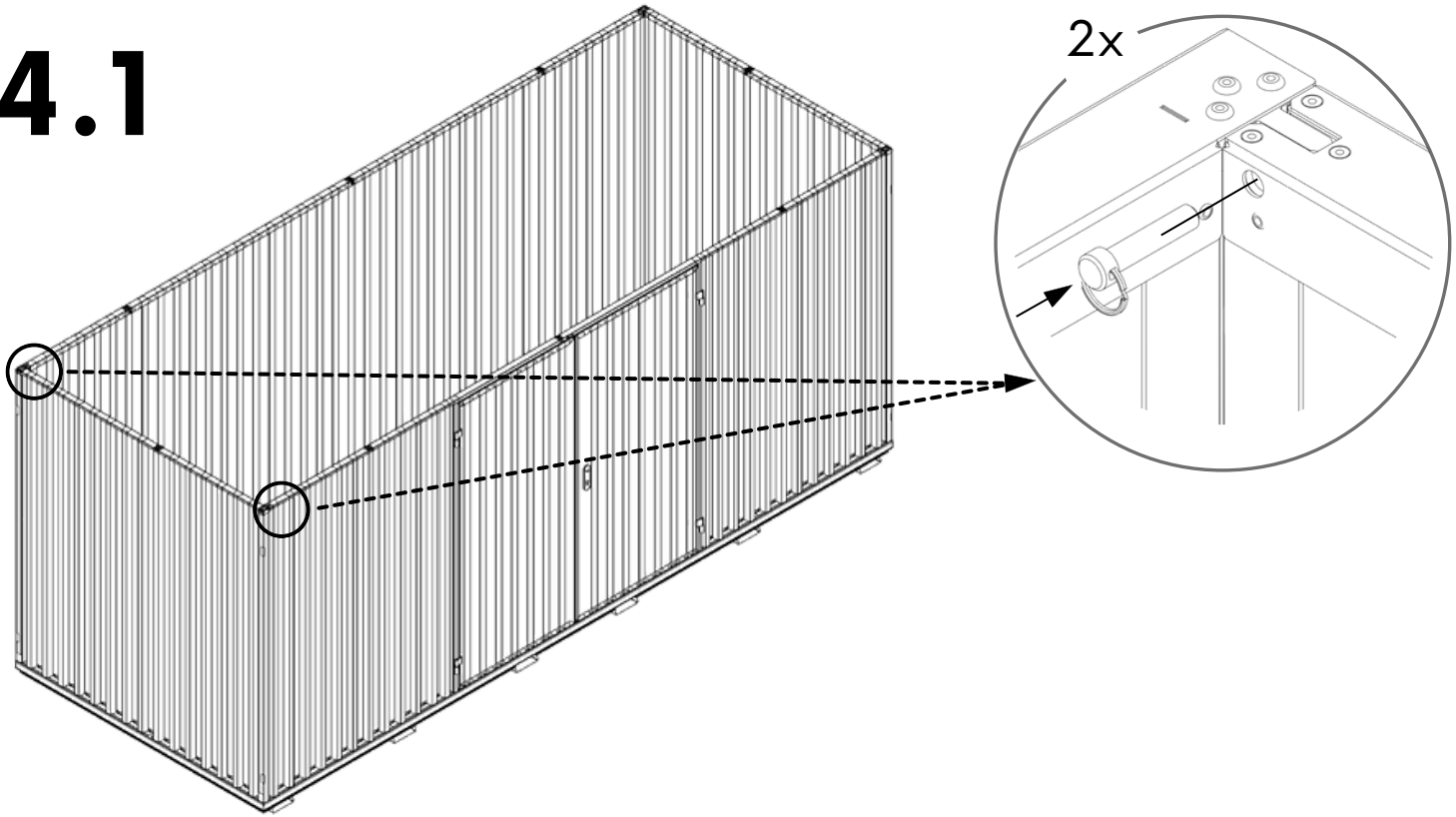

4



4.1



 504 KG	 1640 MM	Model Code: 50.110.430 Production Tracking Code: /X09.1.50.430  9001  14001  50001	 	
---	--	--	---	---

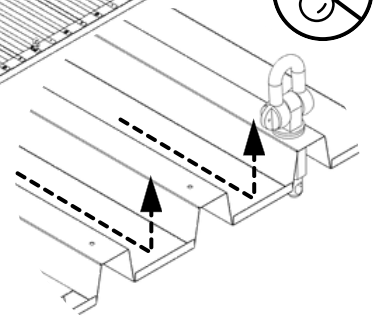
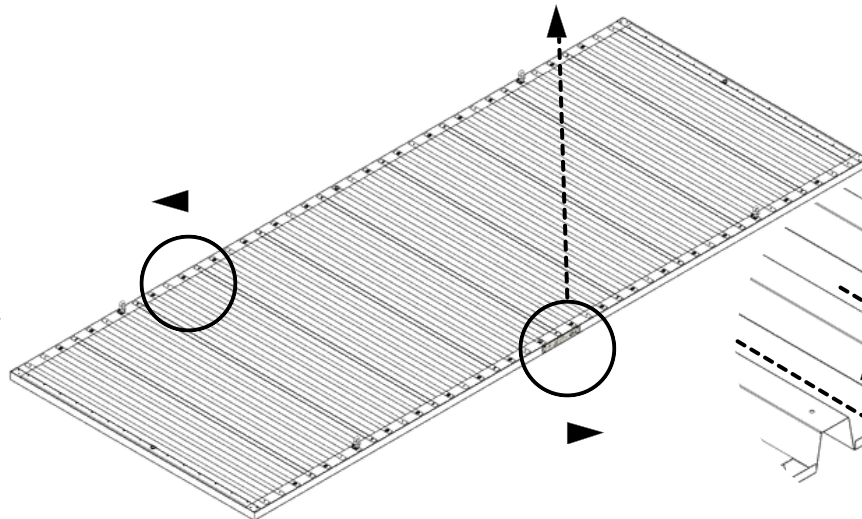
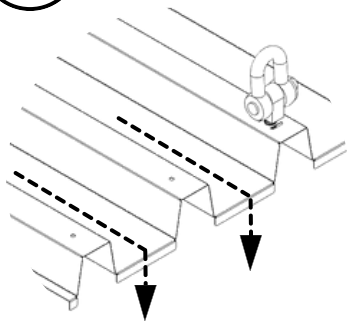

5

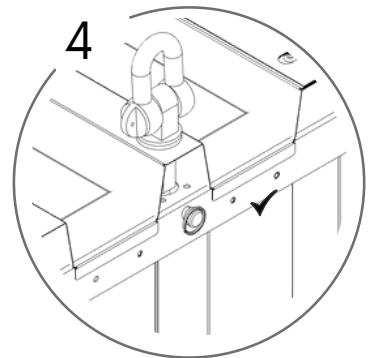
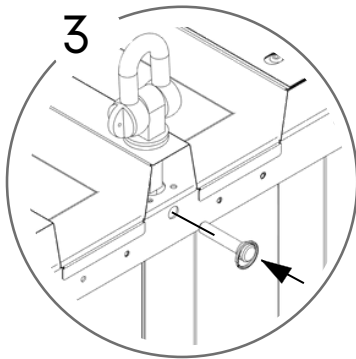
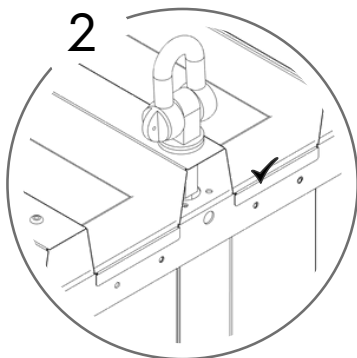
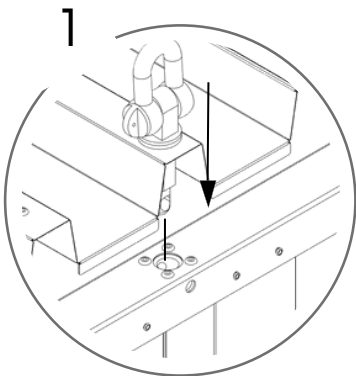
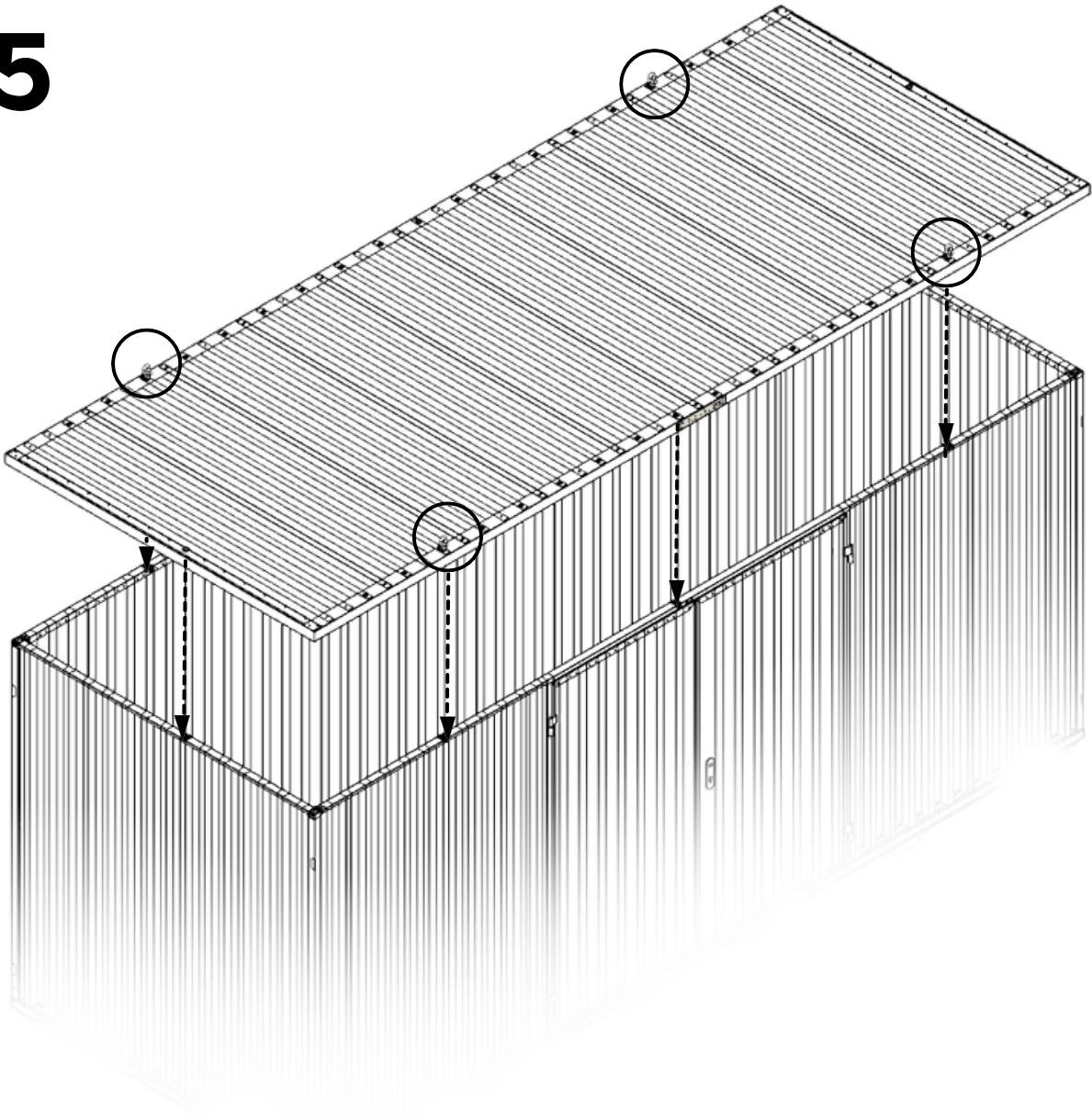

6

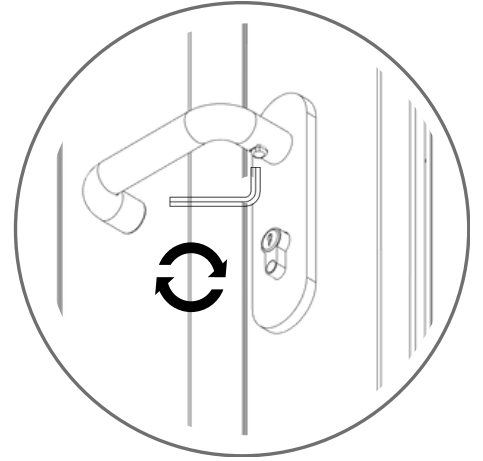
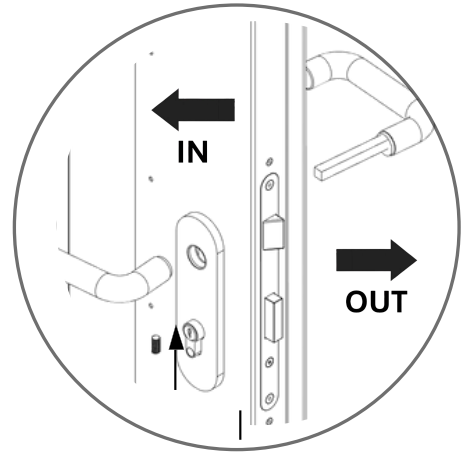
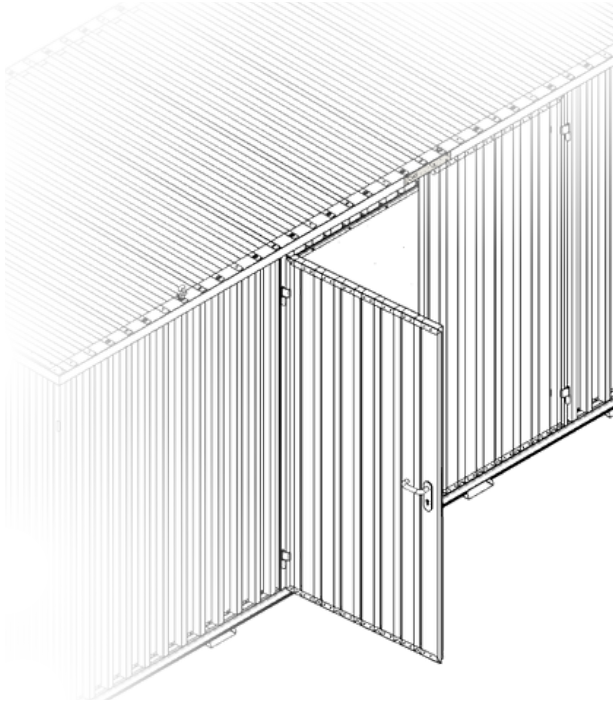

7

