

PRODUCT CODE:60.110.450

prefabase
Quick Build Solutions

Instructions and User Guide

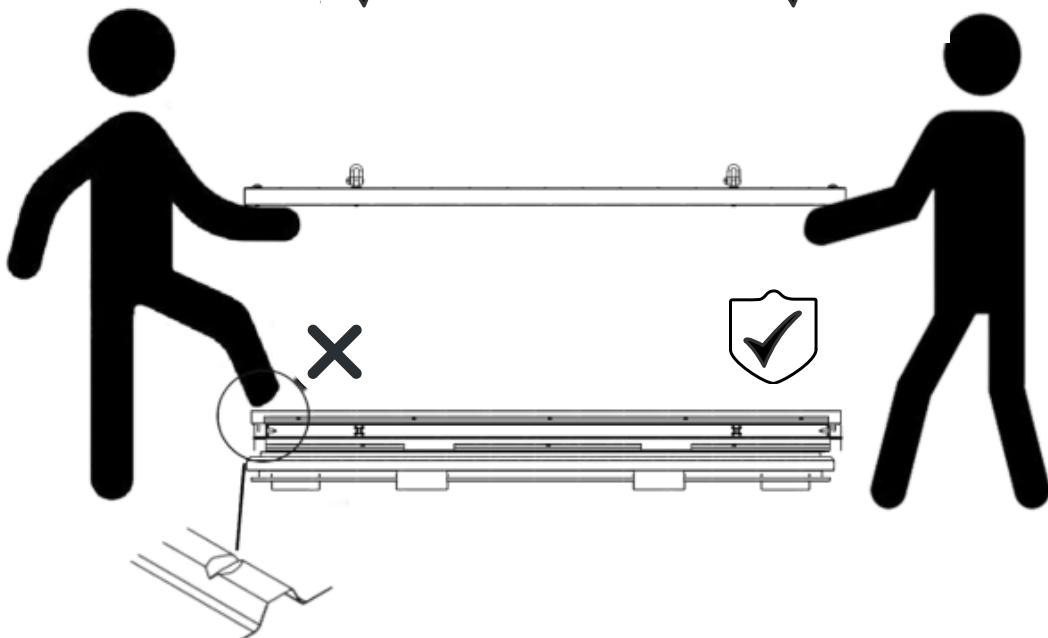
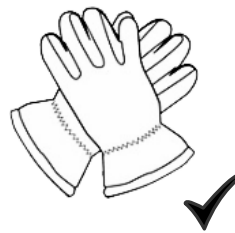

60.0110
1x

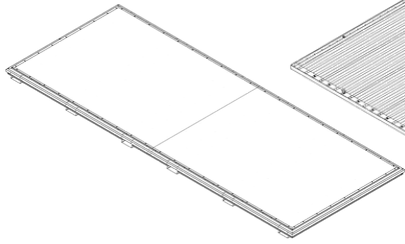

60.0510
1x

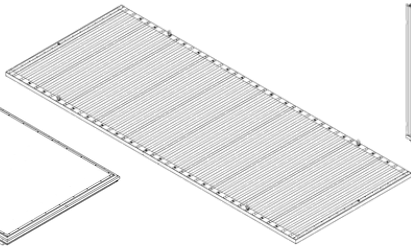

60.0410
1x

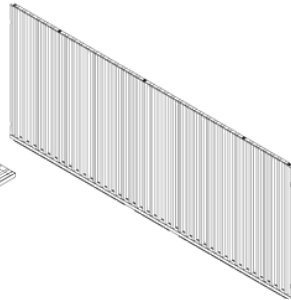

60.0450
1x

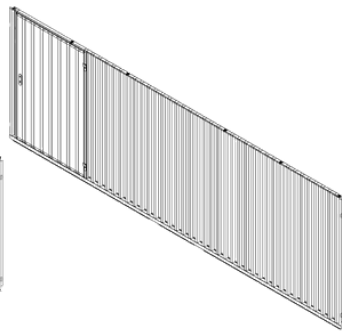

0310
2x

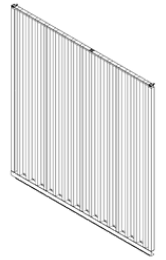

61.101
4x



14x

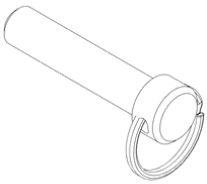

1x

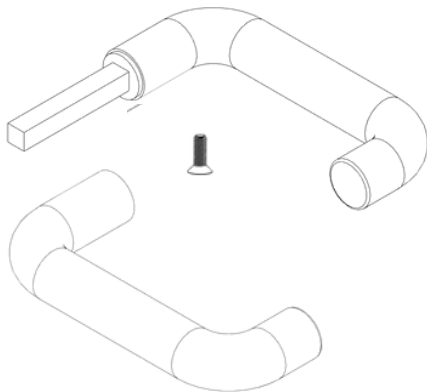

1x

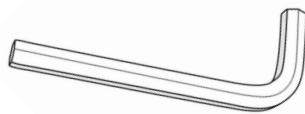

1x



1

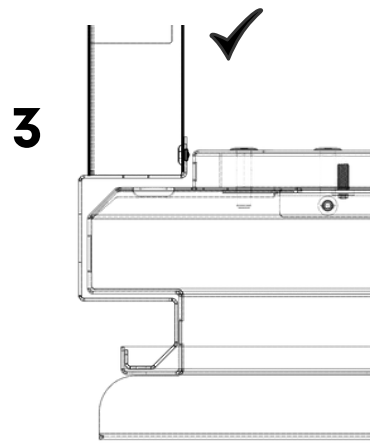
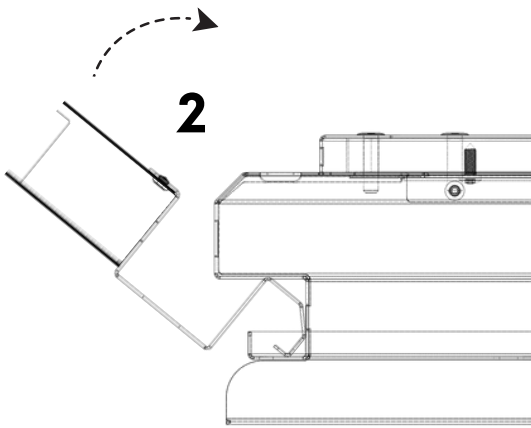
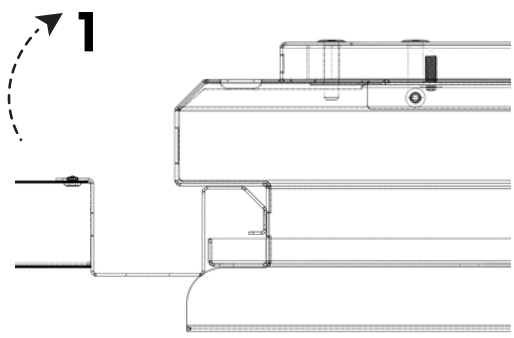
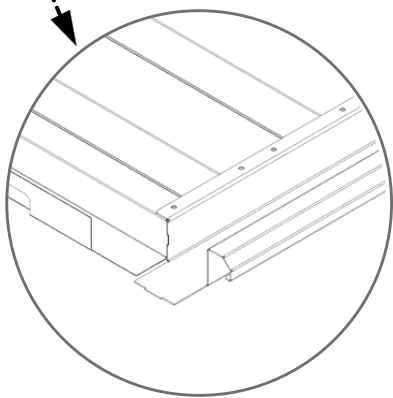
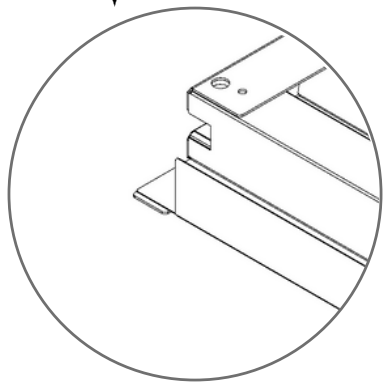
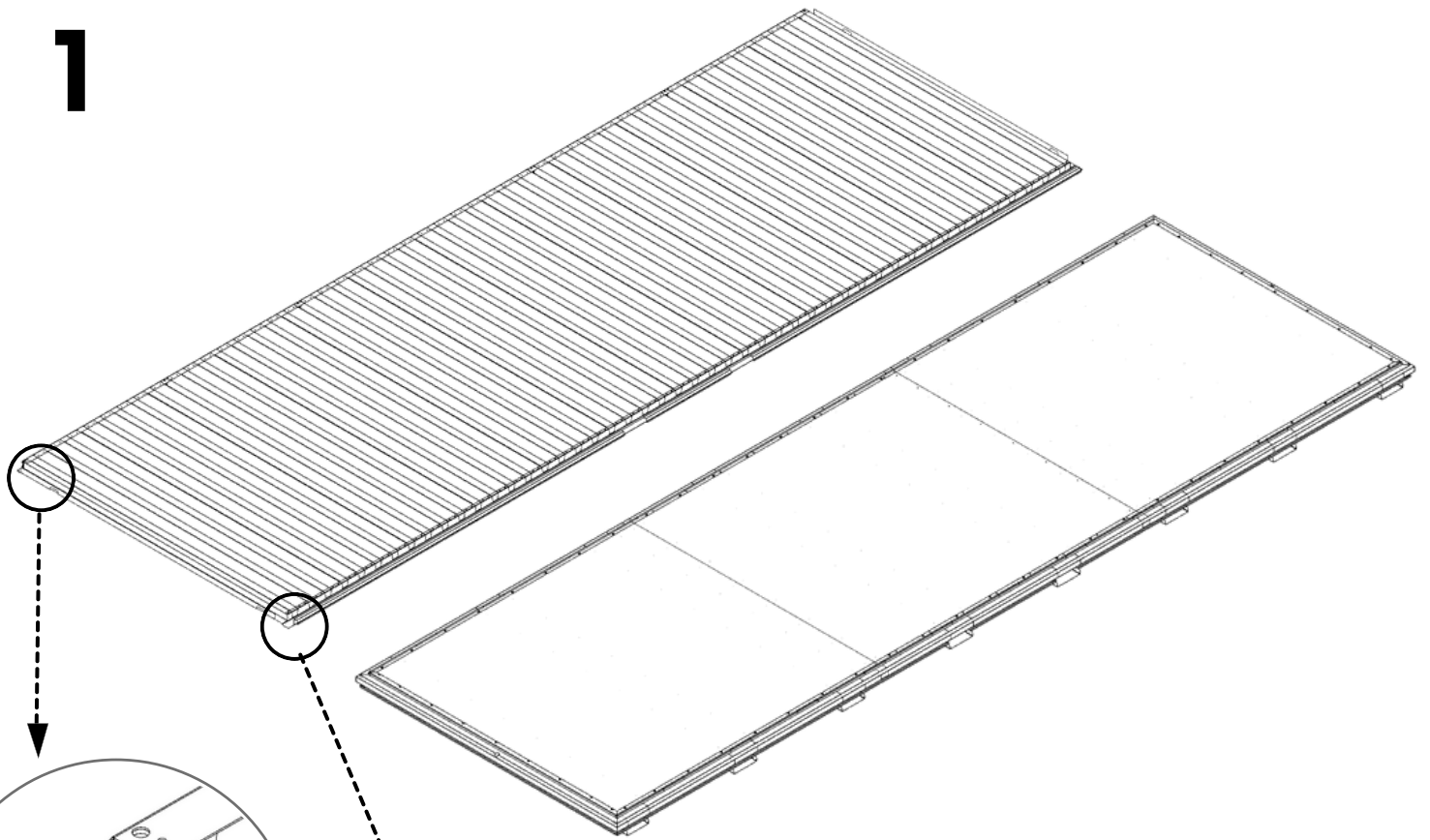

2

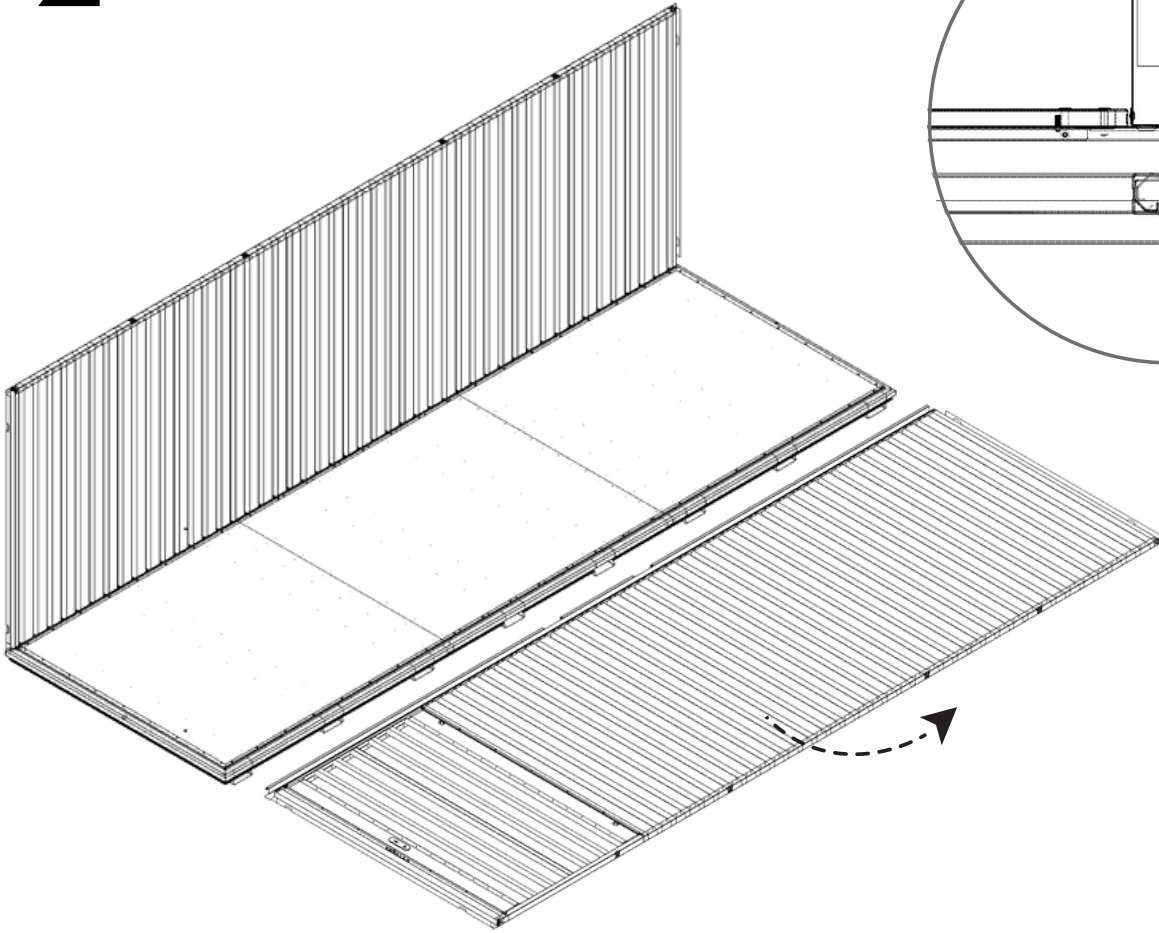

3

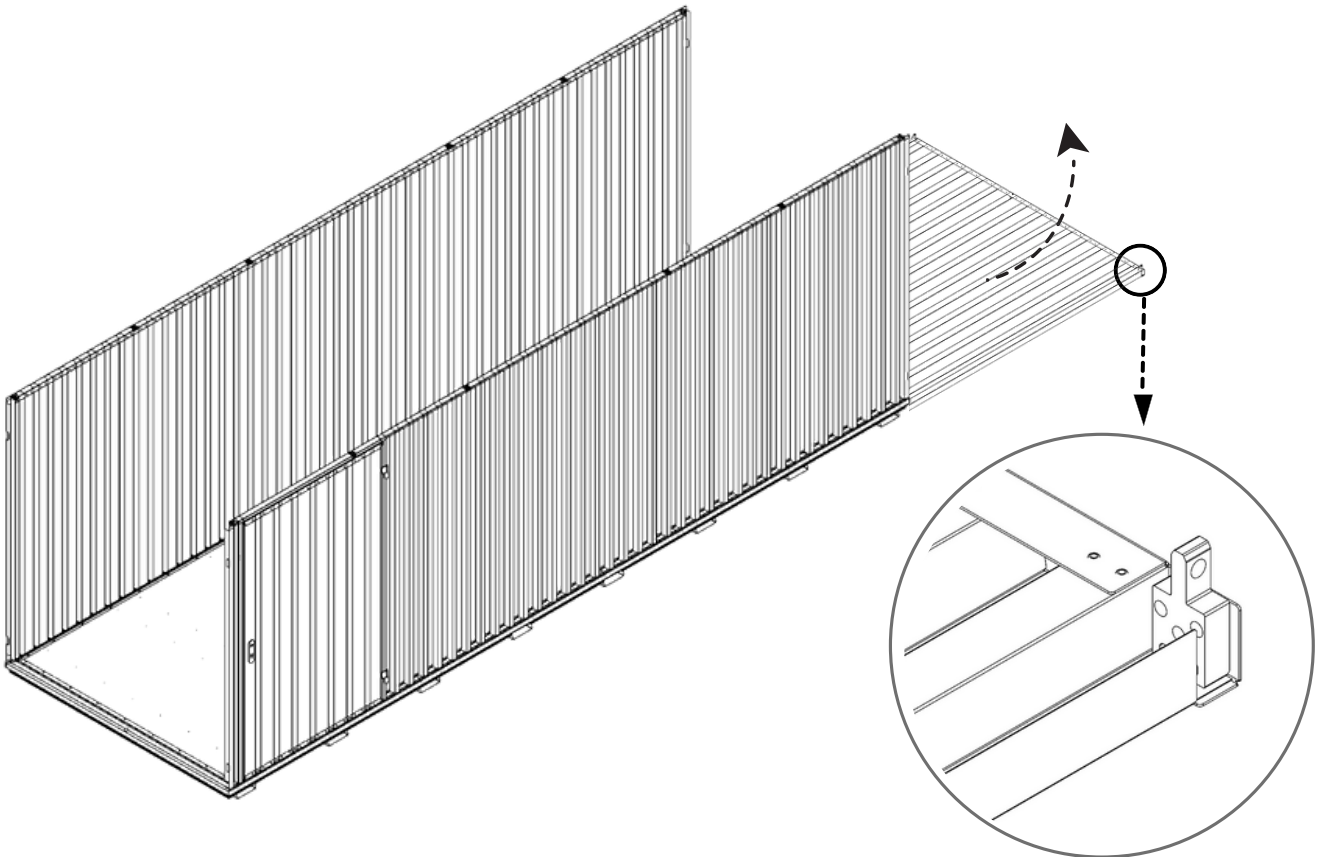

3.1

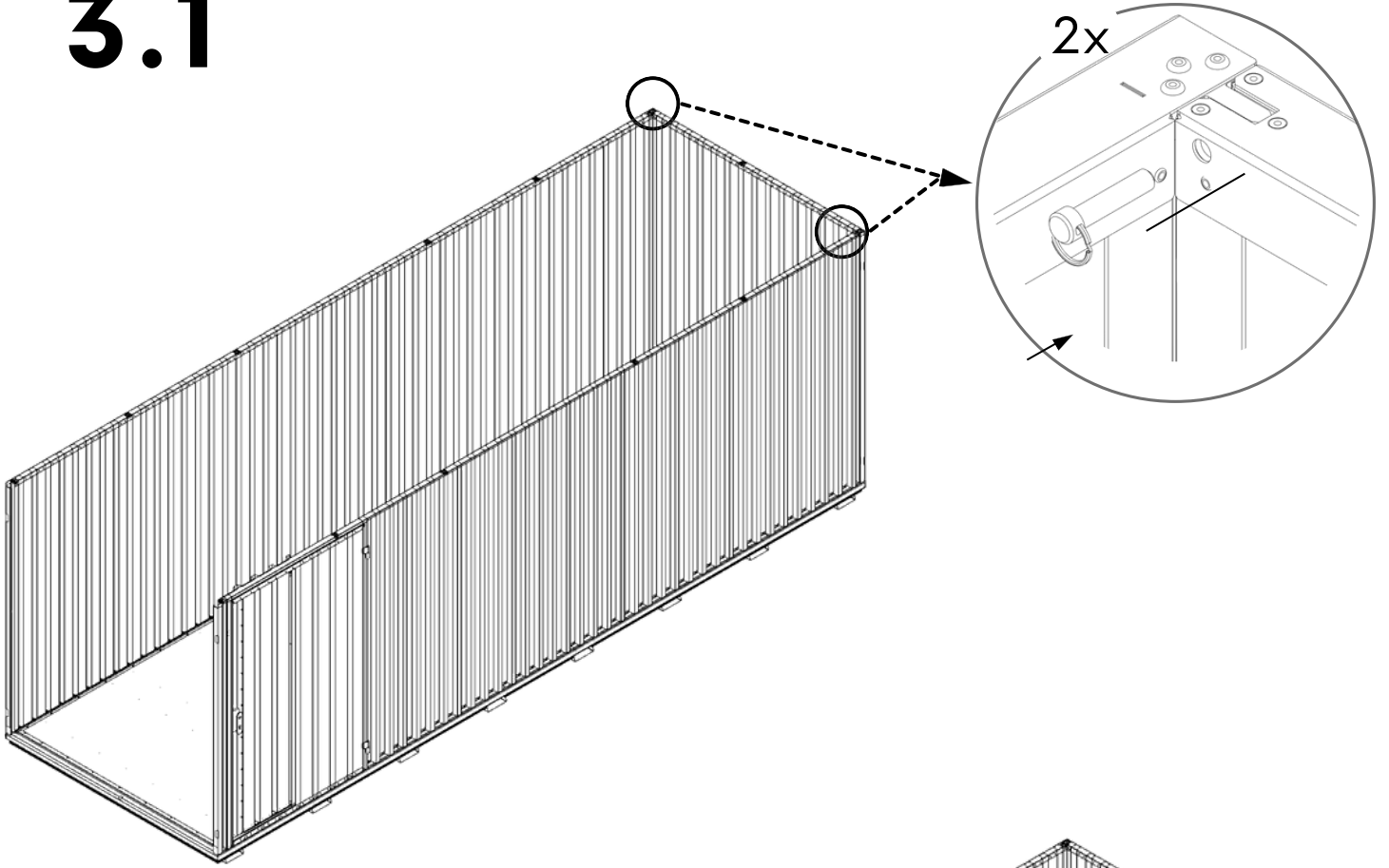



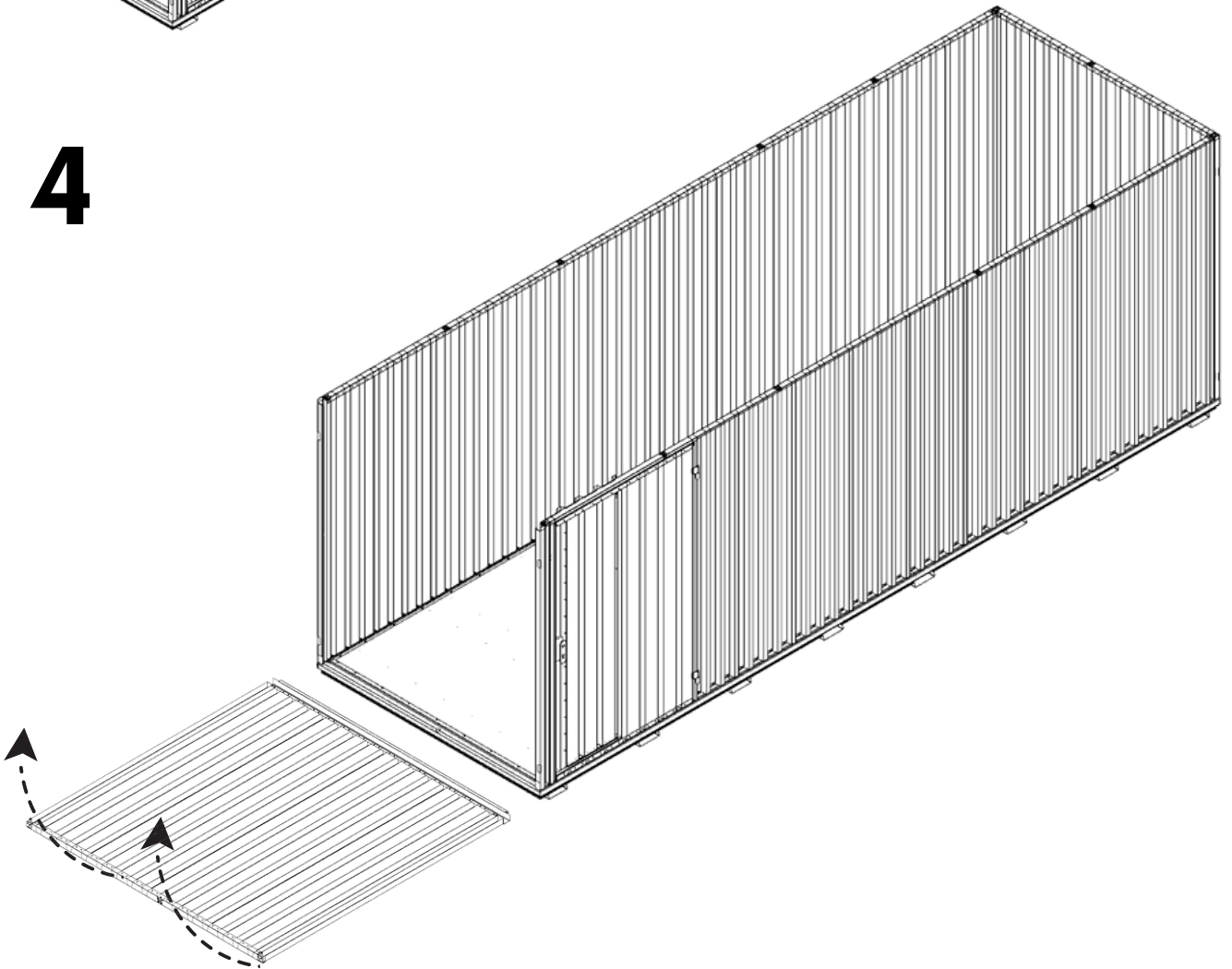



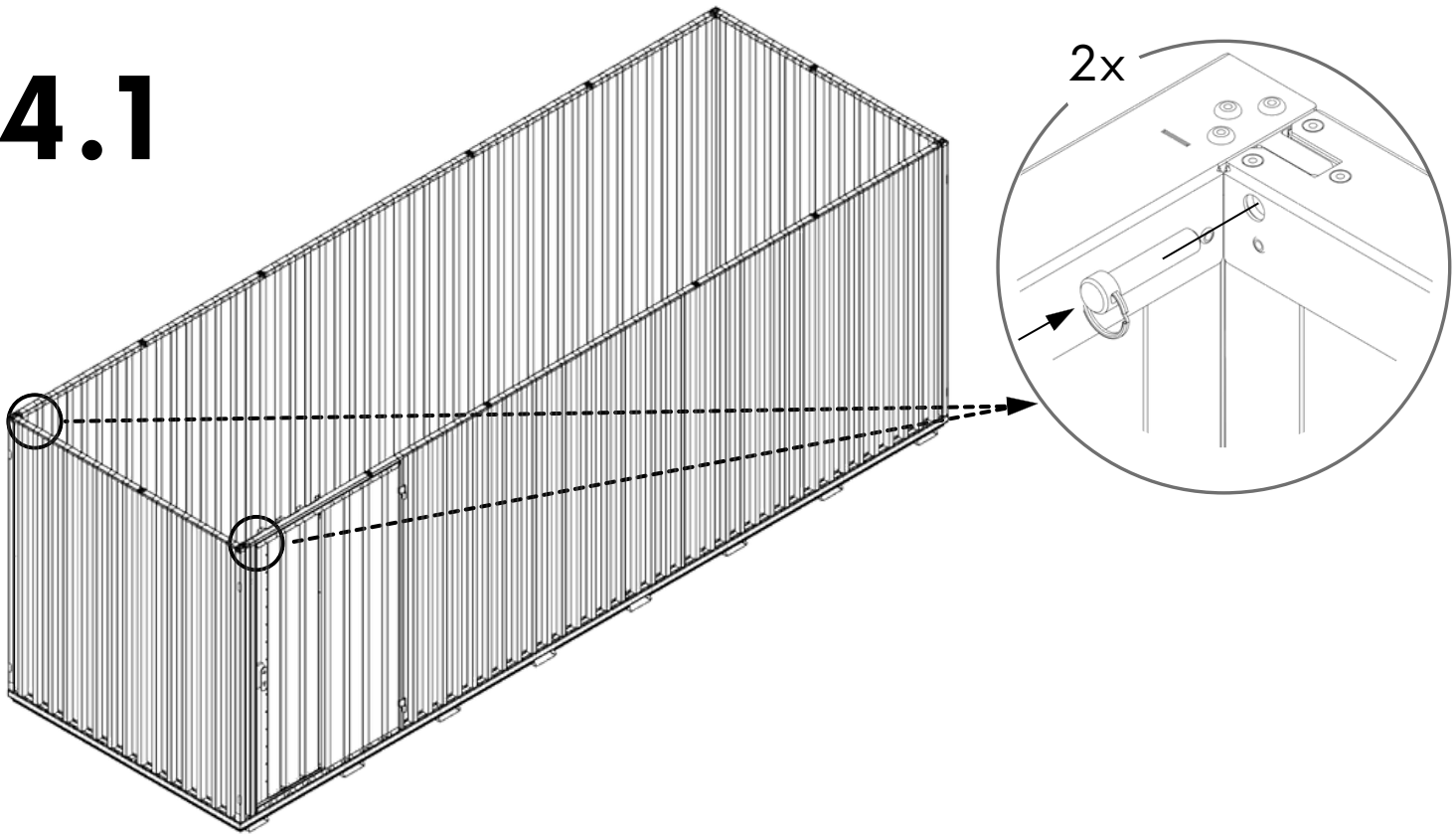

4



4.1



 579 KG	 1640 MM	Model Code: 60.110.450 Production Tracking Code:/X09.1.60.450  9001  14001  50001	 	
---	--	---	---	---

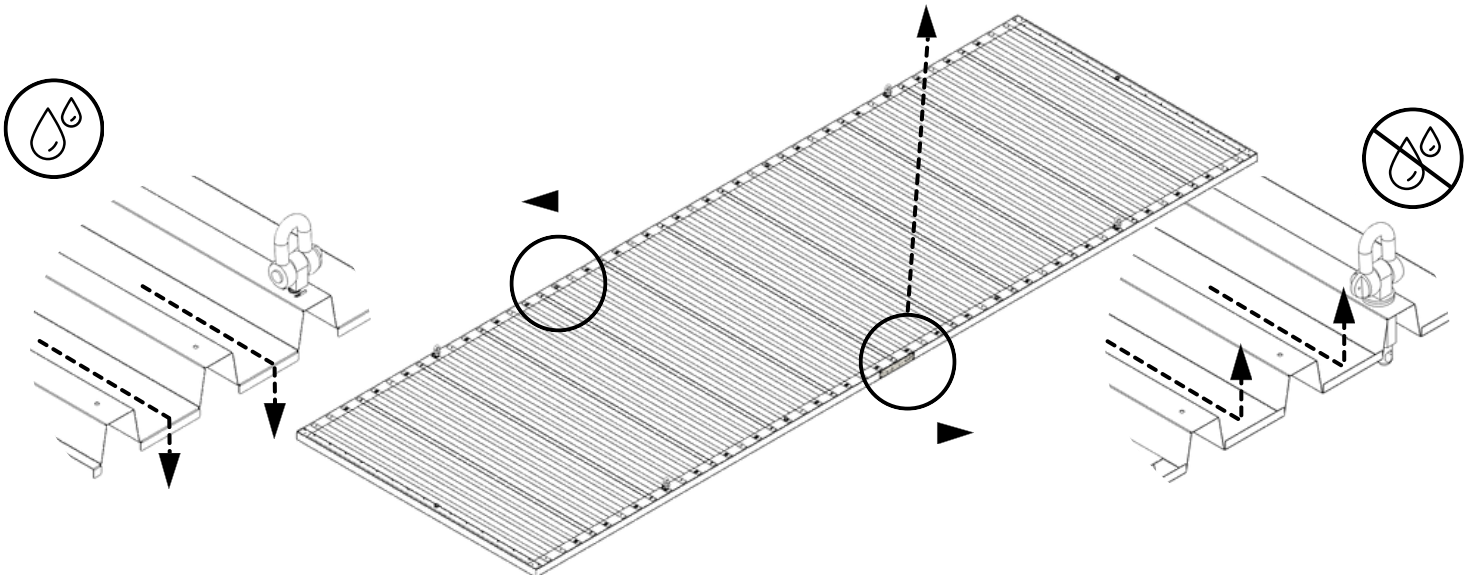

5

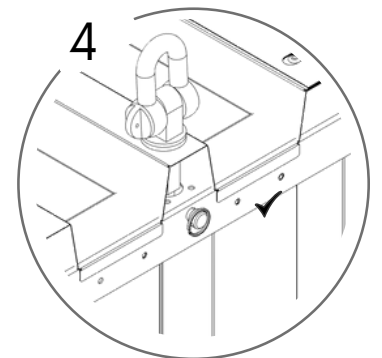
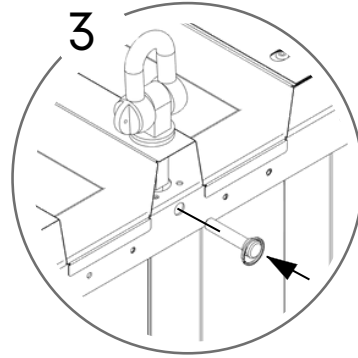
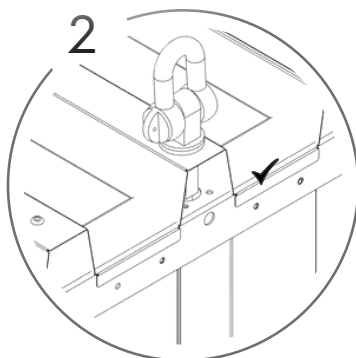
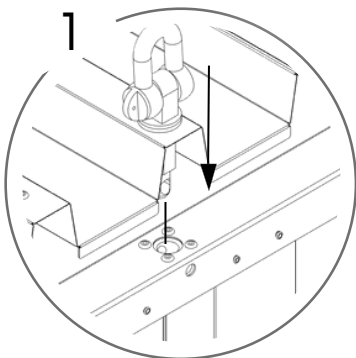
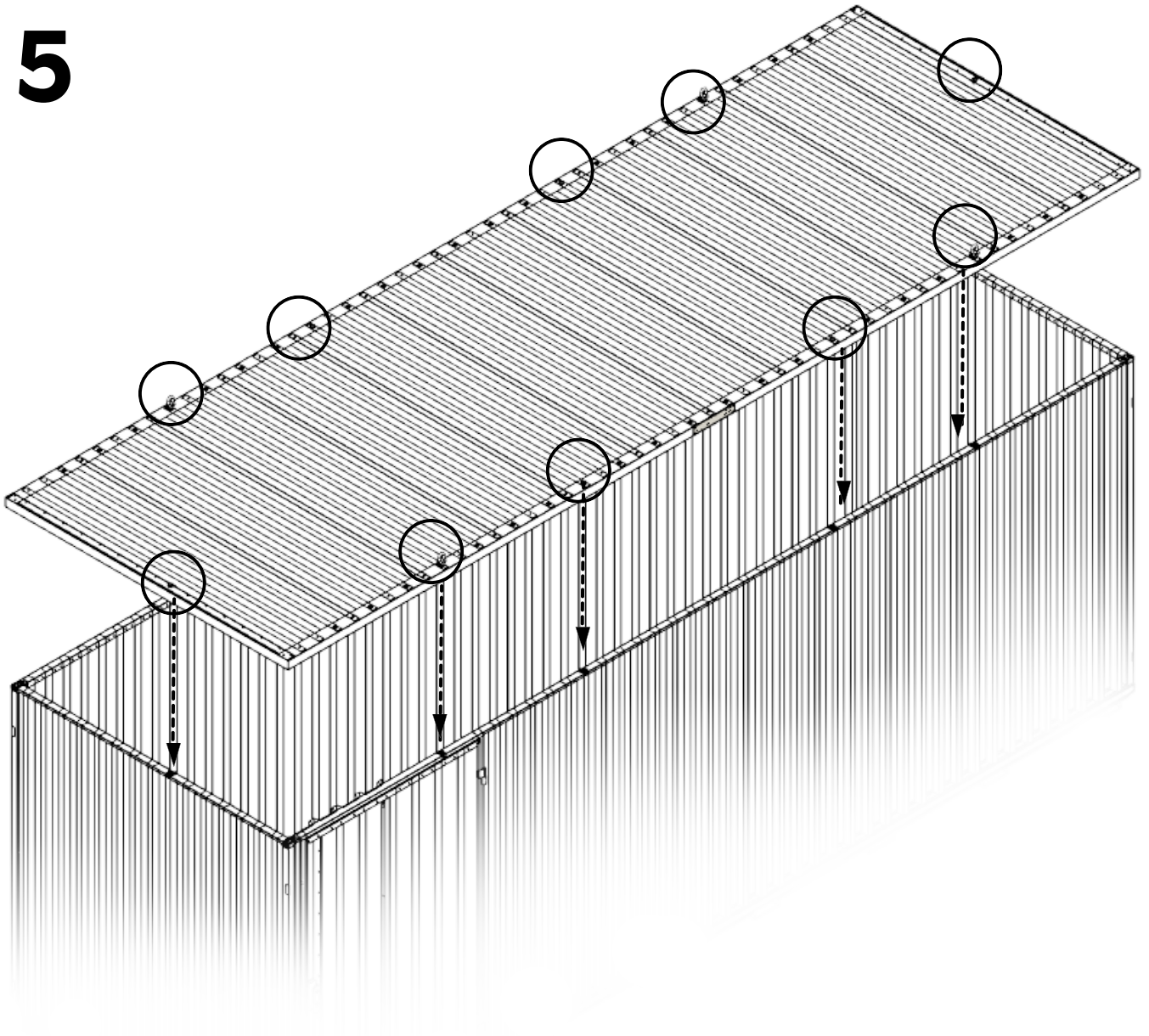

6

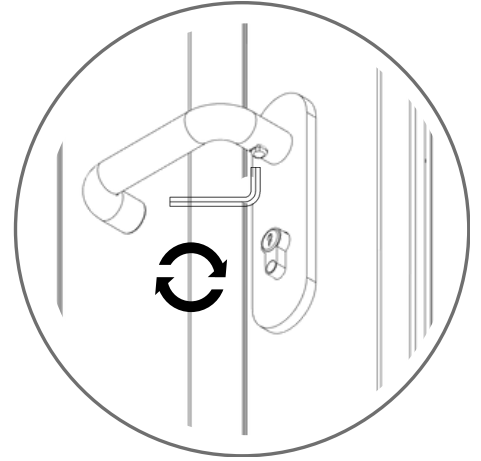
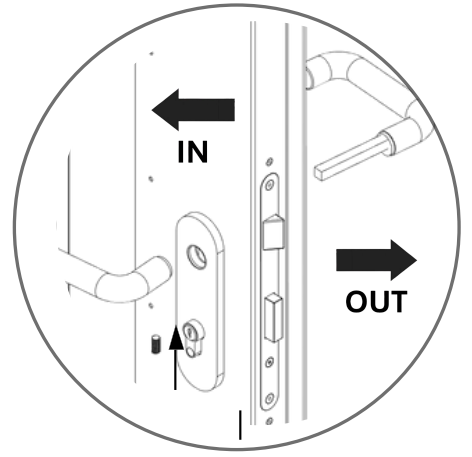
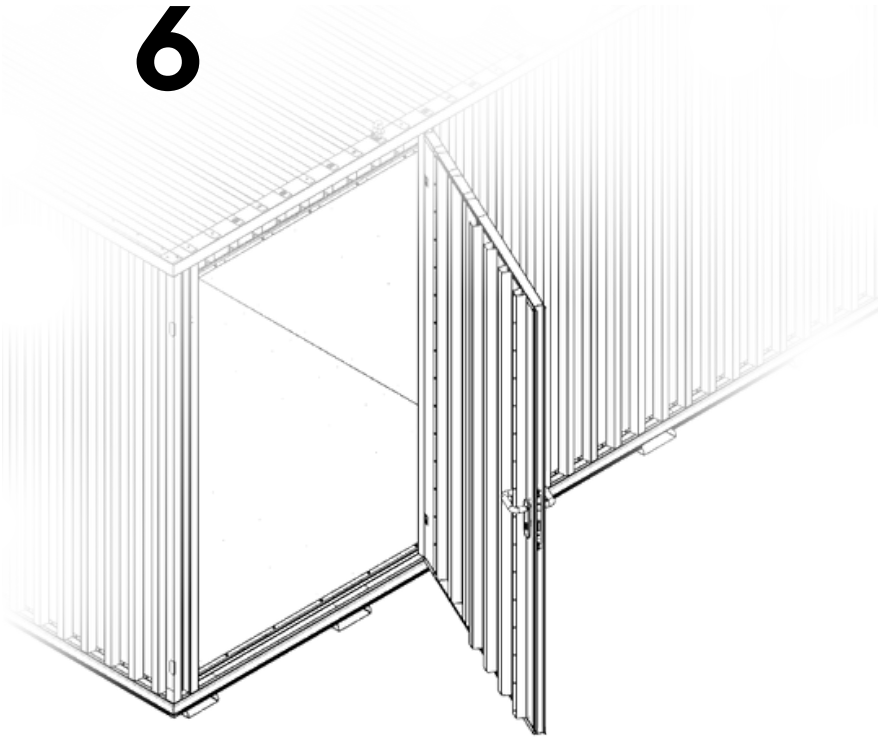

7

