

PRODUCT CODE:50.110.430.330

prefabase
Quick Build Solutions

Instructions and User Guide

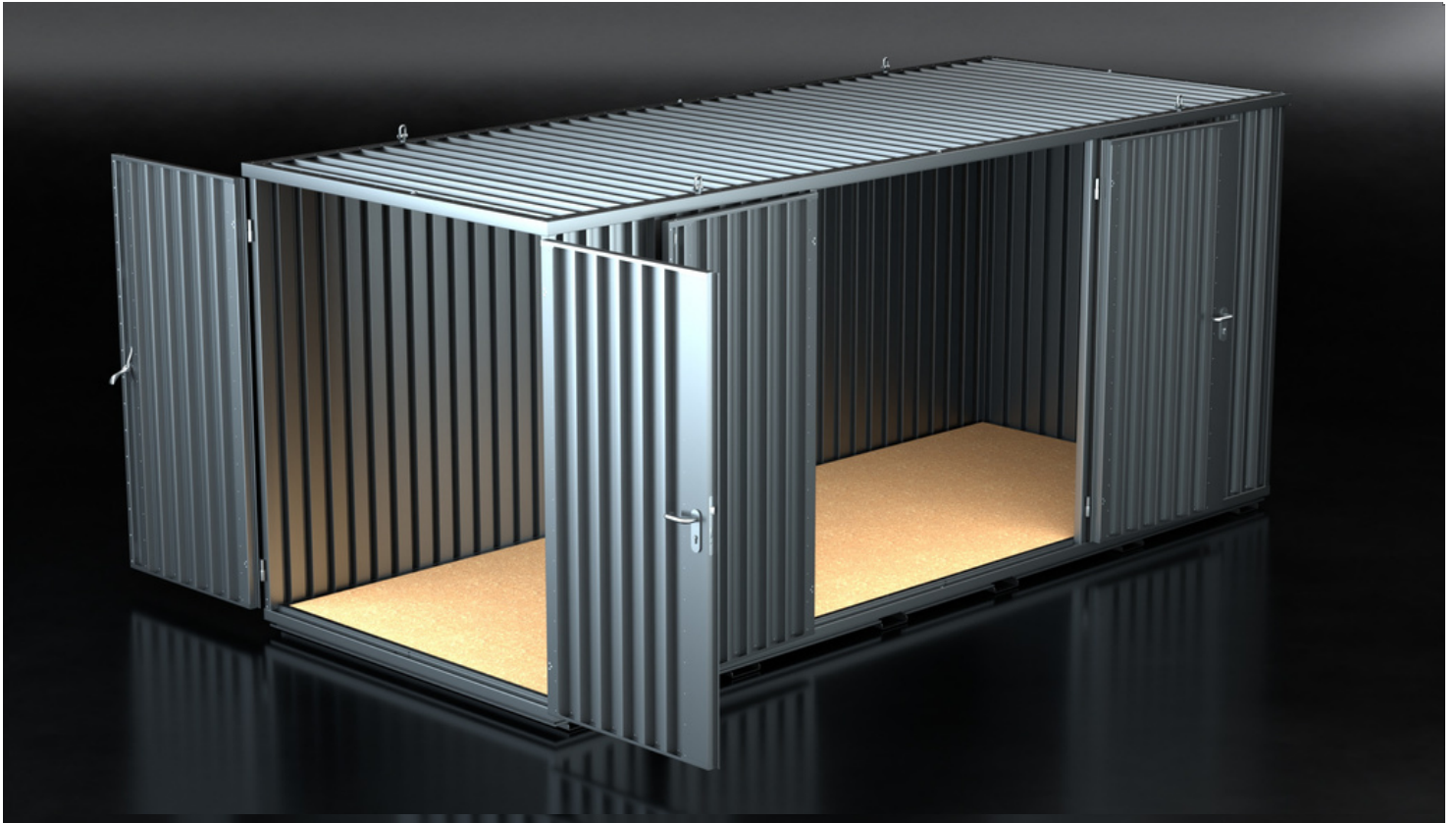

50.0110

1x

50.0430/0230/0220

1x

50.0410

1x

0220/0230

1x

0310

1x

50.0510

1x

0099.61.101

2x

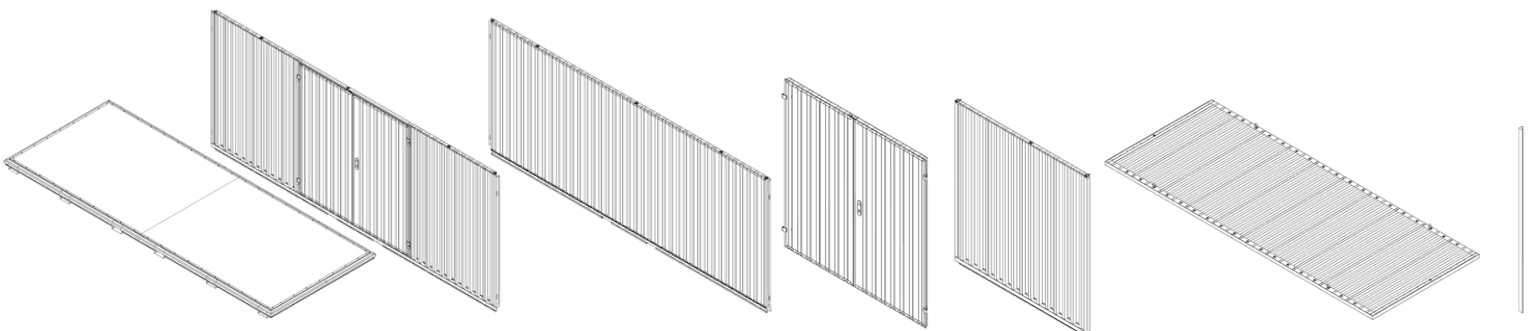



12x



2x



1x



2x

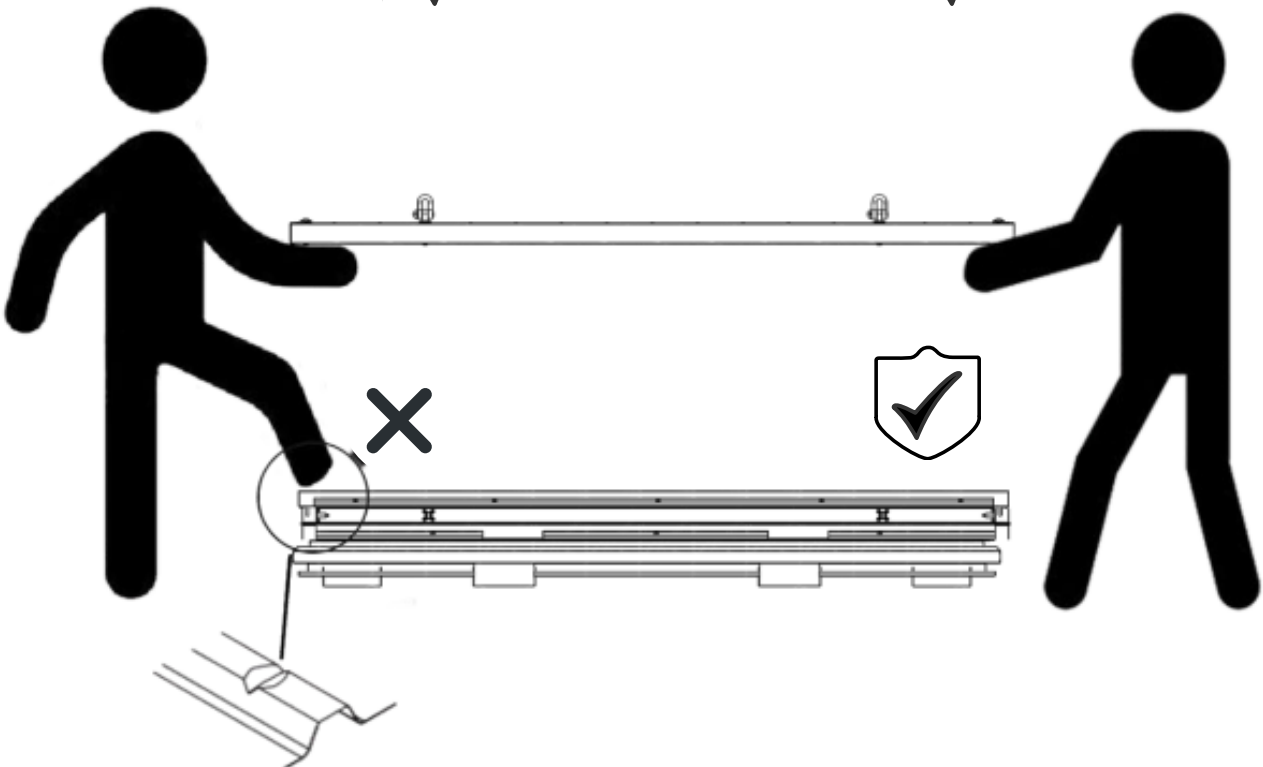

1

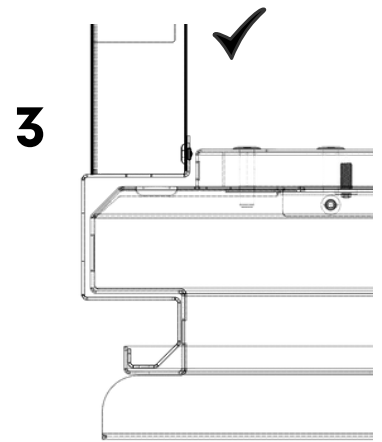
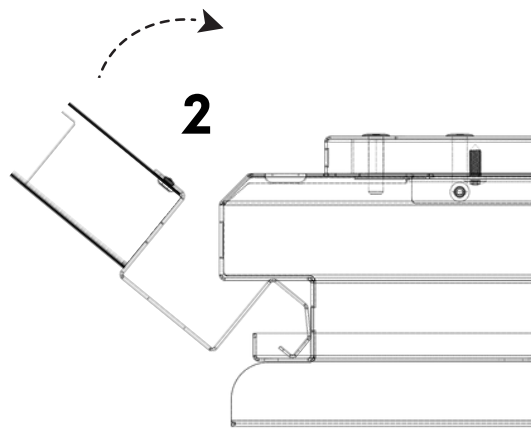
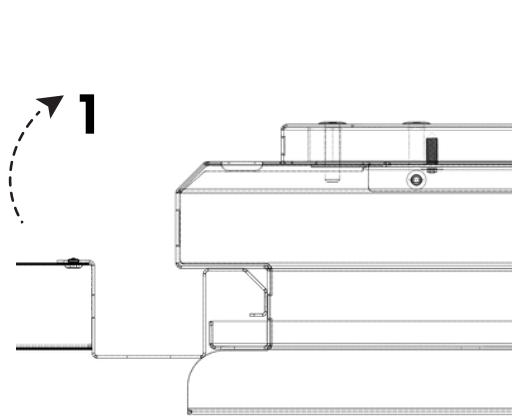
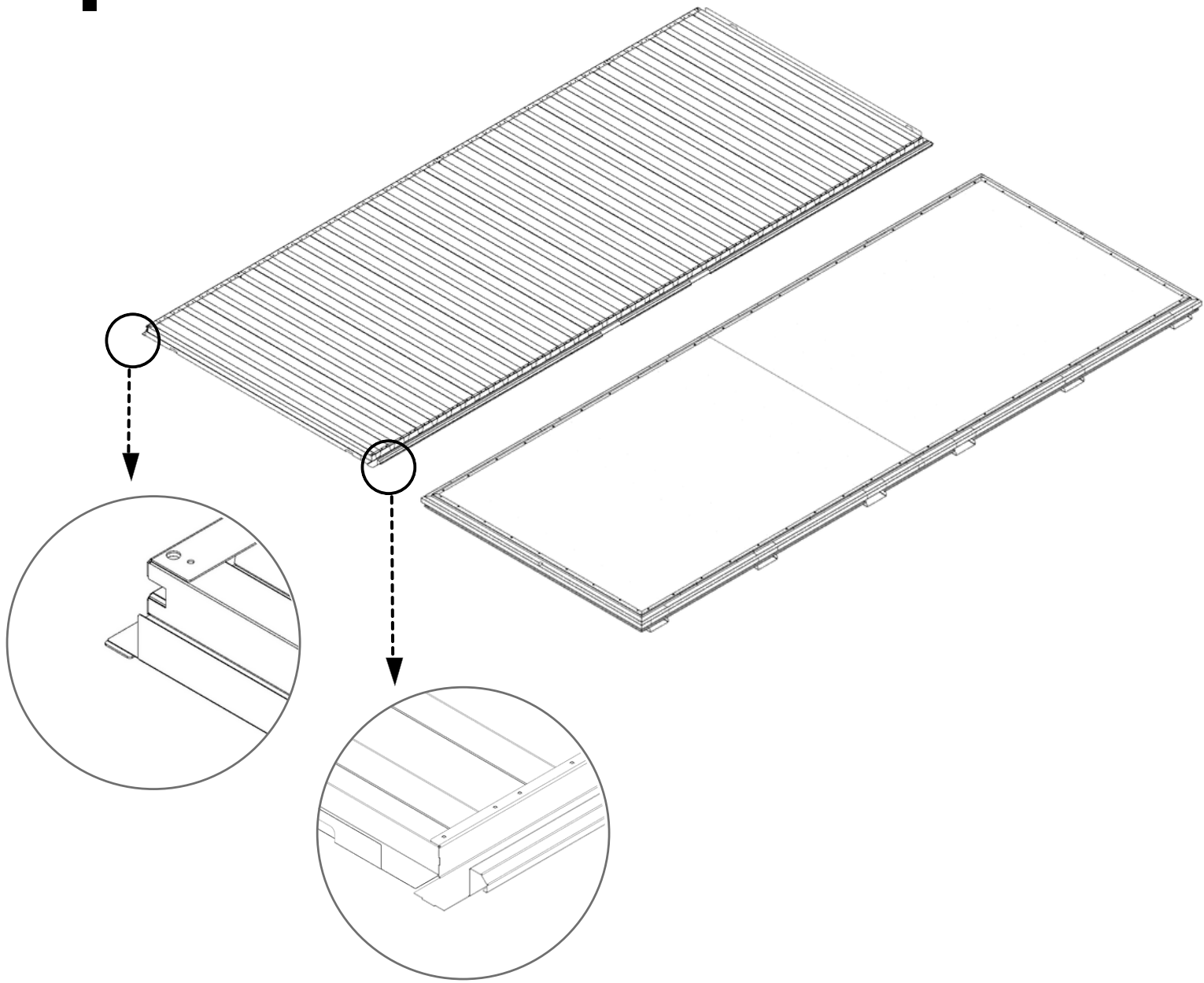

2

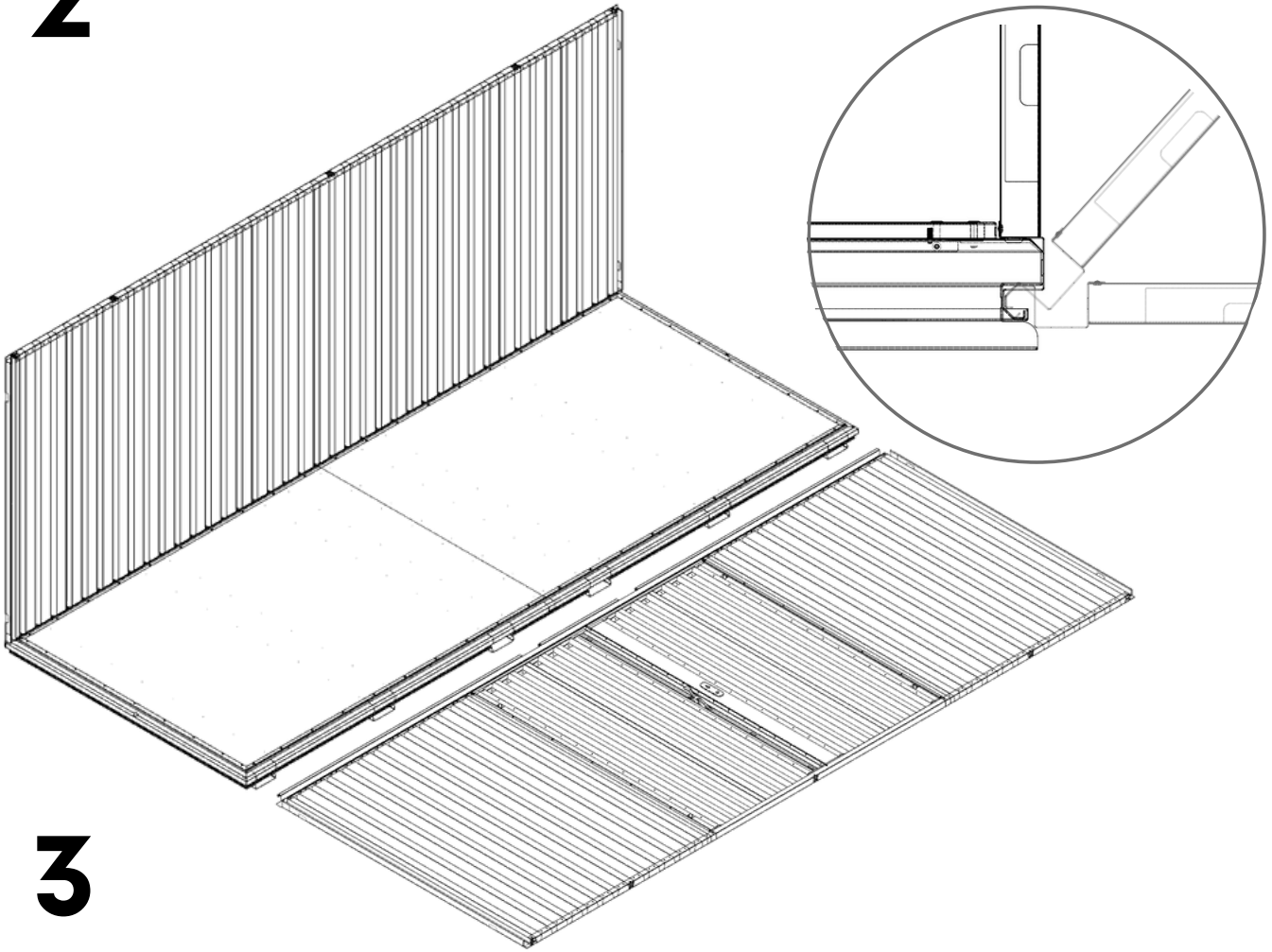

3

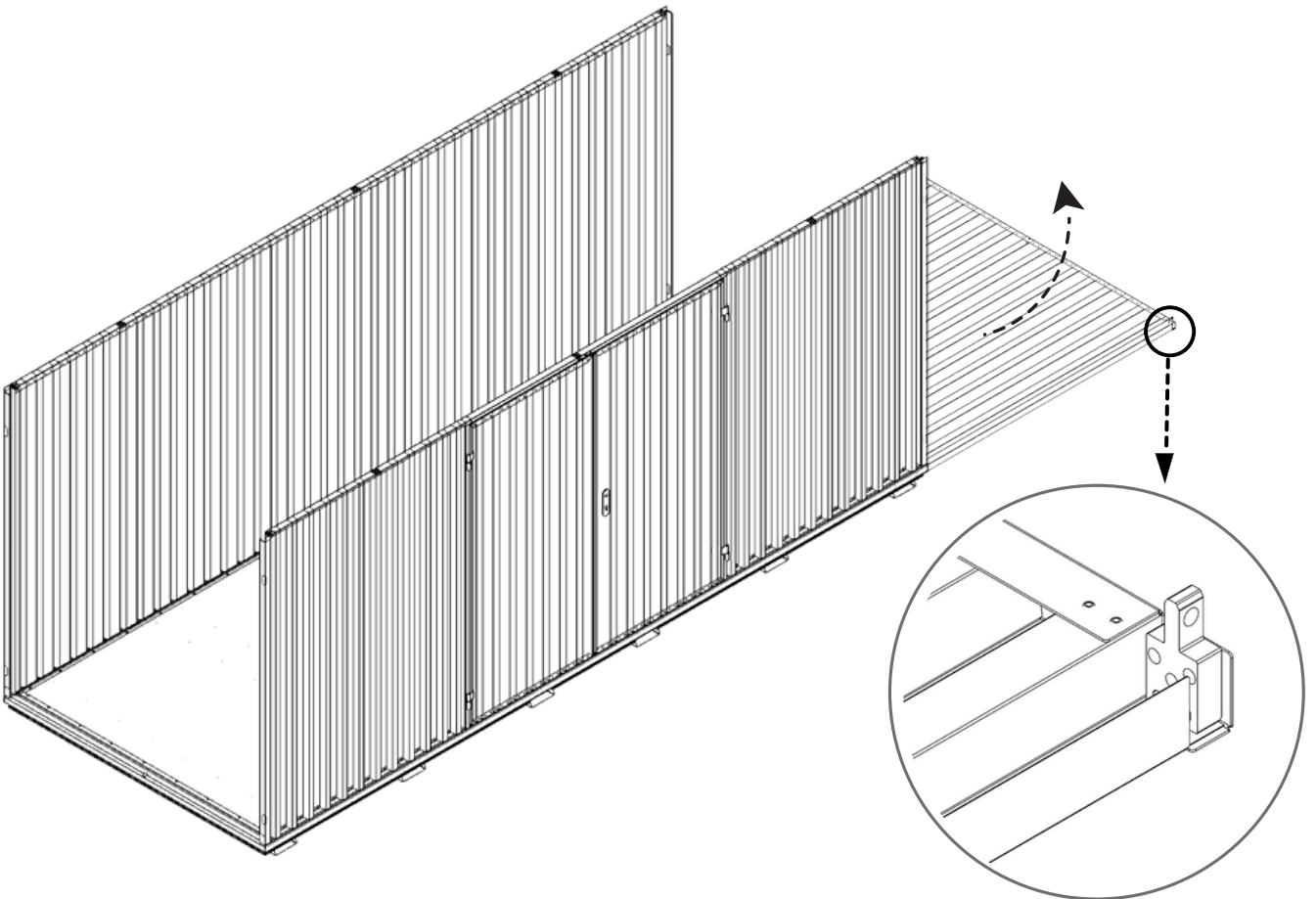

3.1

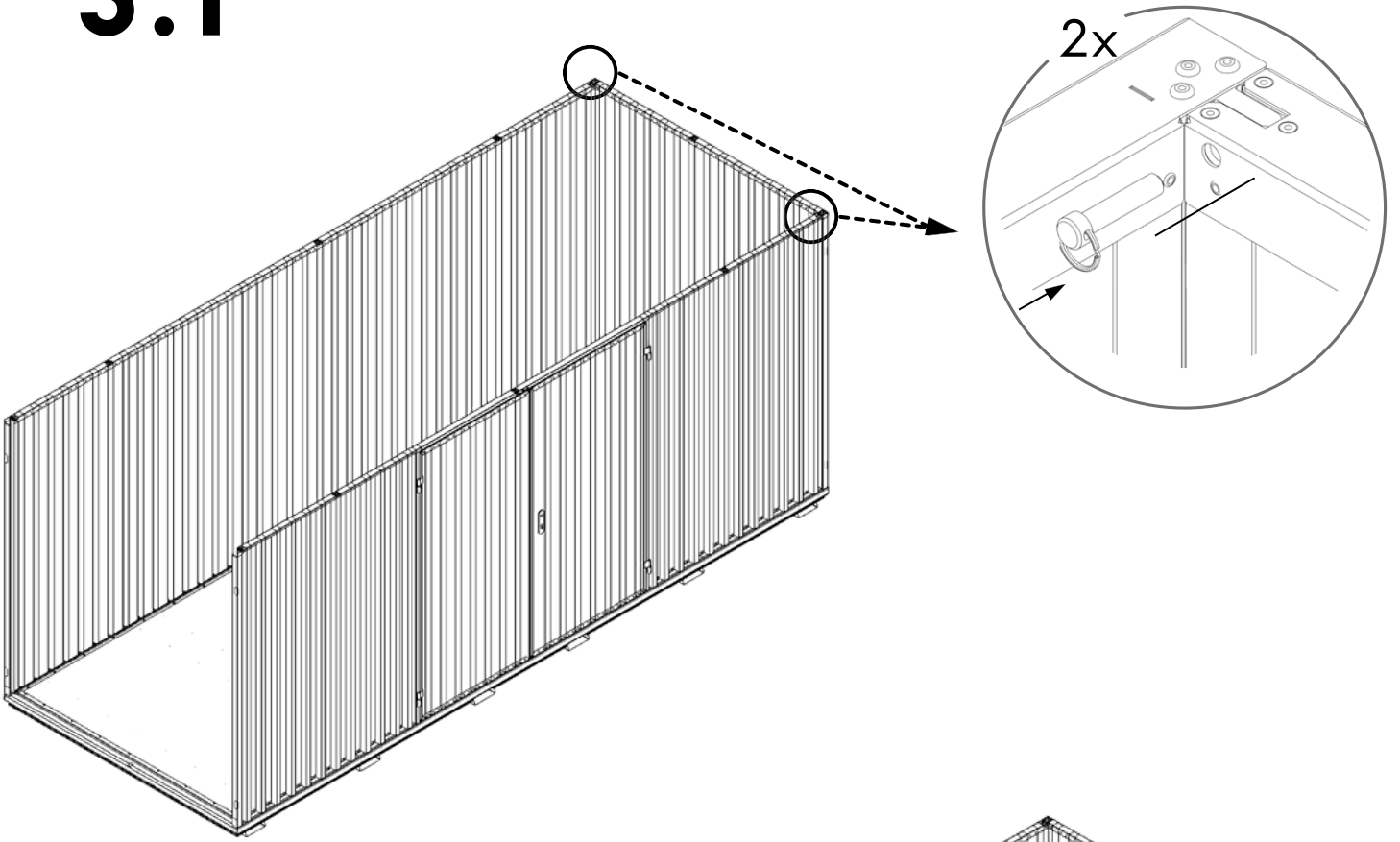



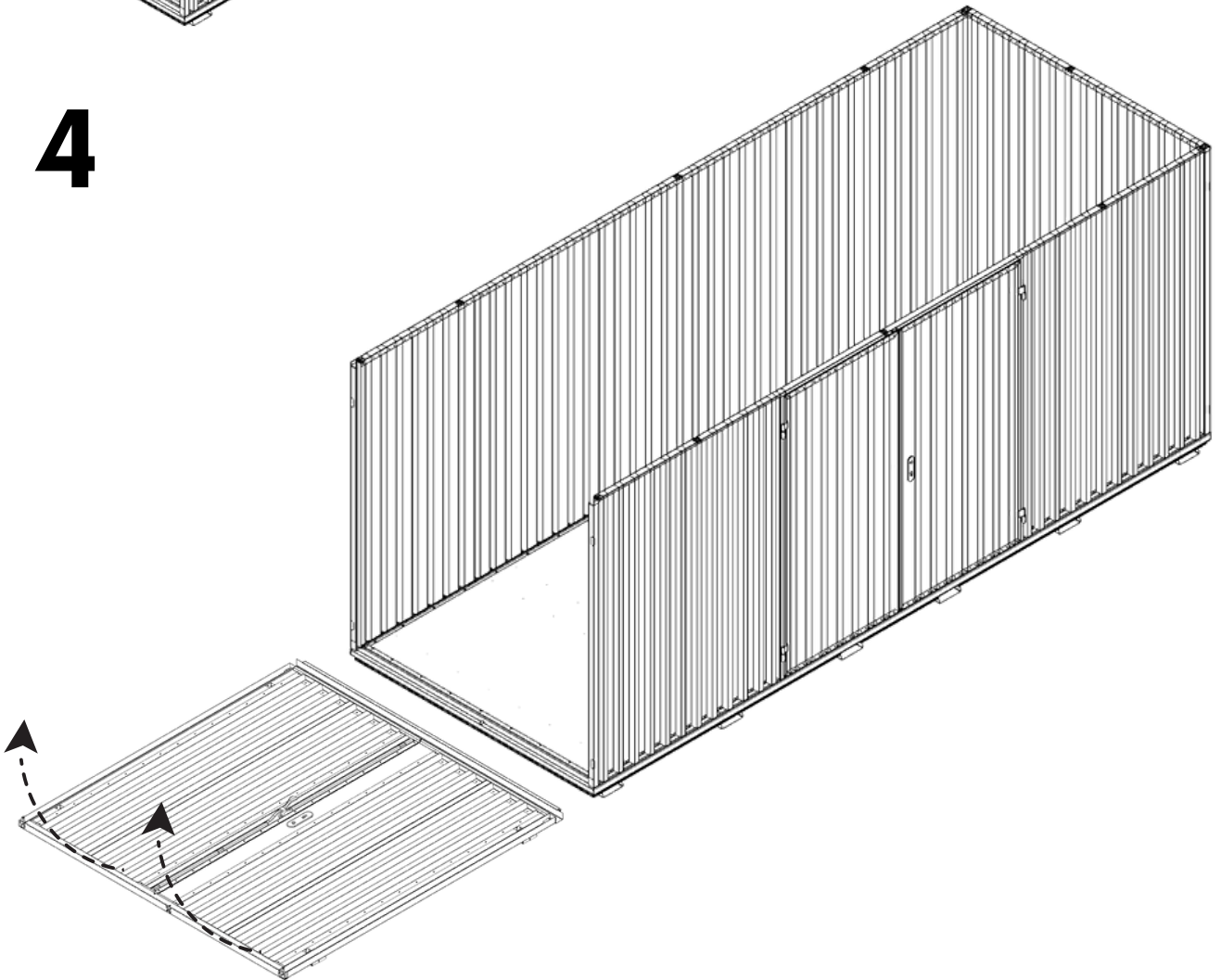



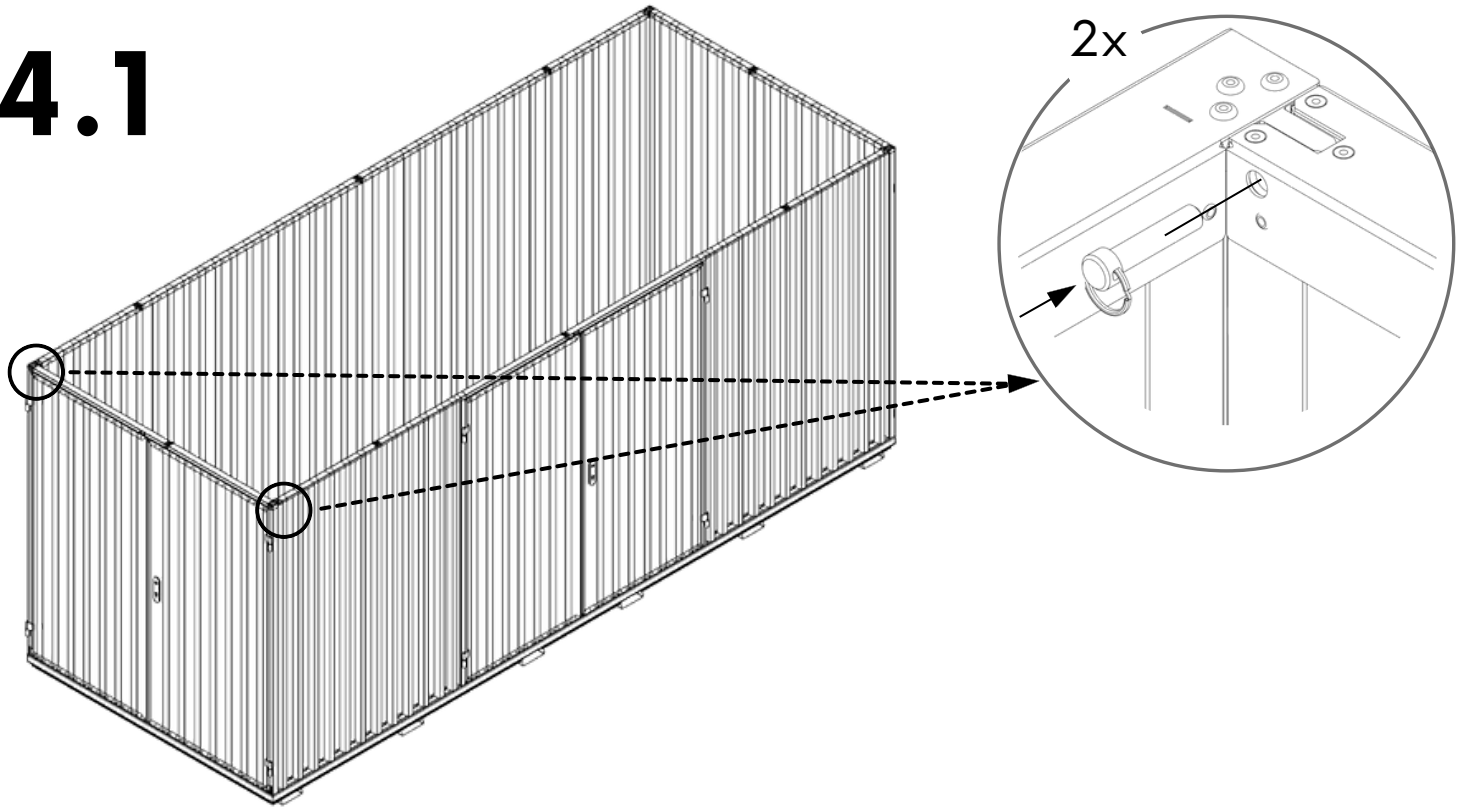

4



4.1



 336 KG	 3 TON	 1640 MM	Model Code: 30.110.440 Production Tracking Code:X09.1.30.440  9001  14001  50001	  
---	--	--	---	---

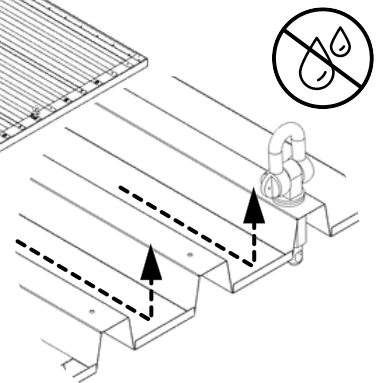
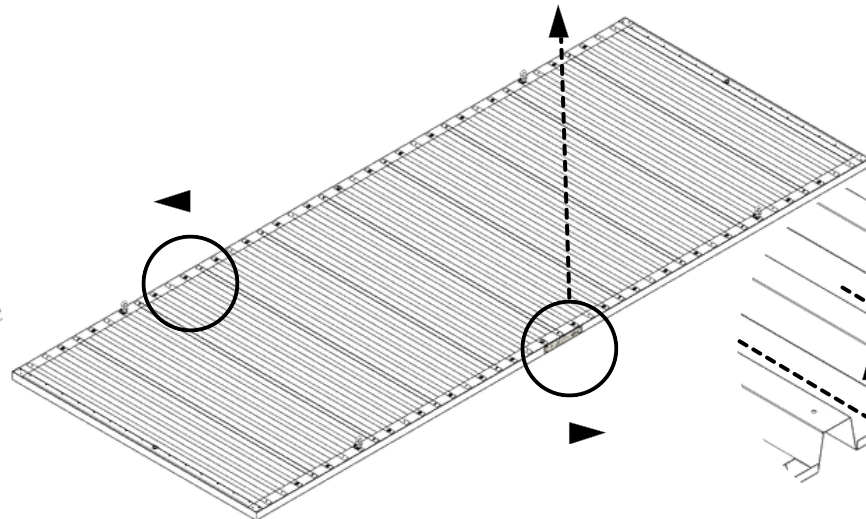
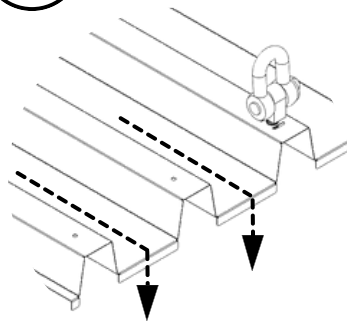

5

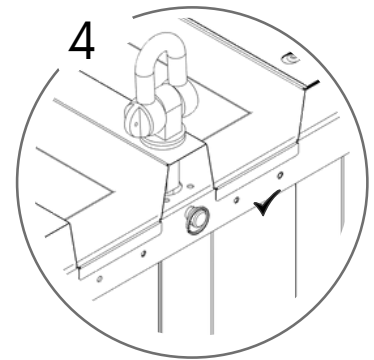
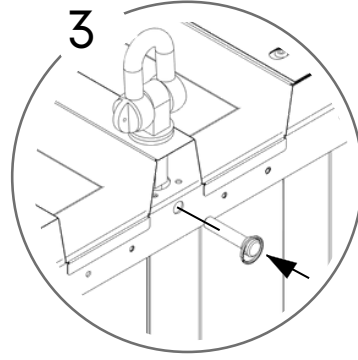
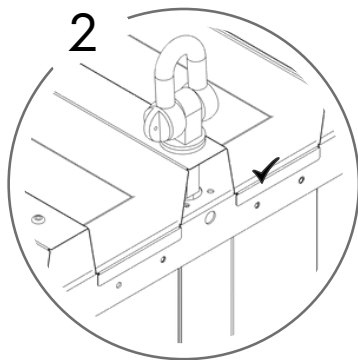
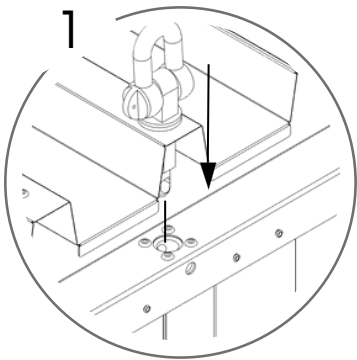
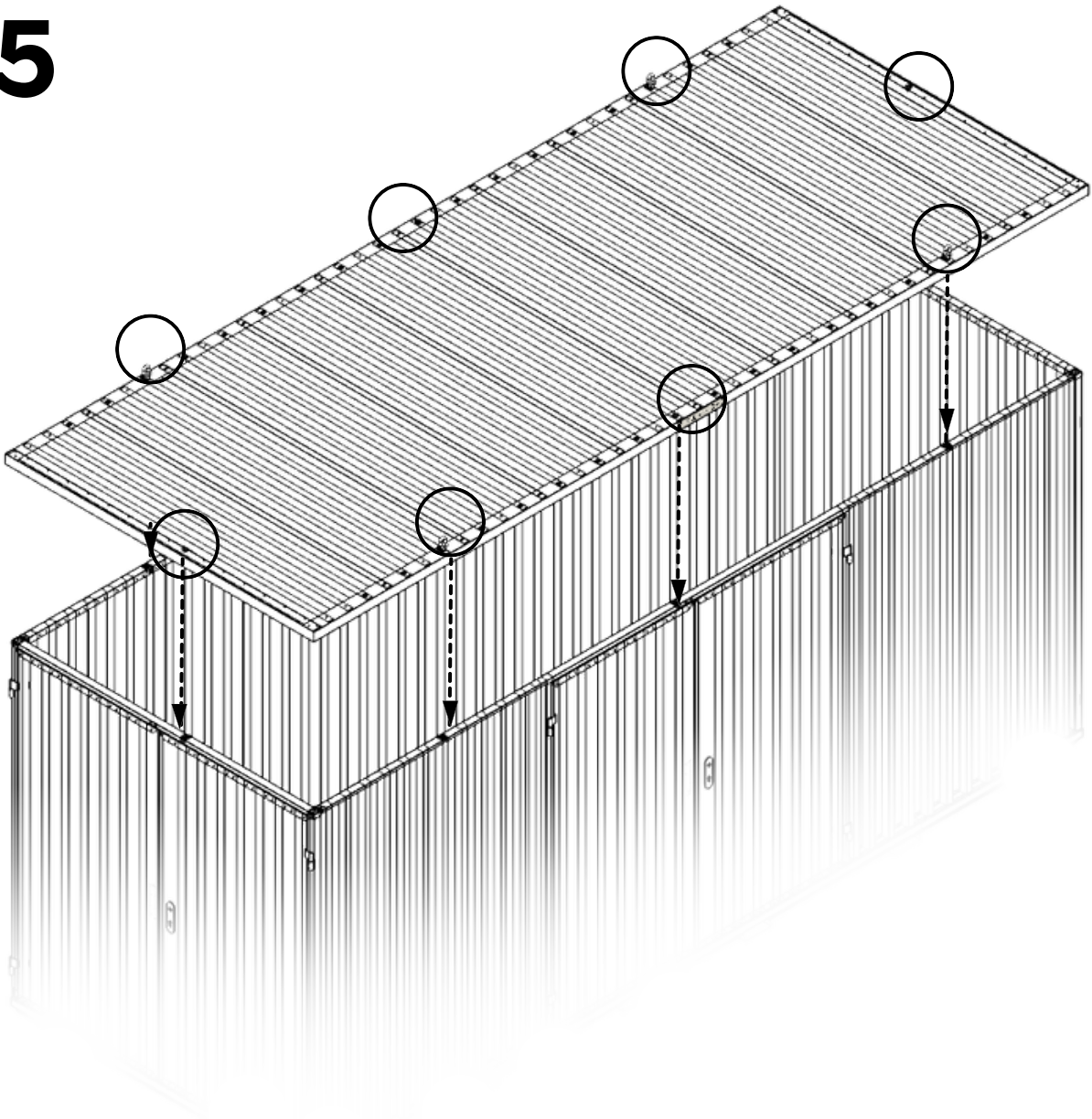

6

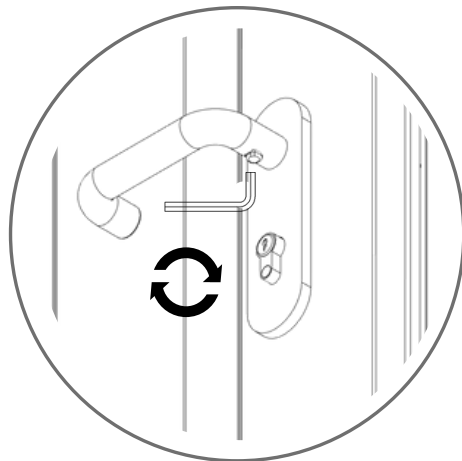
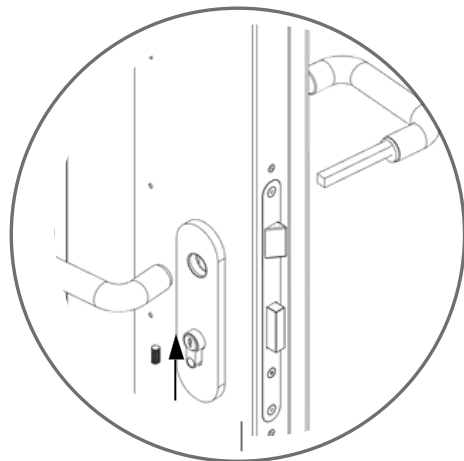
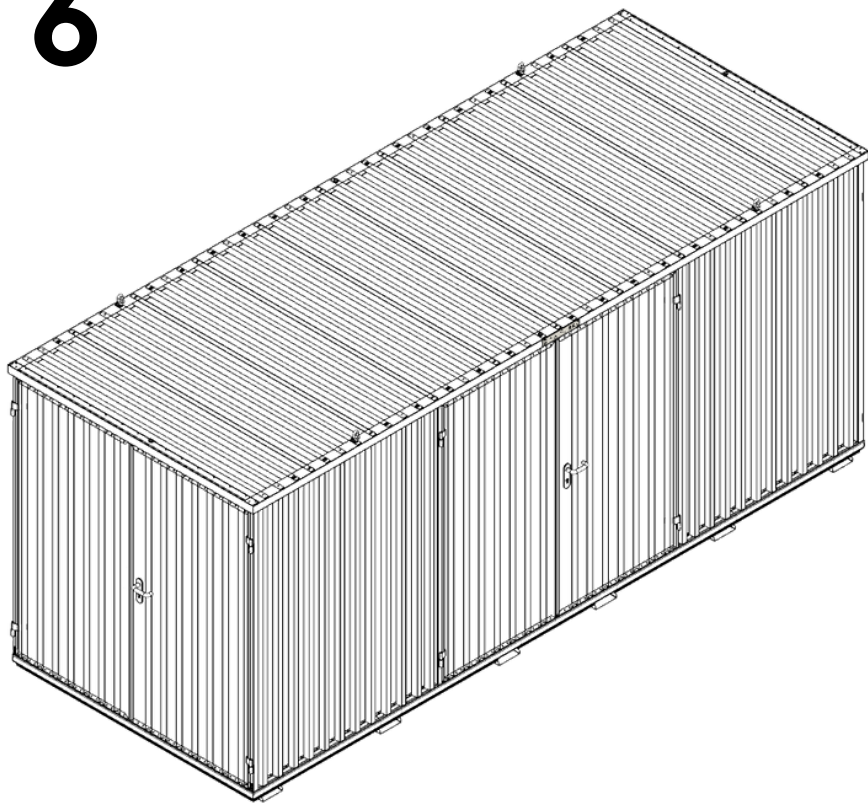

7

