

PRODUCT CODE:40.110.450.330

**prefabase**  
Quick Build Solutions

Instructions and User Guide



40.0110  
1x

40.0410  
1x

40.0450/0210  
1x

0220/0230  
1x

0310  
1x

40.0510  
1x

0099.61.101  
2x

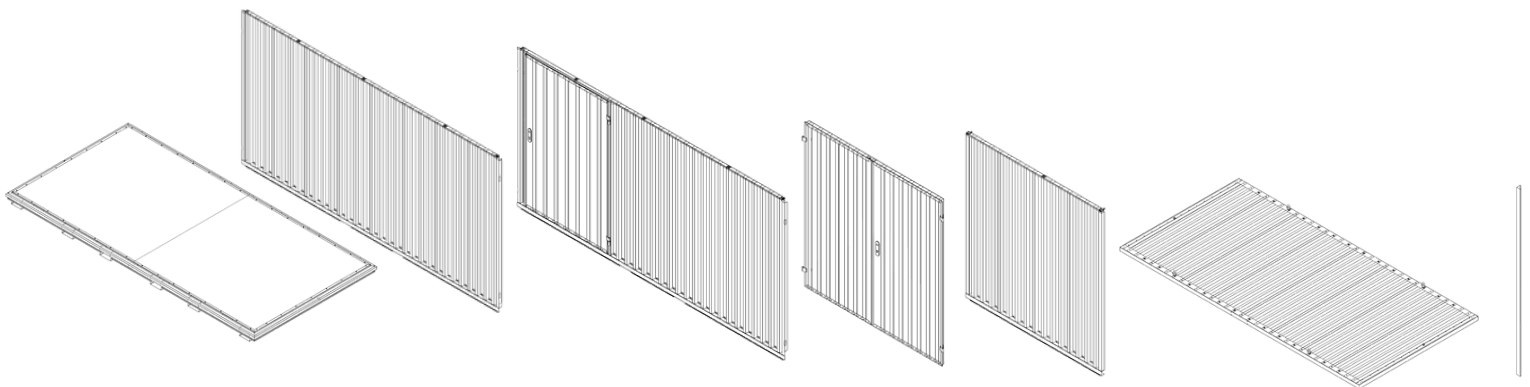



12x

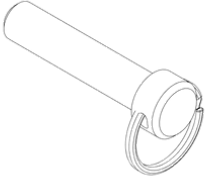

2x

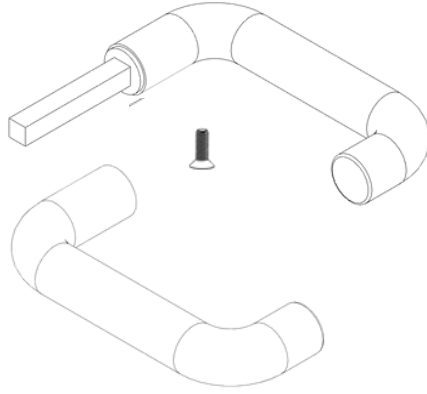

1x

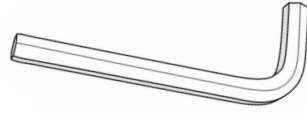

2x

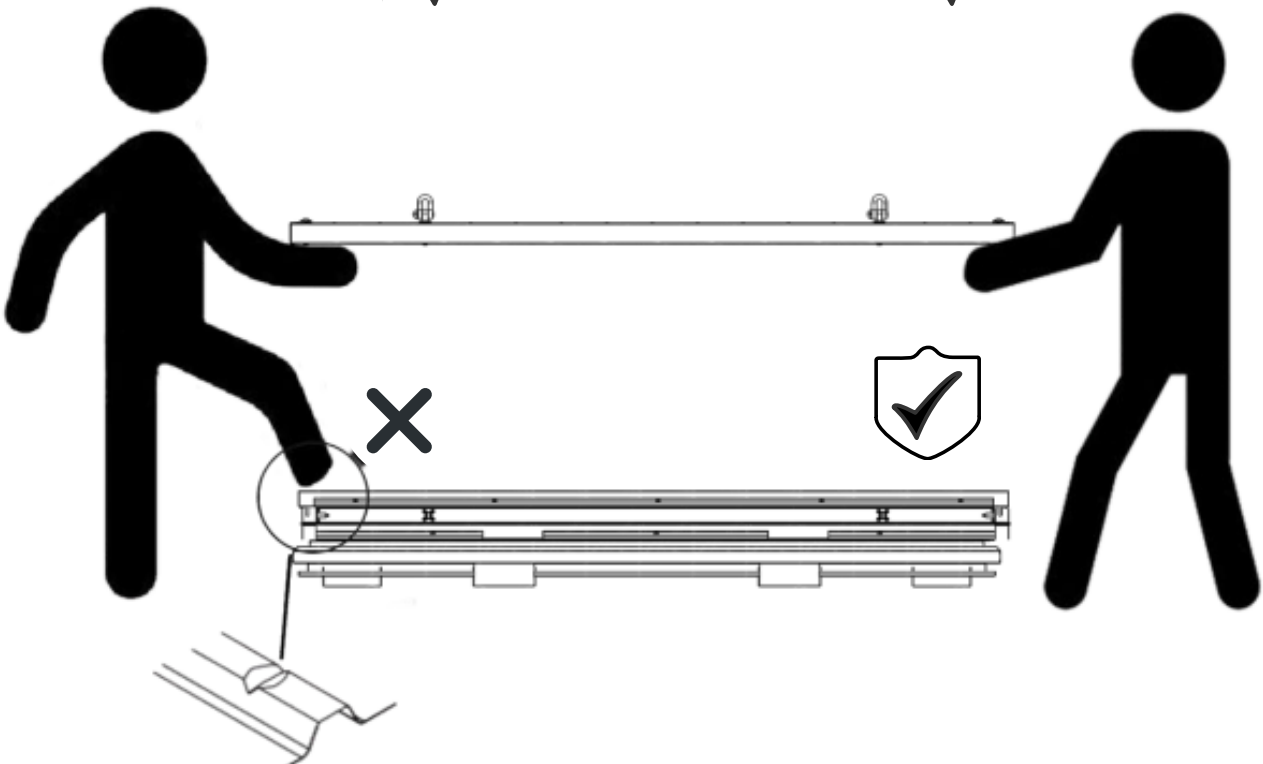
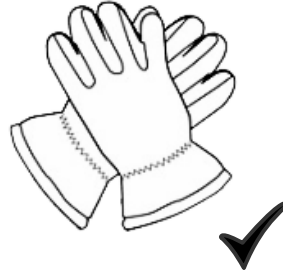

# 1

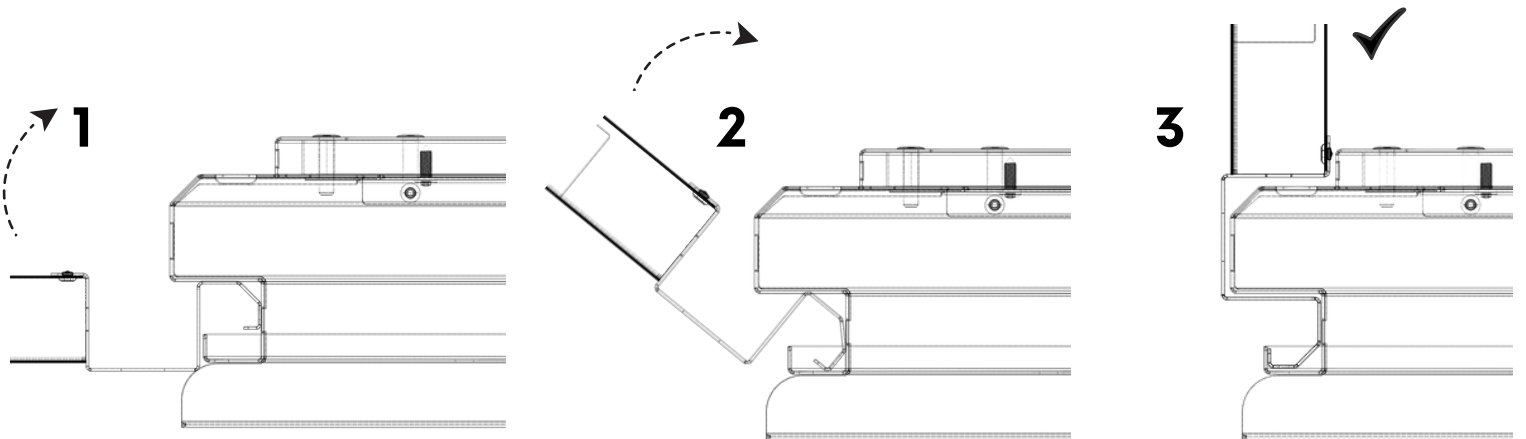
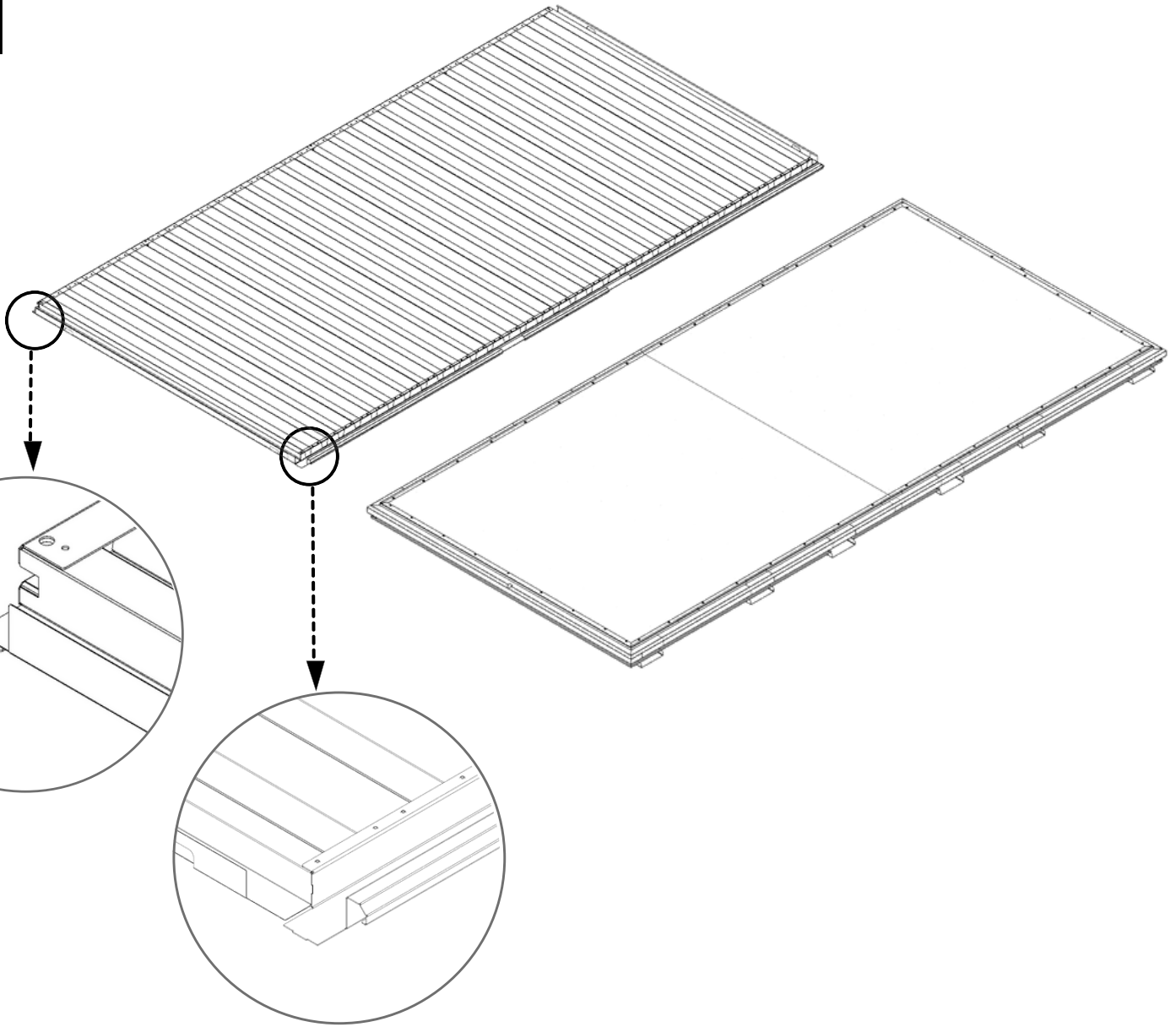

**2**

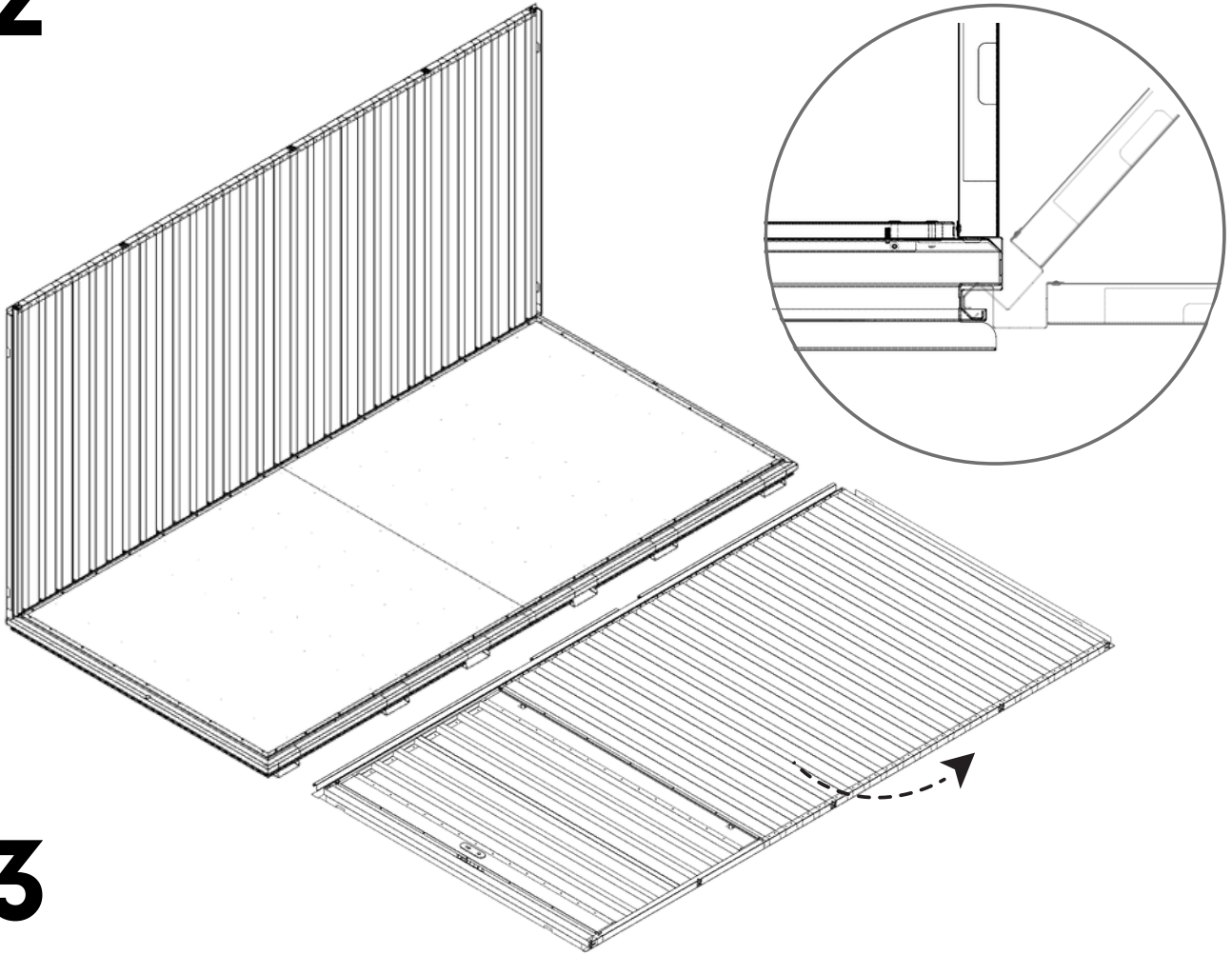

**3**

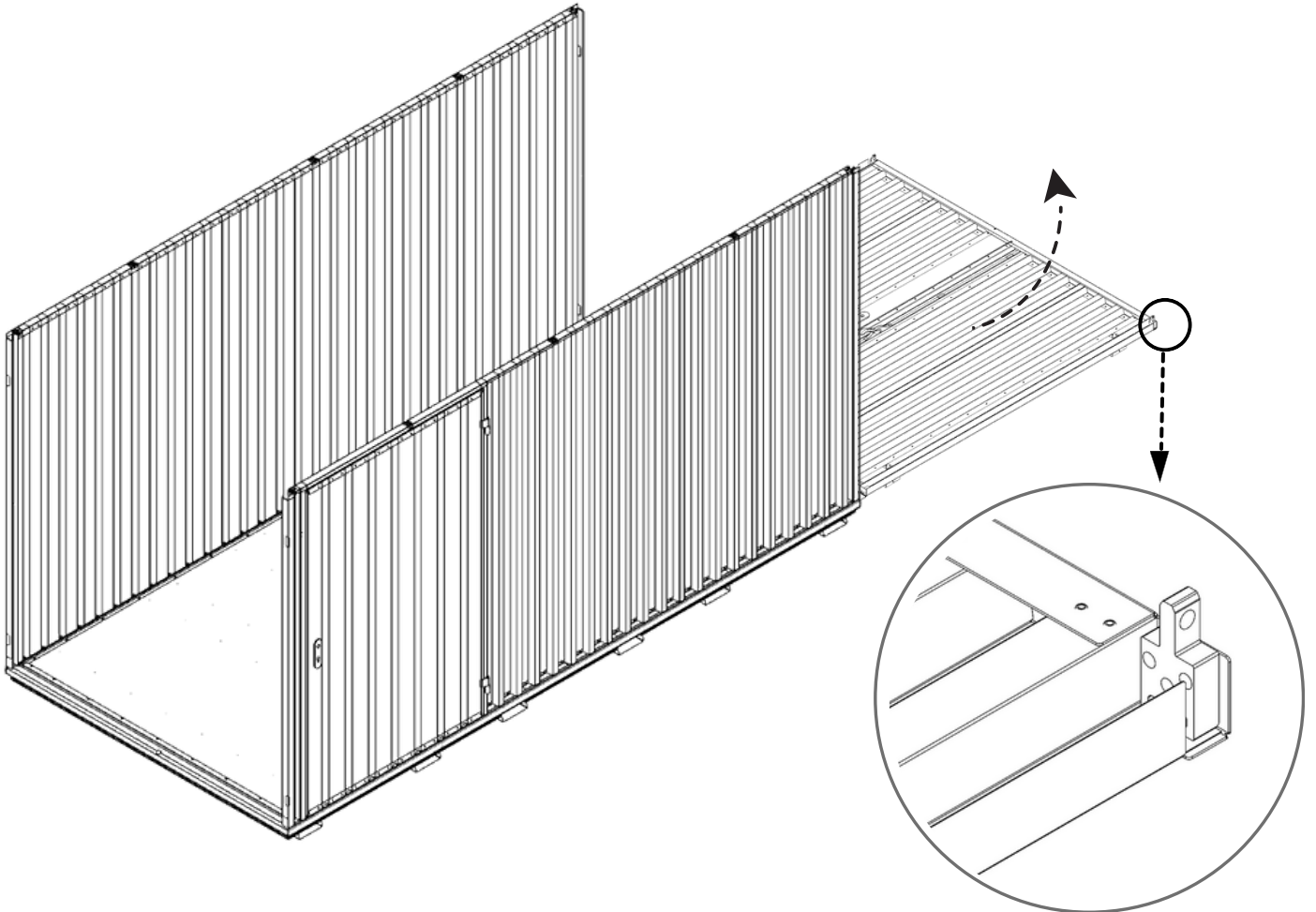

# 3.1

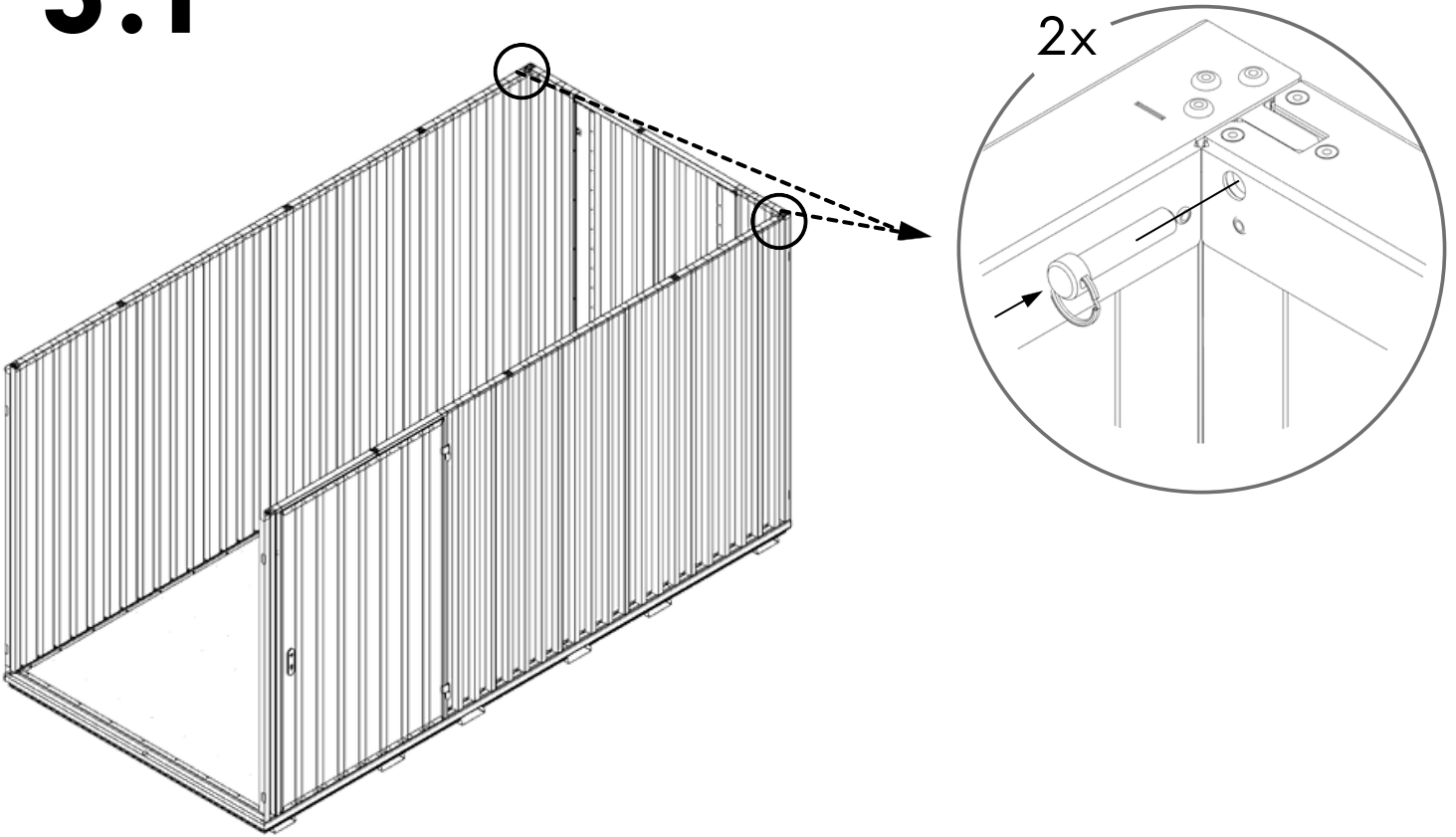



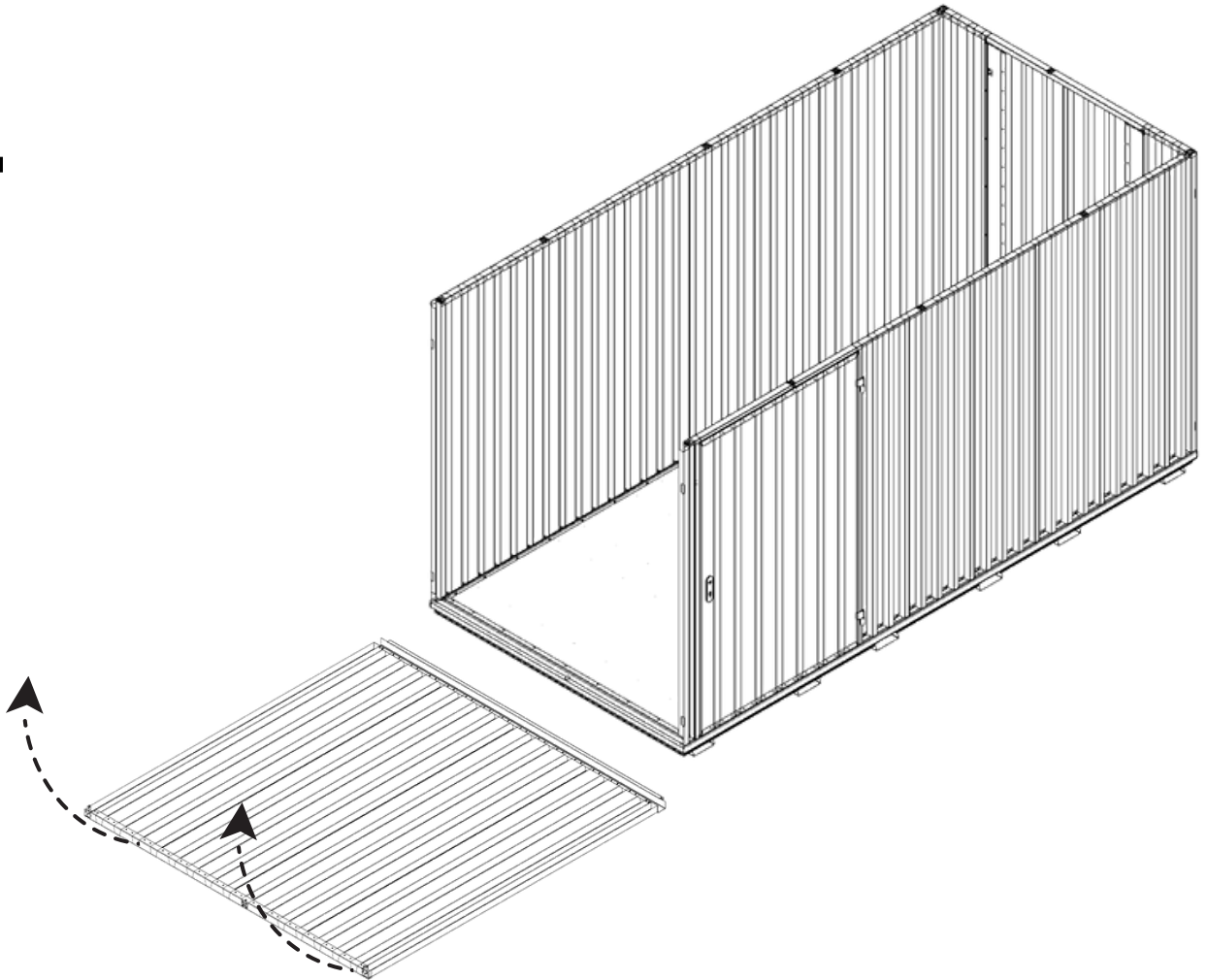



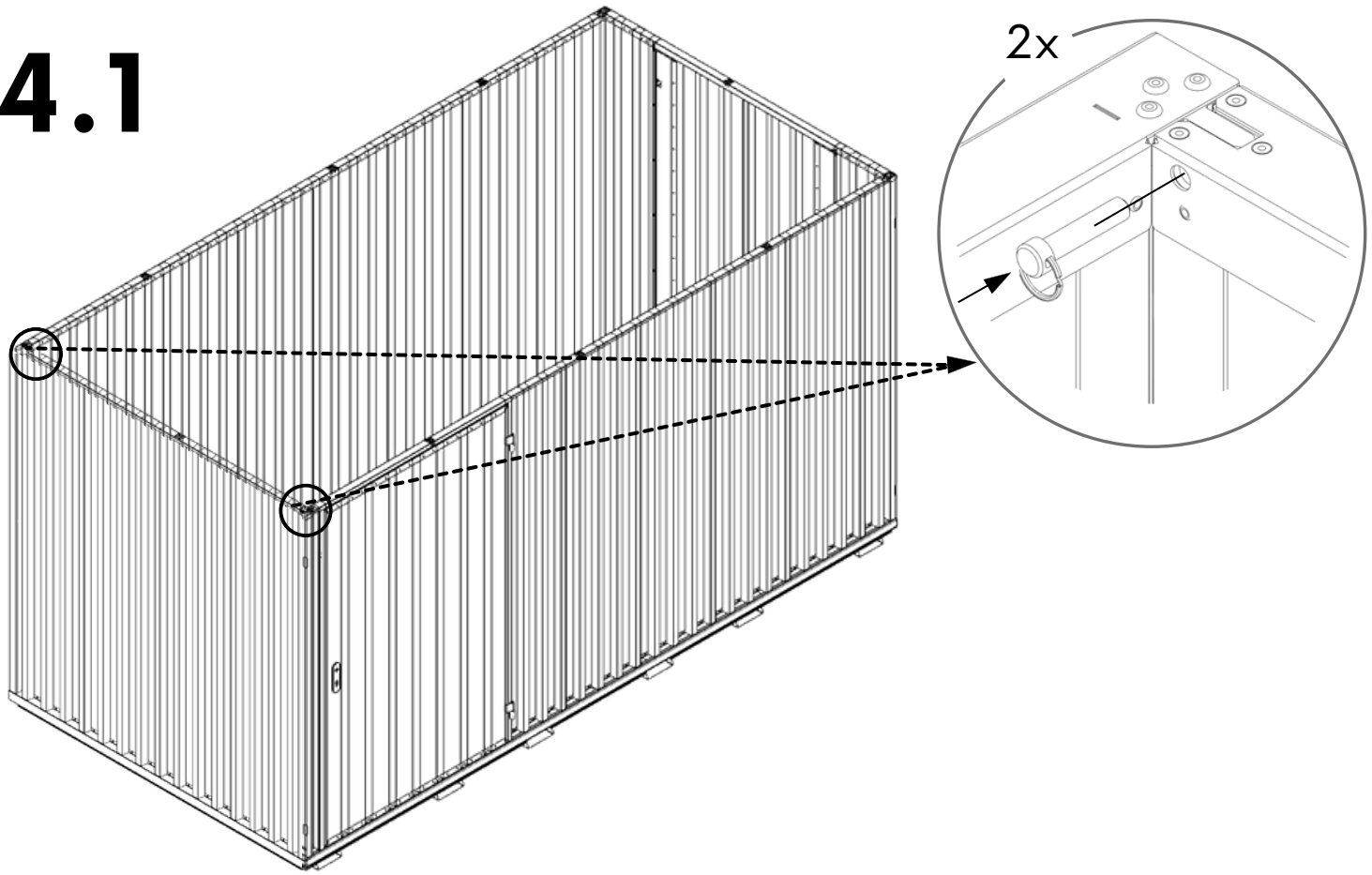

# 4



# 4.1



 336 KG	 3 TON	 1640 MM	Model Code: 30.110.440 Production Tracking Code: .....X09.1.30.440  9001  14001  50001	  
---	--	--	---	---

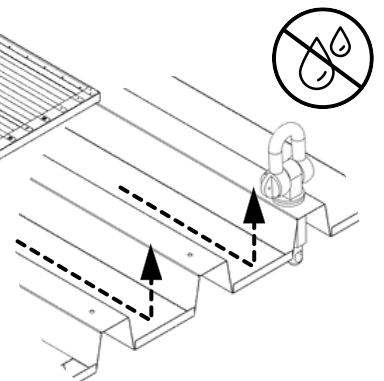
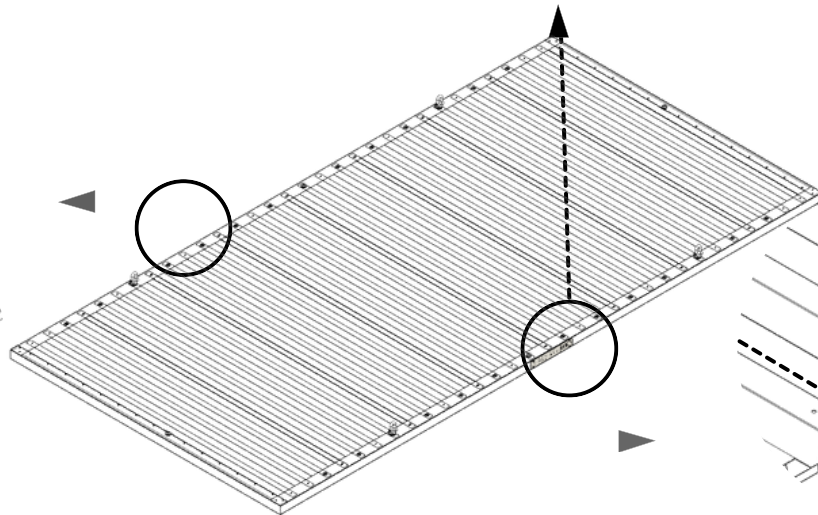
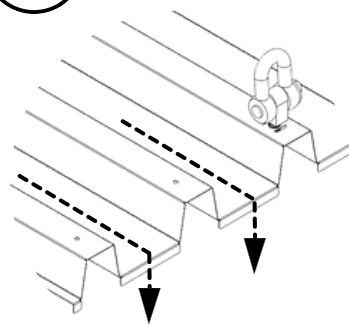

# 5

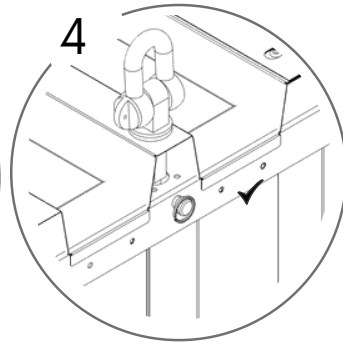
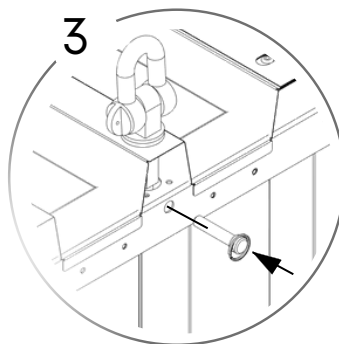
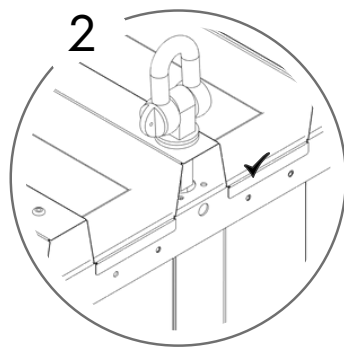
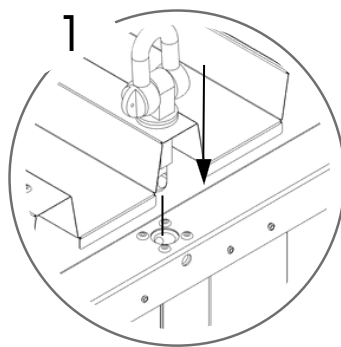
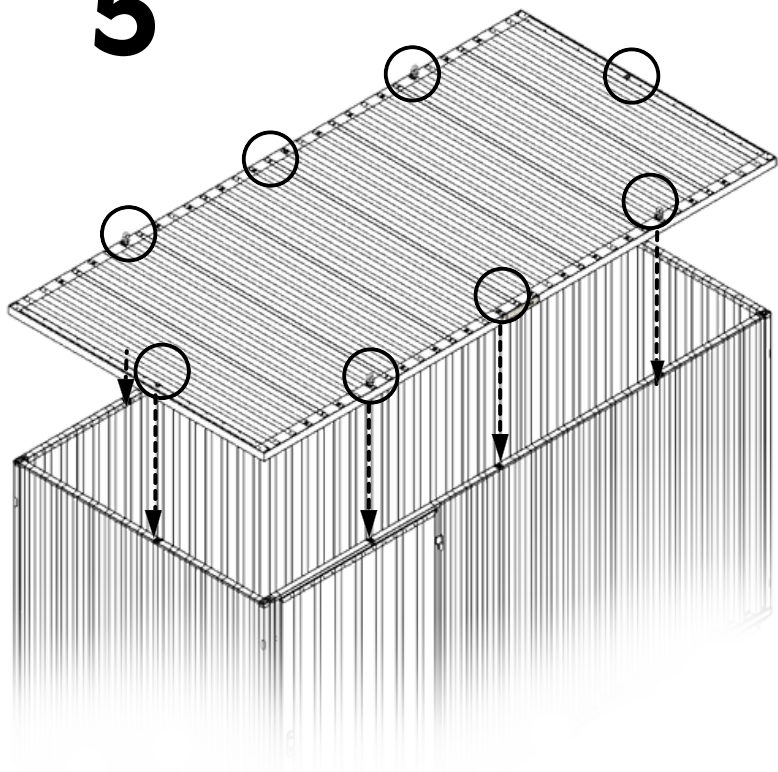

# 6

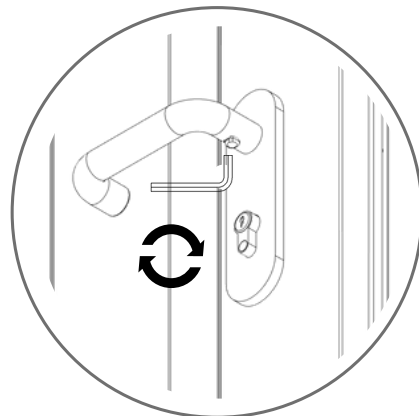
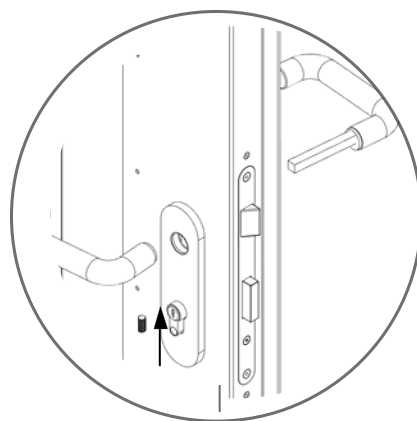
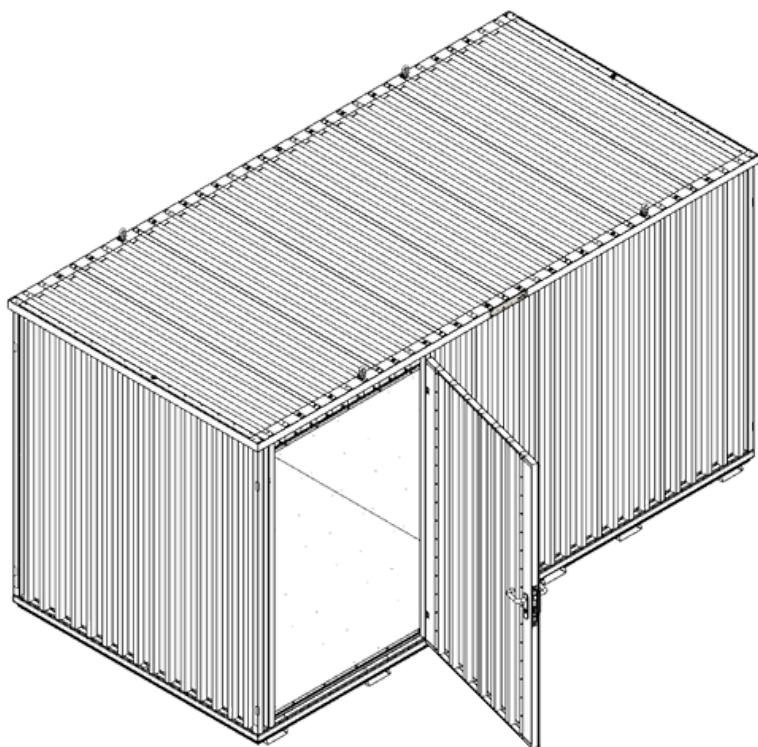

7

