

PRODUCT CODE: 40.110.320

prefabase
Quick Build Solutions

Instructions and User Guide

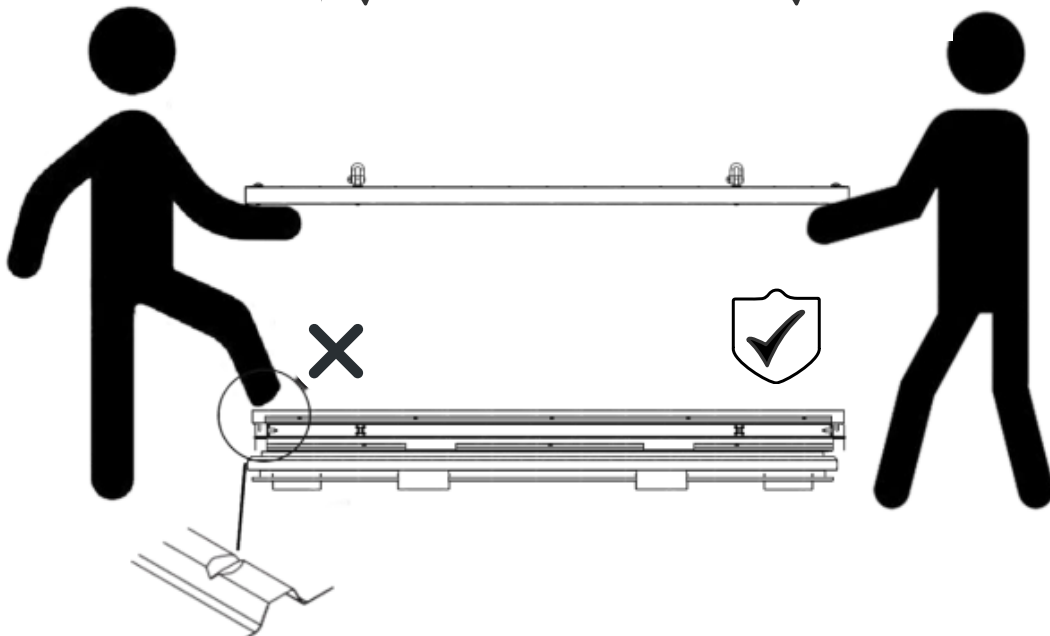
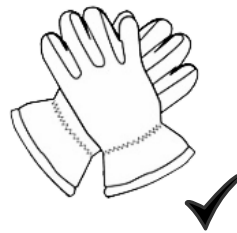

40.0110
1x

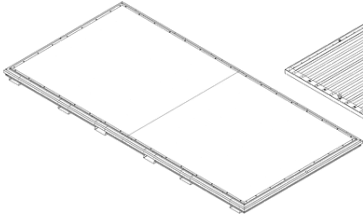

40.0510
1x

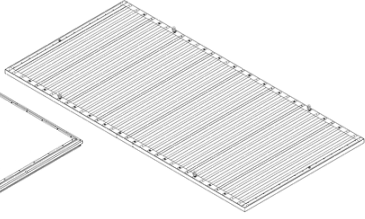

40.0410
2x

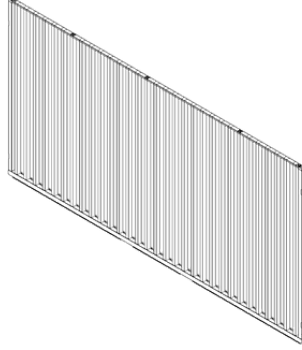

0310
1x

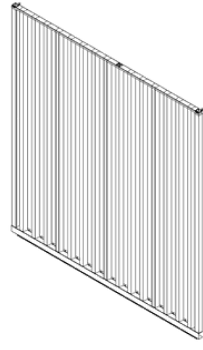

0320
1x



61.101
4x



12x

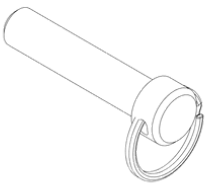

1x

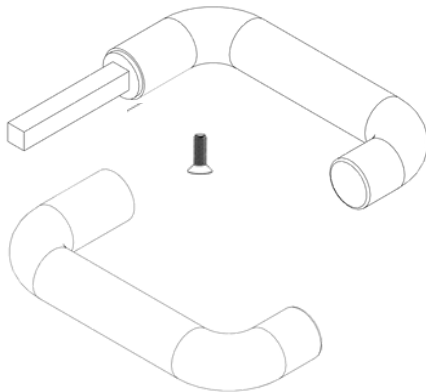

1x

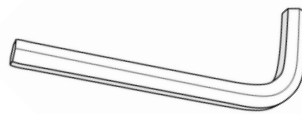

1x



1

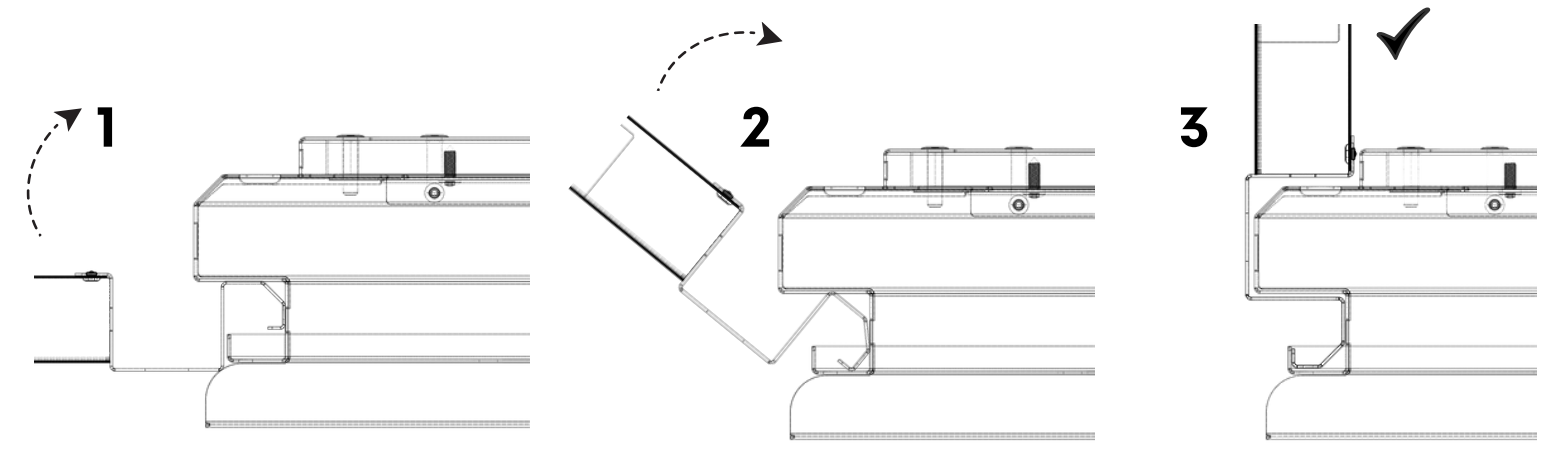
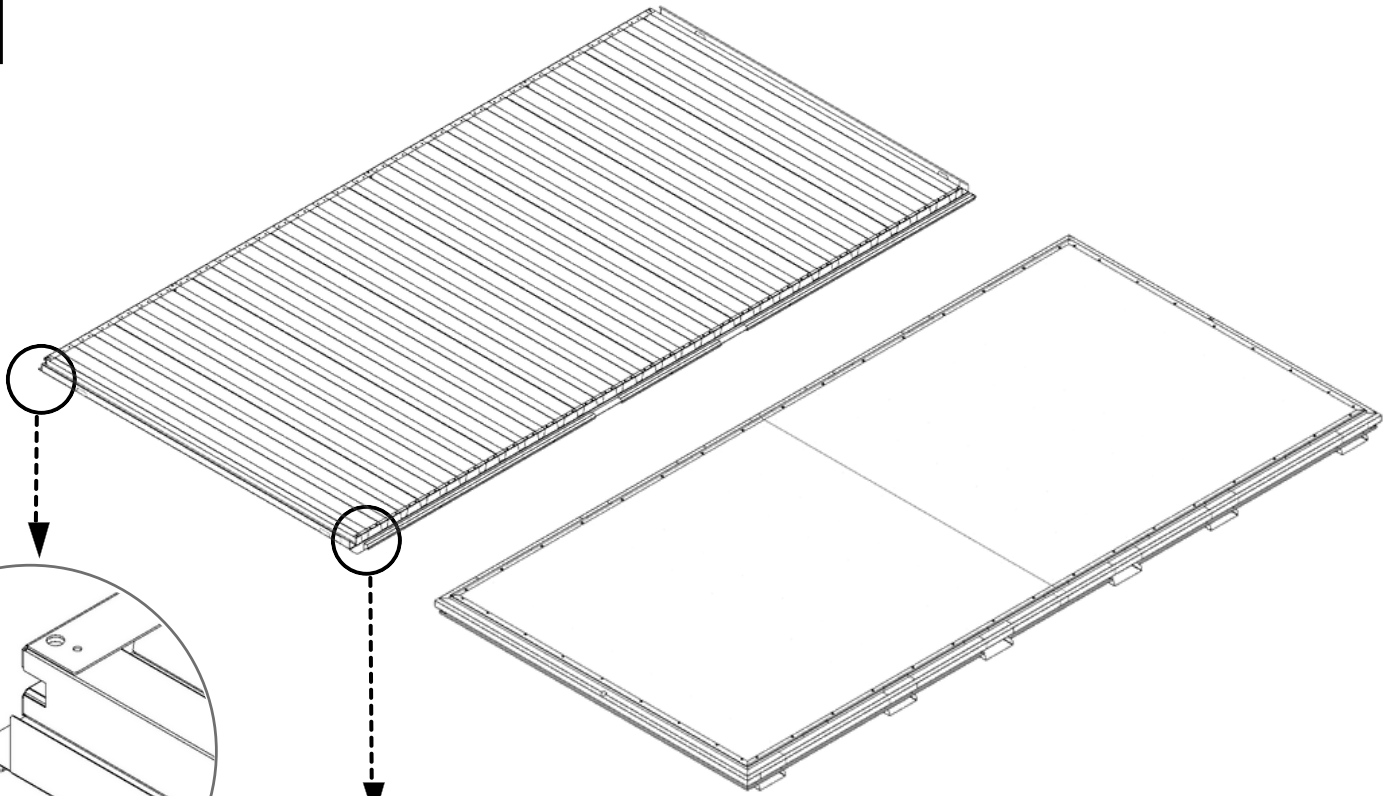

2

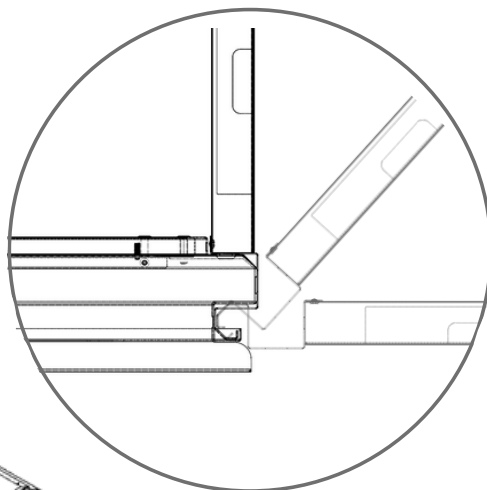
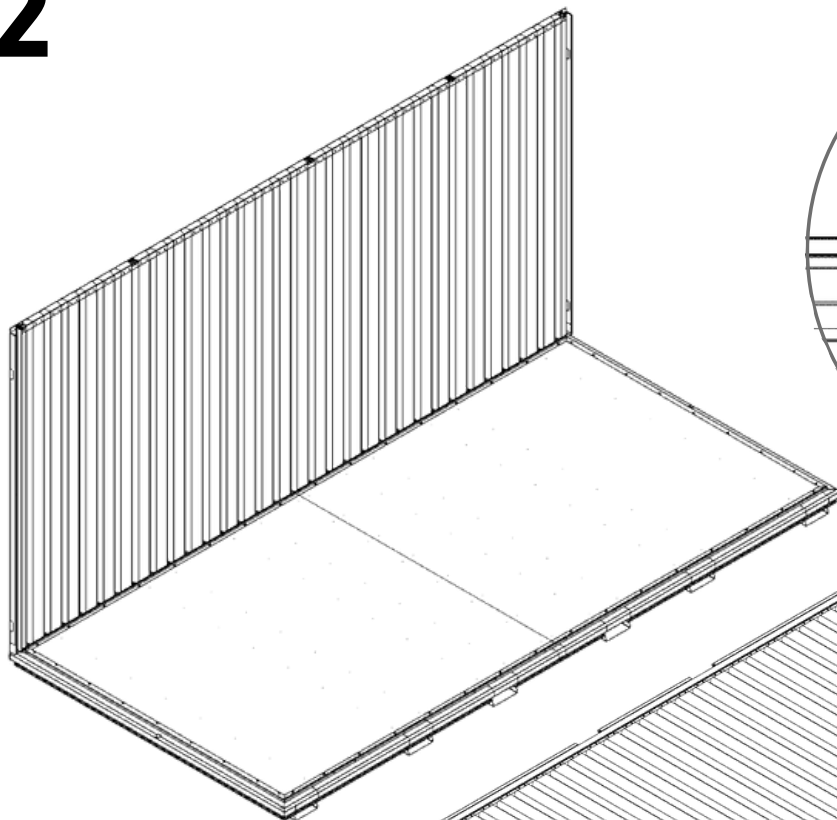

3

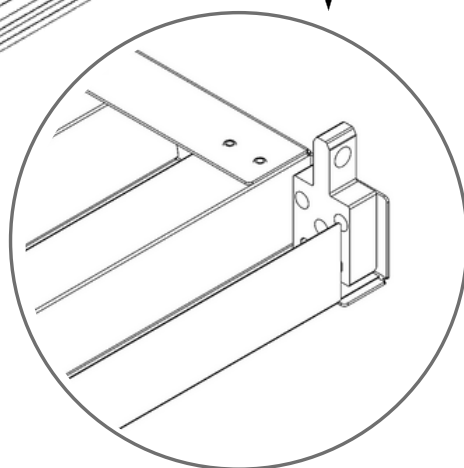
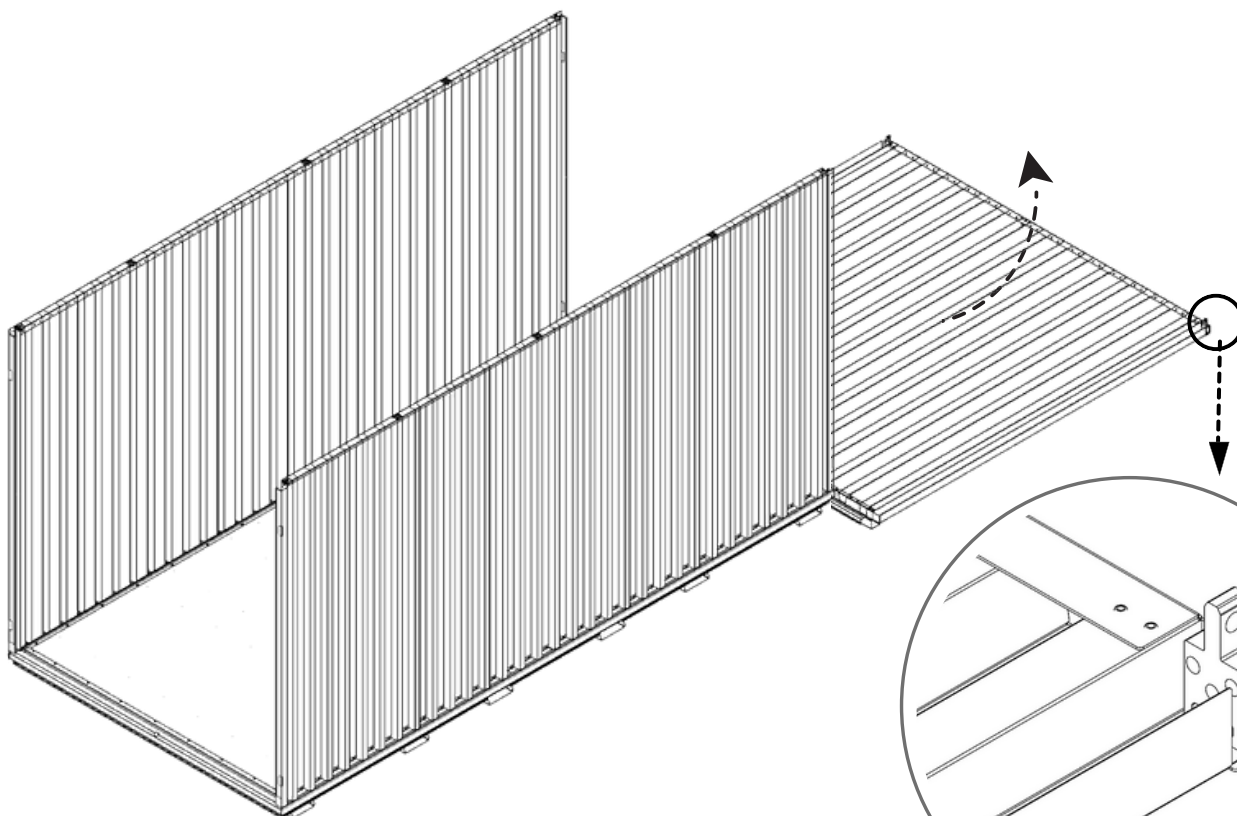
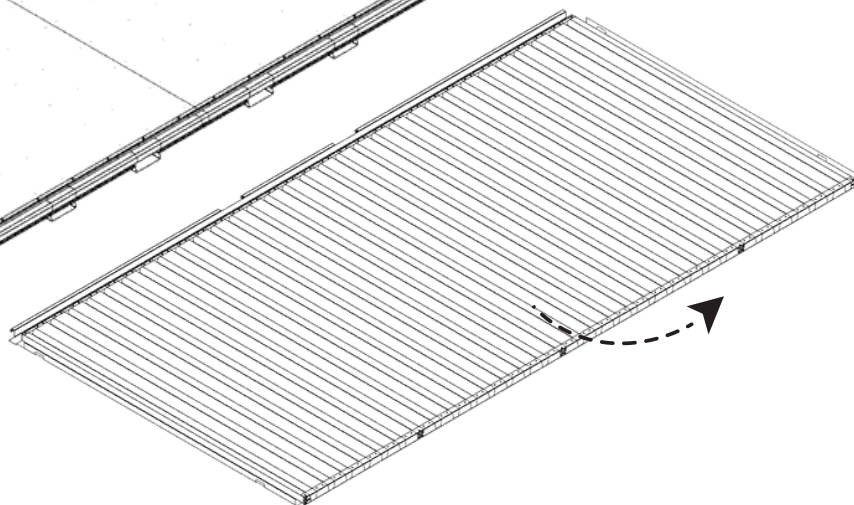

3.1

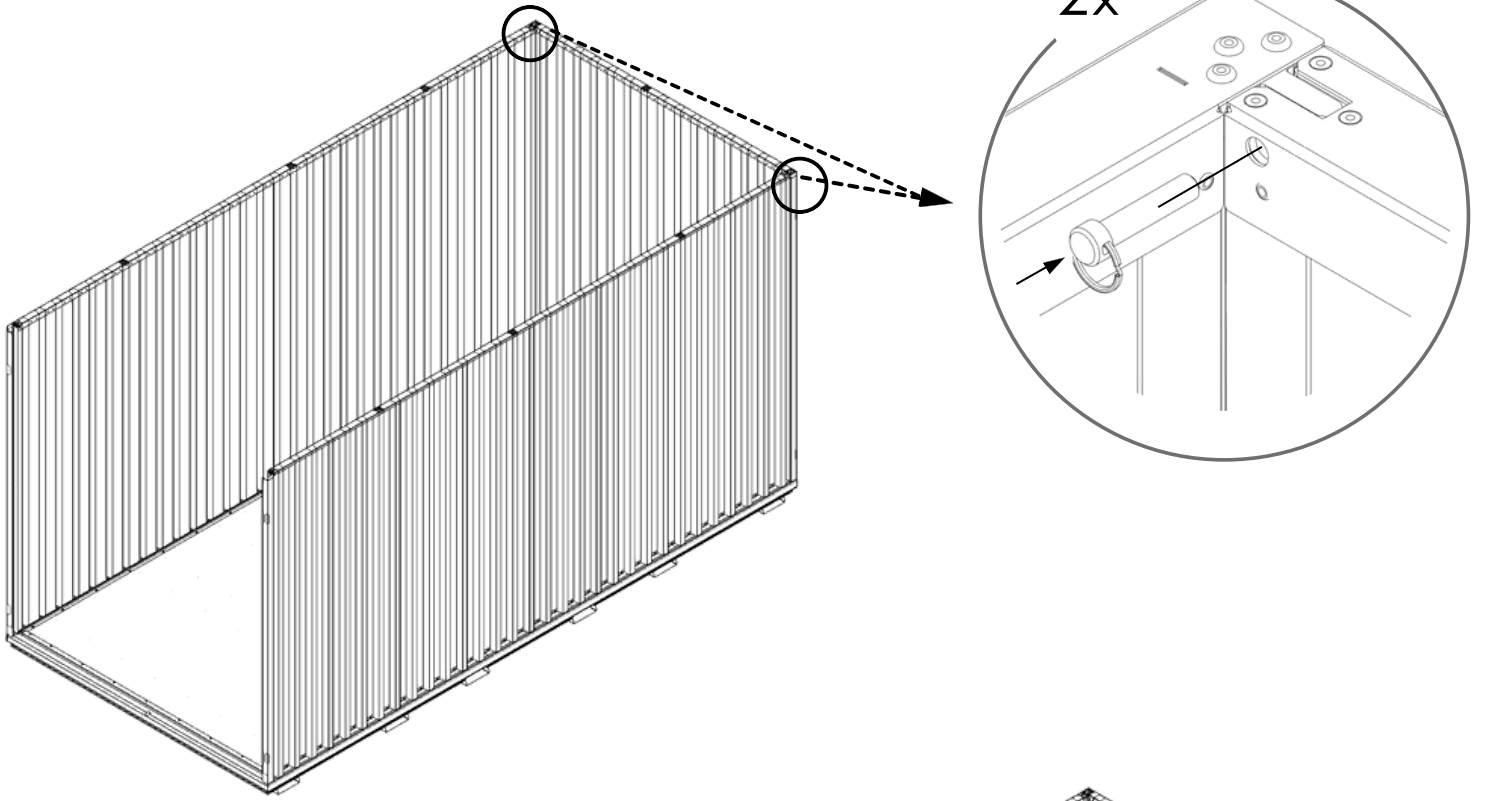



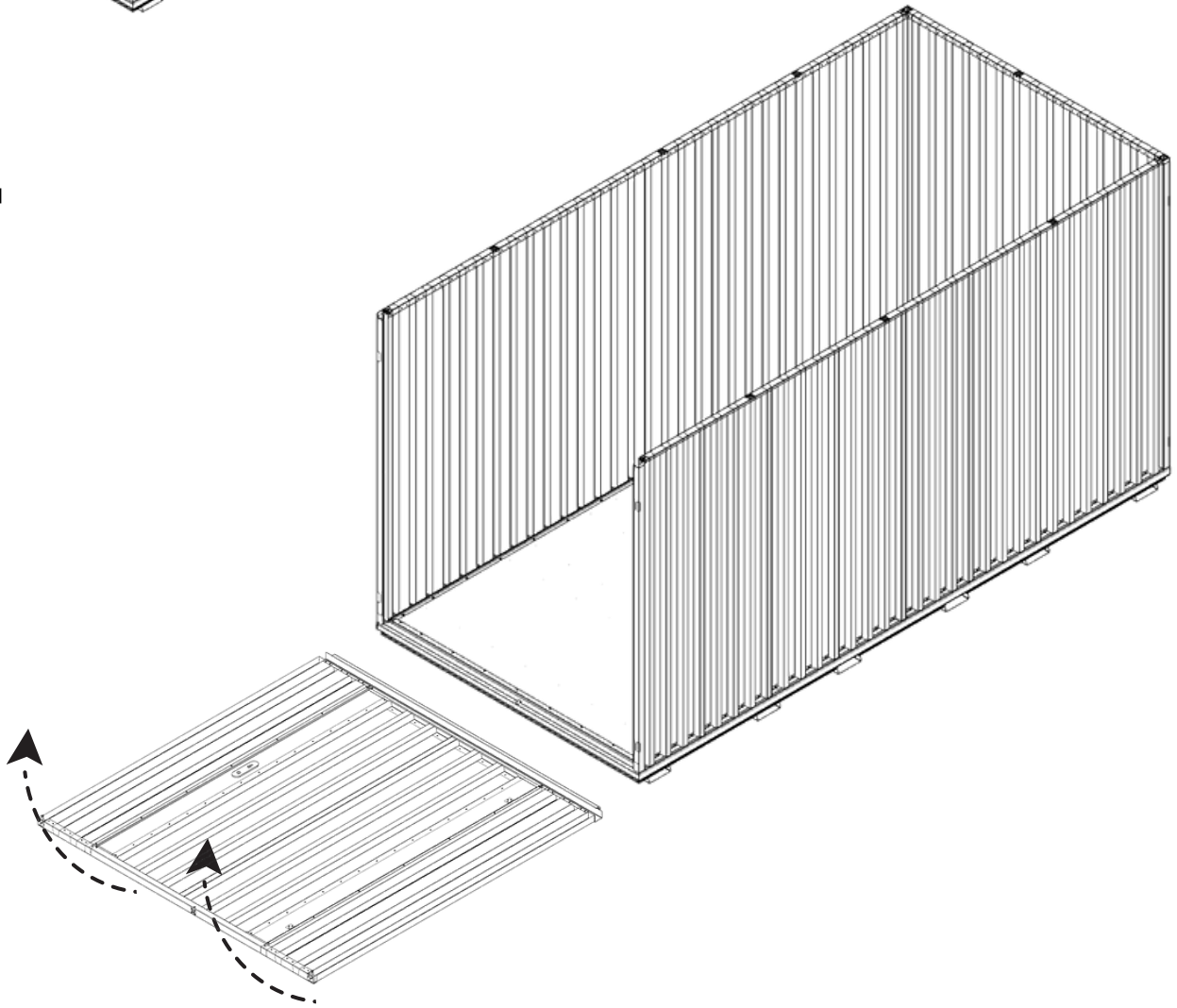



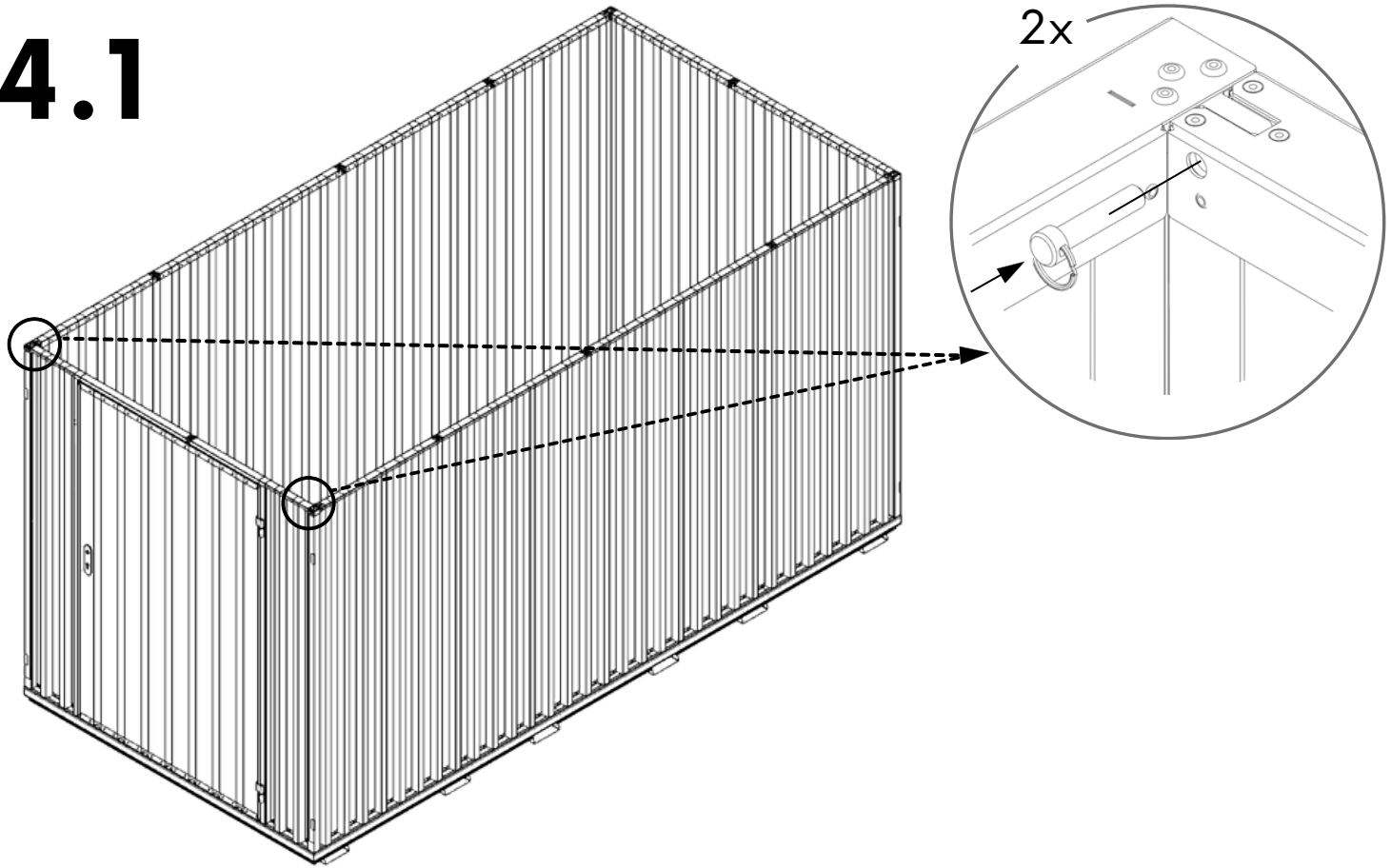

4



4.1



 422 KG	 1640 MM	Model Code: 40.110.320 Production Tracking Code: /X09.1.40.320  9001  14001  50001	 	
---	--	--	---	---

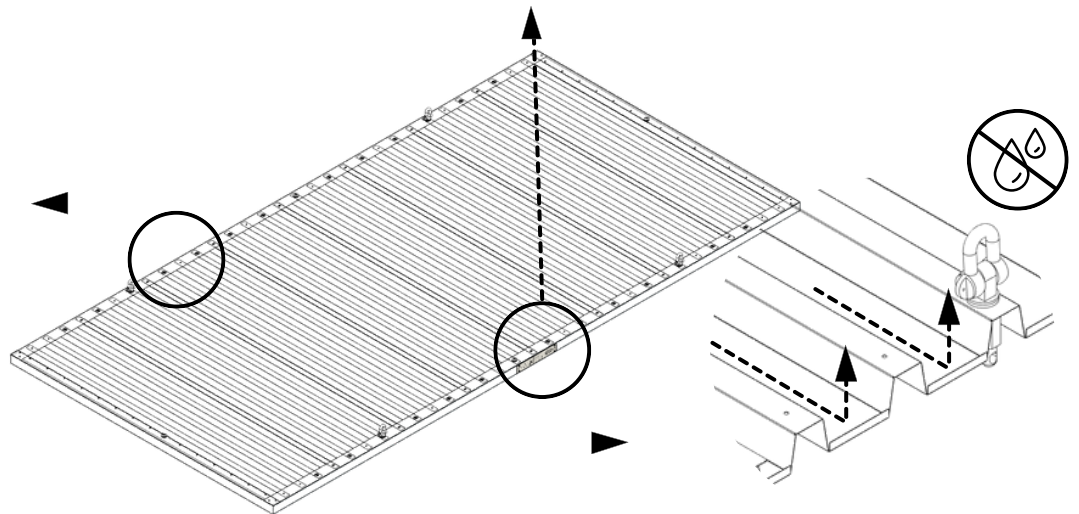
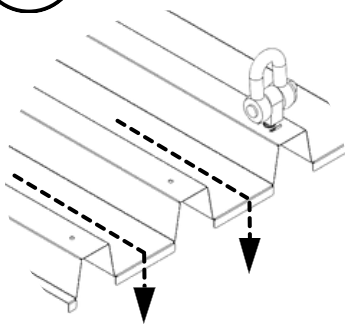

5

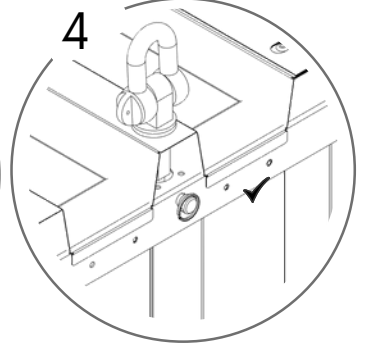
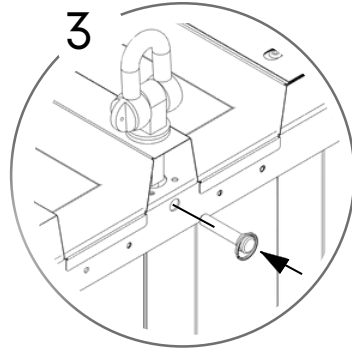
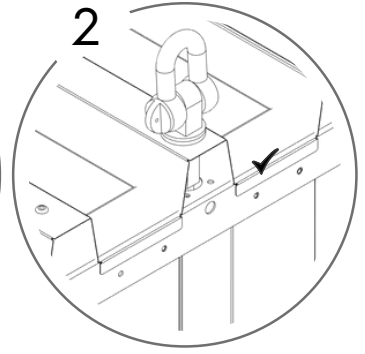
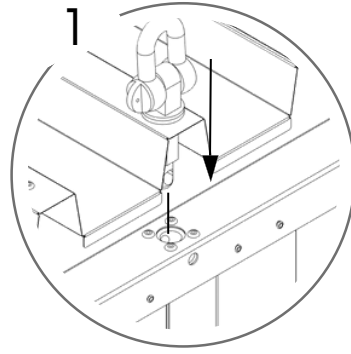
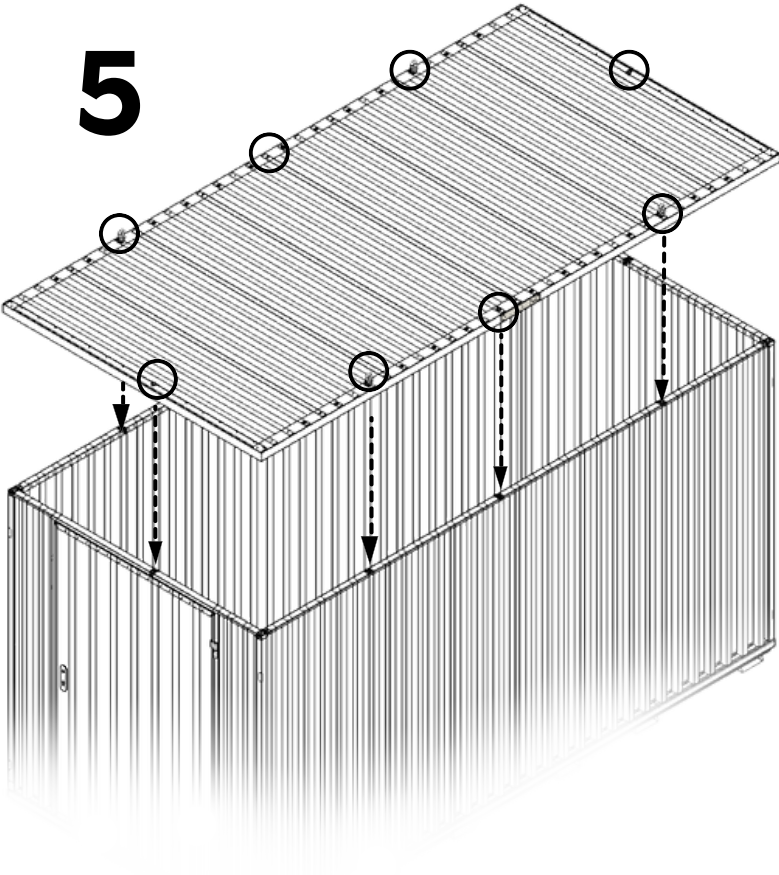

6

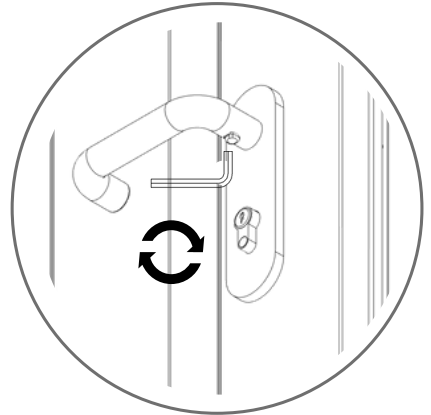
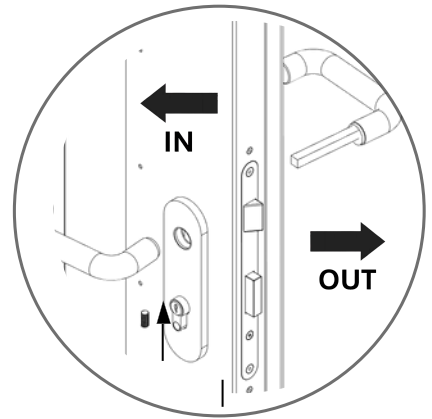

7

