







# PRODUCT CODE : 6060.110.450



	28 pcs.
	1 pcs.
	1 pcs.
	10 pcs.
	10 pcs.
	10 pcs.

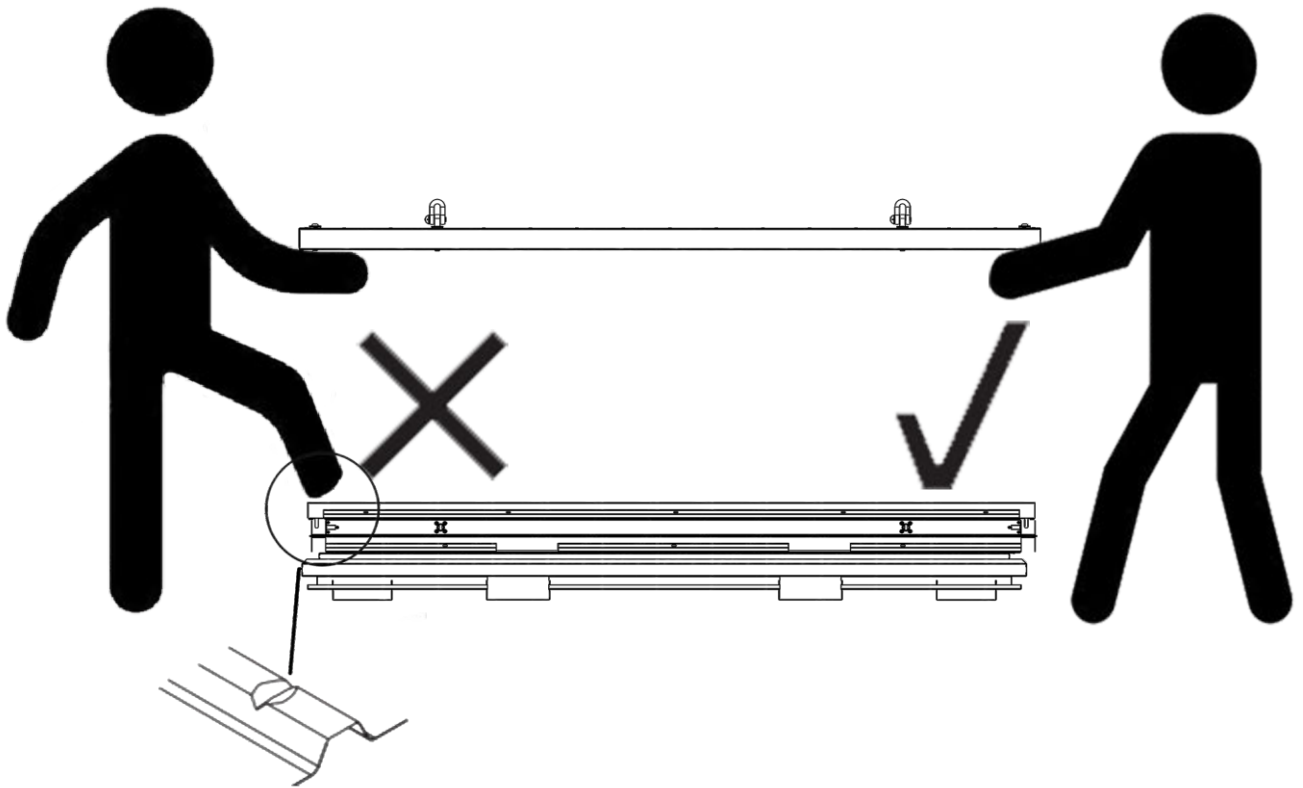
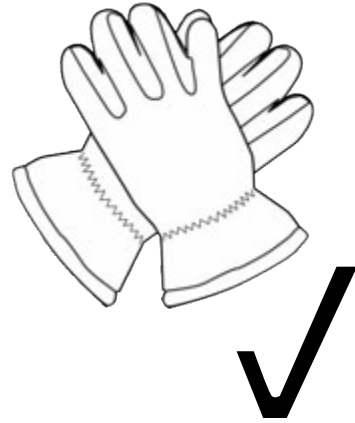

1.1.

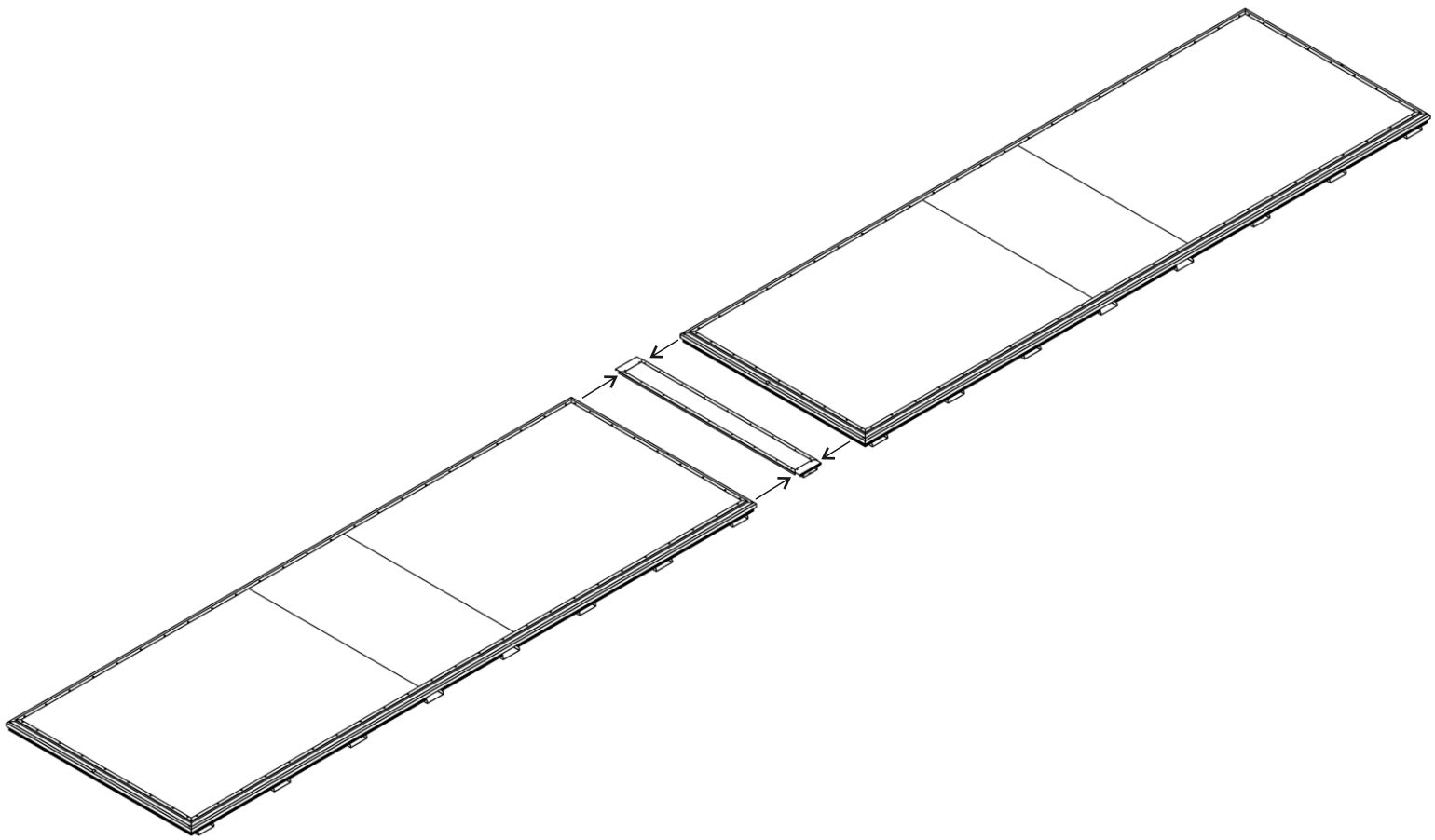

1.2.

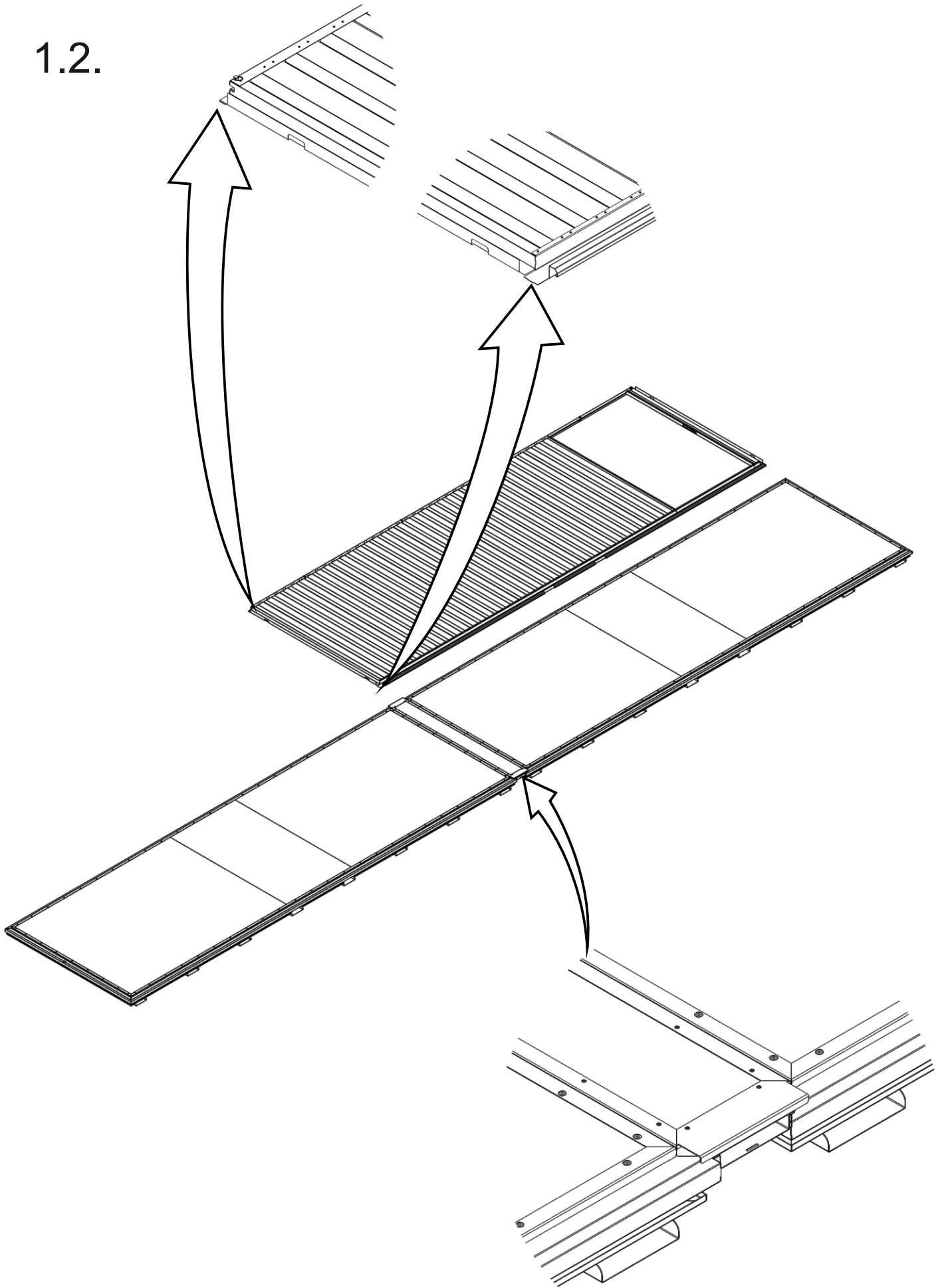

2.1.

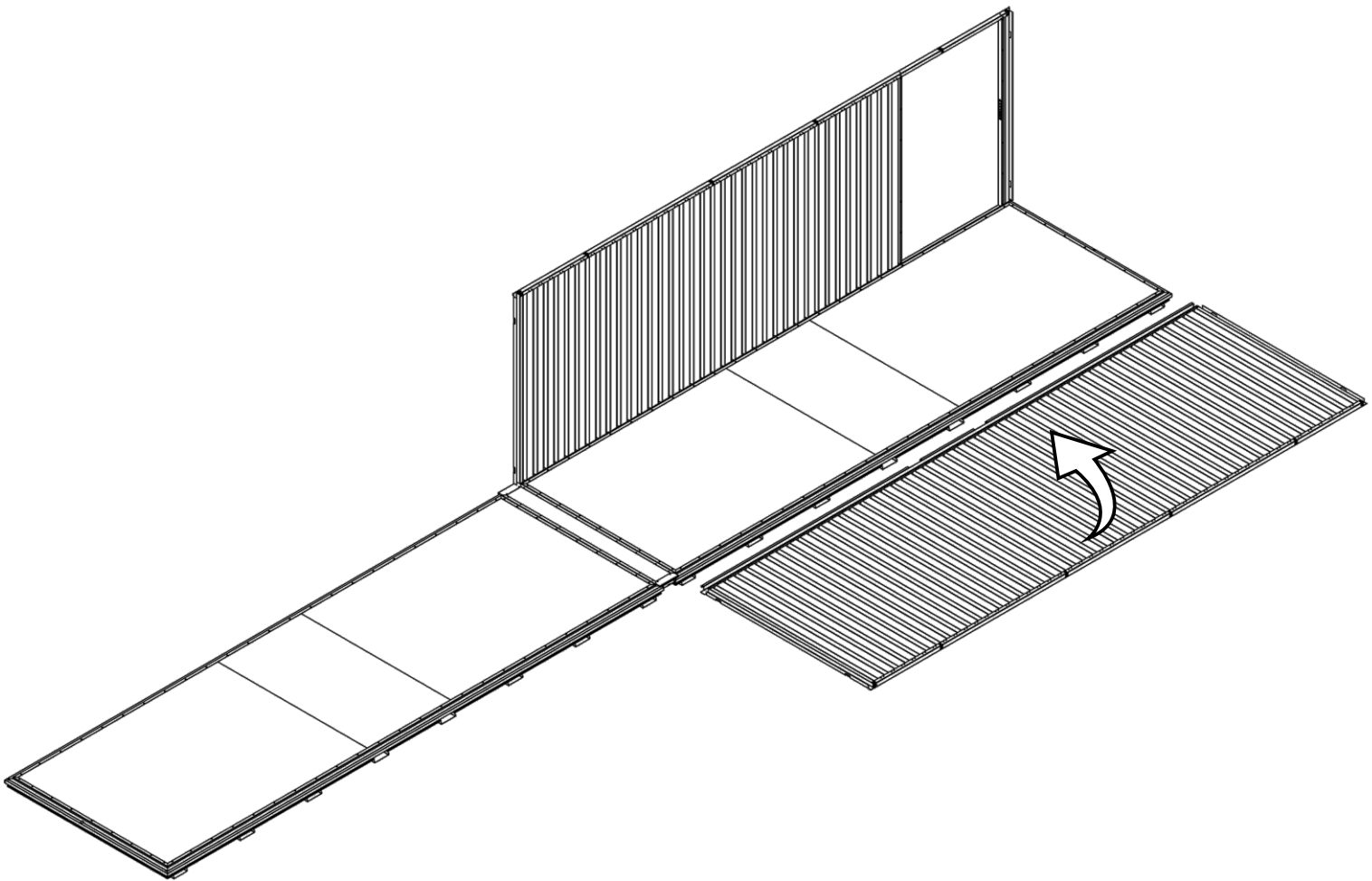
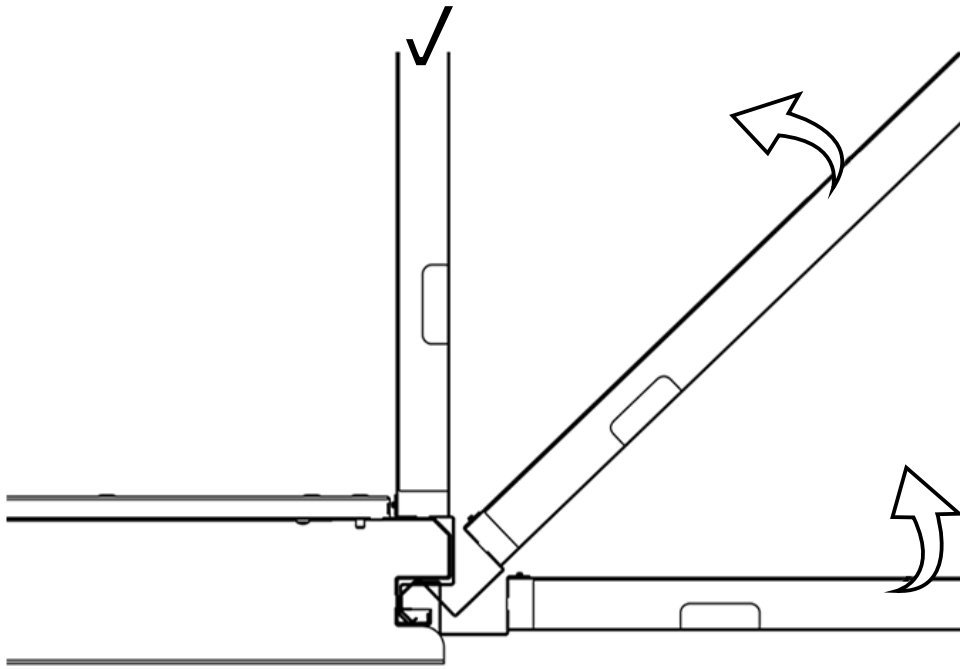

3.1.

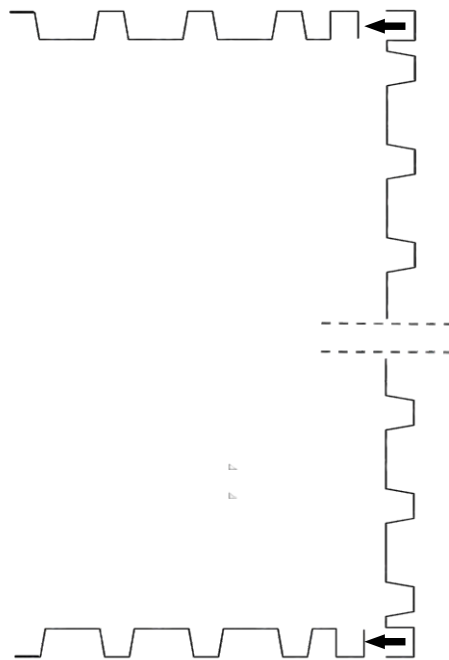
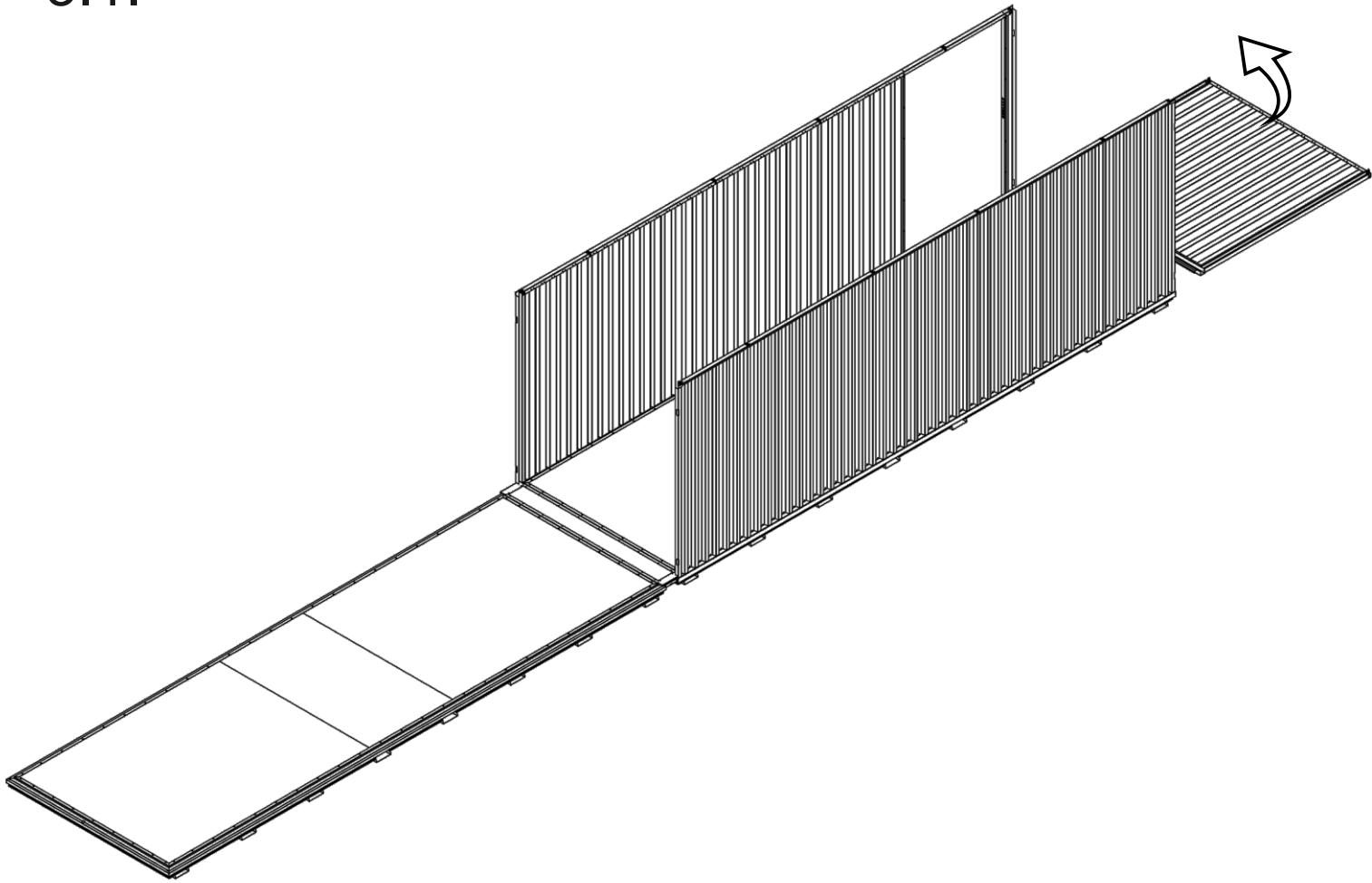

3.2.

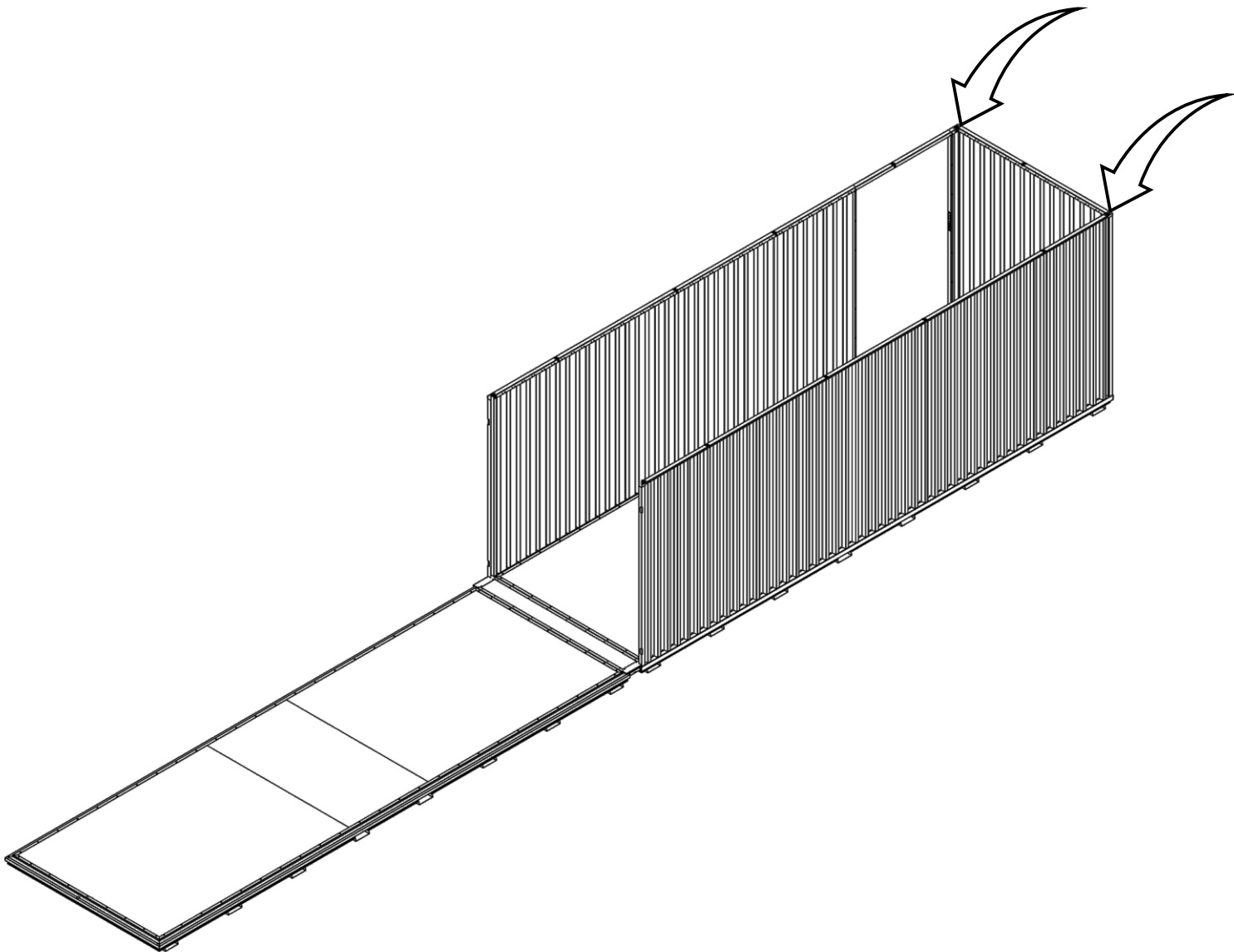
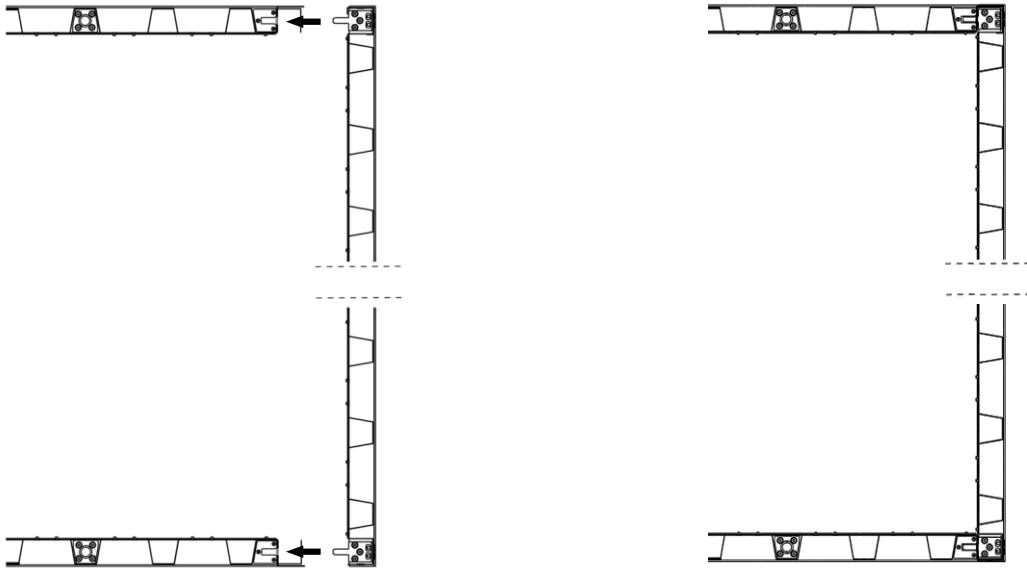

3.3.

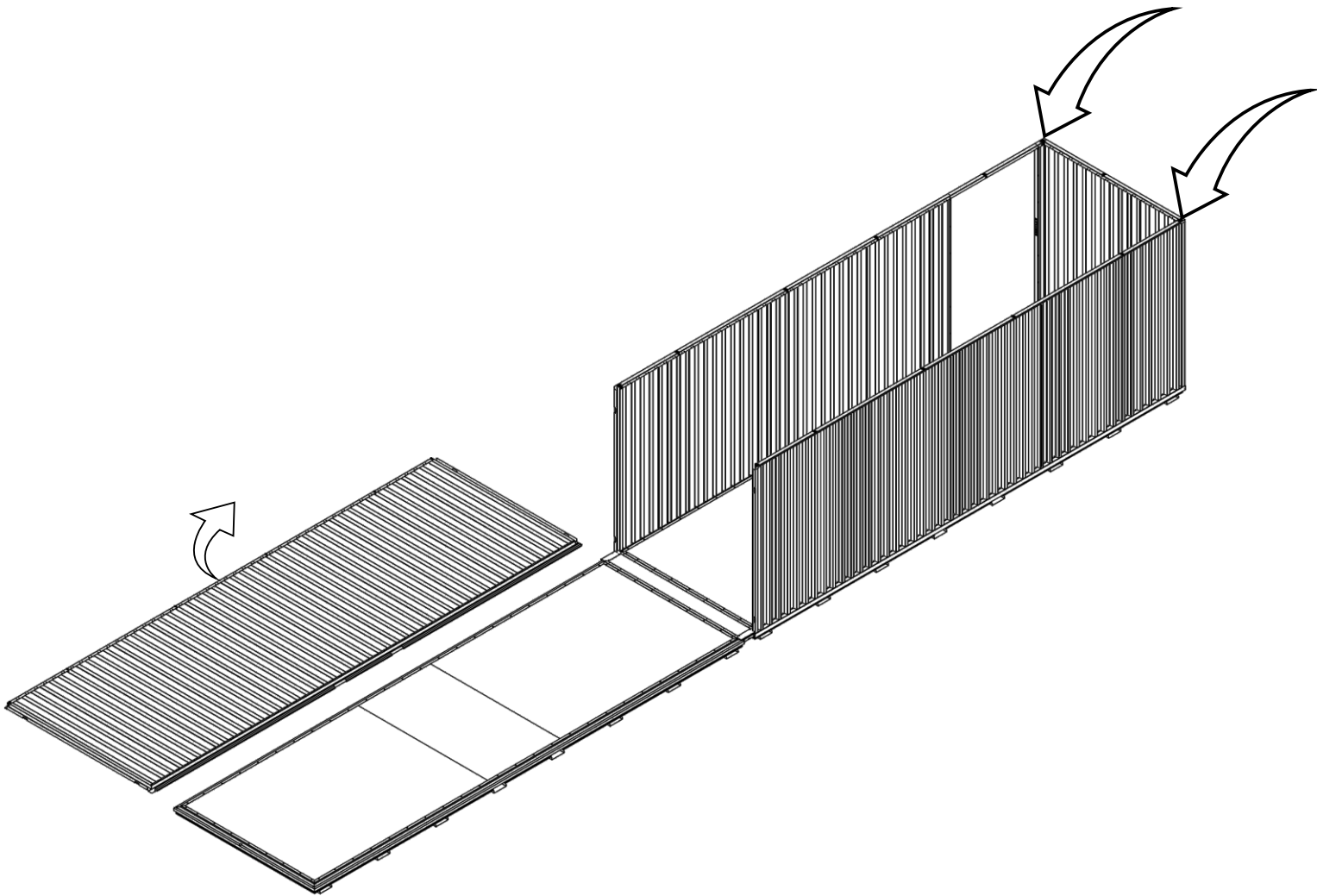
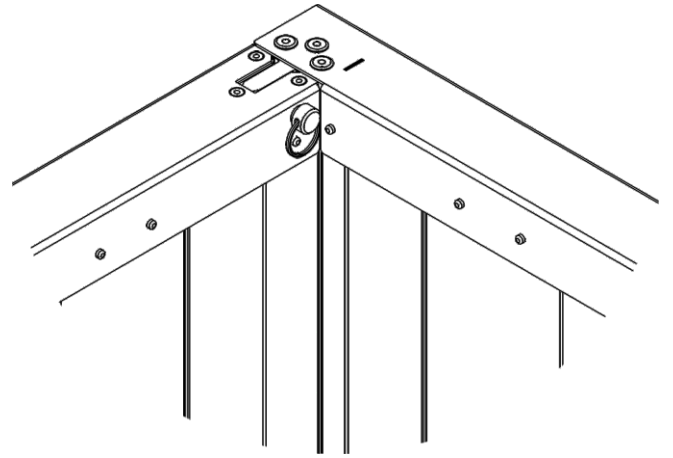
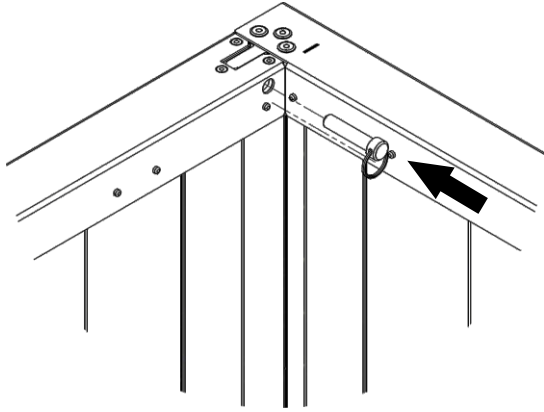



4.1.

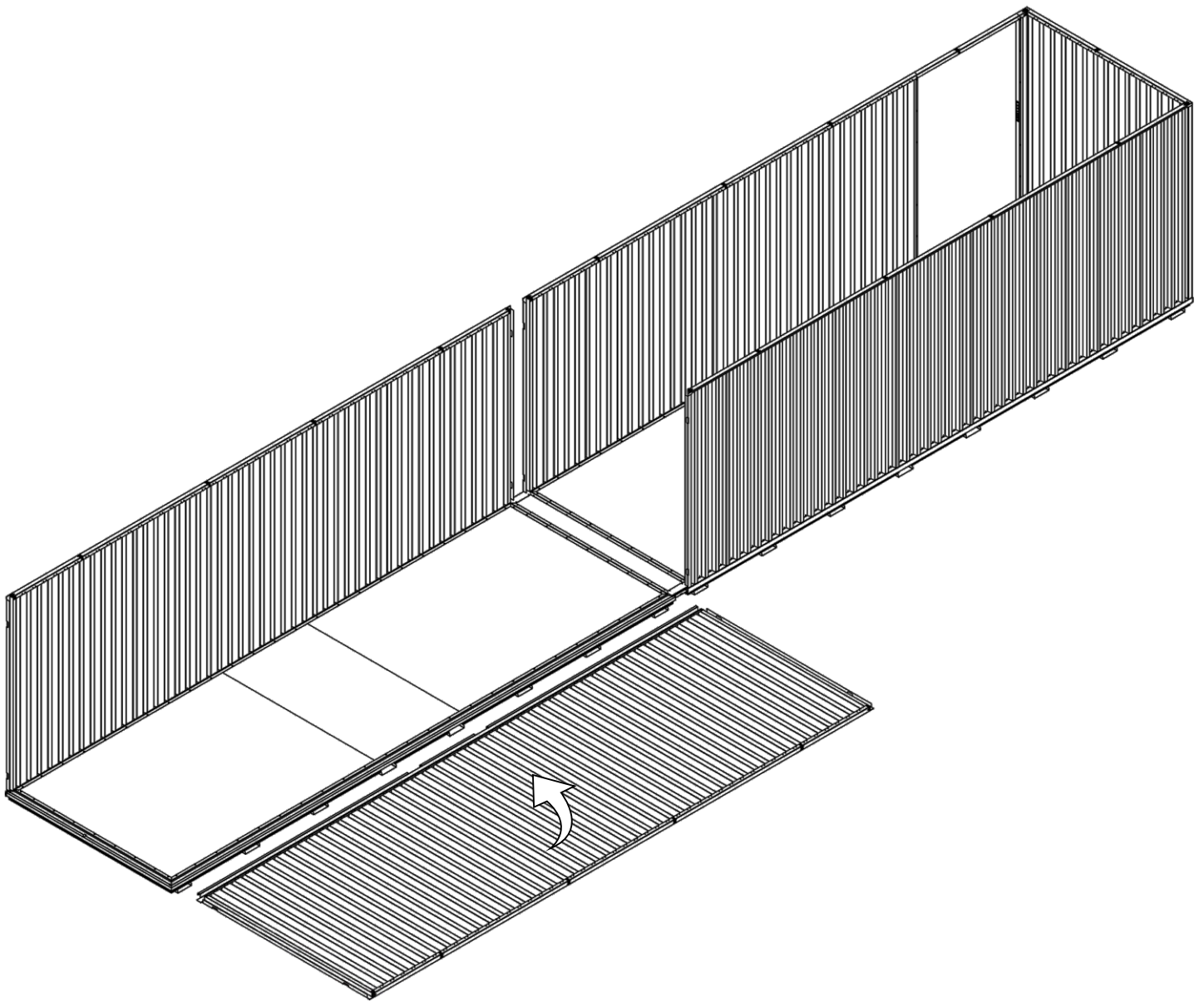

5.1.

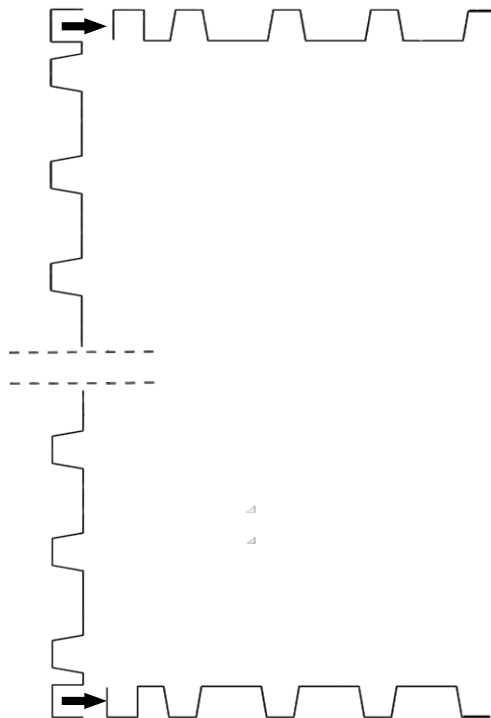
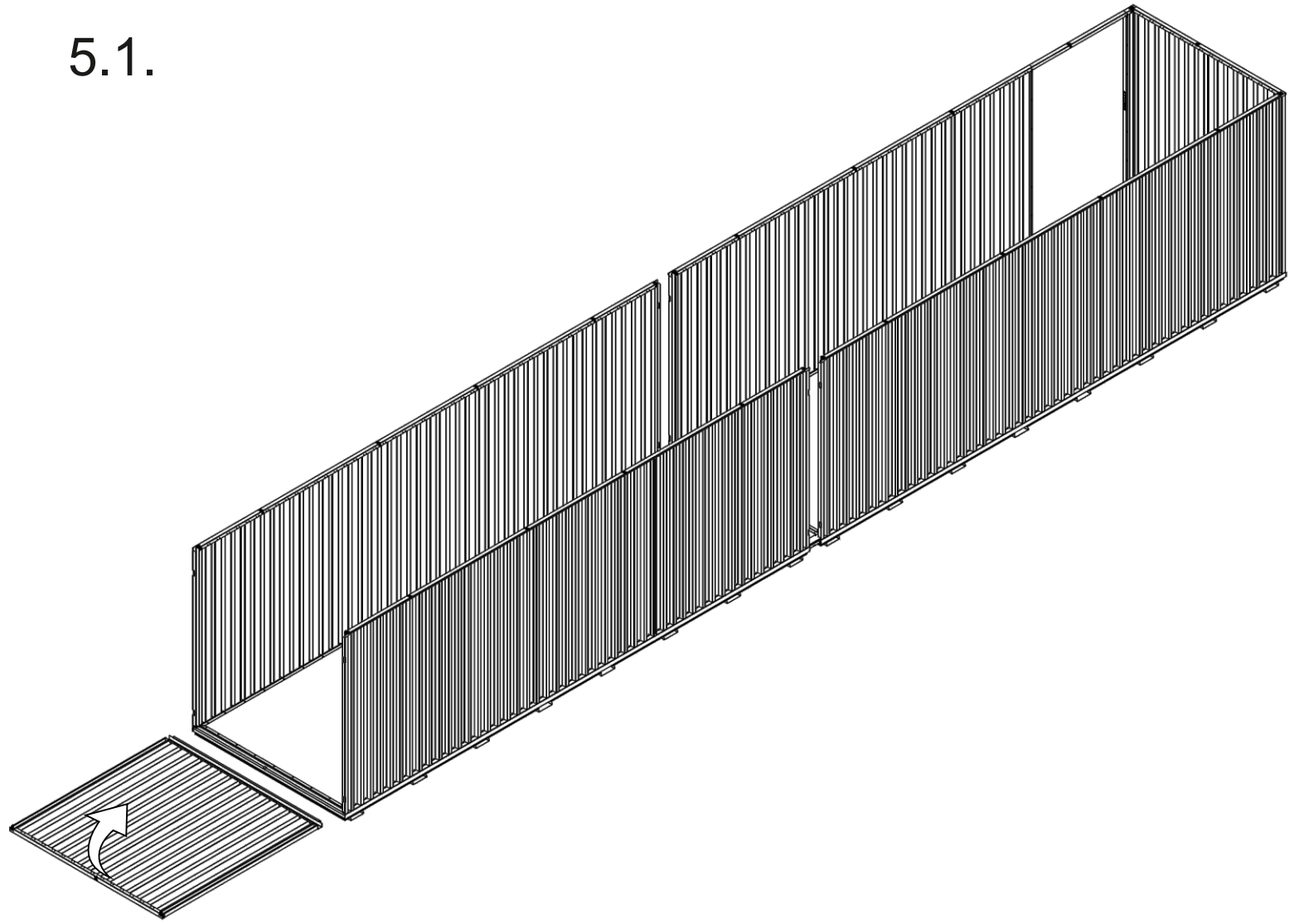

5.2.

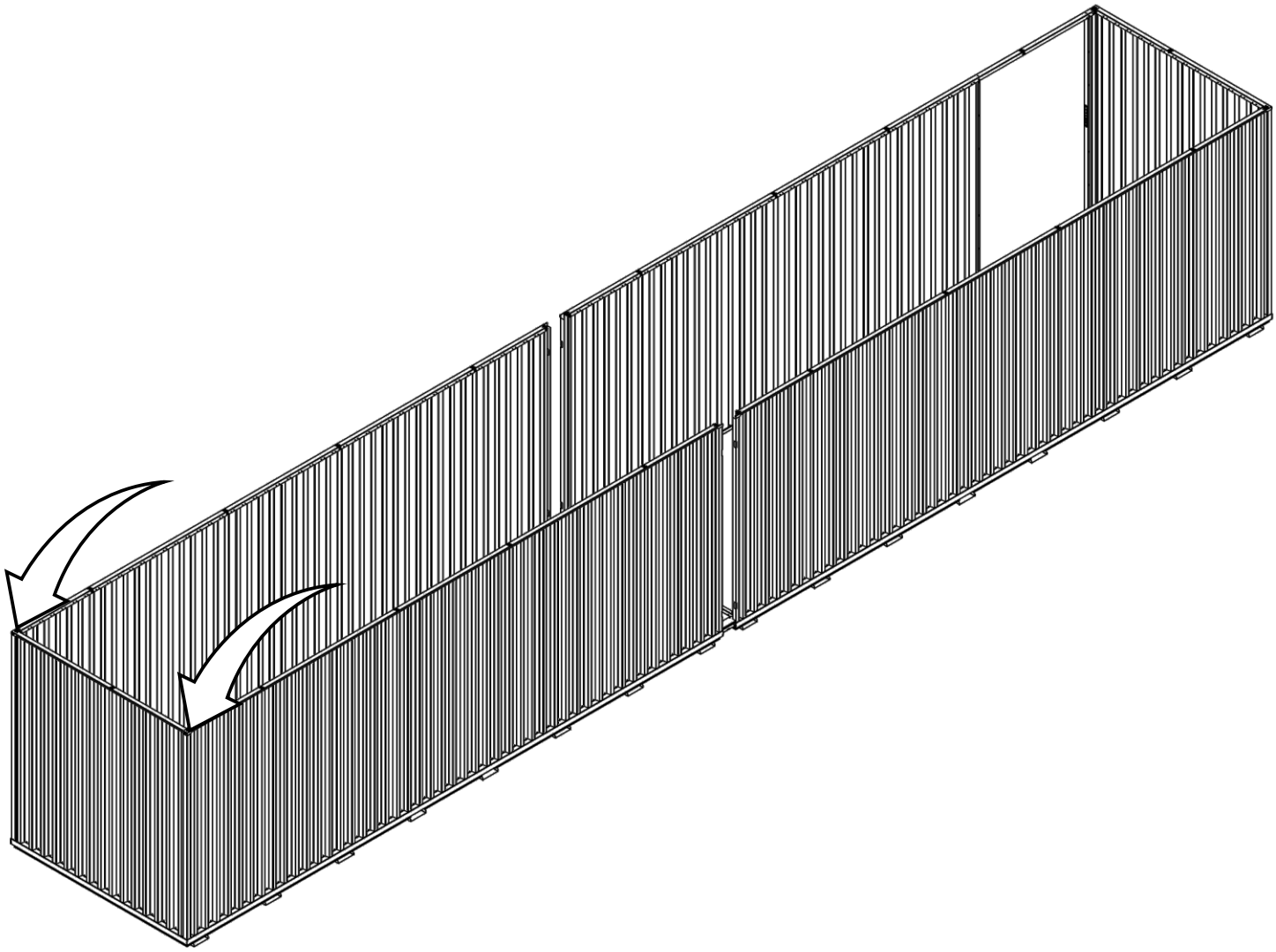
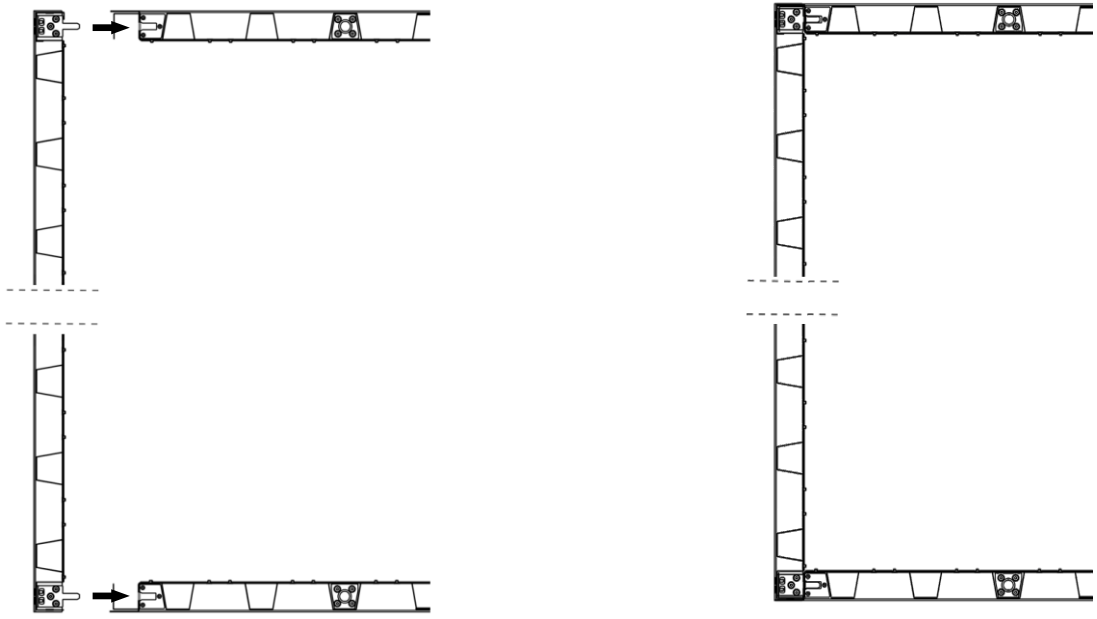

5.3.

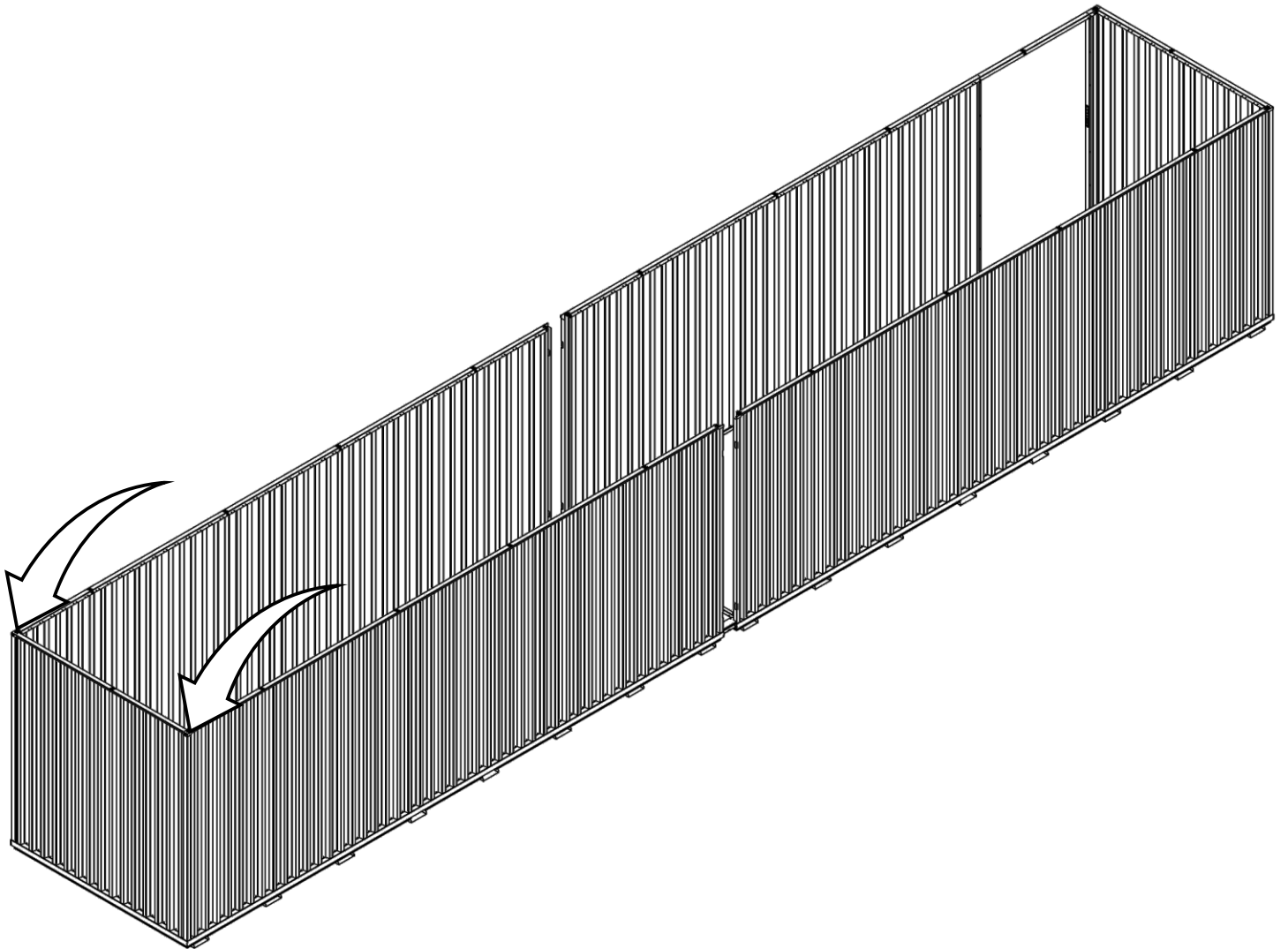
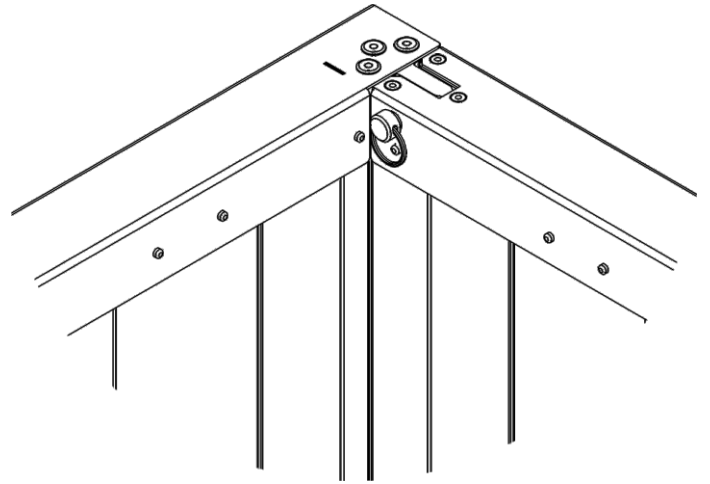
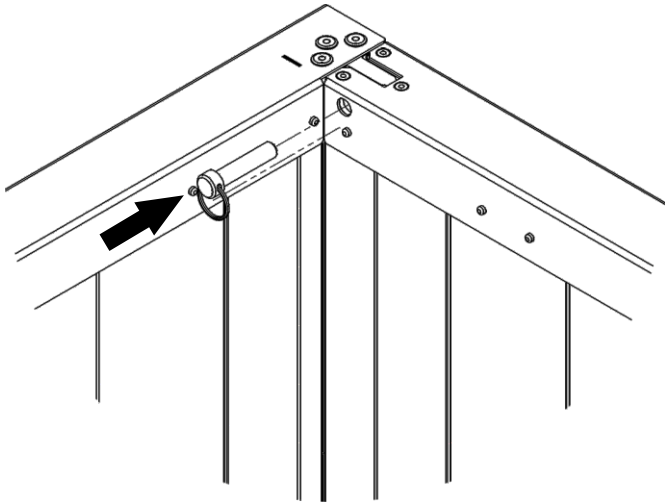

6.1.

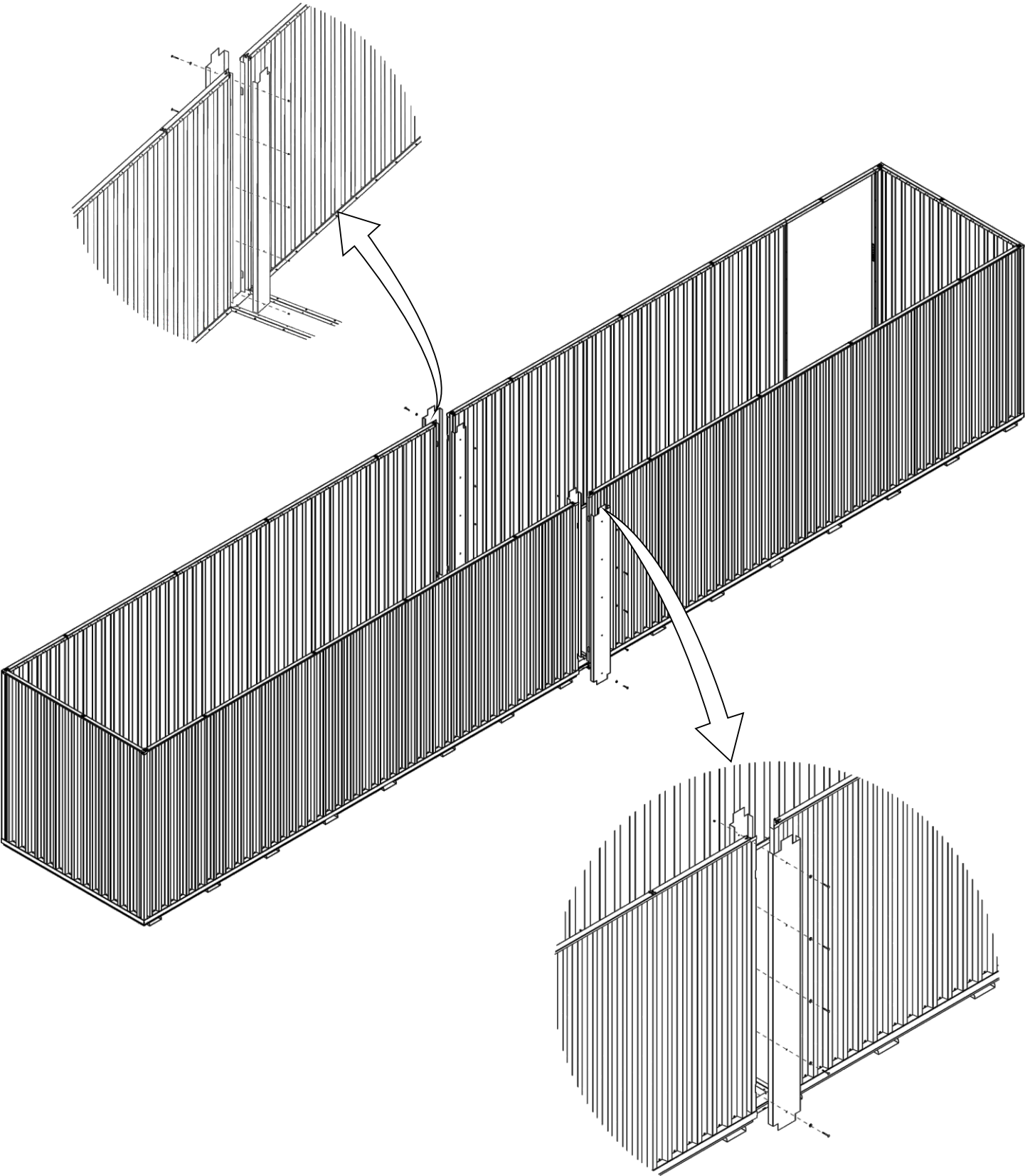

7.1.

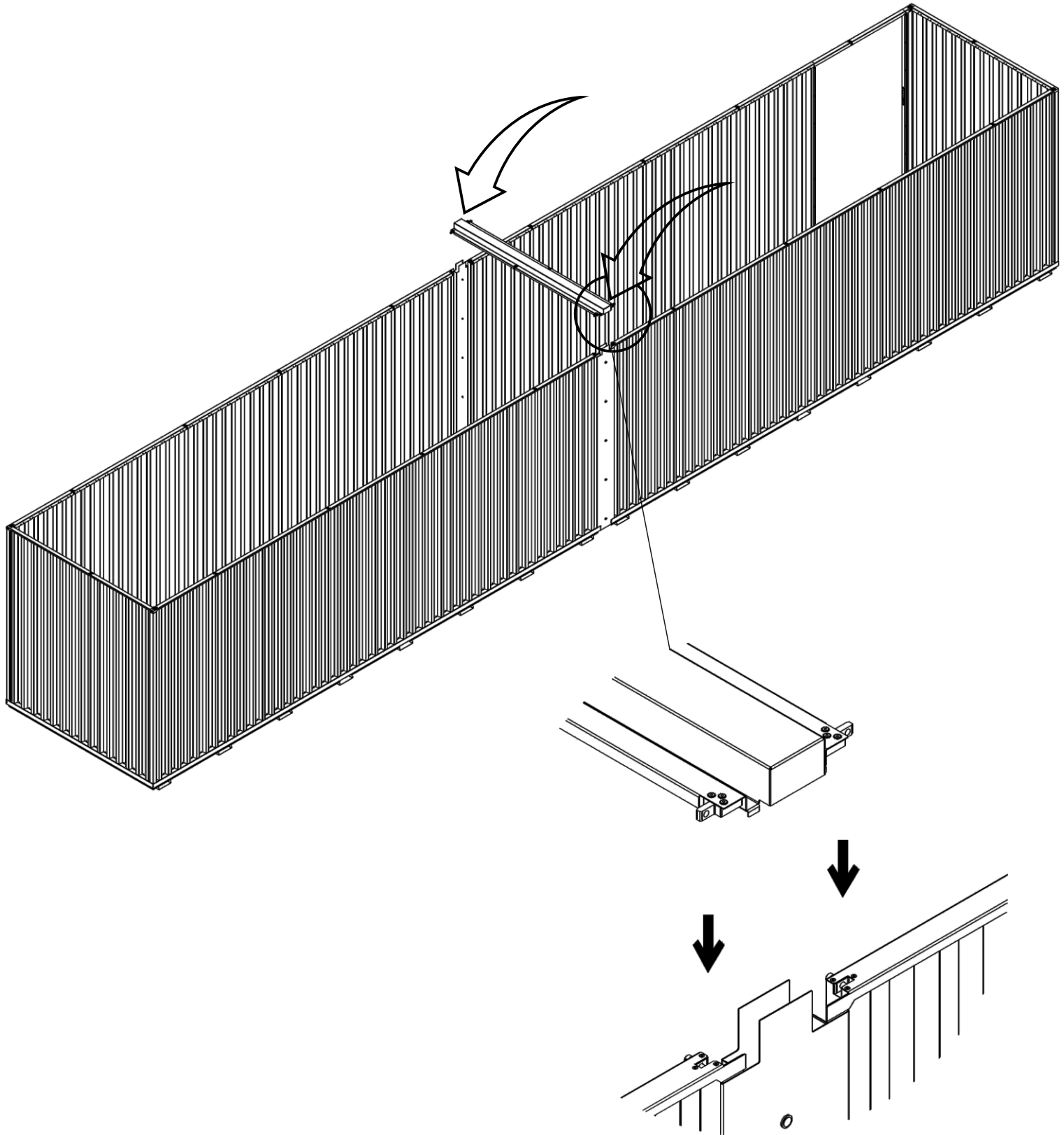

7.2.

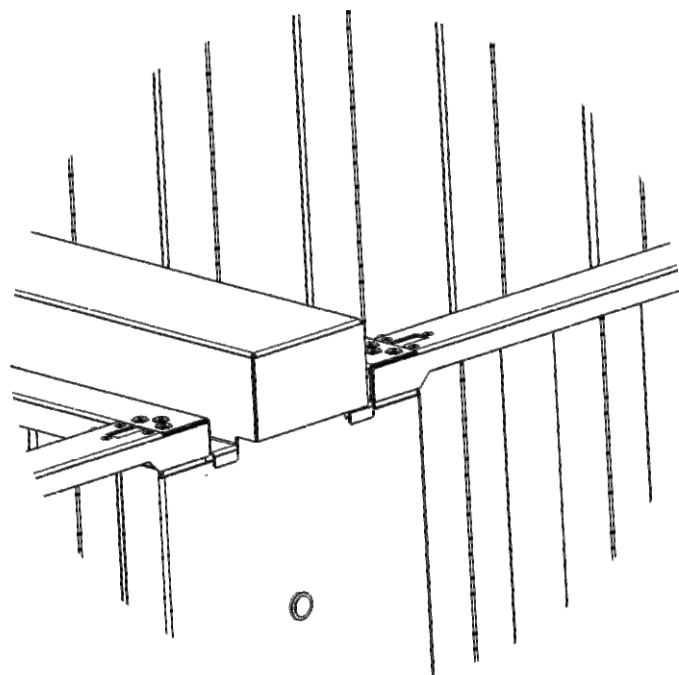
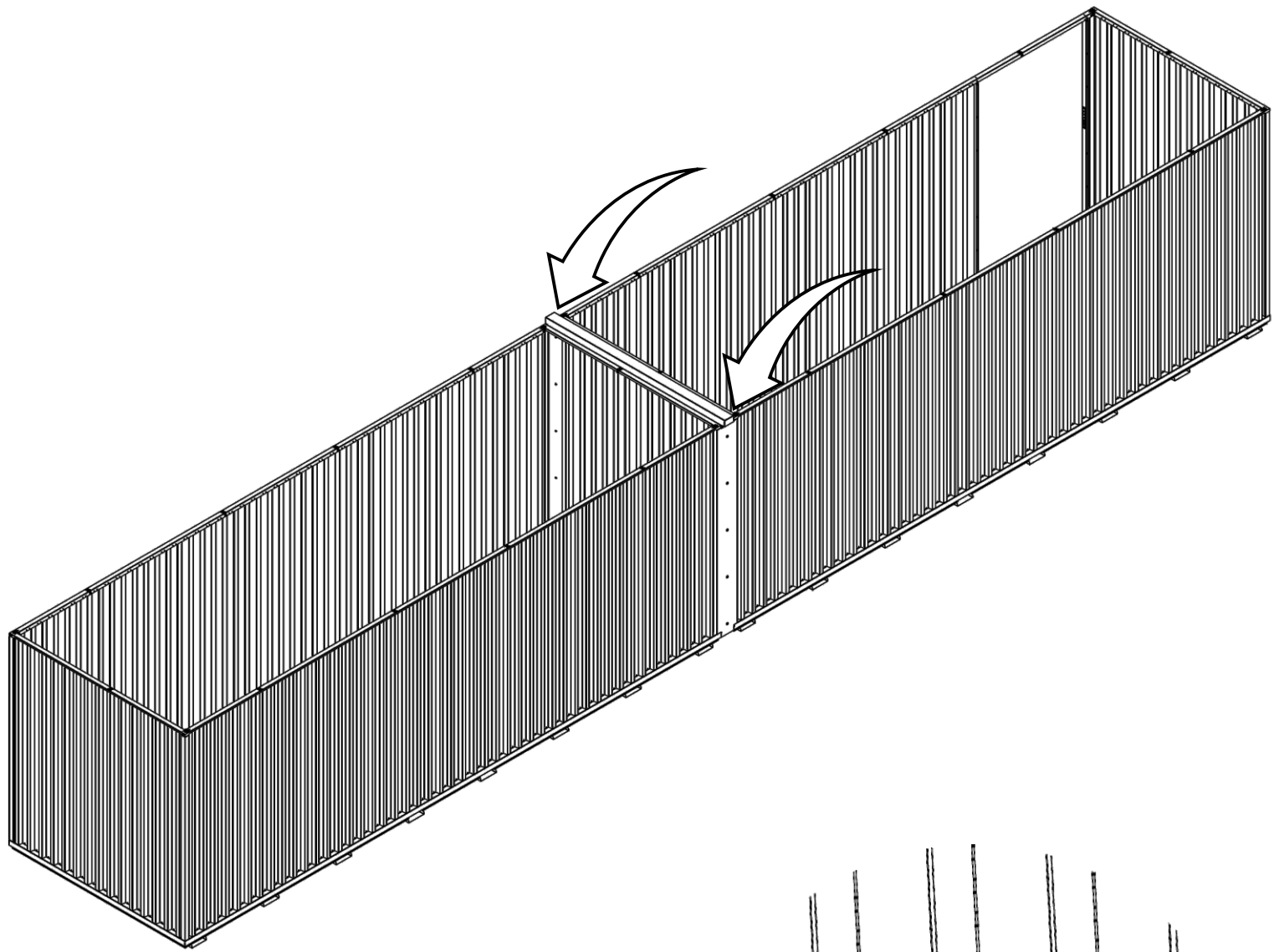

7.3.

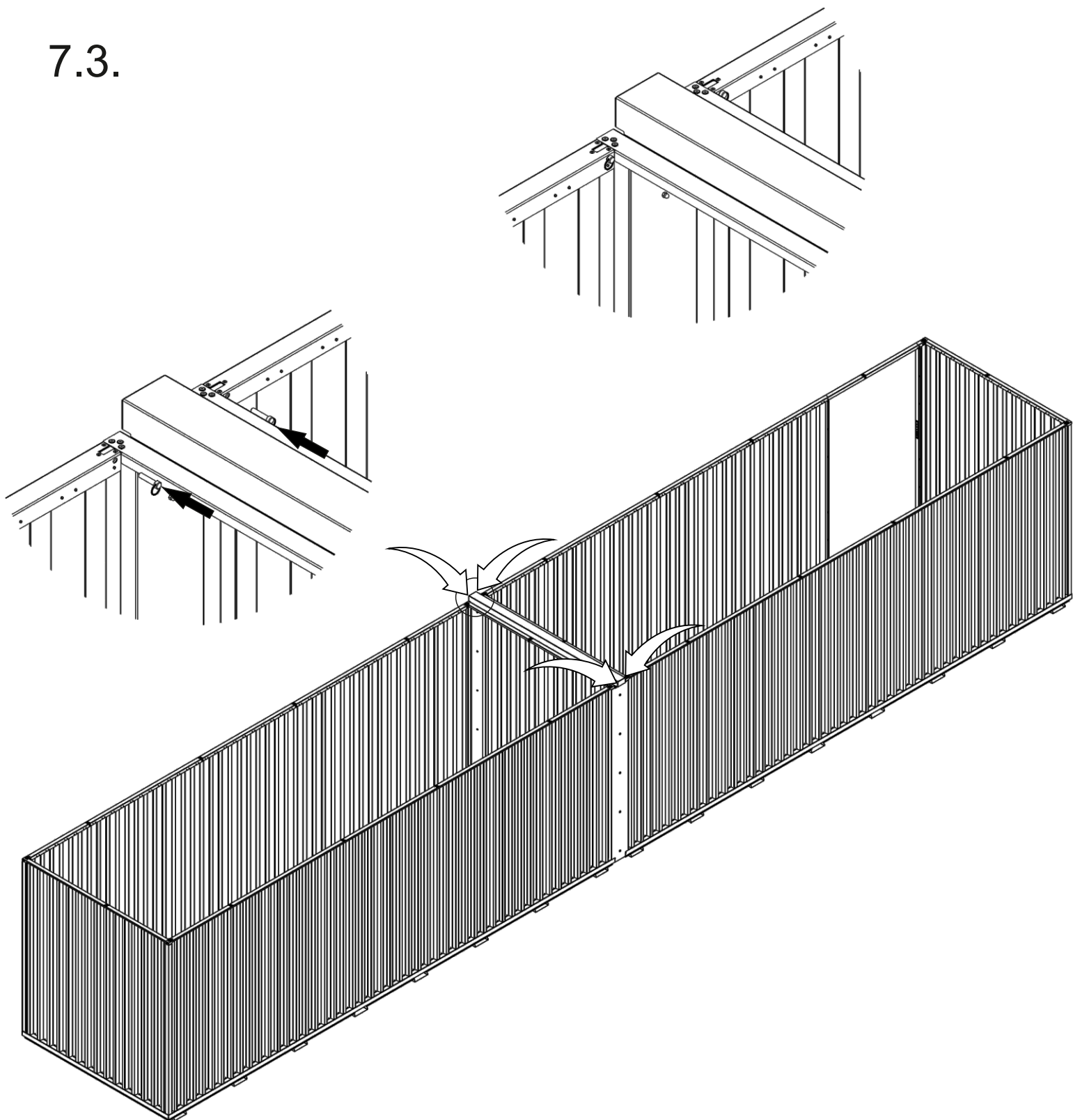



# 8.1.

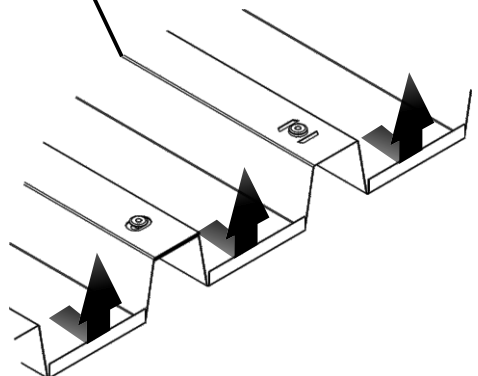
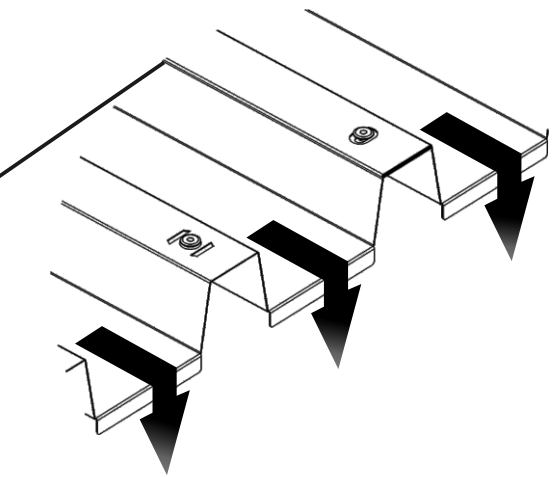
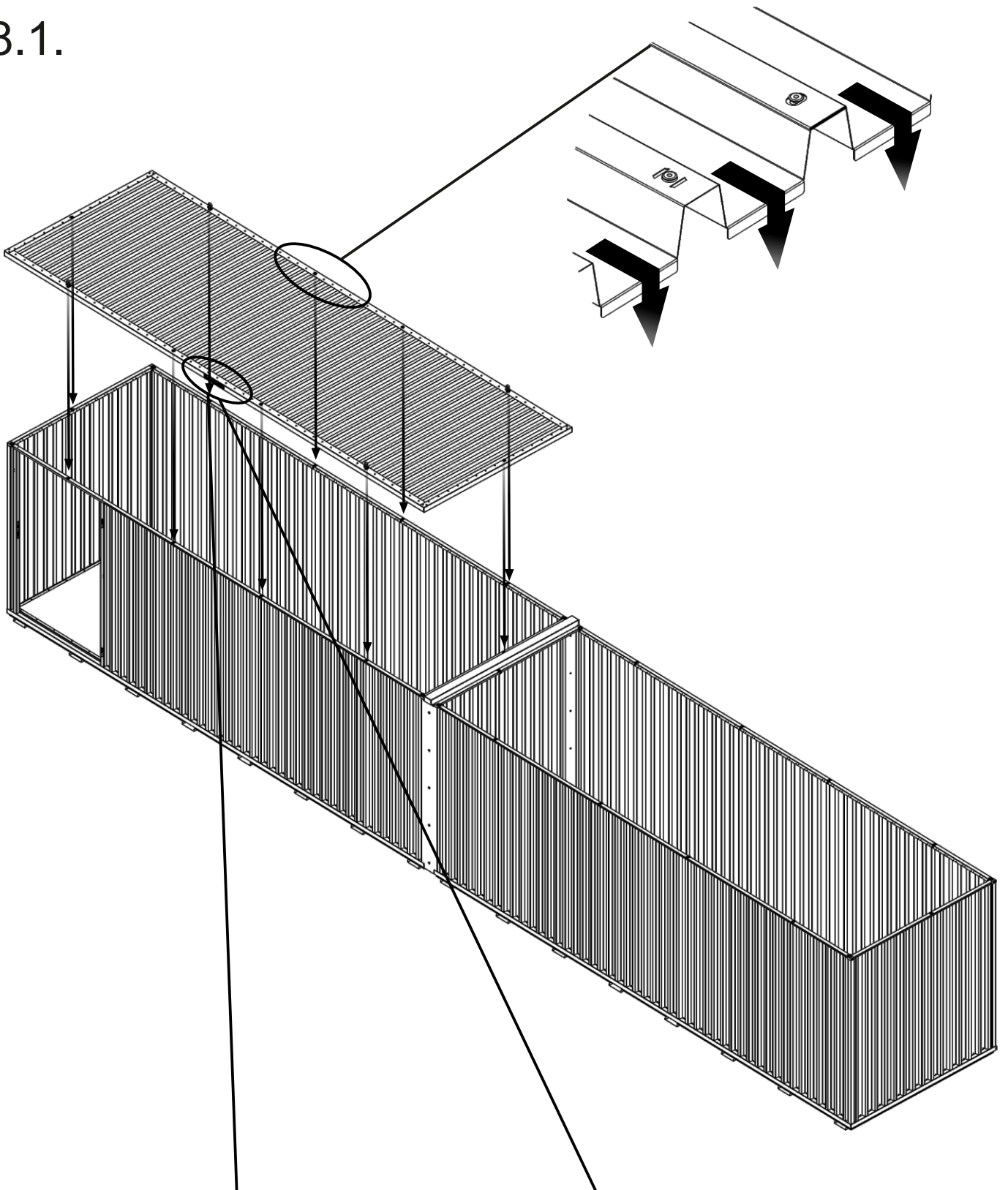

 Mass ...Kg.	 Total ... Kg.	 1640 MM	Model Code Production Tracking Code			
			 9001	 1401	 3001	

8.2.

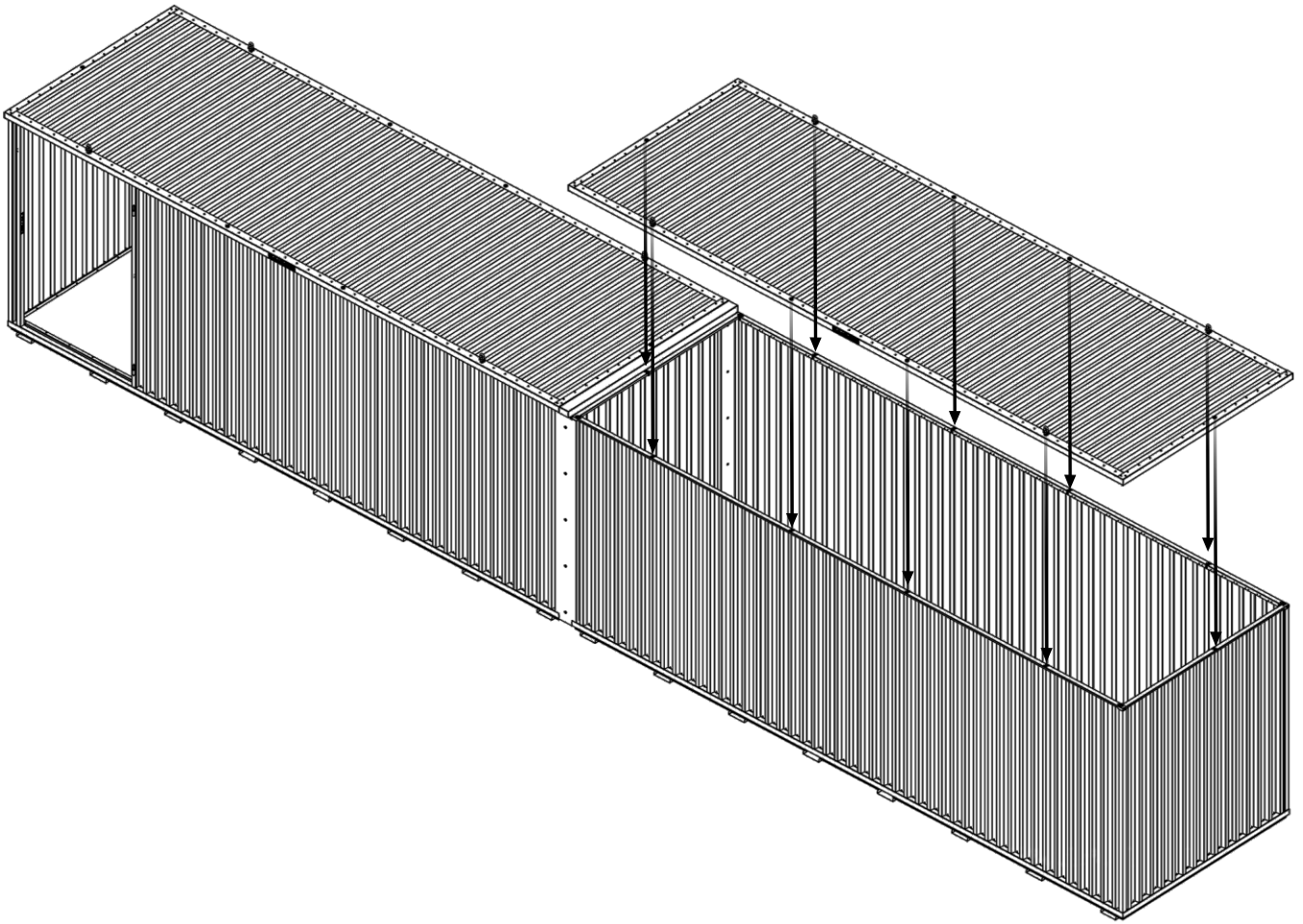

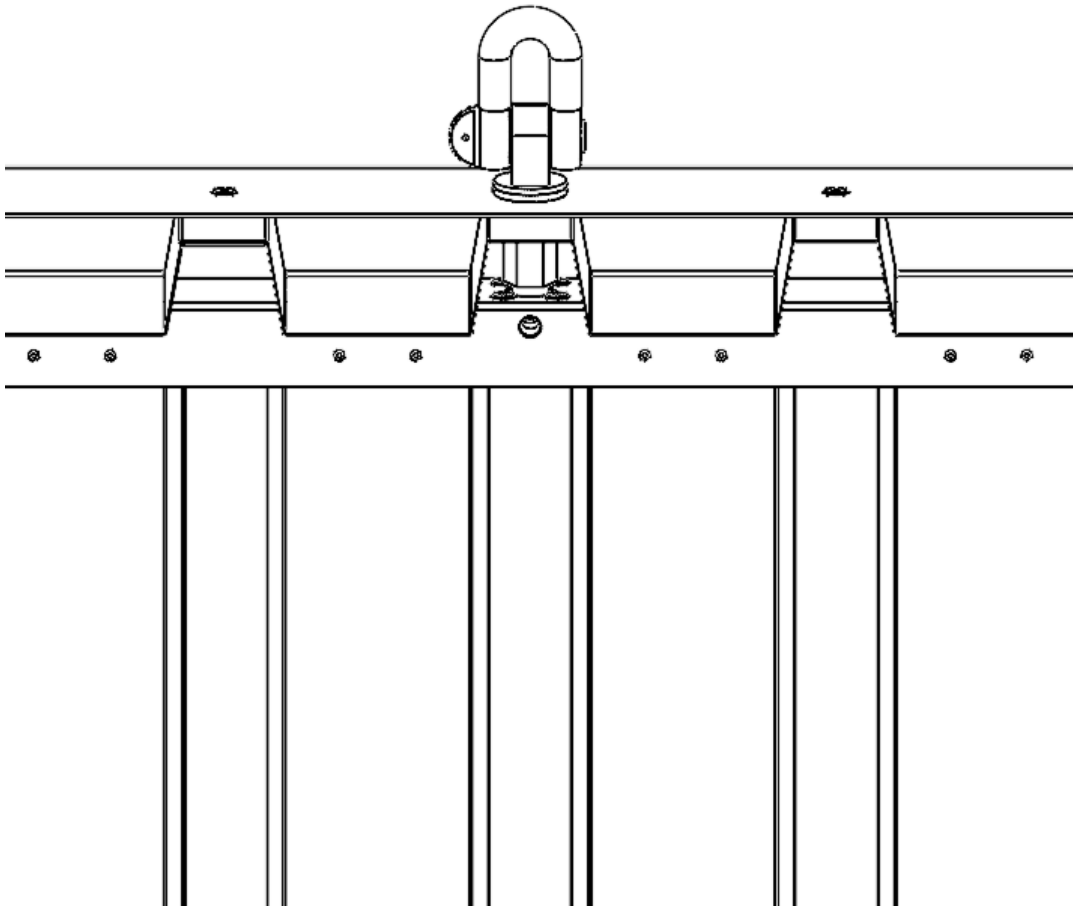
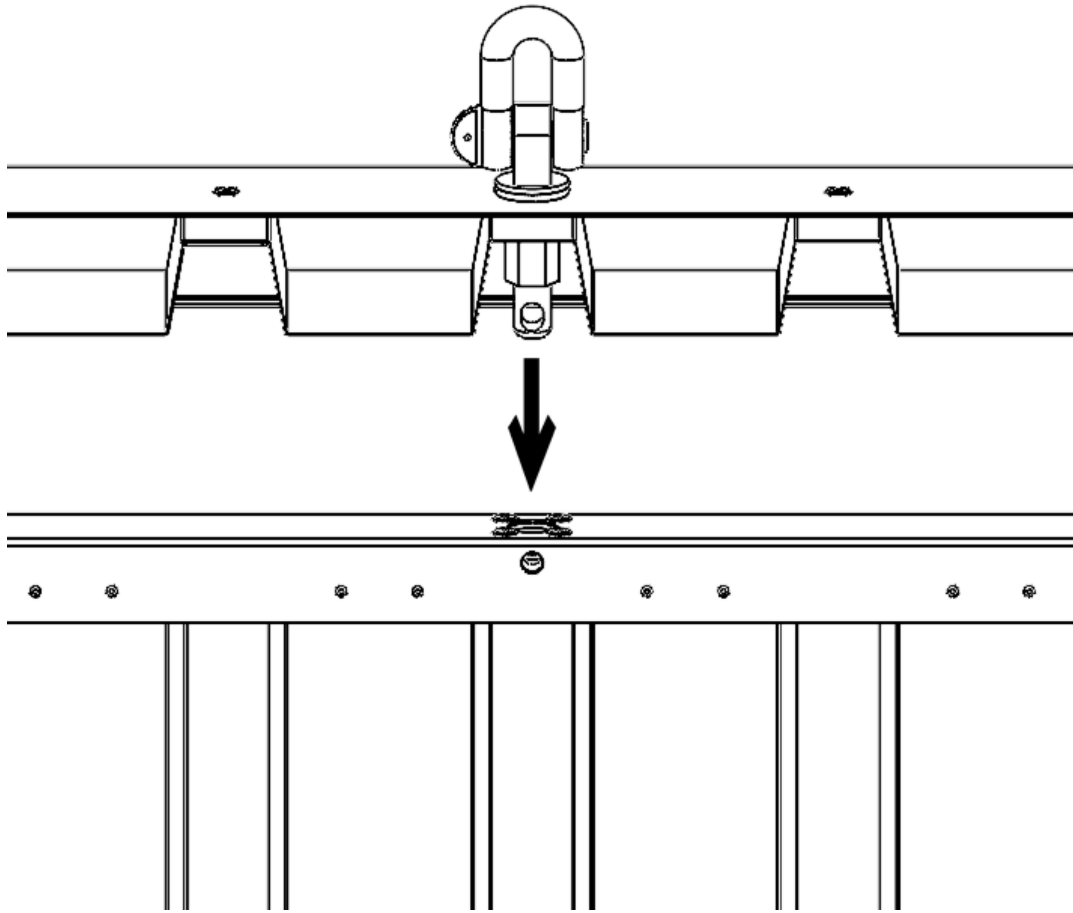

8.3.

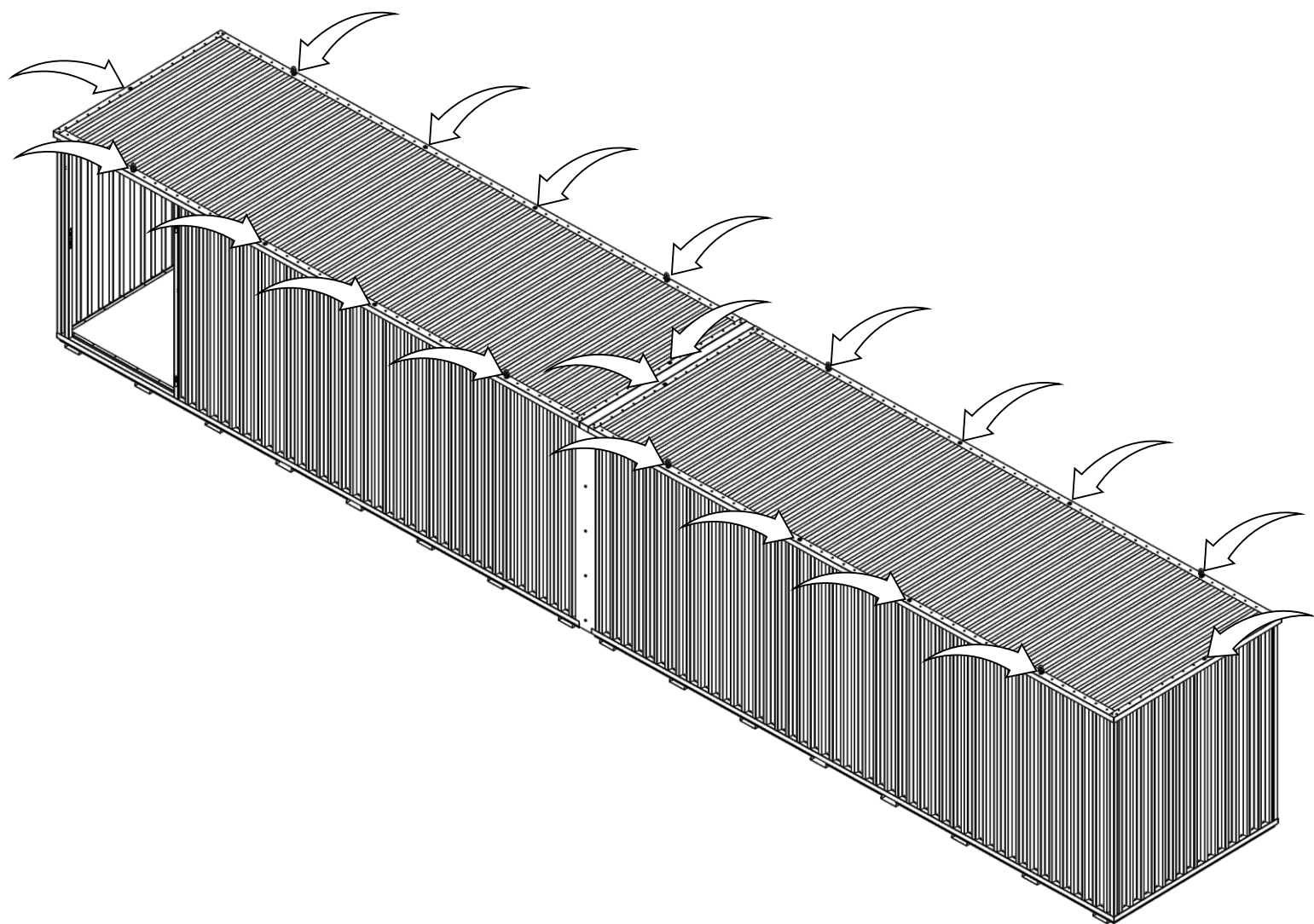

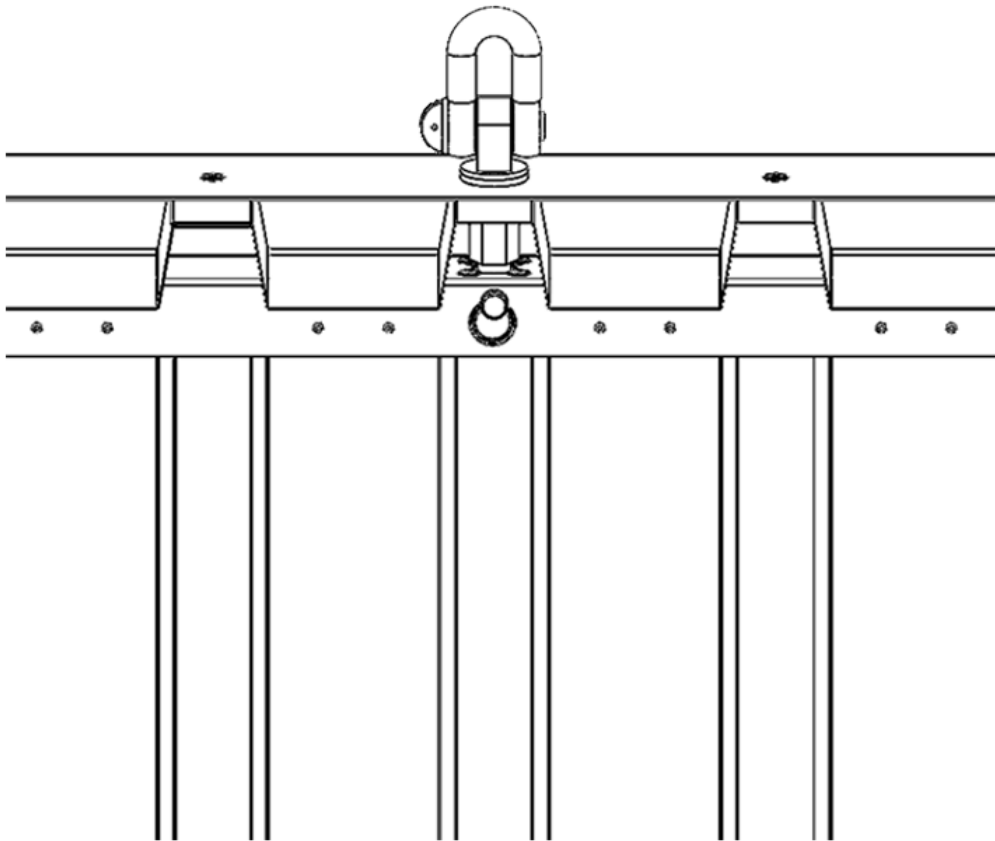
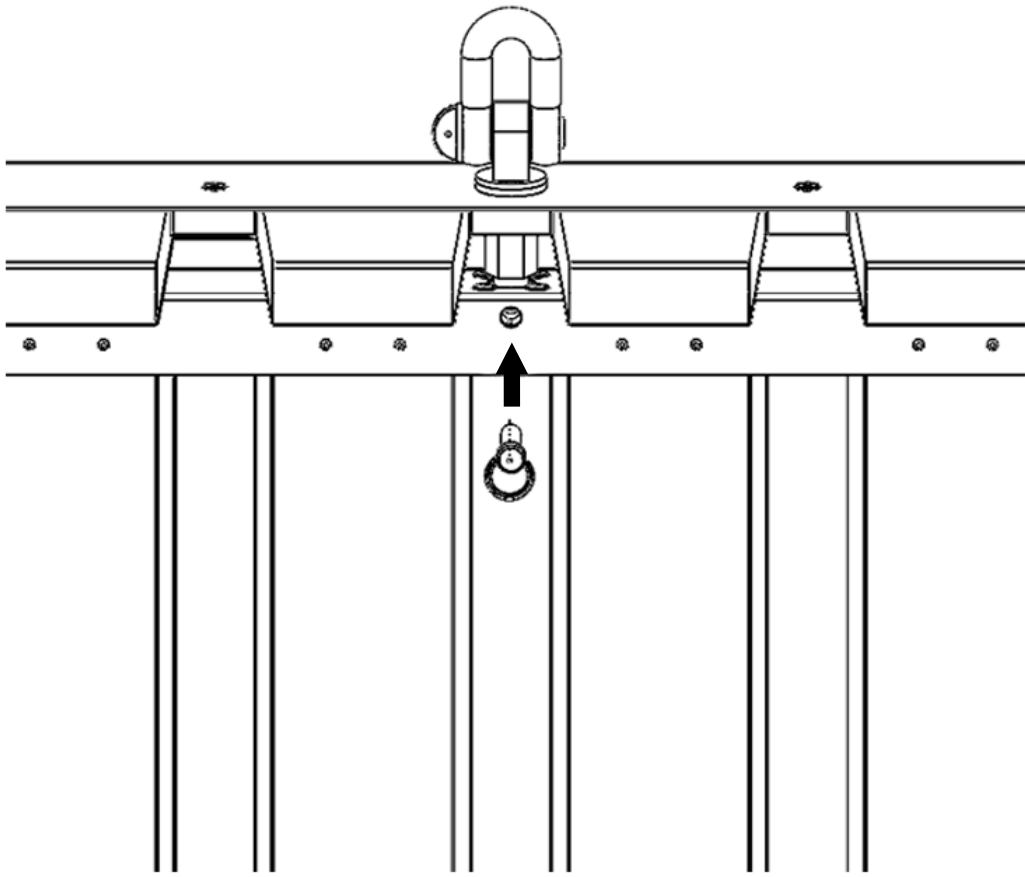

9.1.

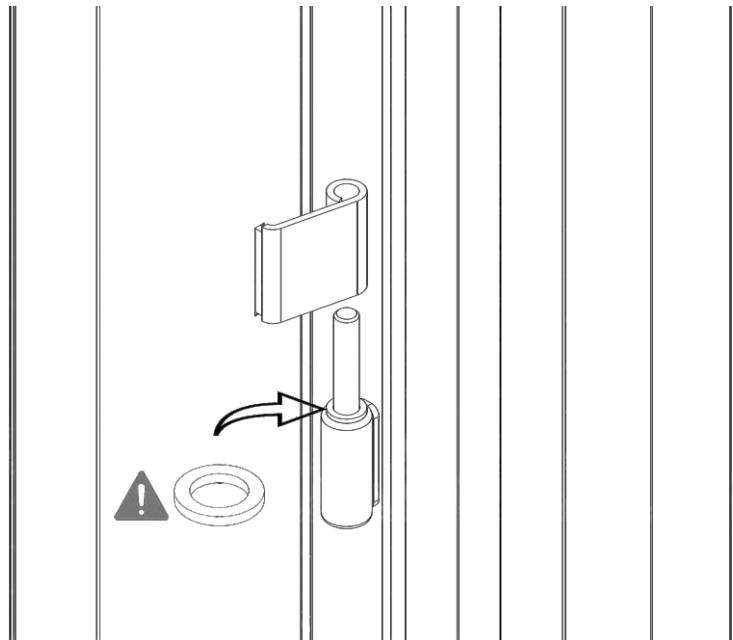
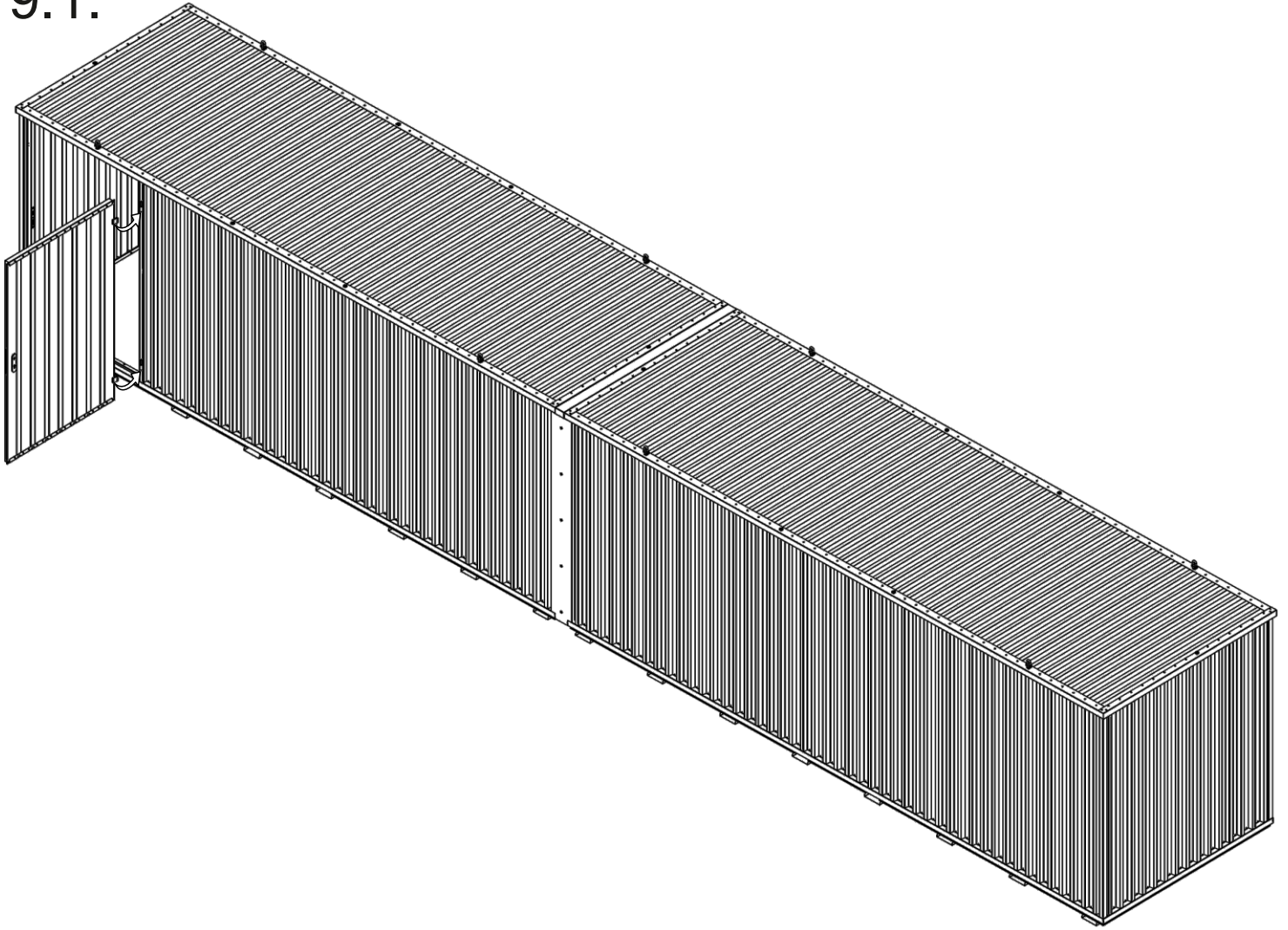

9.2.

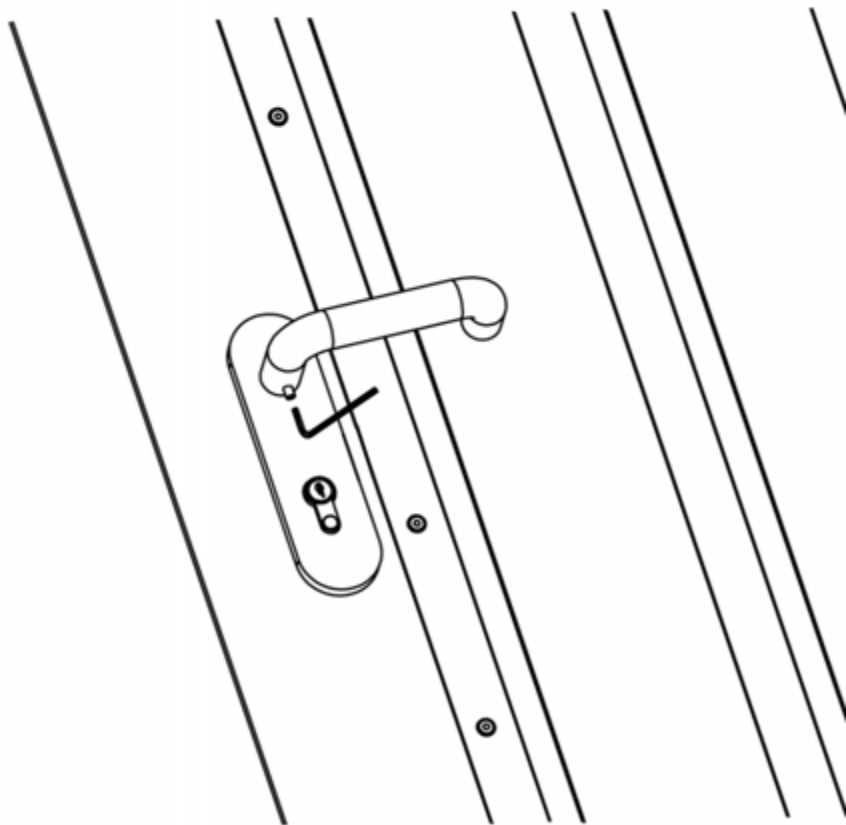
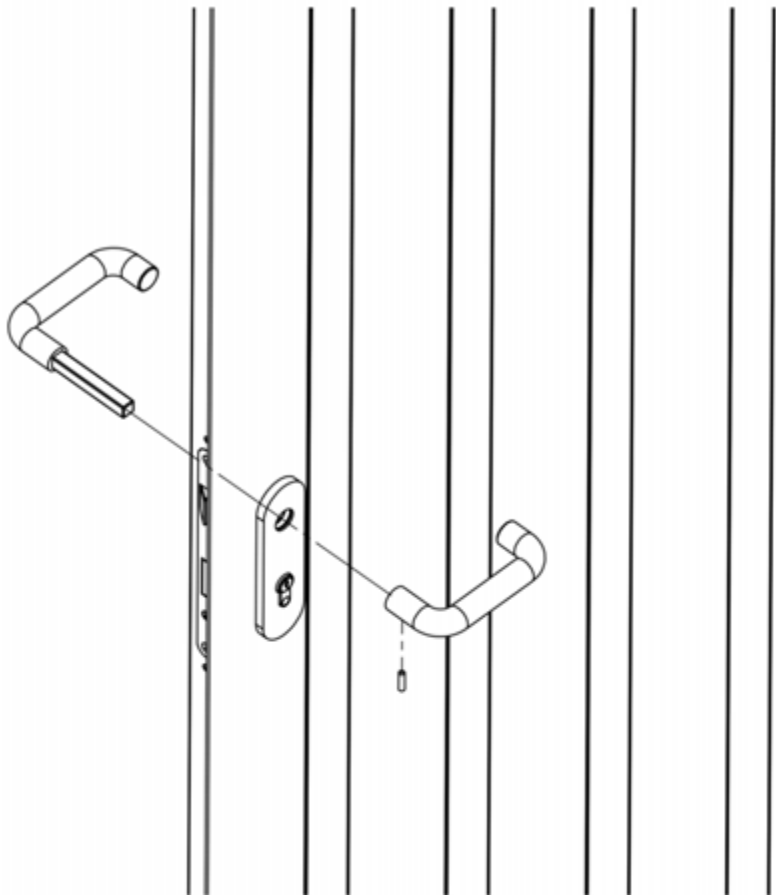

10.1.

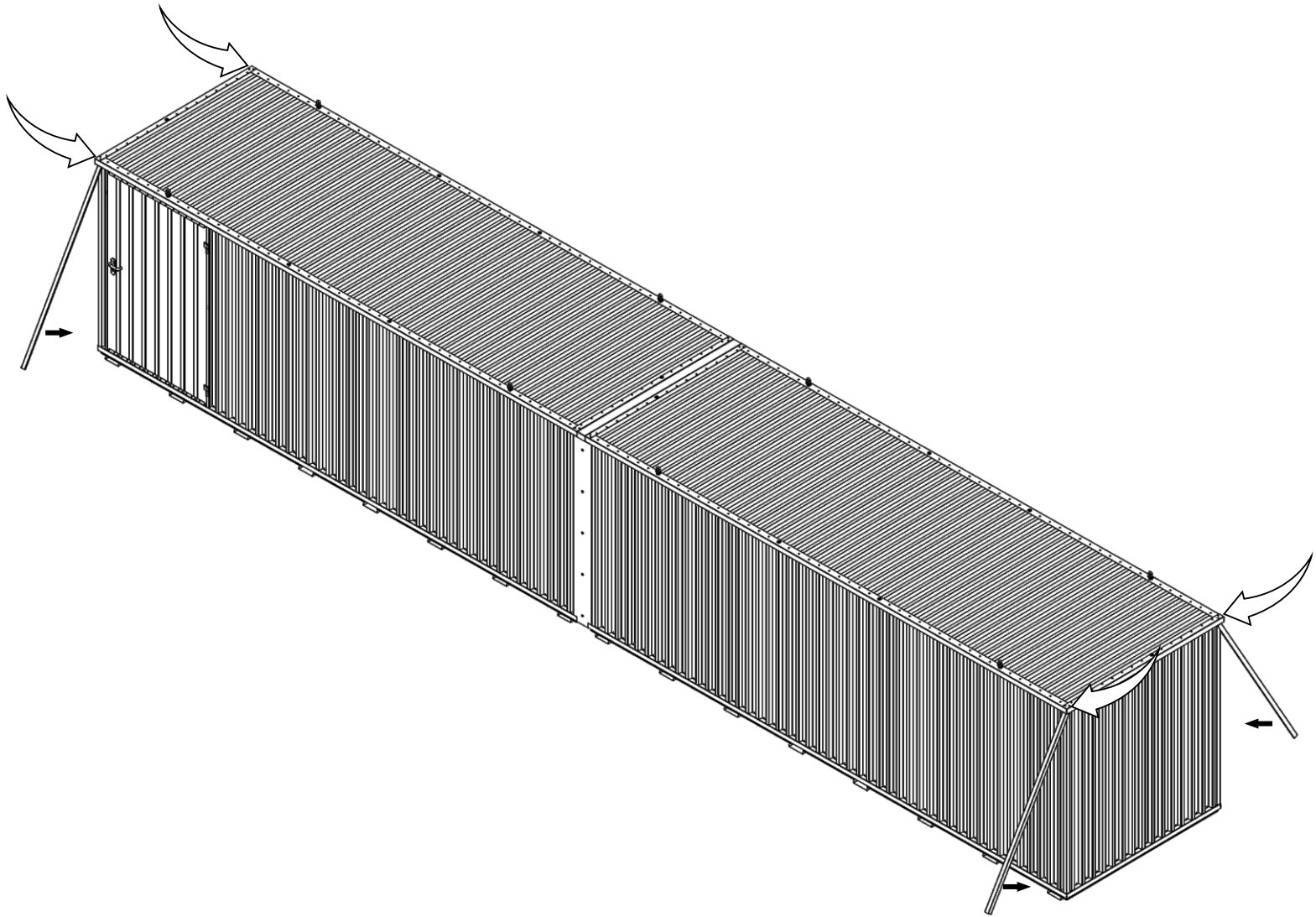



11.1.

