

PRODUCT CODE:5040.110.450.320

prefabase
Quick Build Solutions

Instructions and User Guide

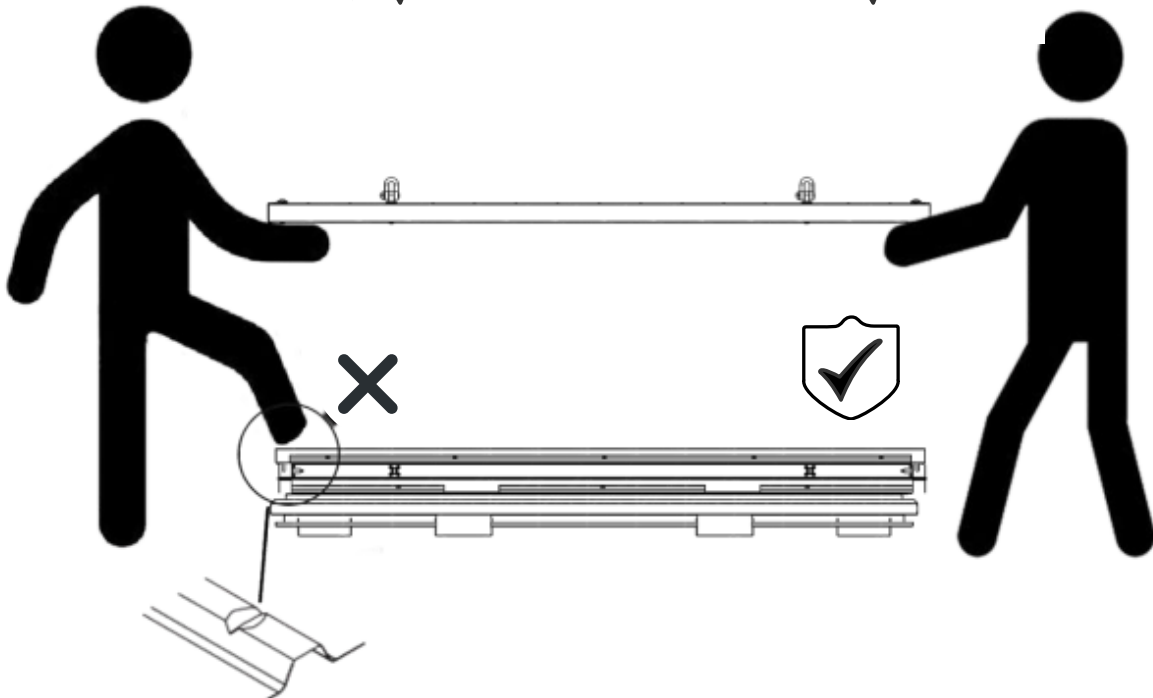
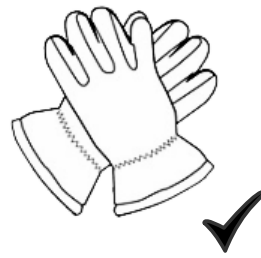
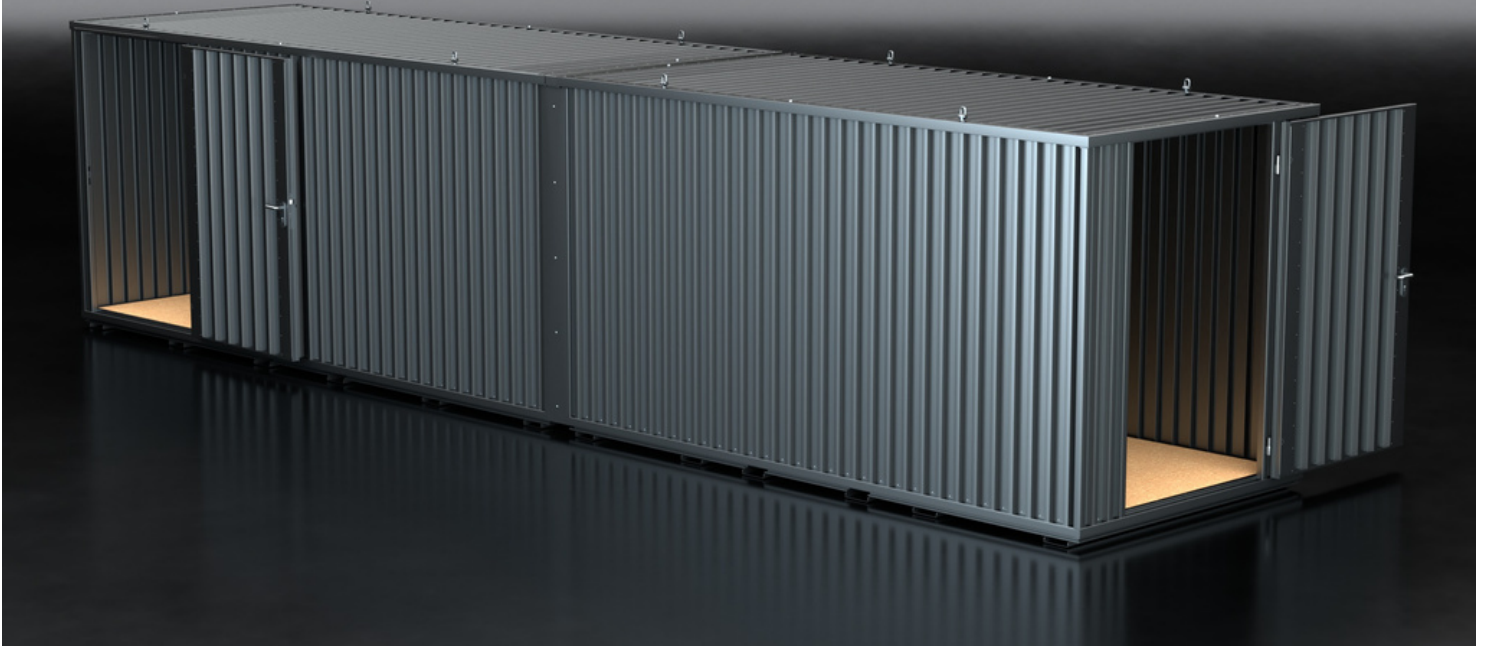

50.0110
1x

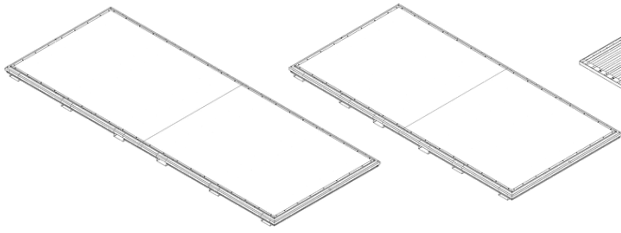

40.0110
1x

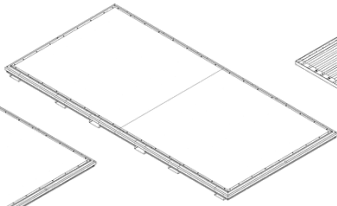

50.0510
1x

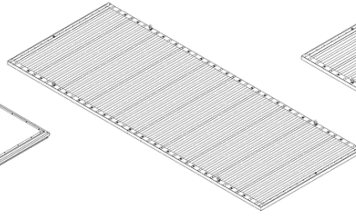

40.0510
1x

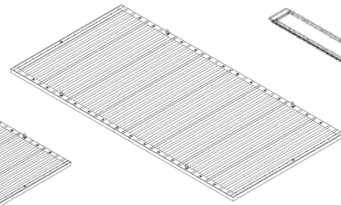

306.0110
1x



306.0510
1x



50.0410
2x

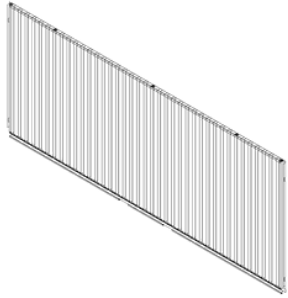

40.0410
1x

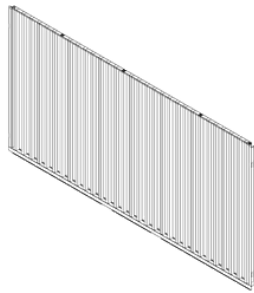

40.0450
1x

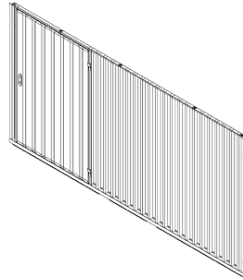

0310
1x

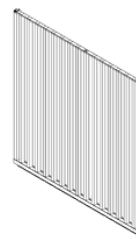

0320
1x



306.40.05
2x



306.40.04
2x



61.101
4x



24x



2x

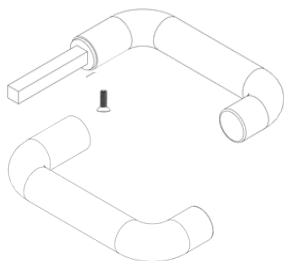

10x



10x



10x



1x



2x



1

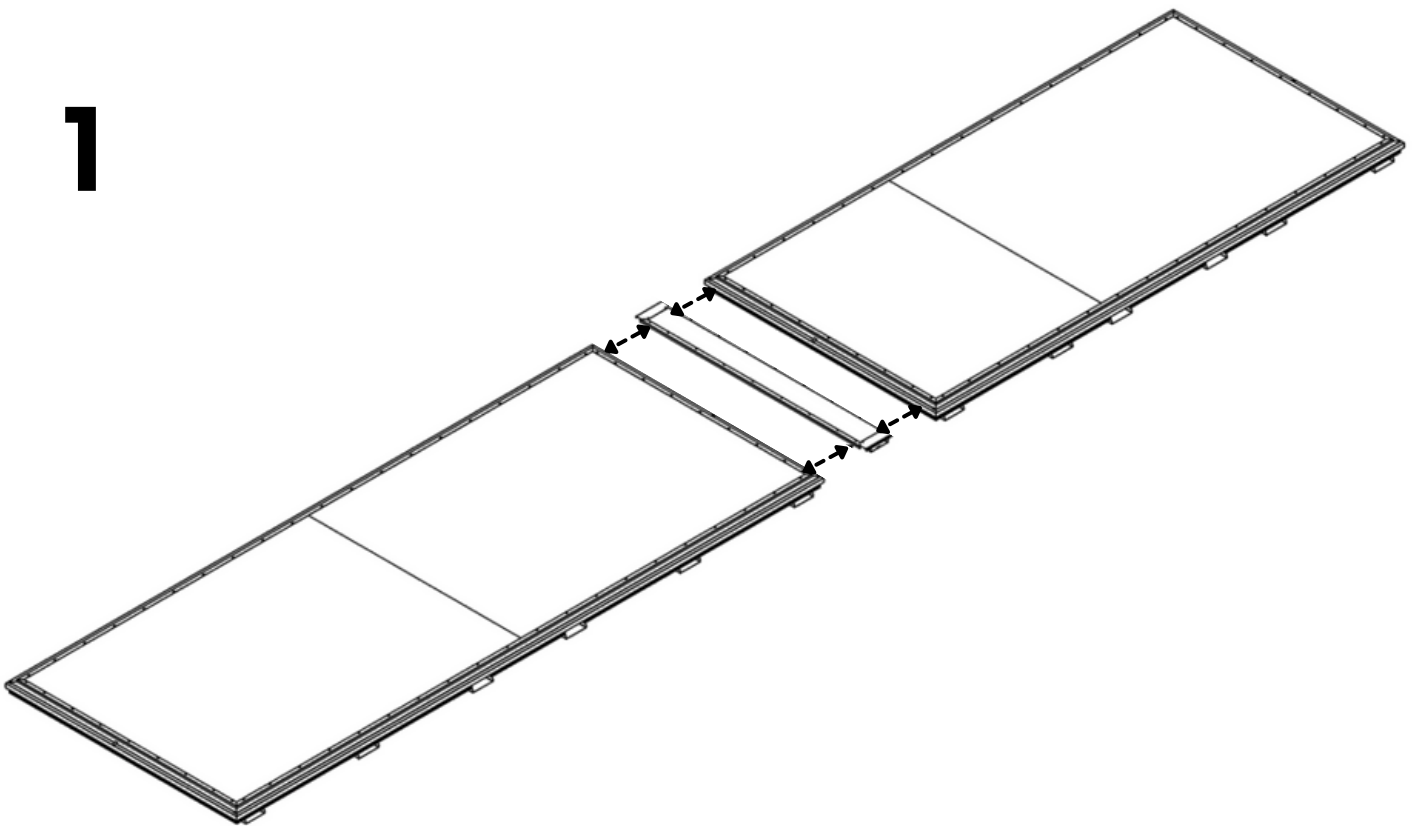

2

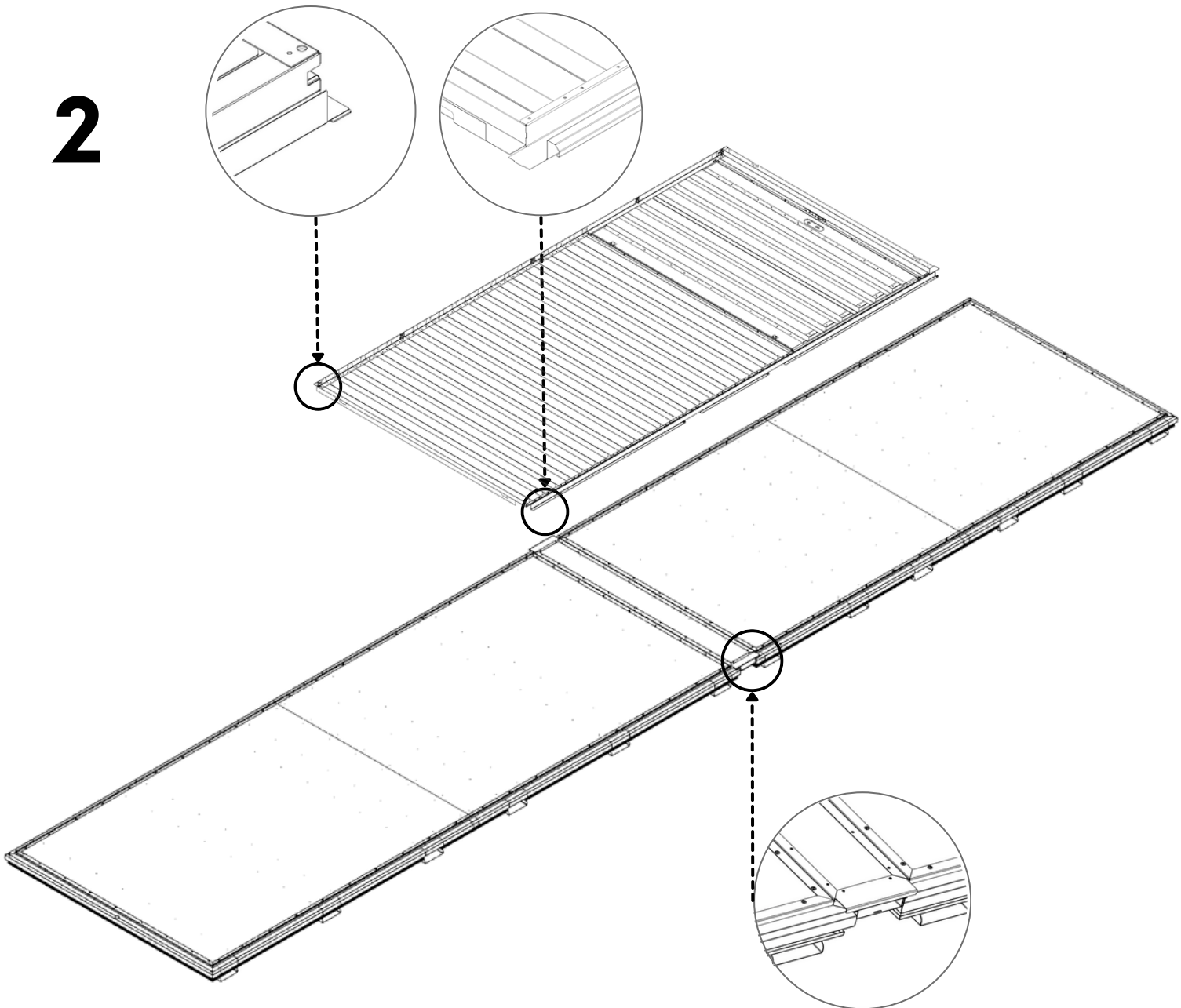

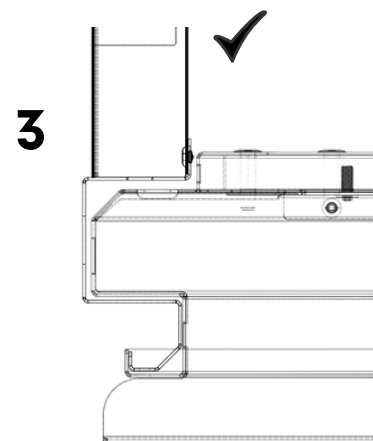
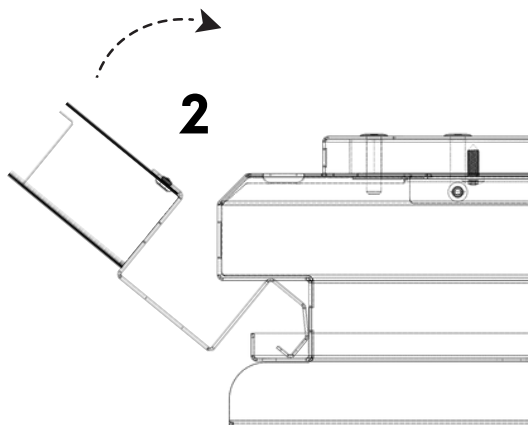
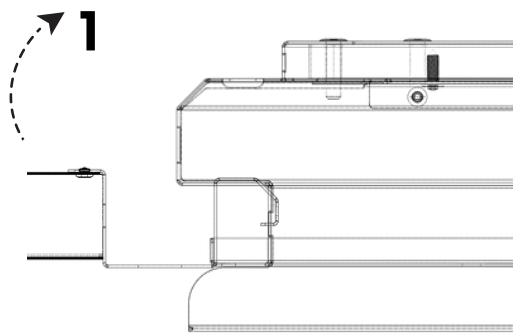

3

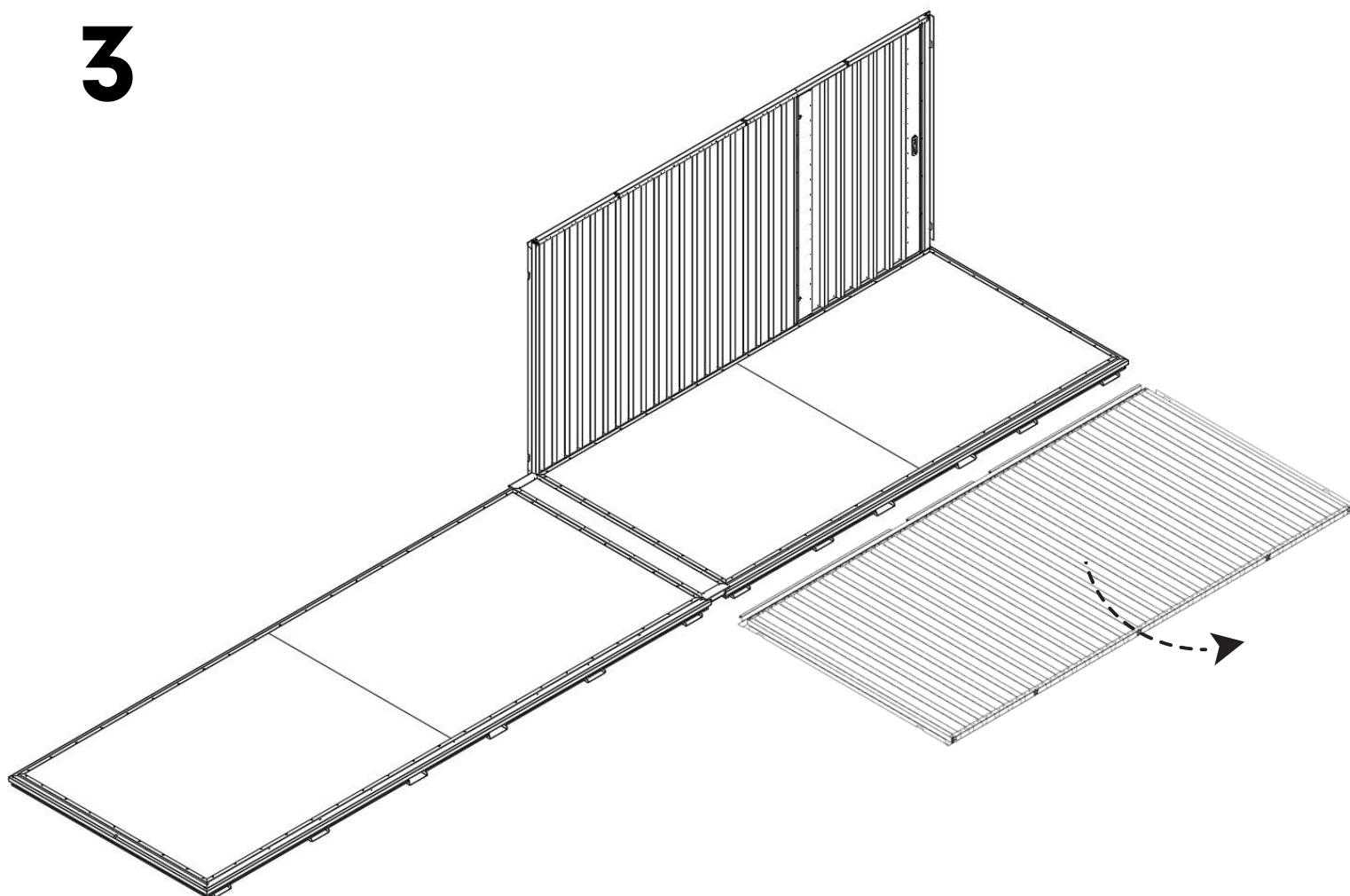

4

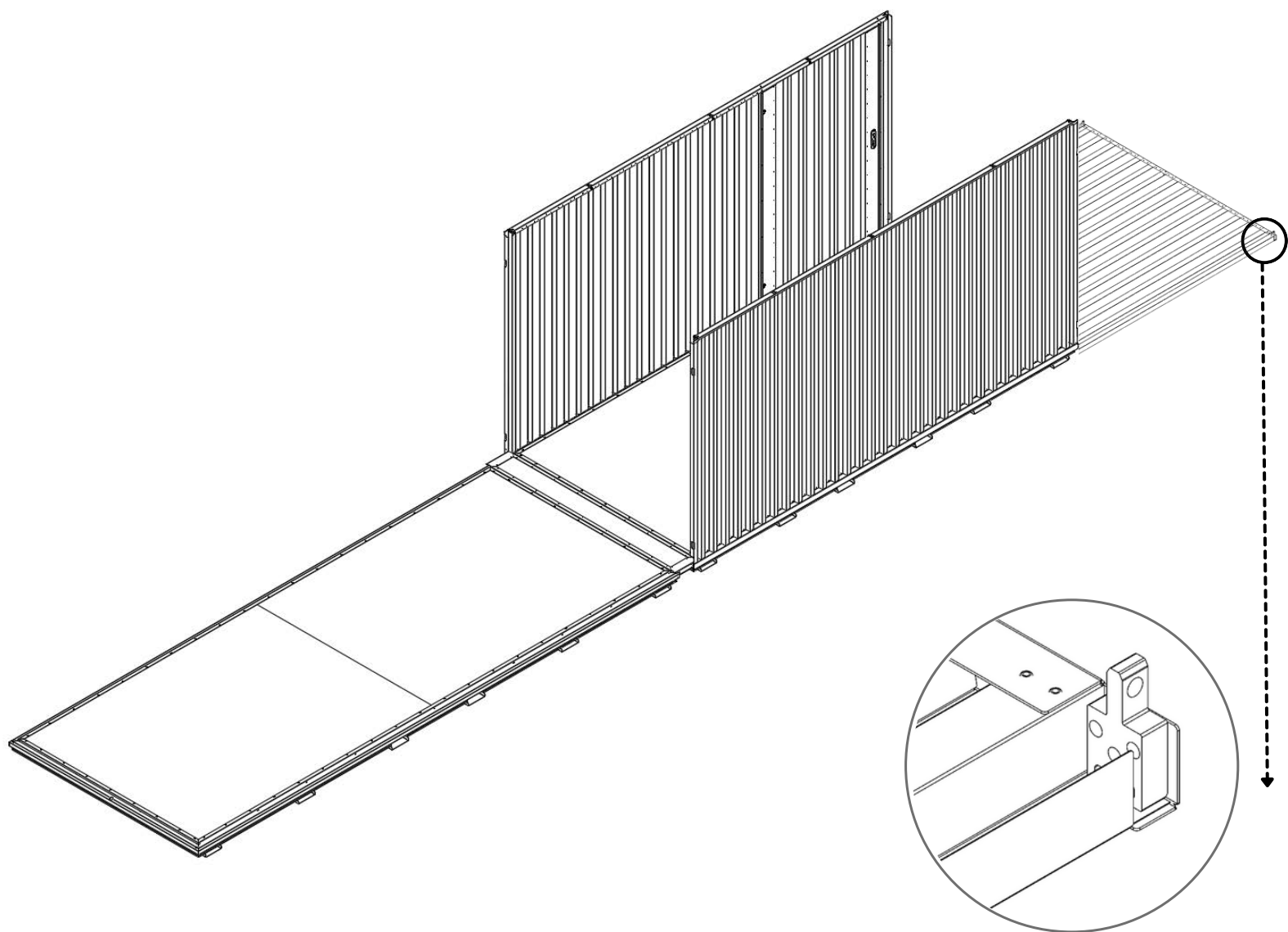

4.1

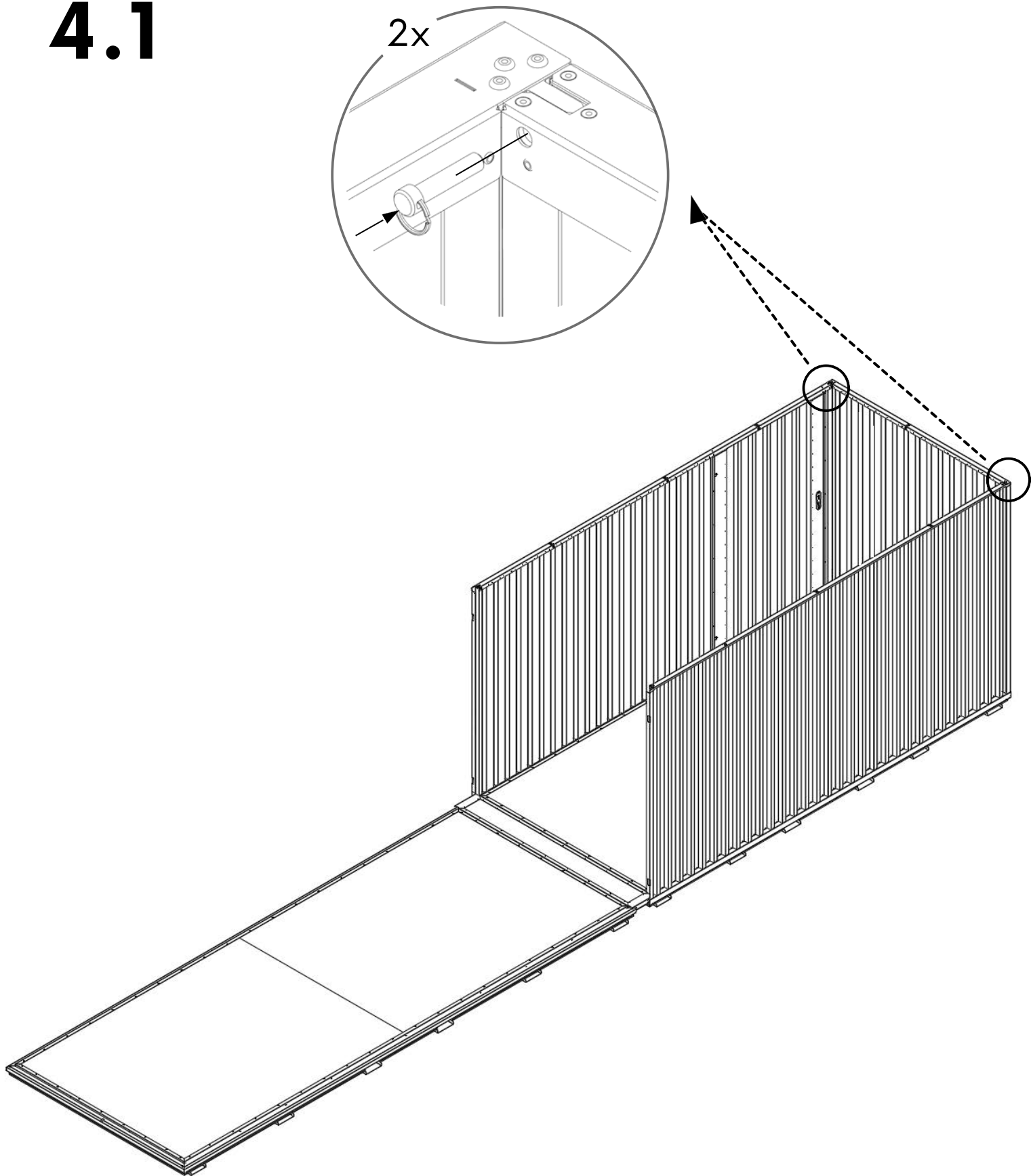

5

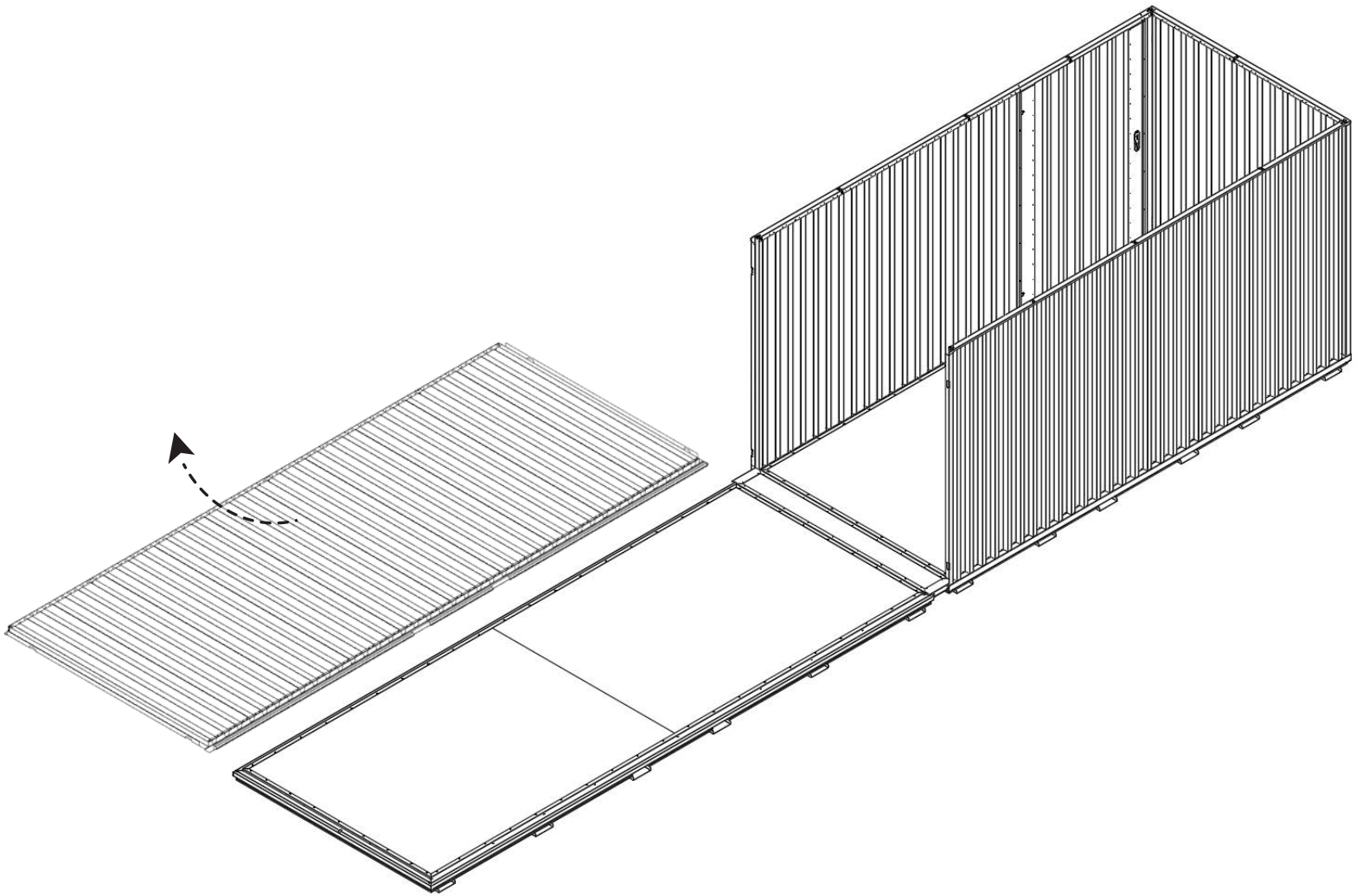

6

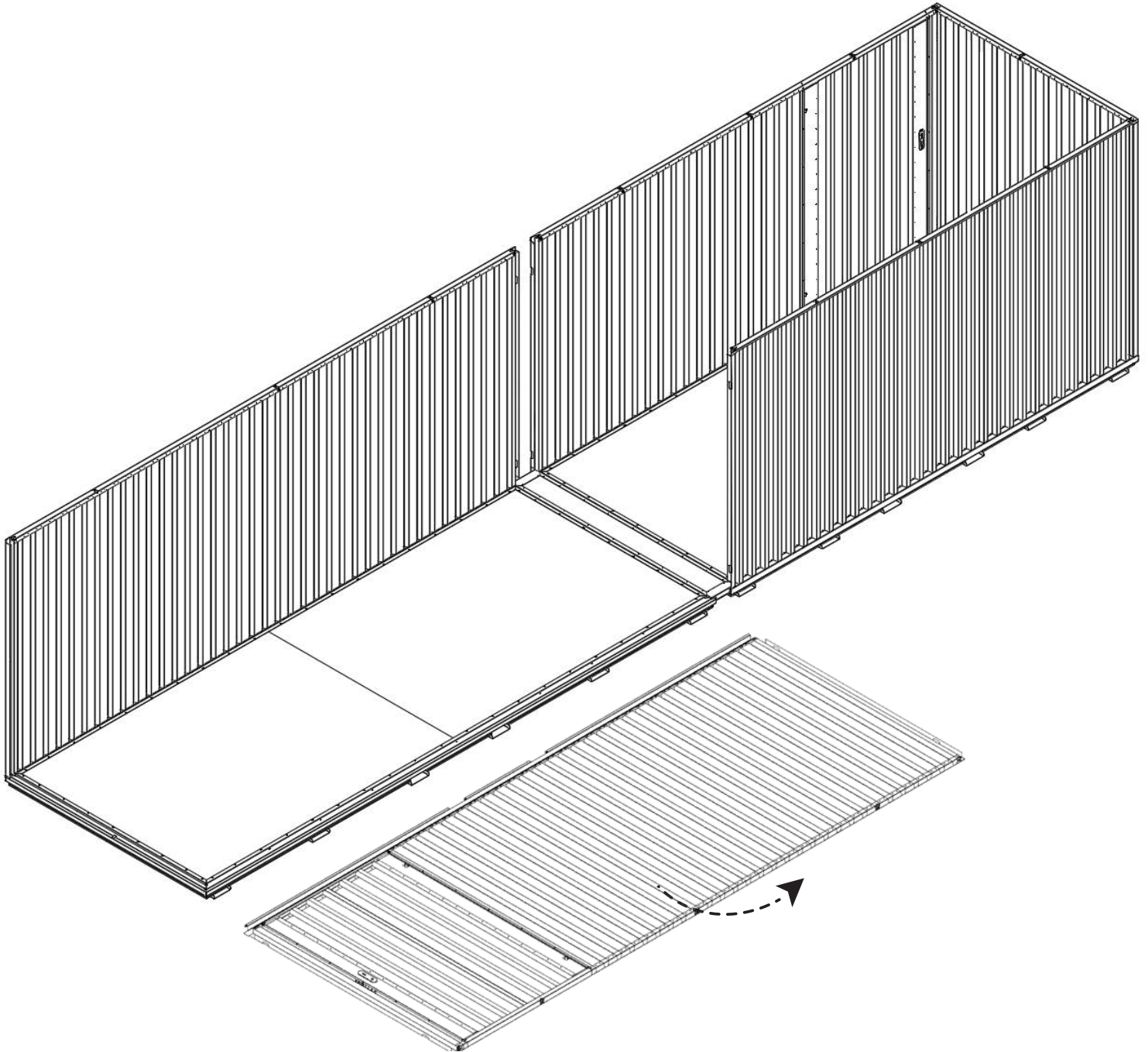

7

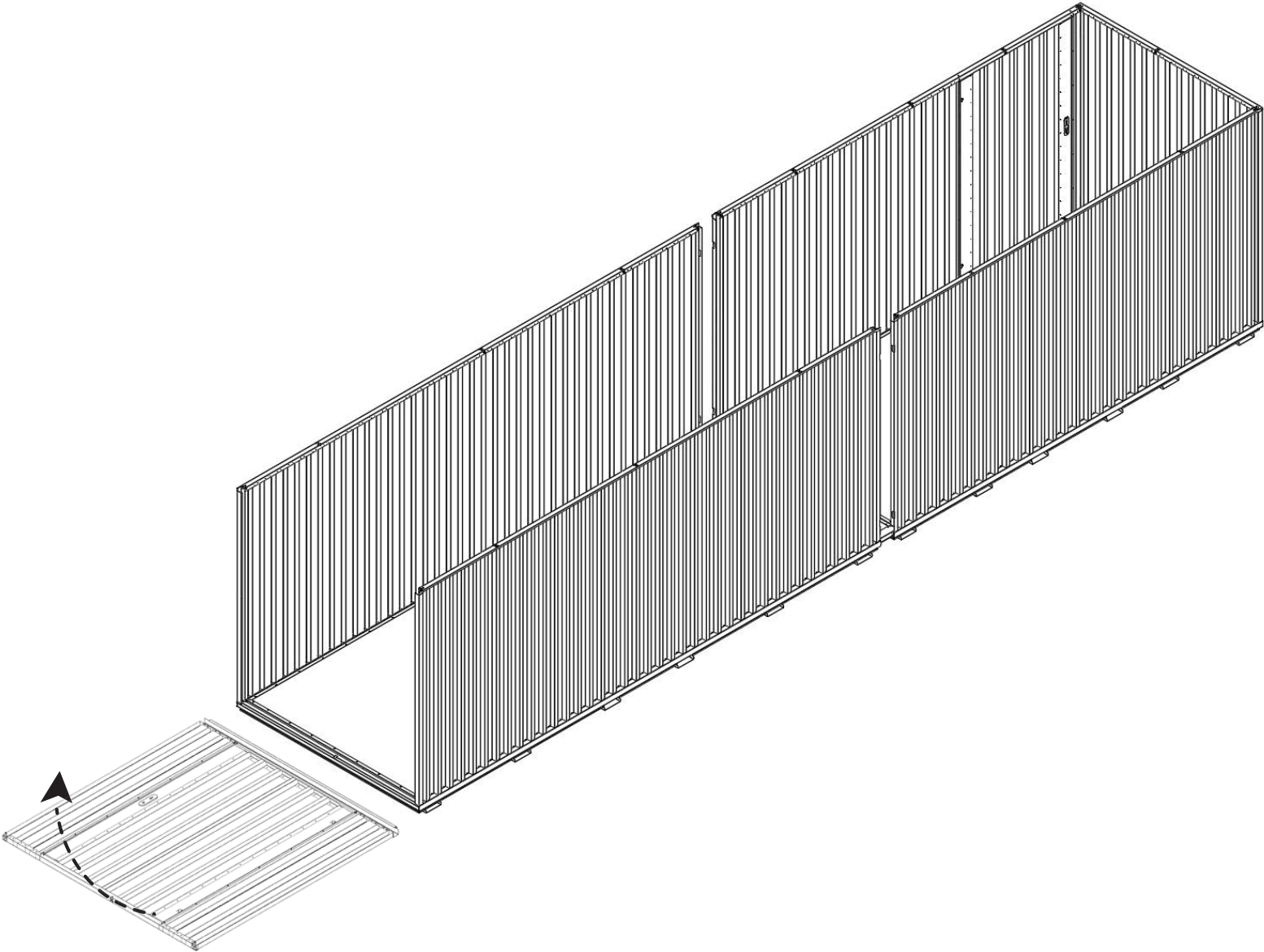

7.1

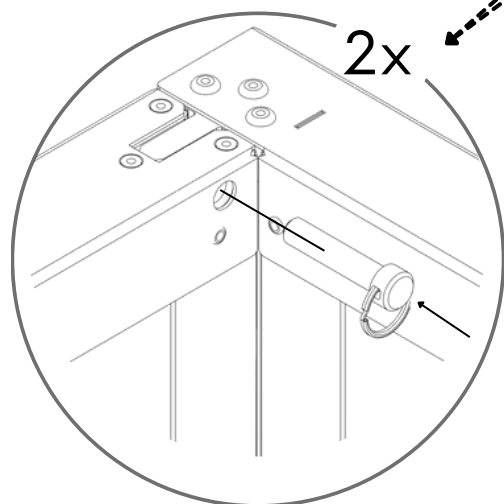
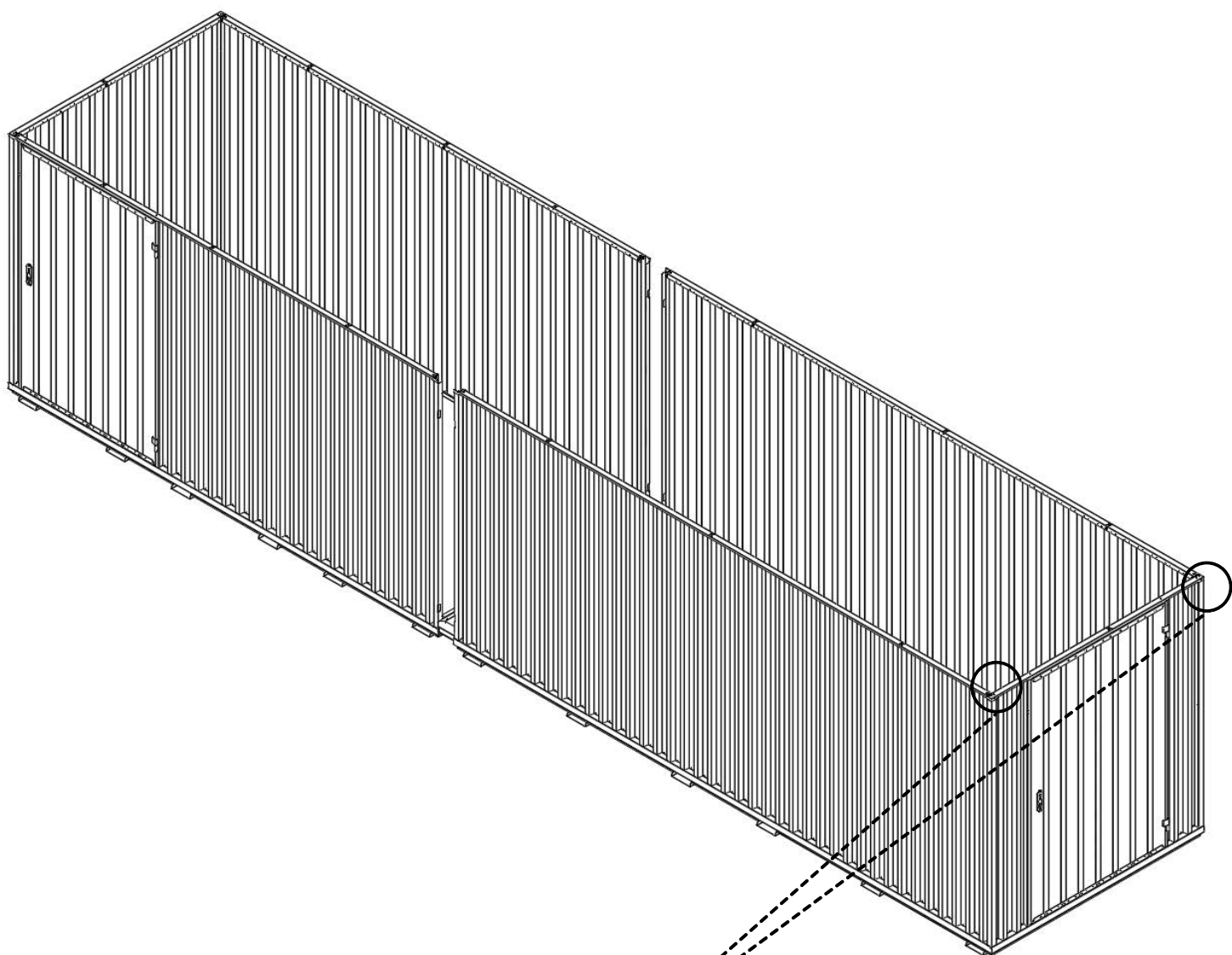

8

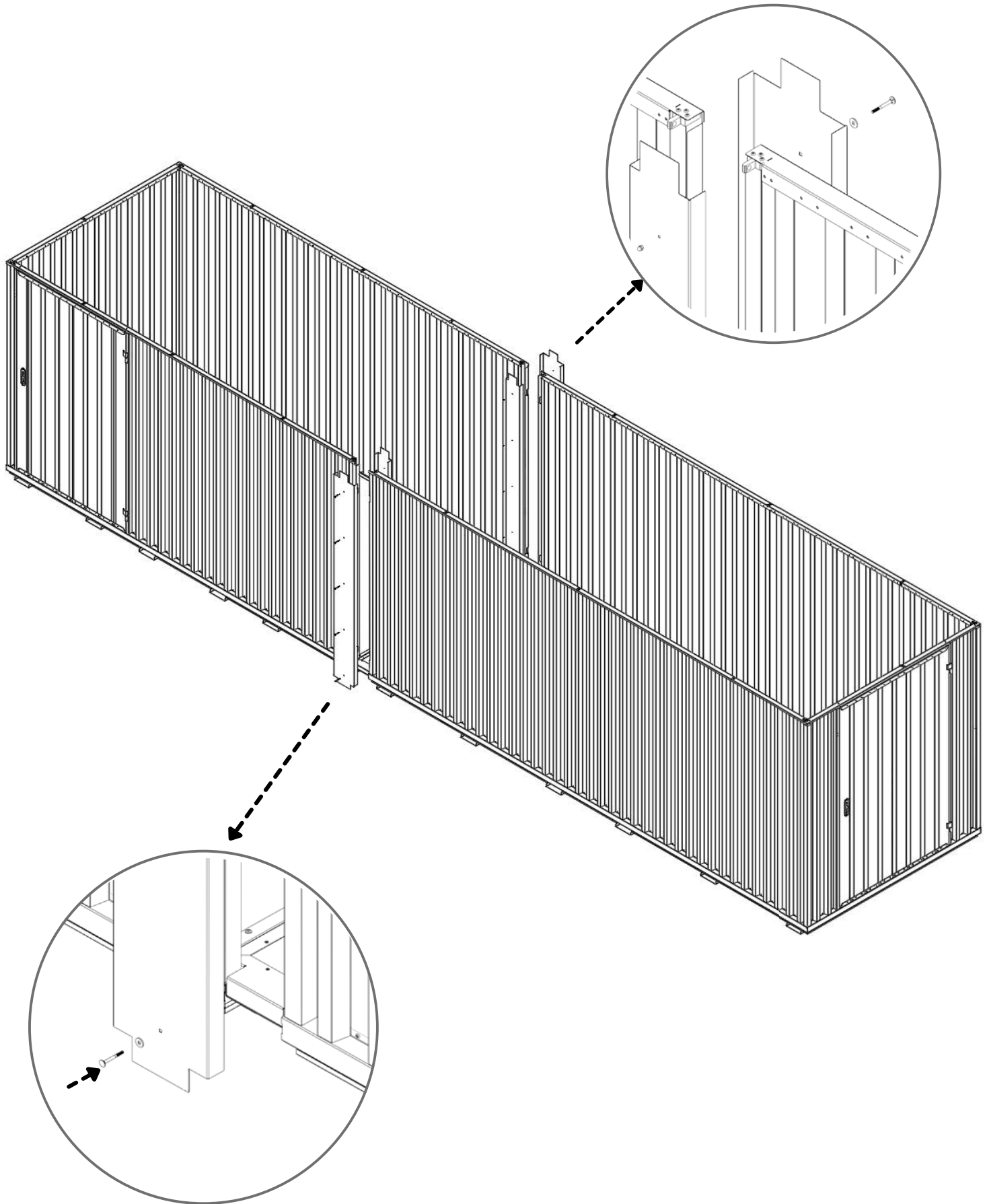

9

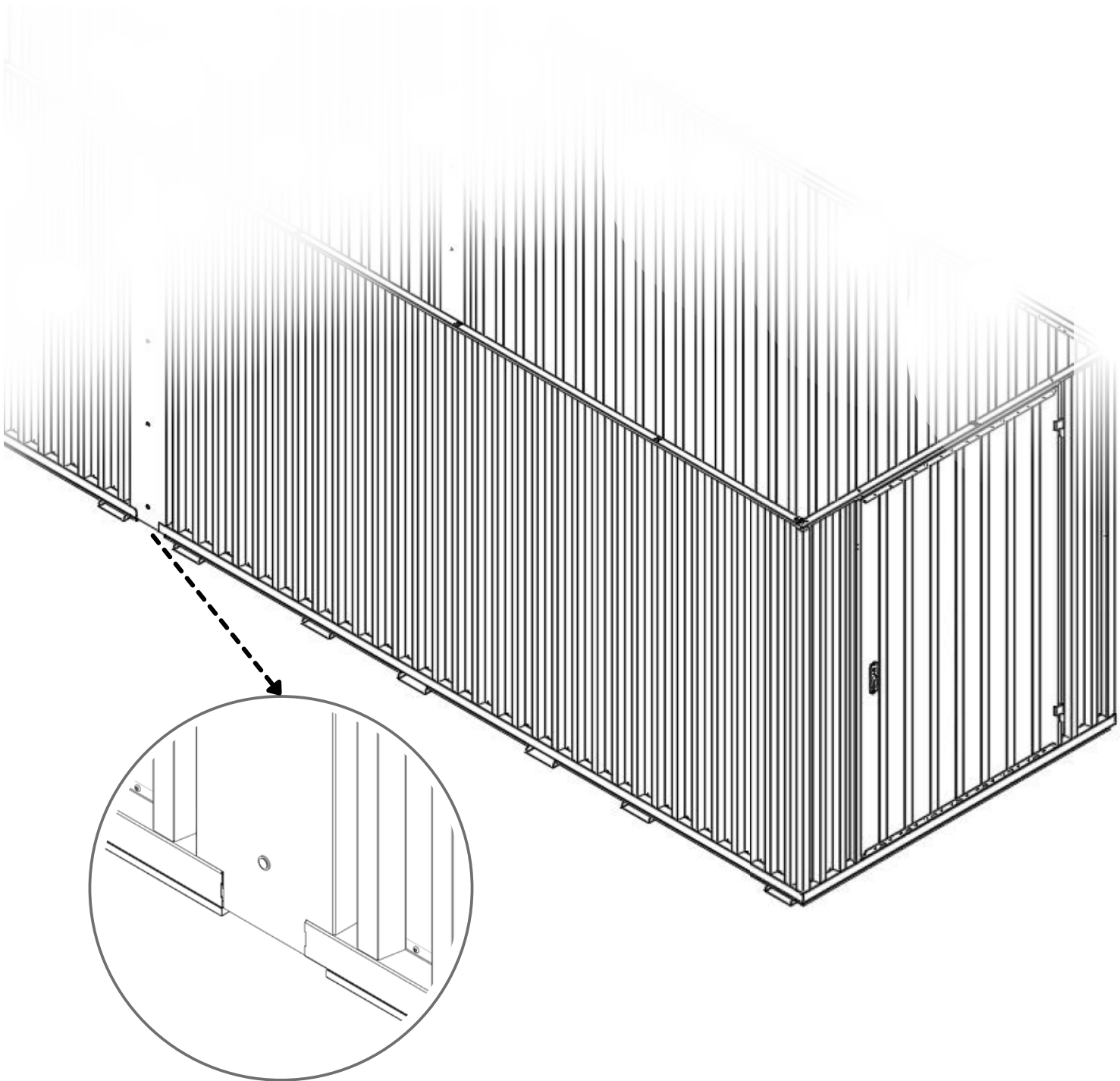



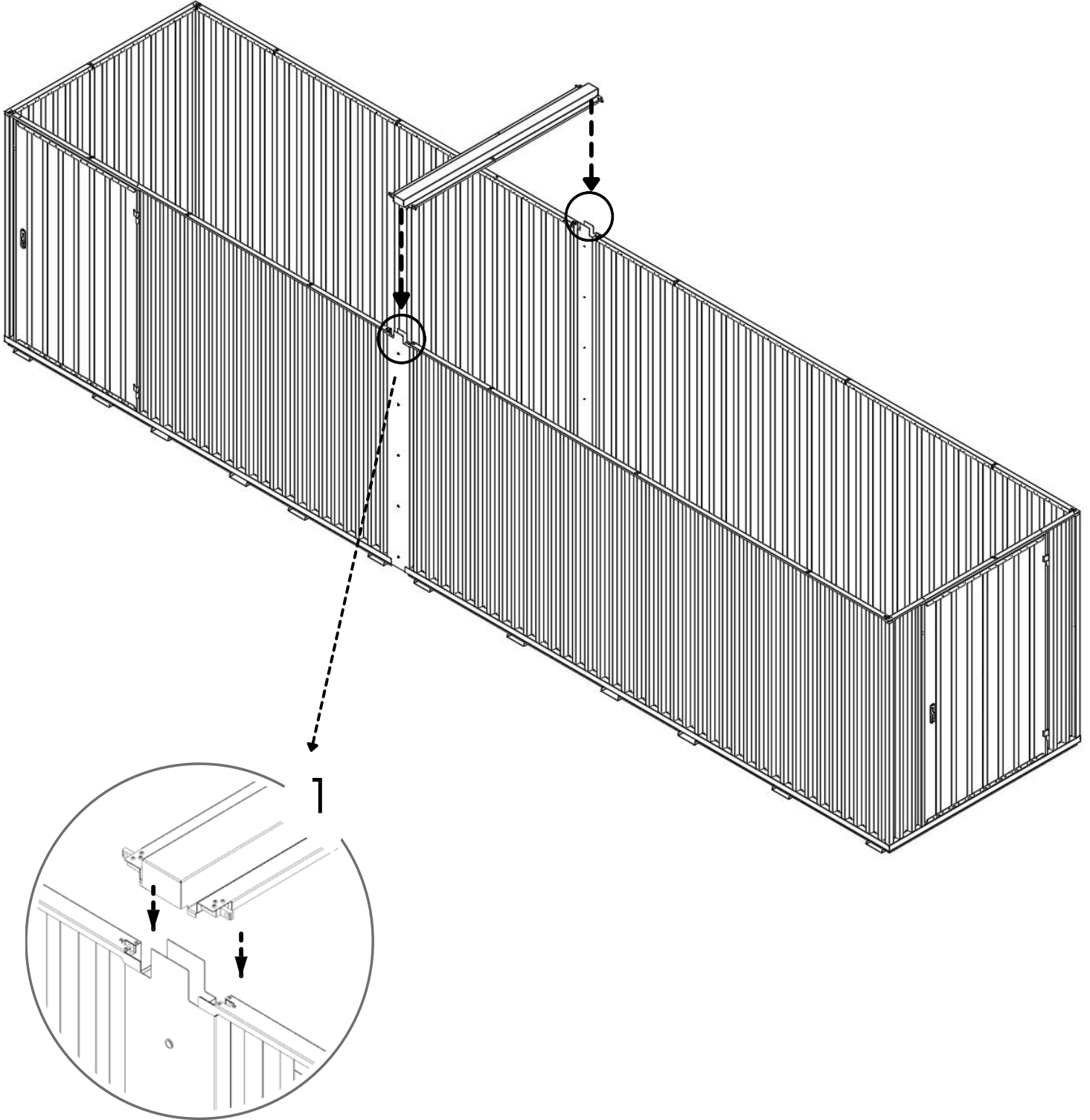



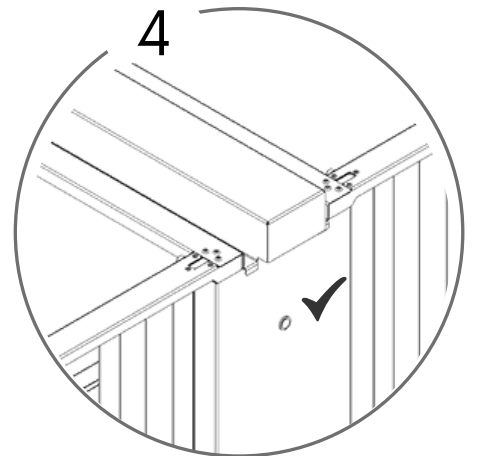
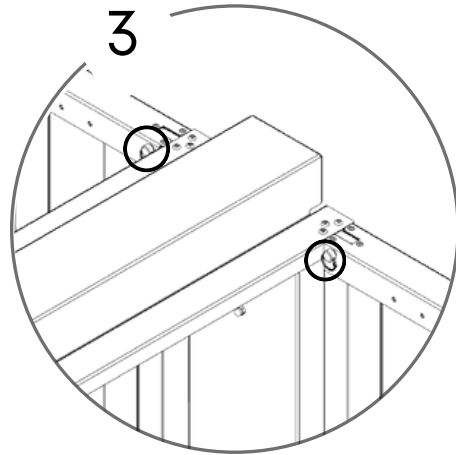
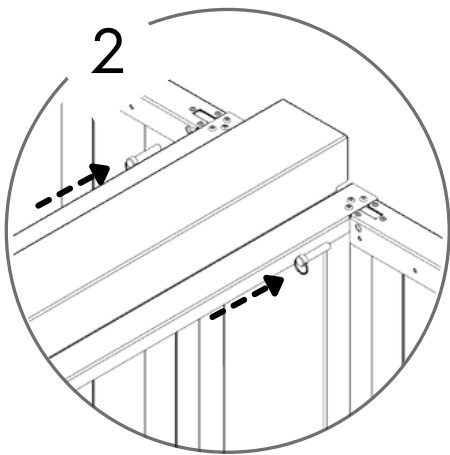
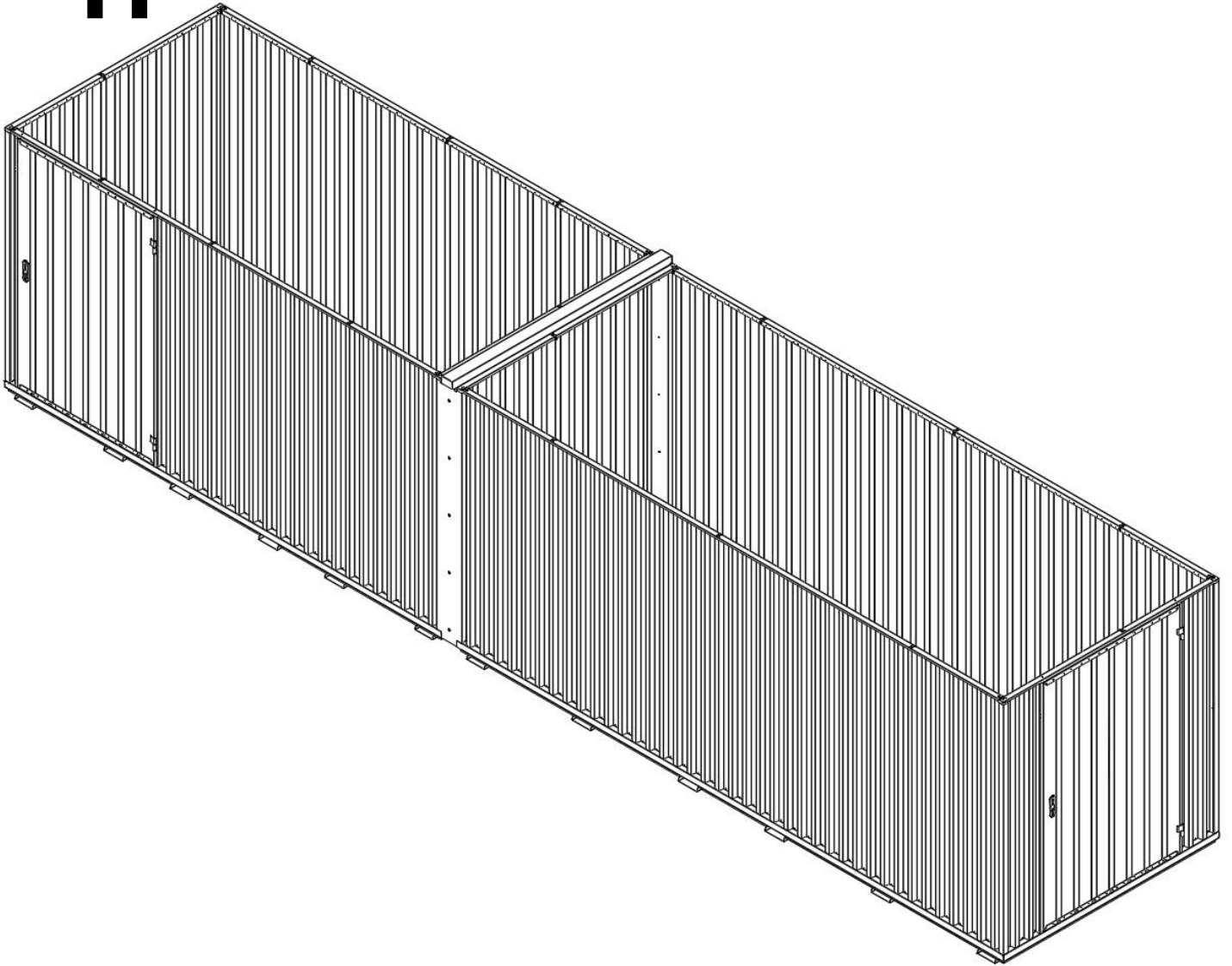

10



11





 885 KG	 1640 MM	Model Code: 5040.110.450.320 Production Tracking Code:/X09.1.5040.450.320	 9001	 14001	 50001			
---	--	---	---	--	--	---	---	---

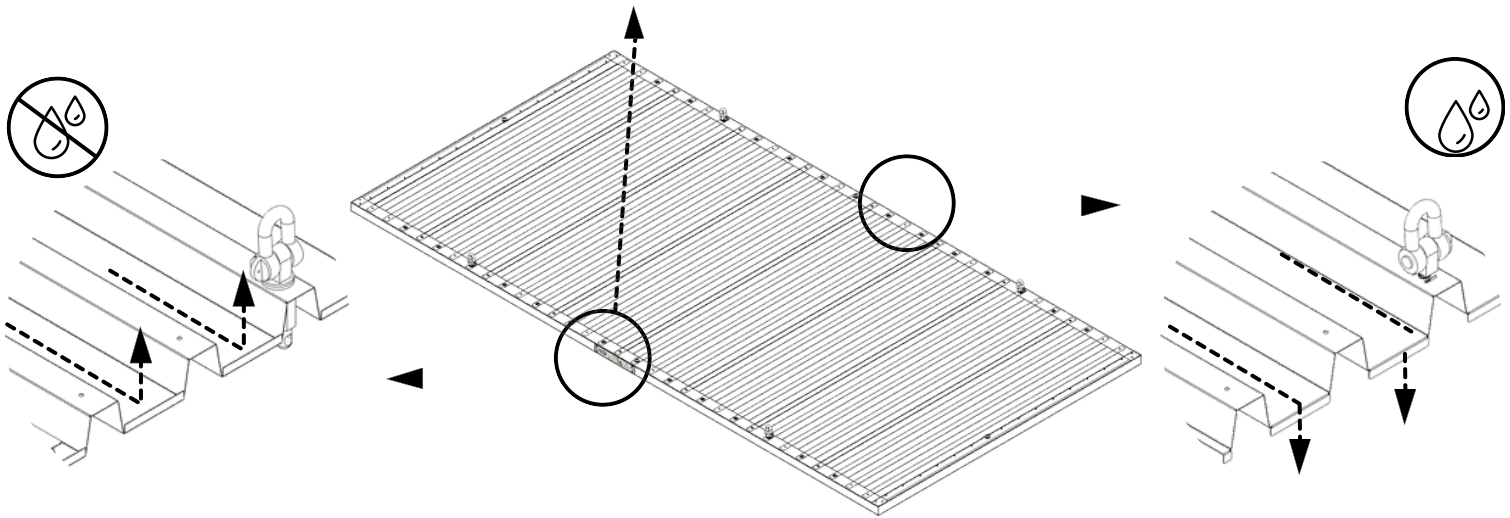

12

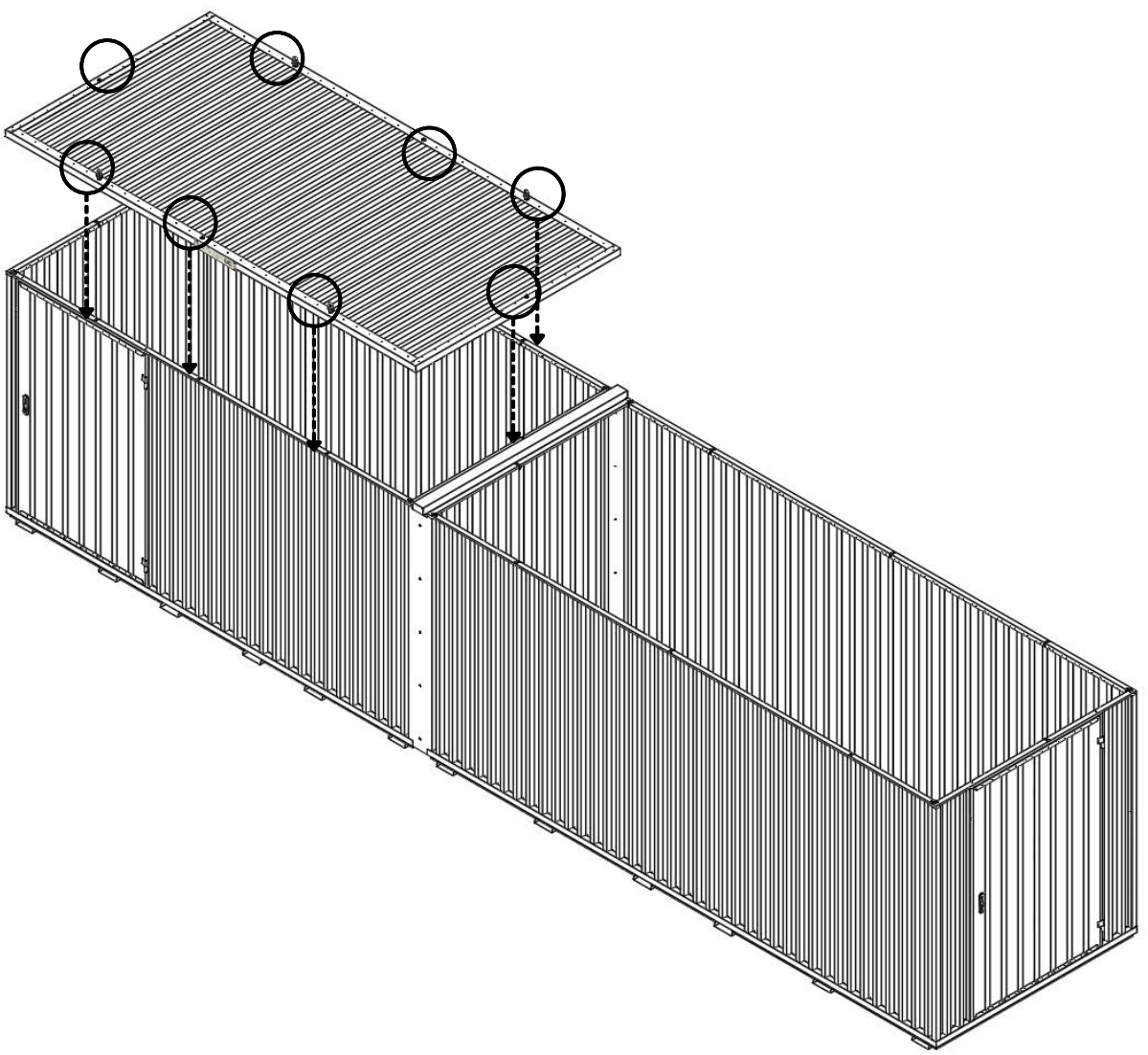

13

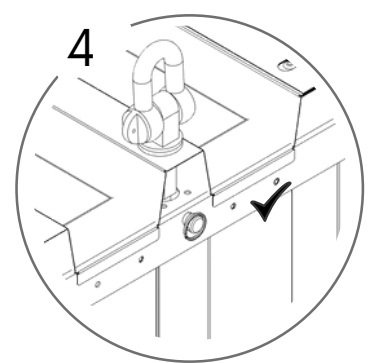
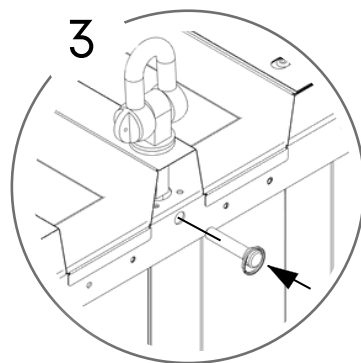
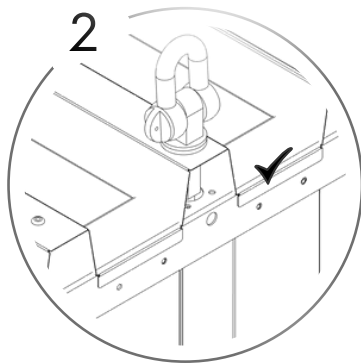
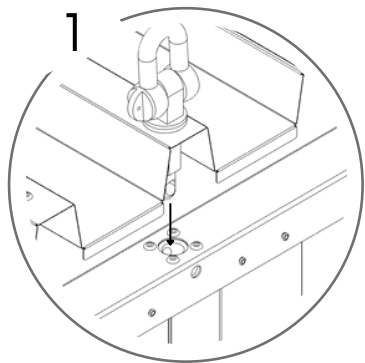
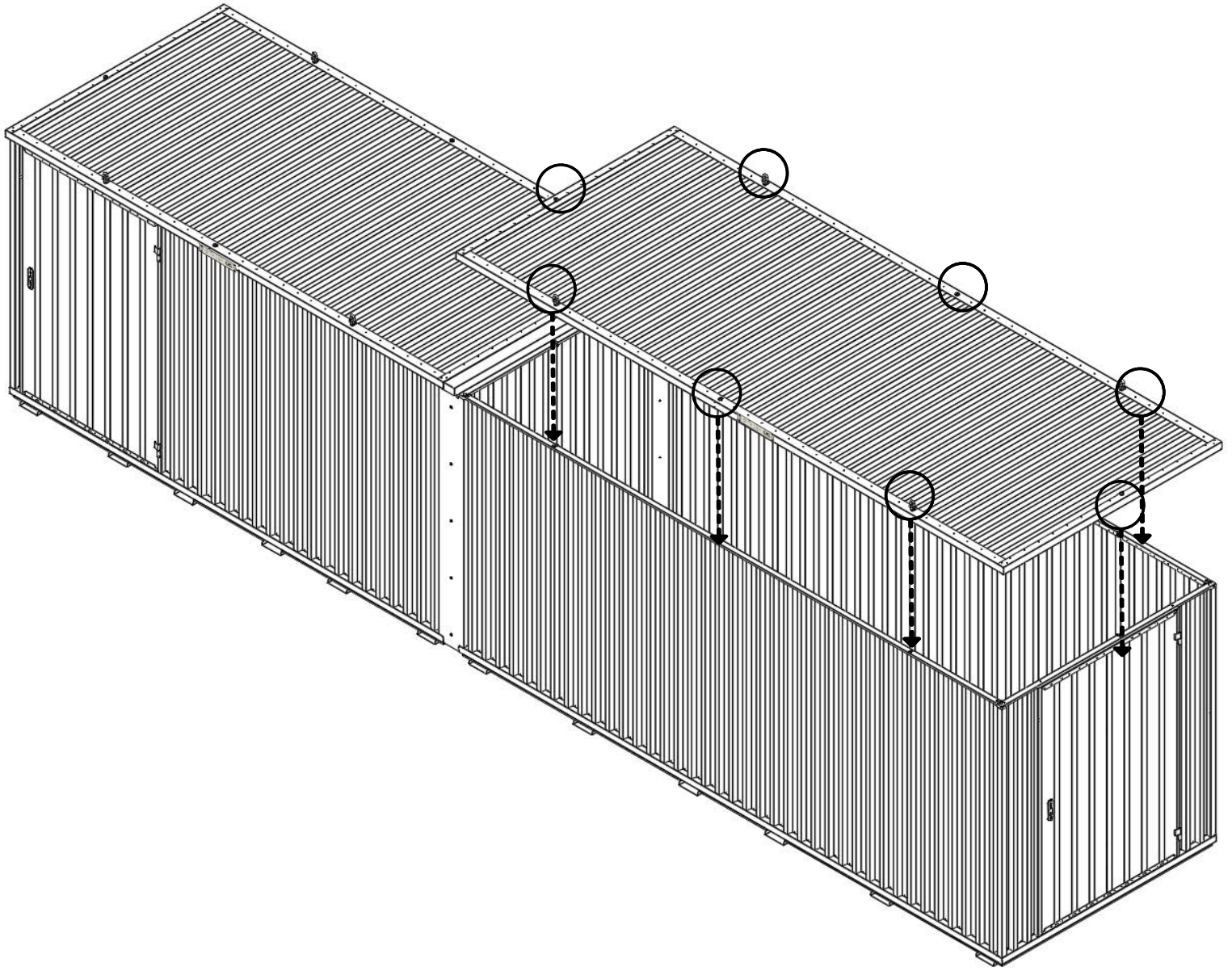

14

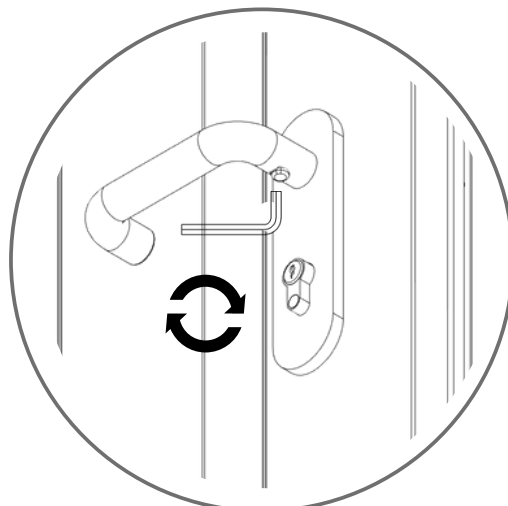
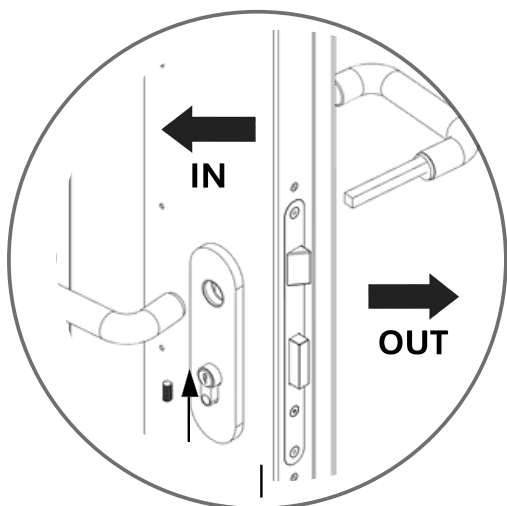
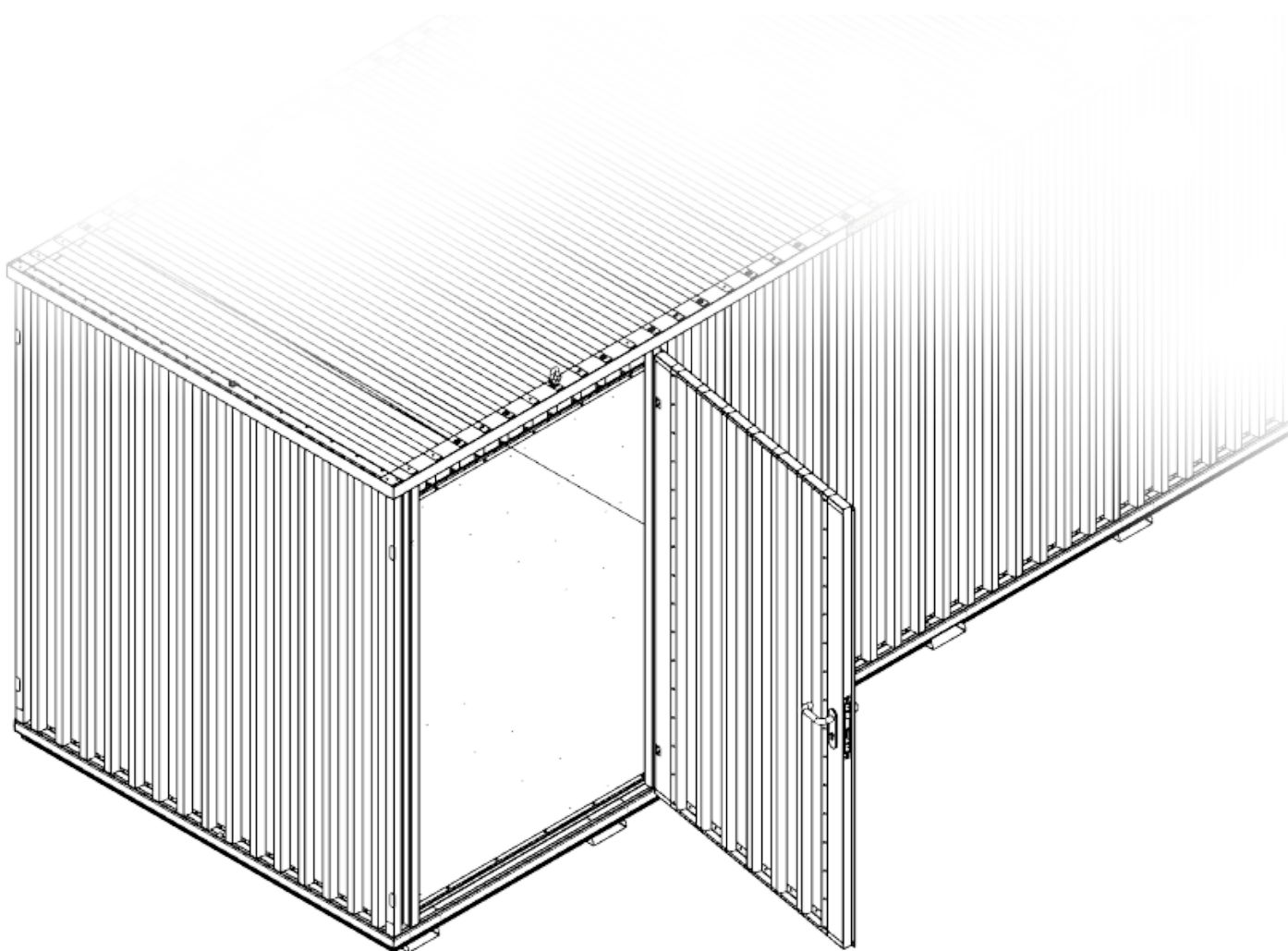

15

