

PRODUCT CODE:6060.110.450.320

prefabase
Quick Build Solutions

Instructions and User Guide

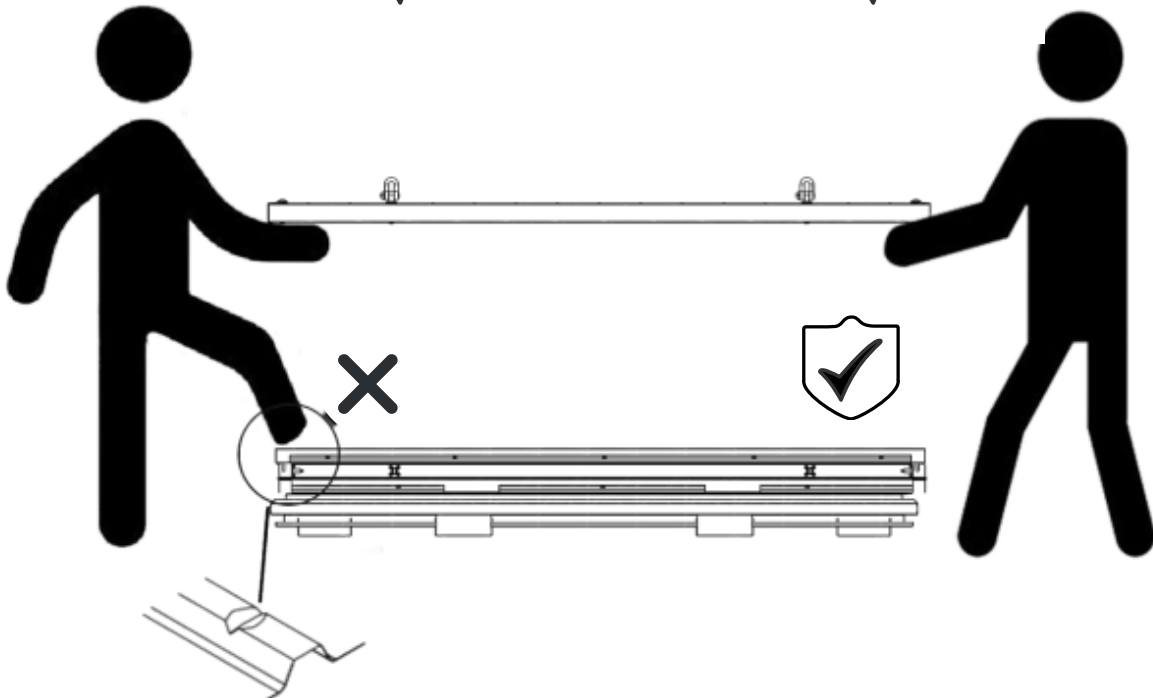
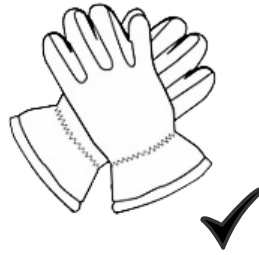
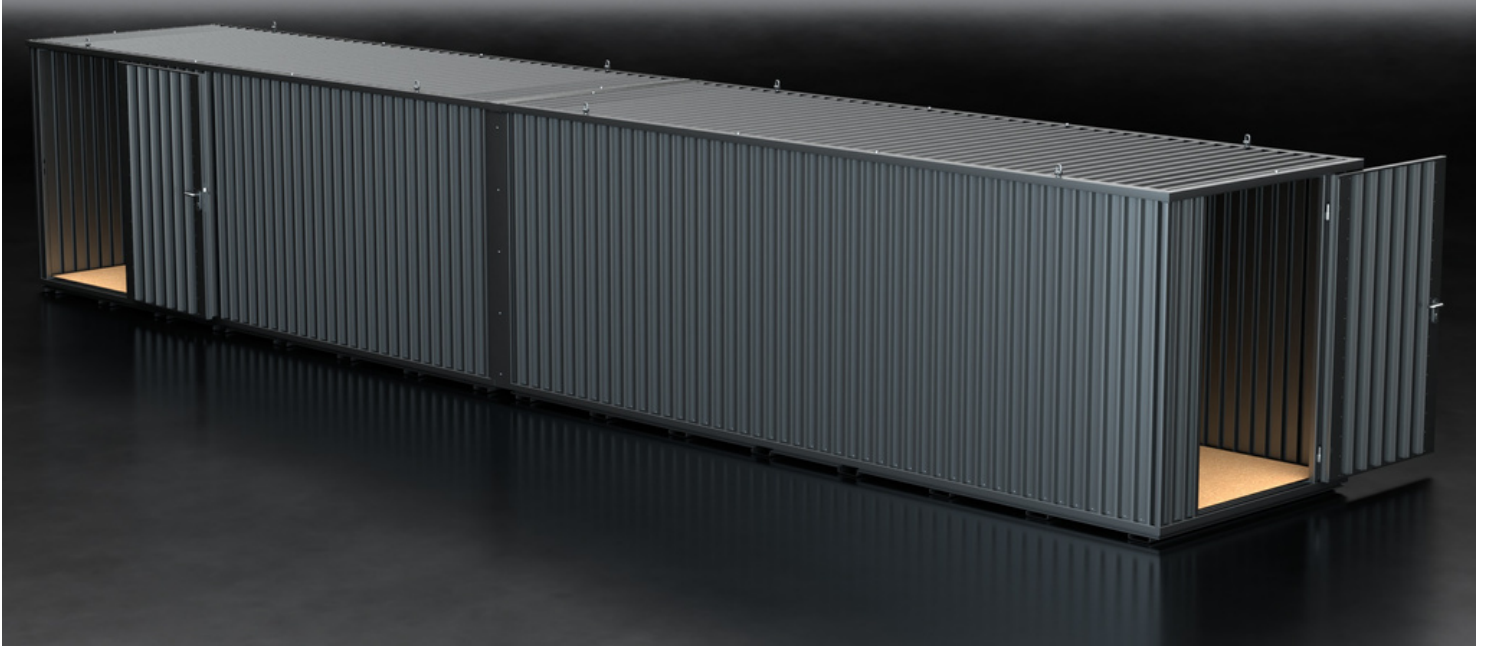

60.0110
2x

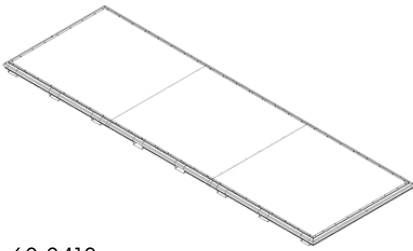

60.0510
2x

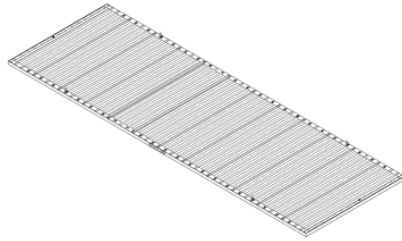

306.0110
1x



306.0510
1x



60.0410
3x

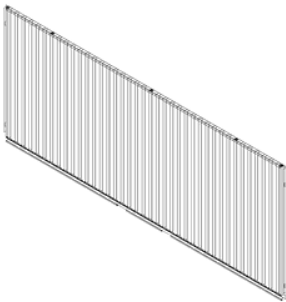

60.0450
1x

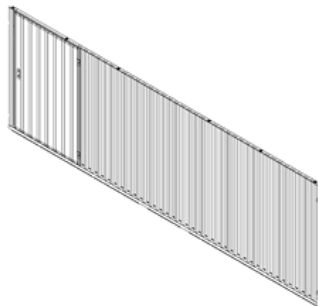

0310
1x

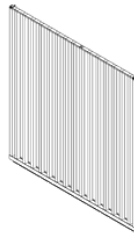

0320
1x



306.40.05
2x



306.40.04
2x



61.101
4x



28x



2x

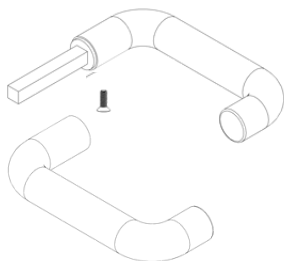

10x



10x



10x



1x



2x



1

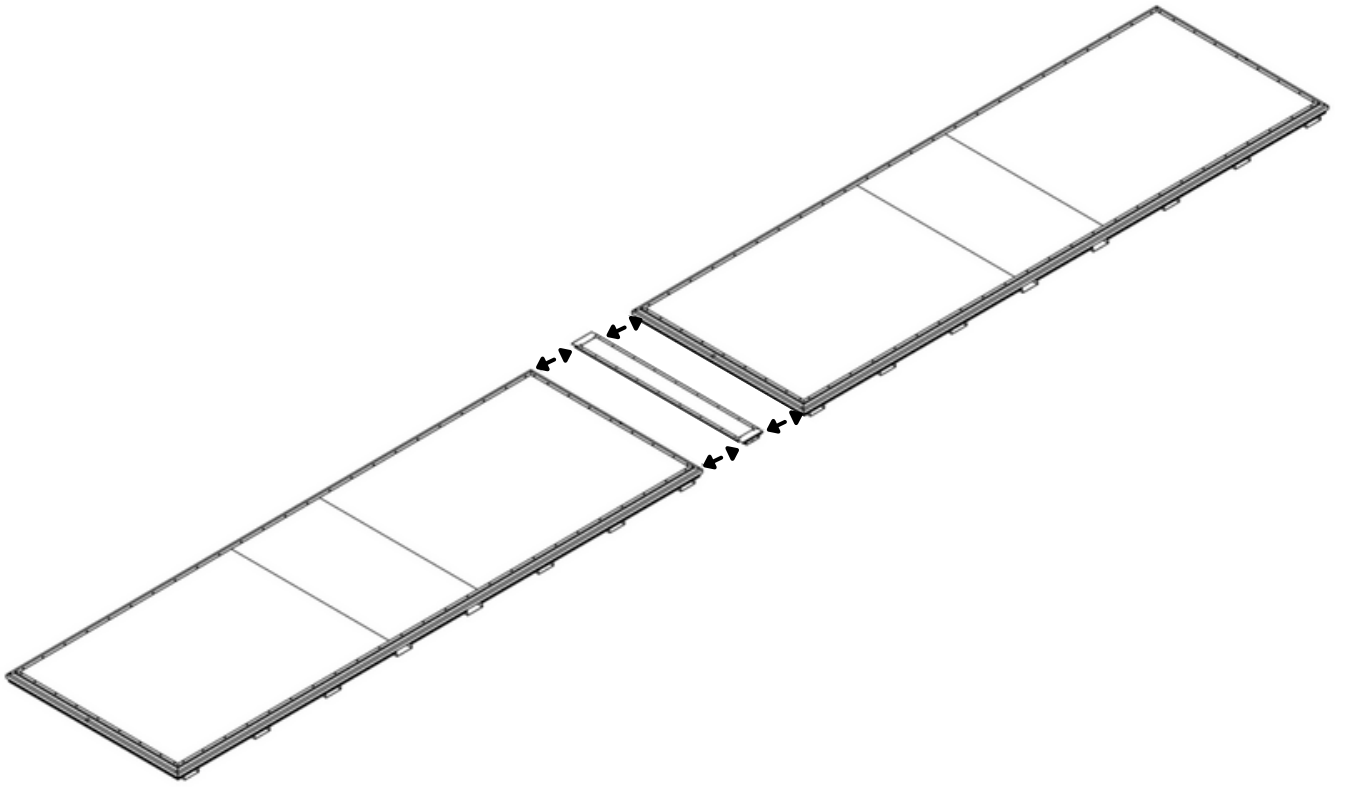

2

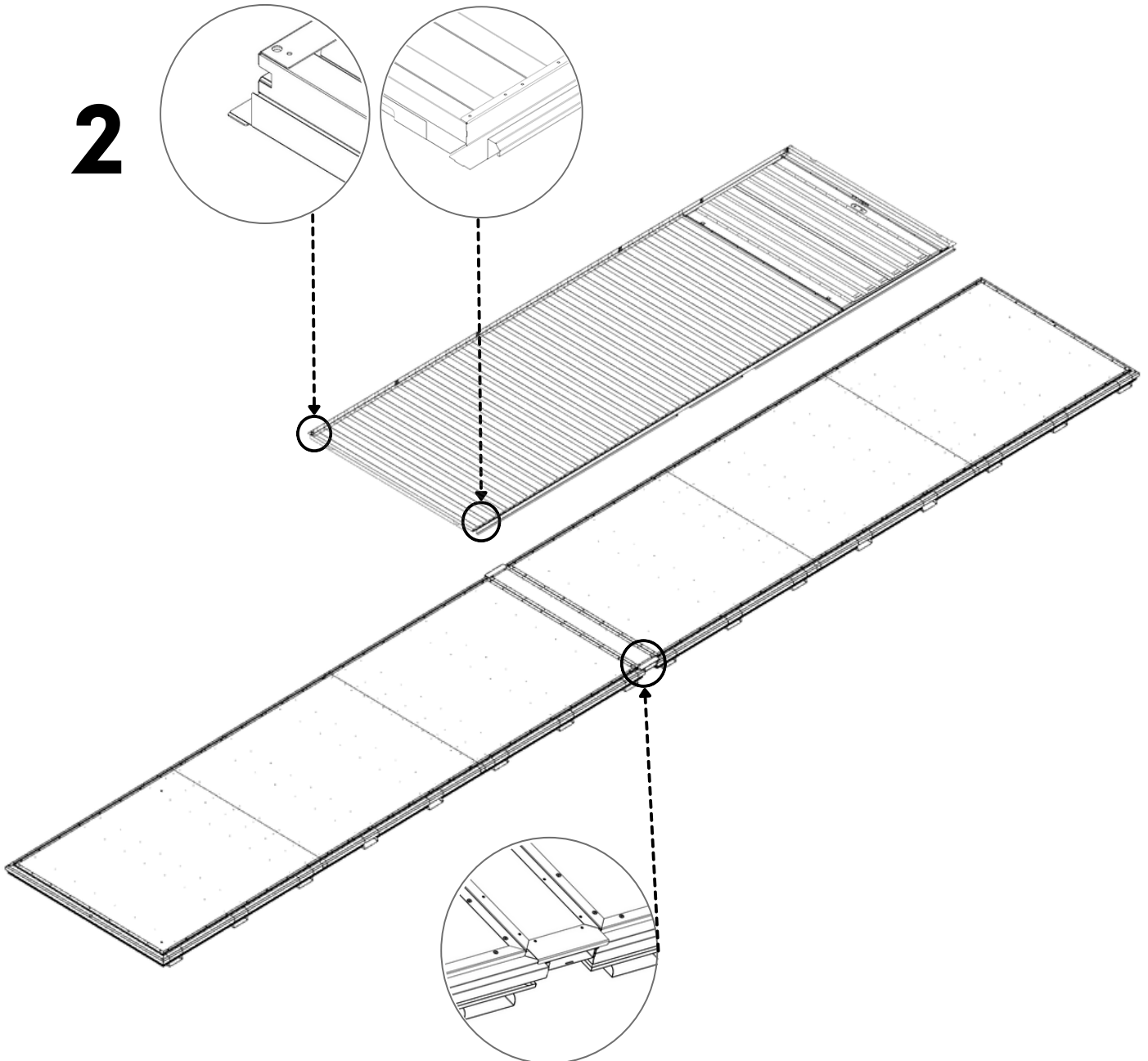

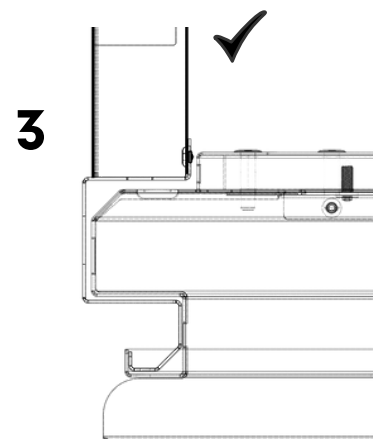
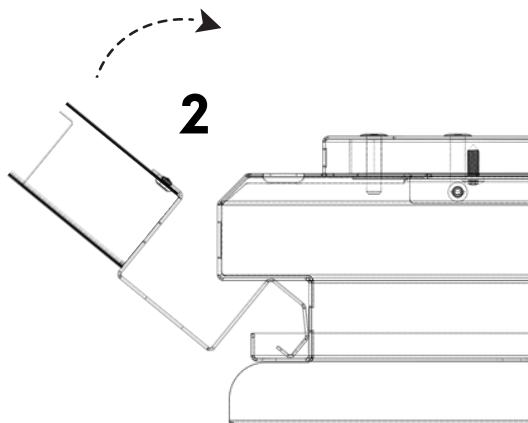
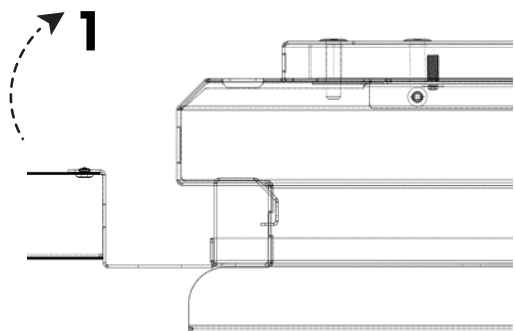

3

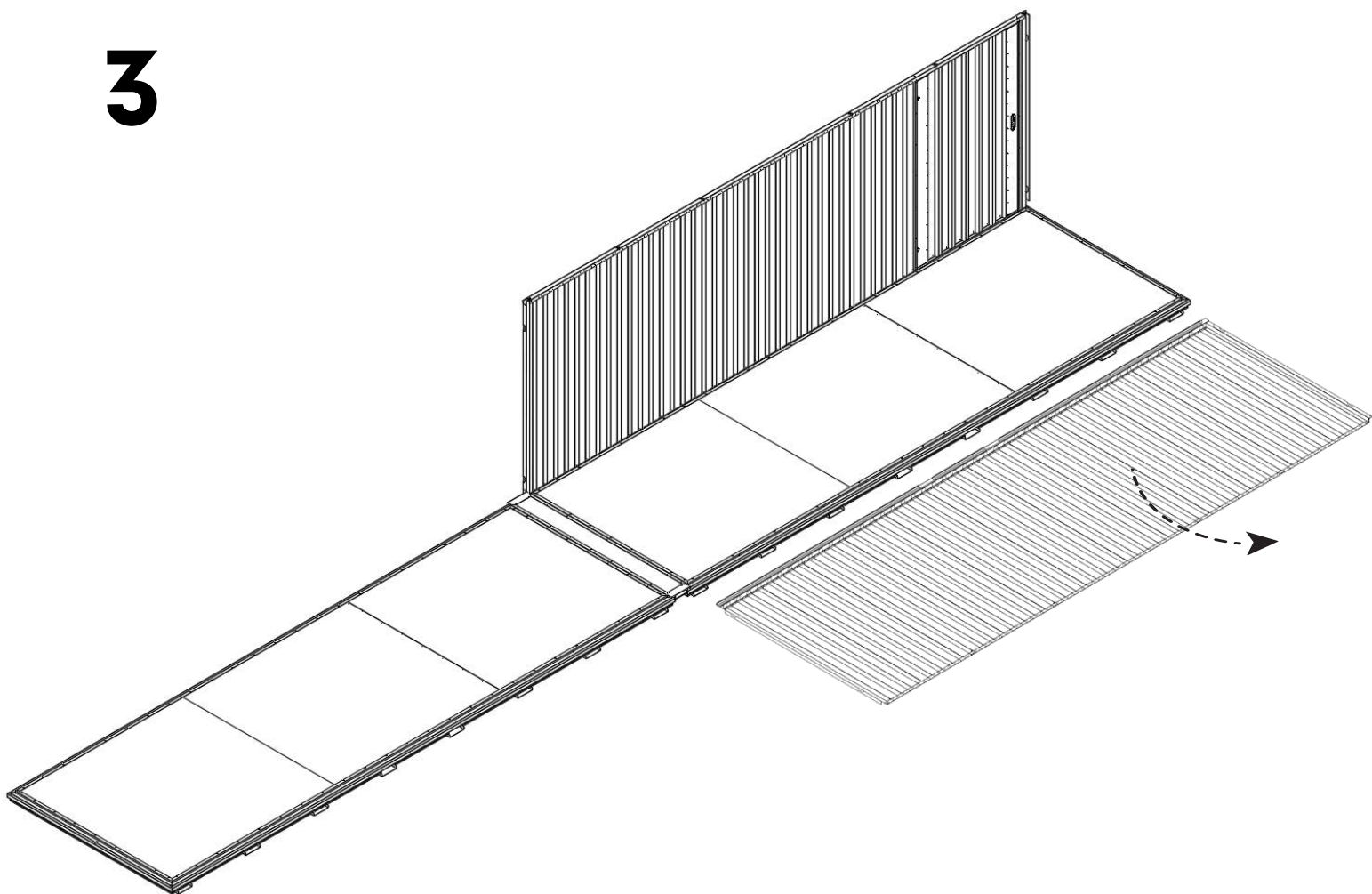

4

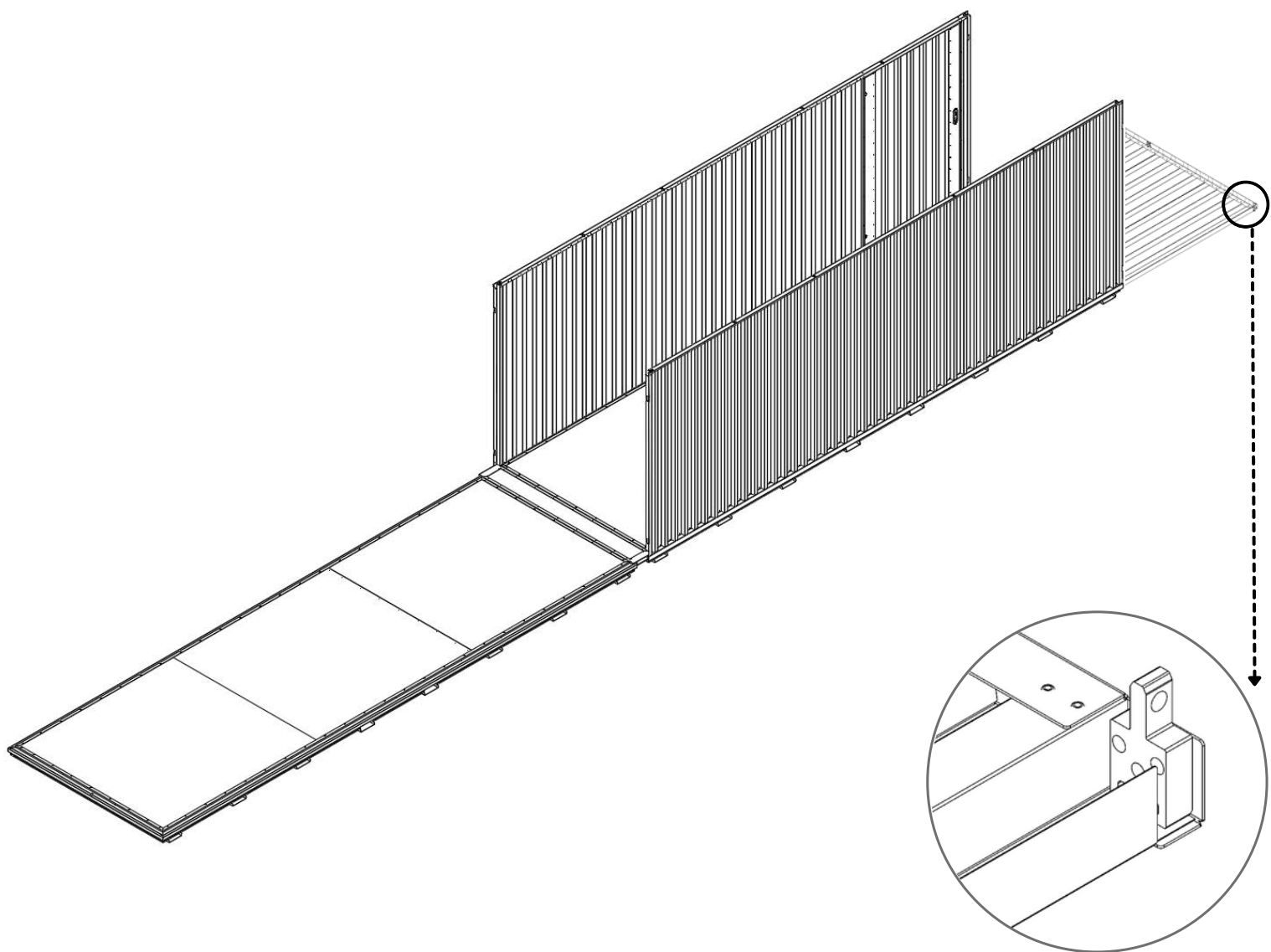

4.1

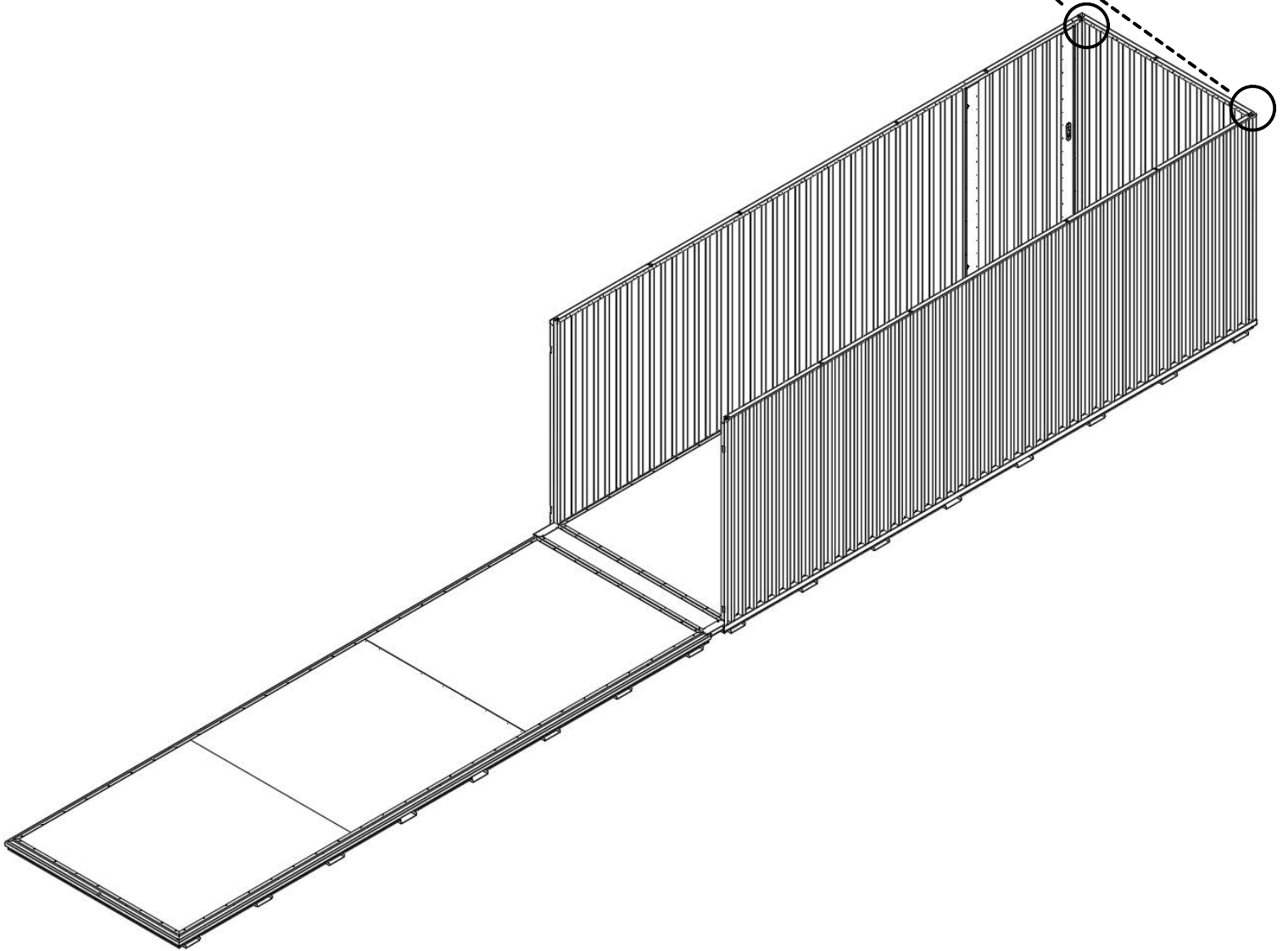
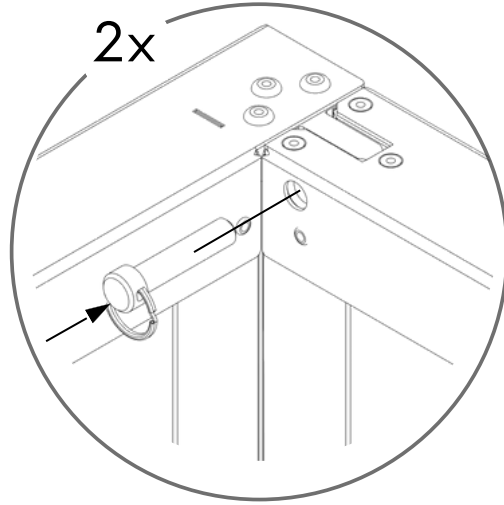

5

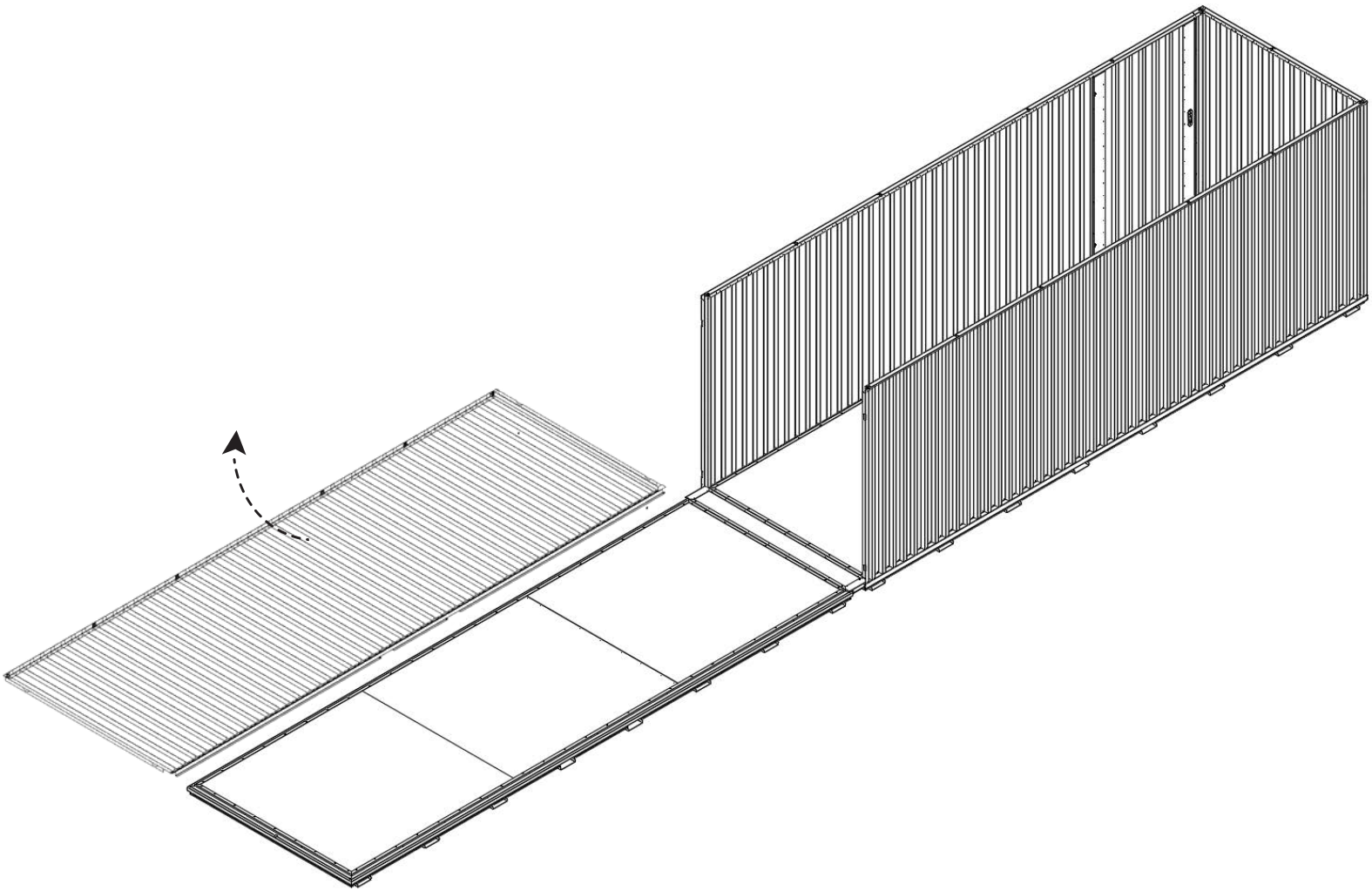

6

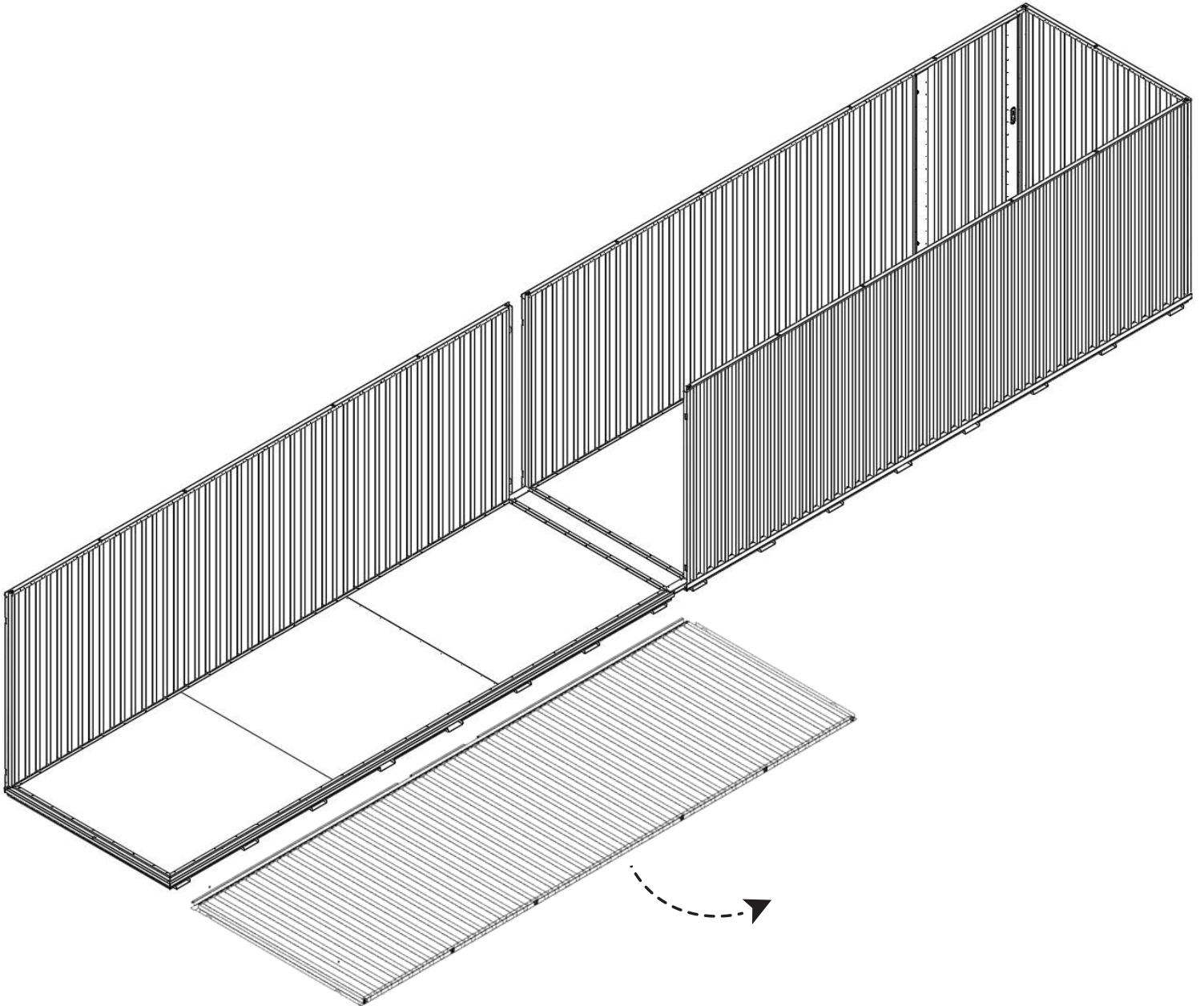

7

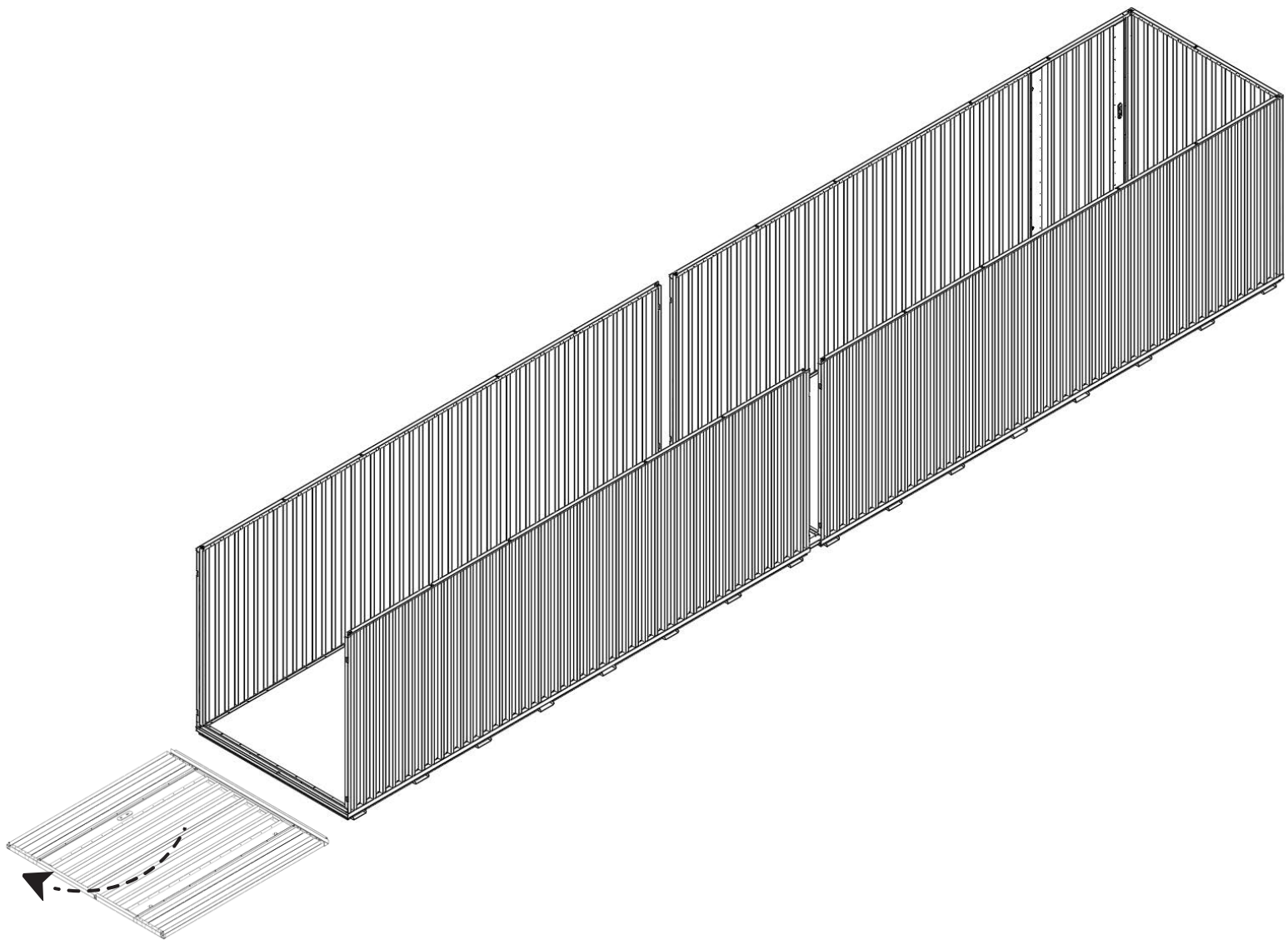

7.1

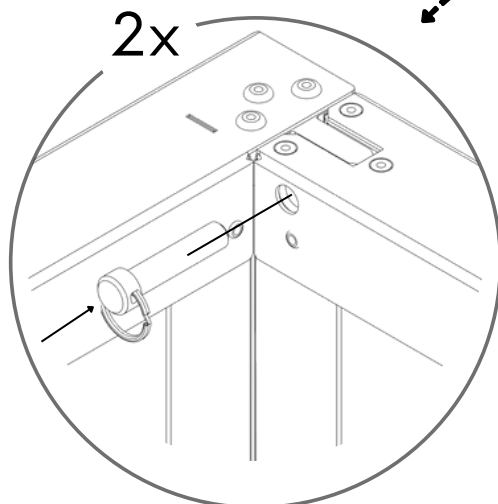
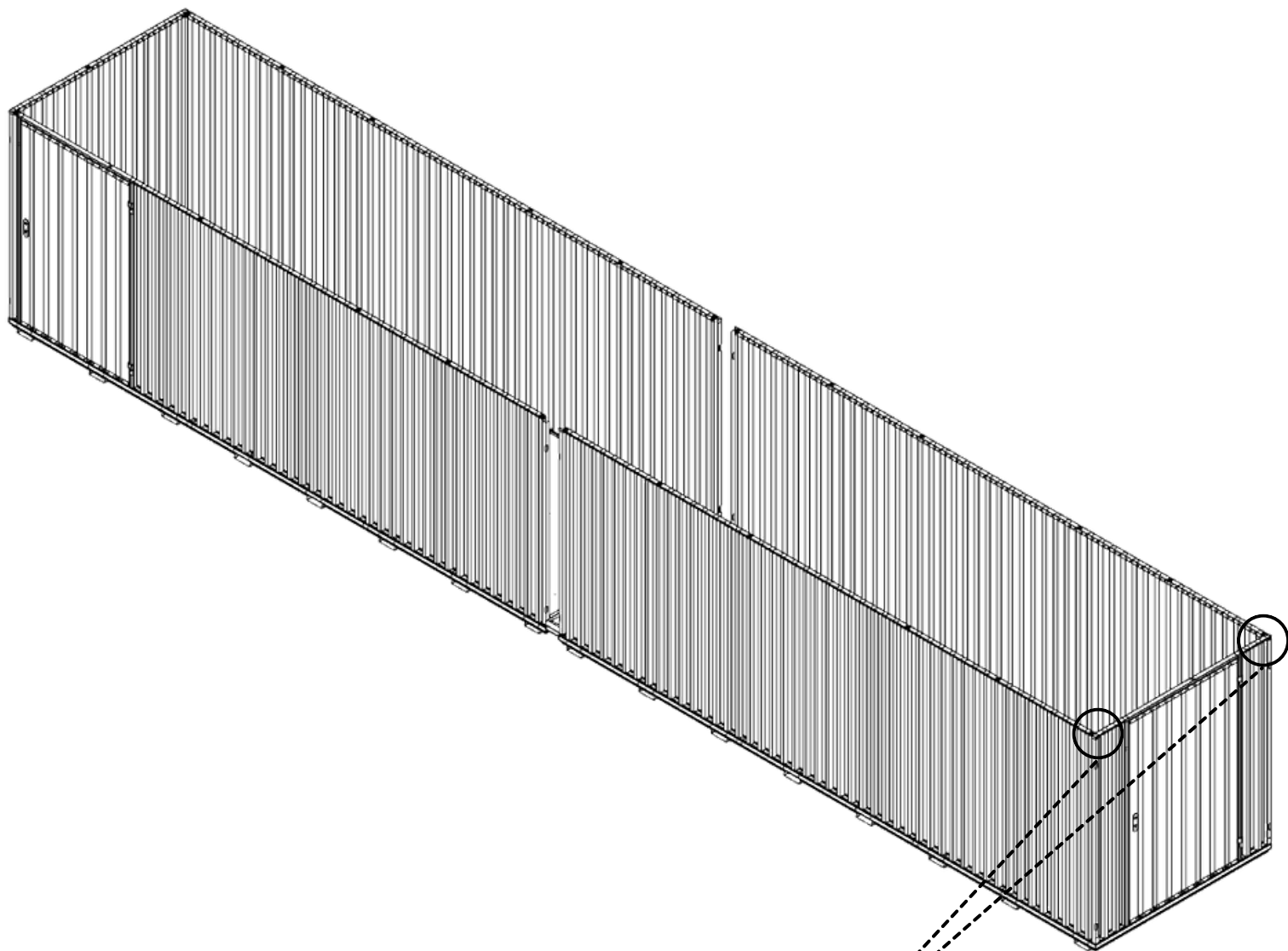

8

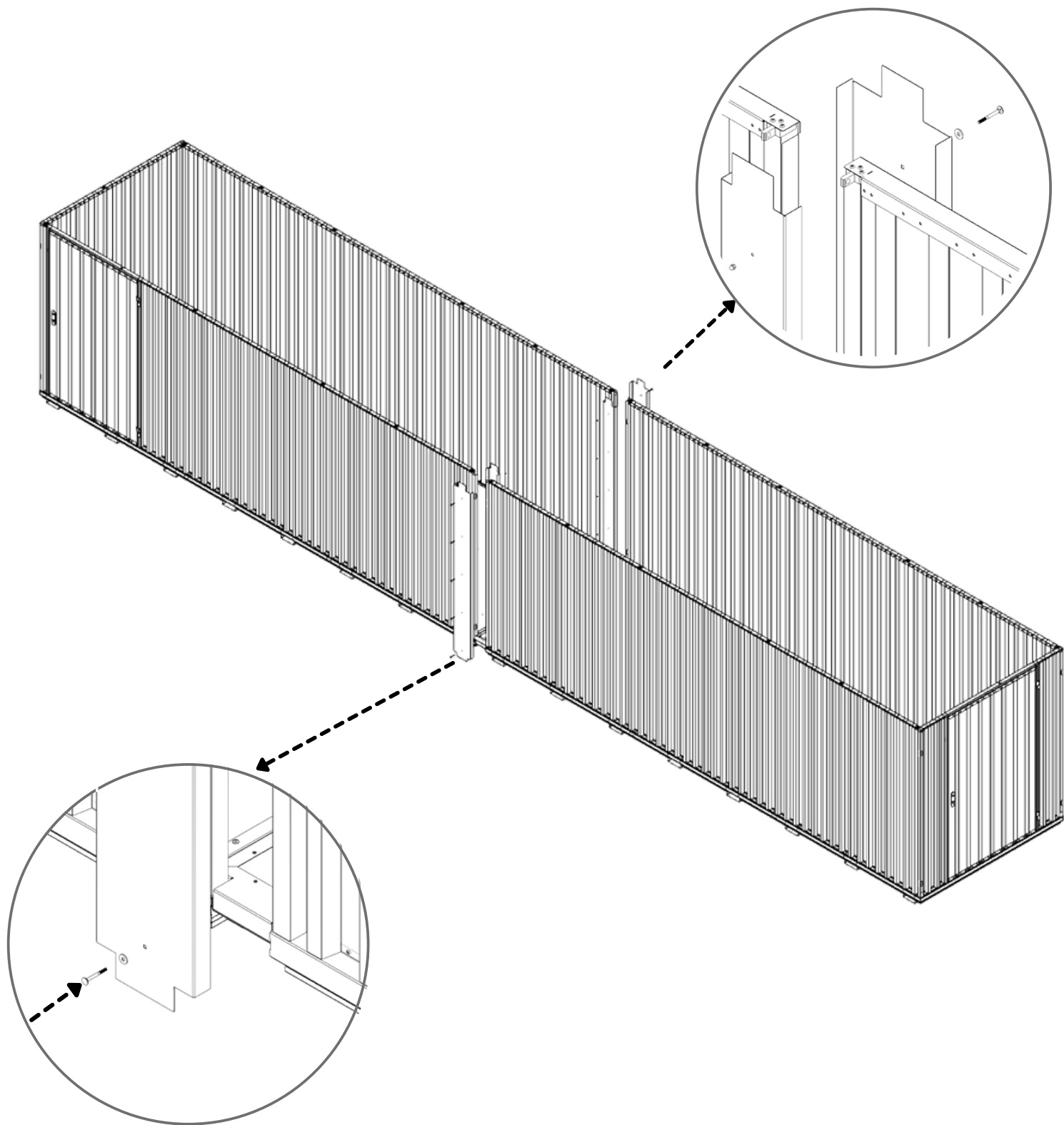

9

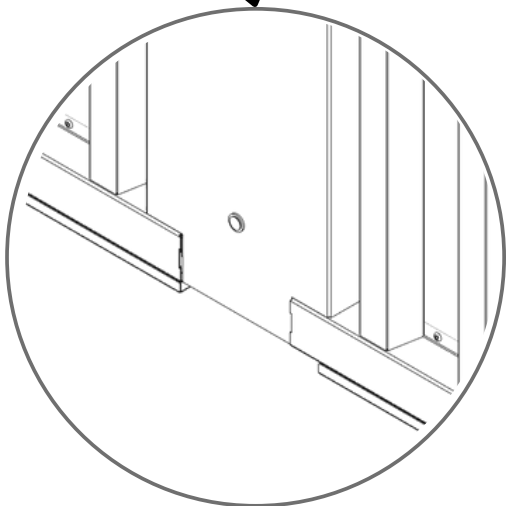
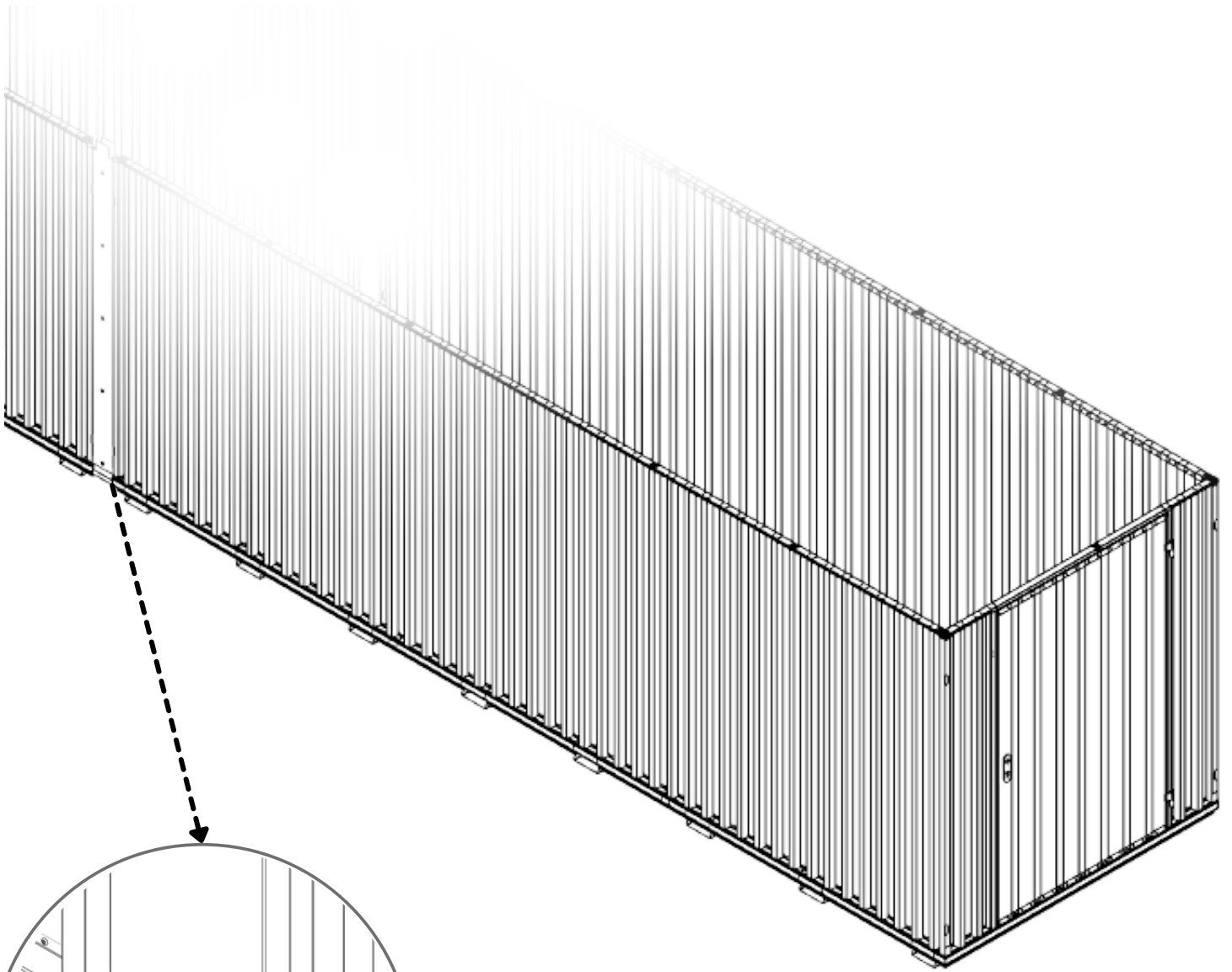



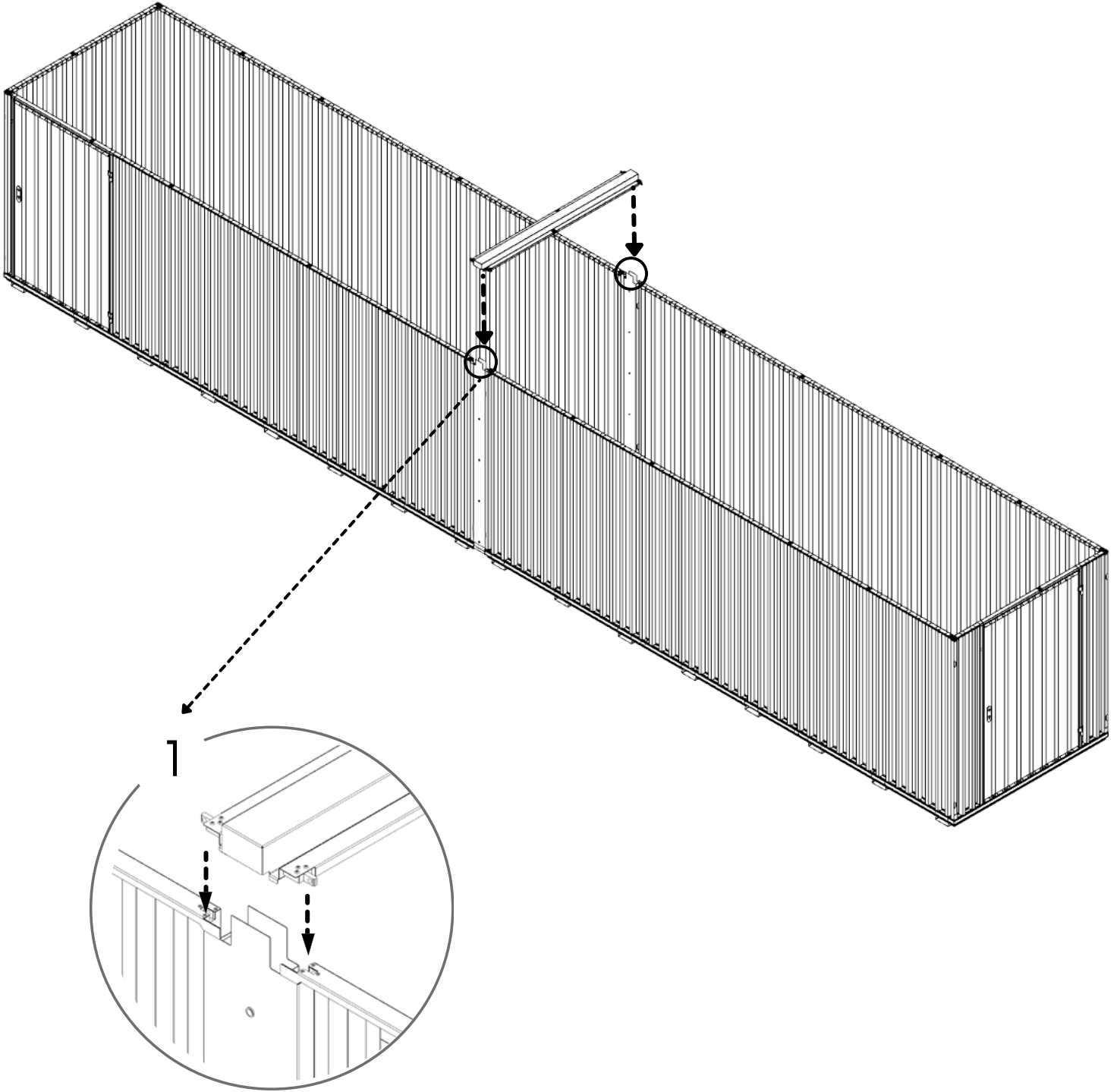



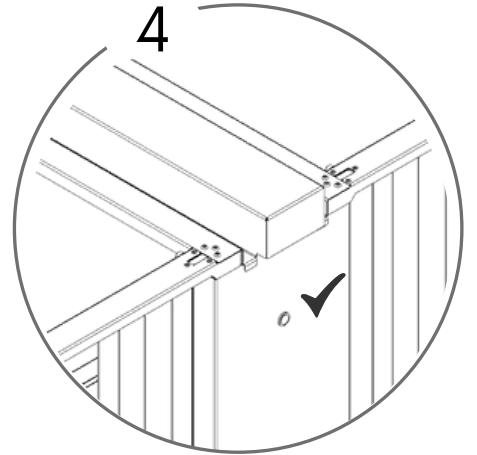
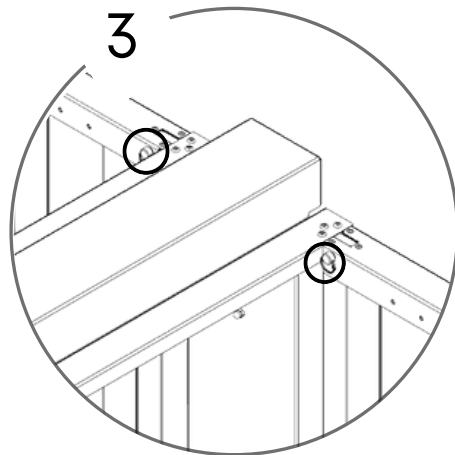
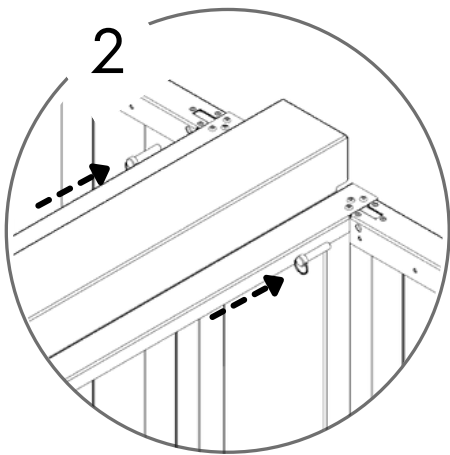
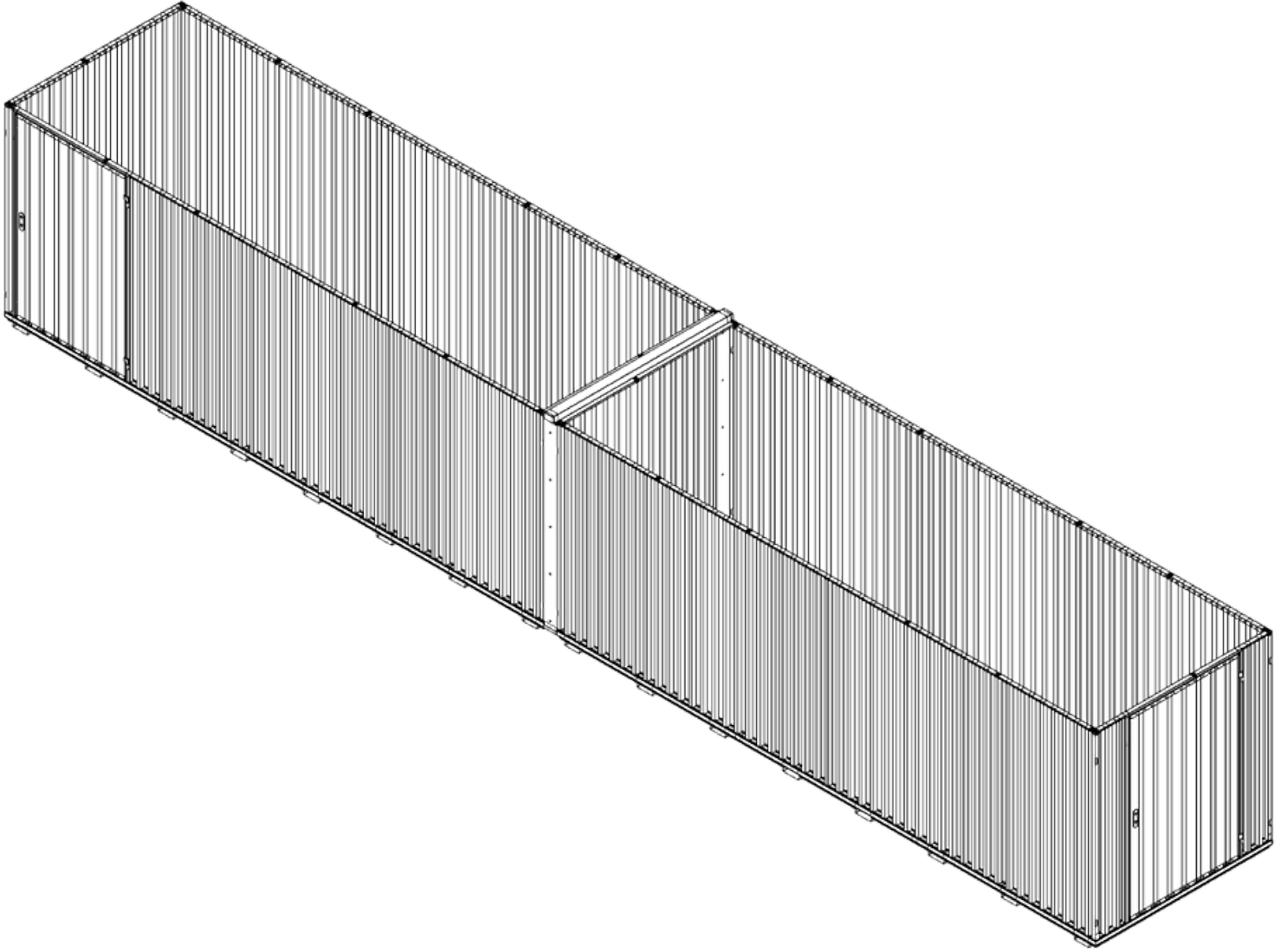

10



11





 1128 KG	 1640 MM	Model Code: 6060.110.450.320 Production Tracking Code:/X09.1.6060.450.320	 9001	 14001	 50001			
--	--	---	---	--	--	---	---	---

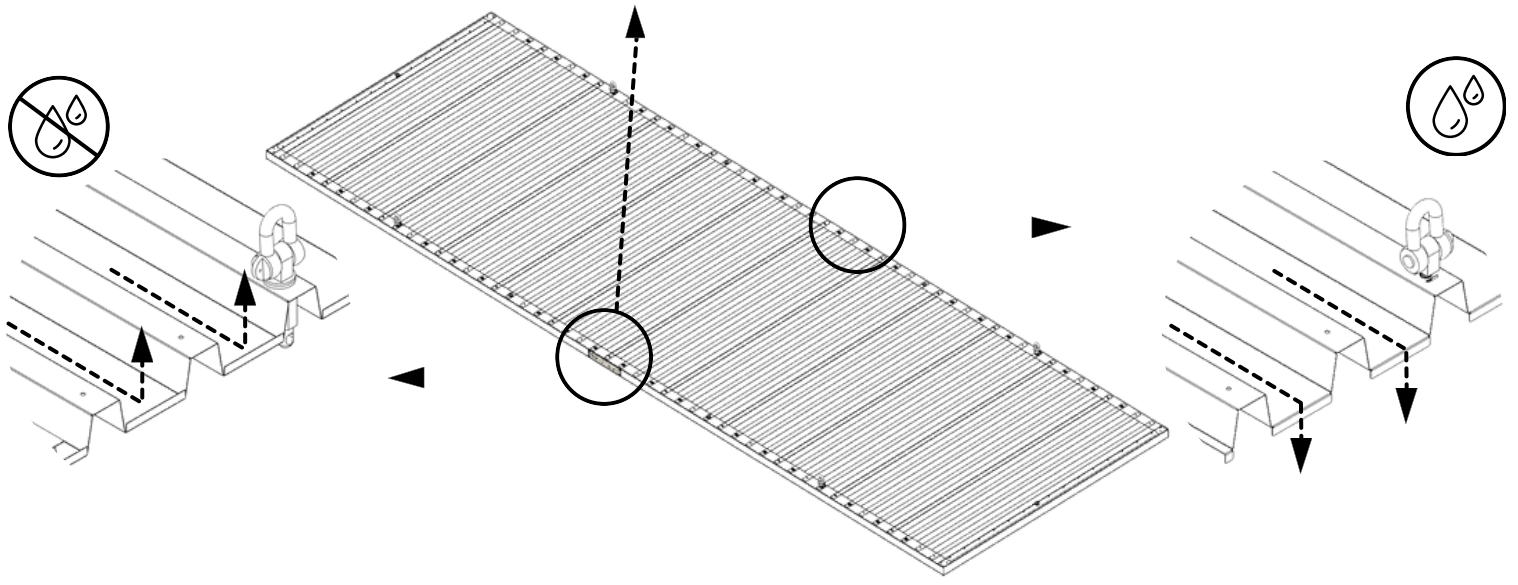

12

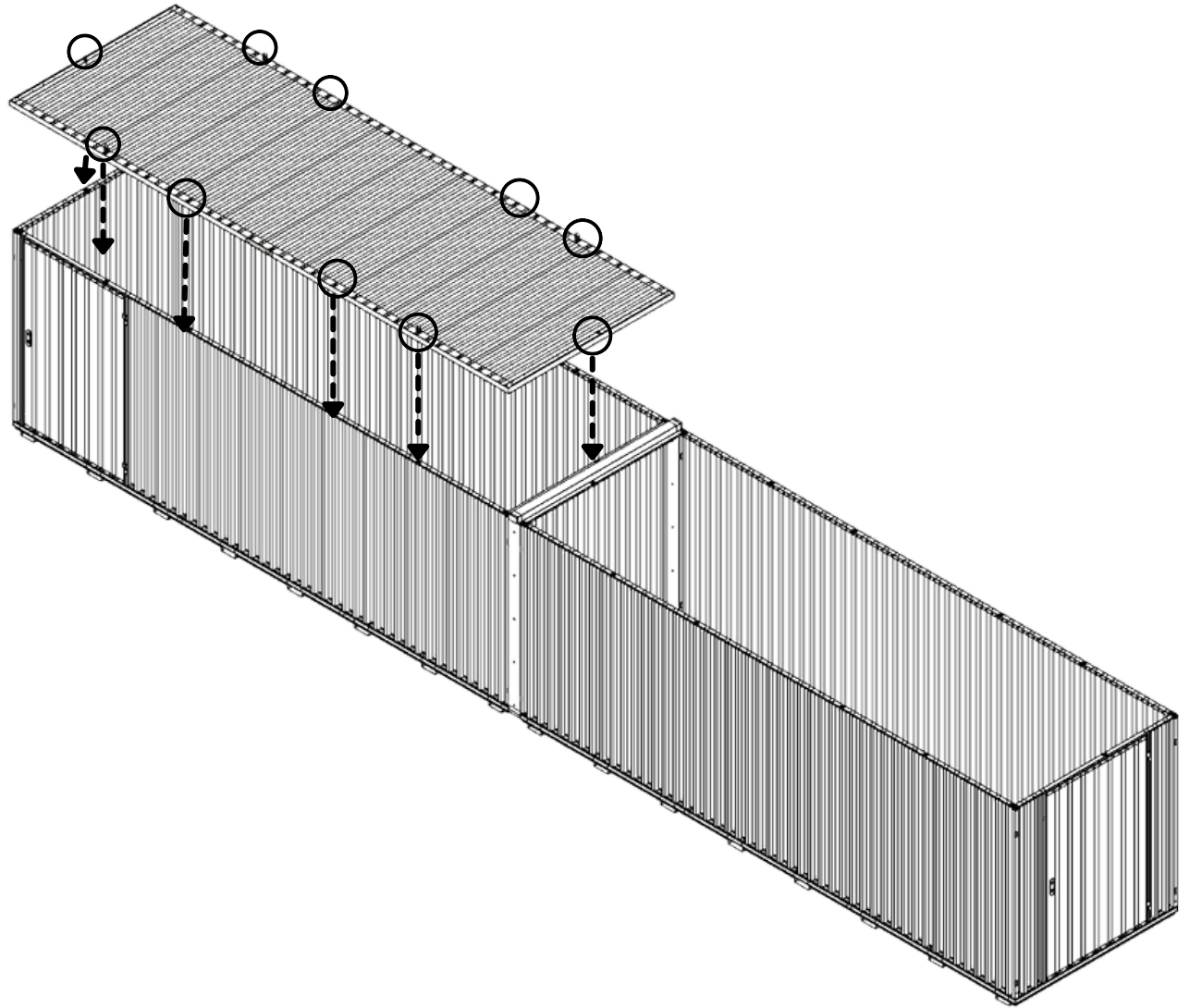

13

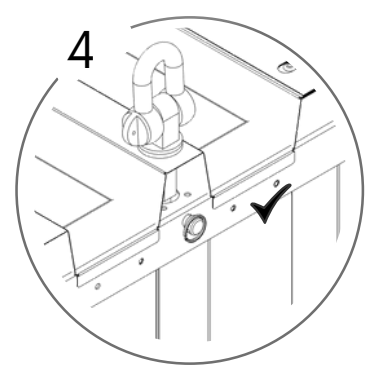
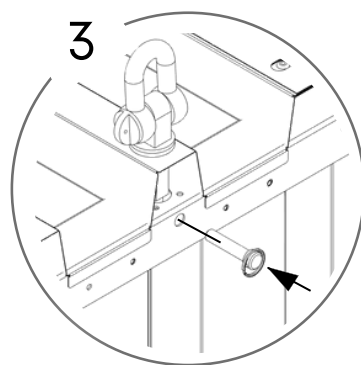
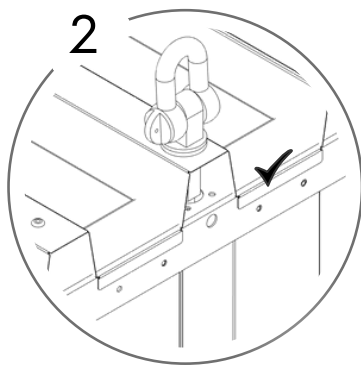
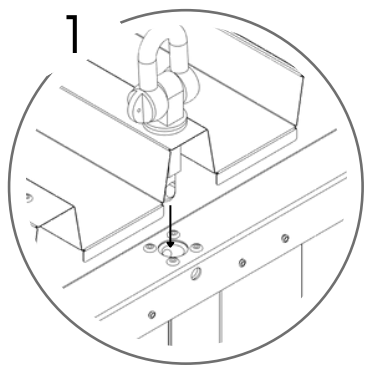
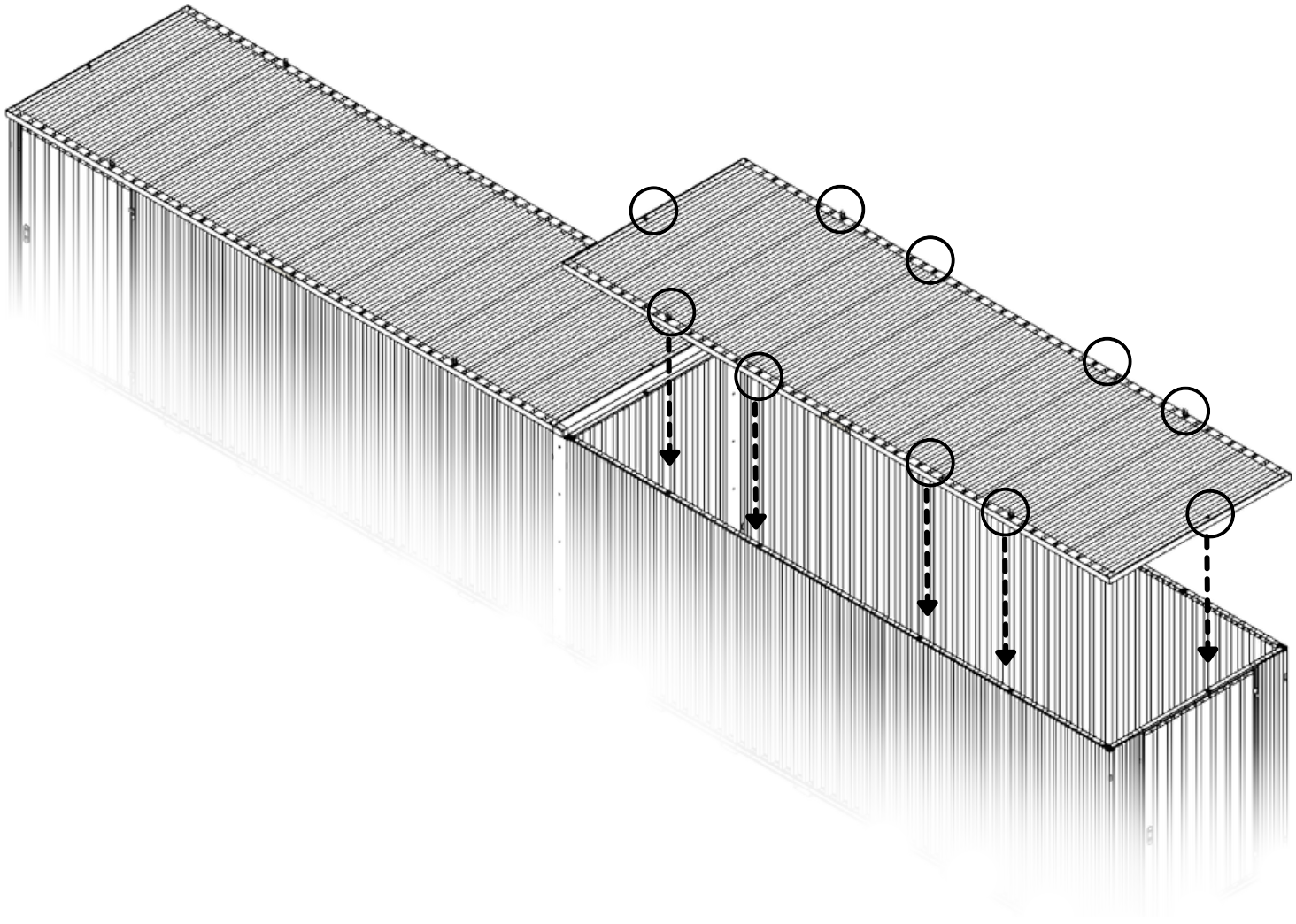

14

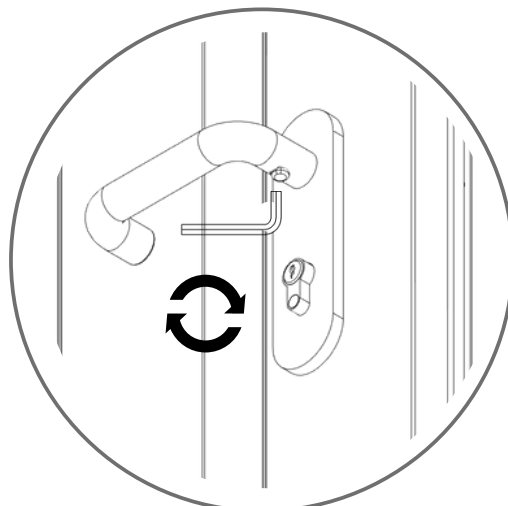
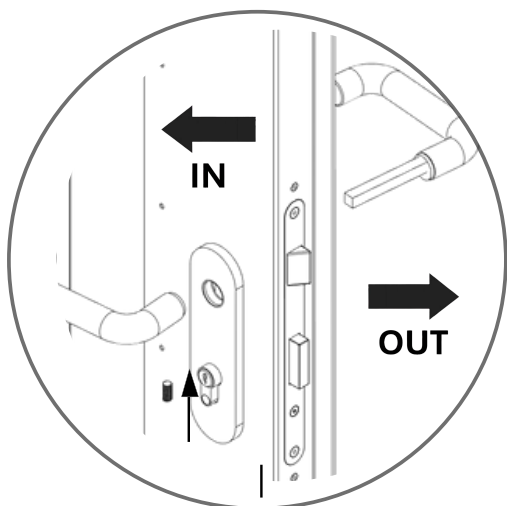
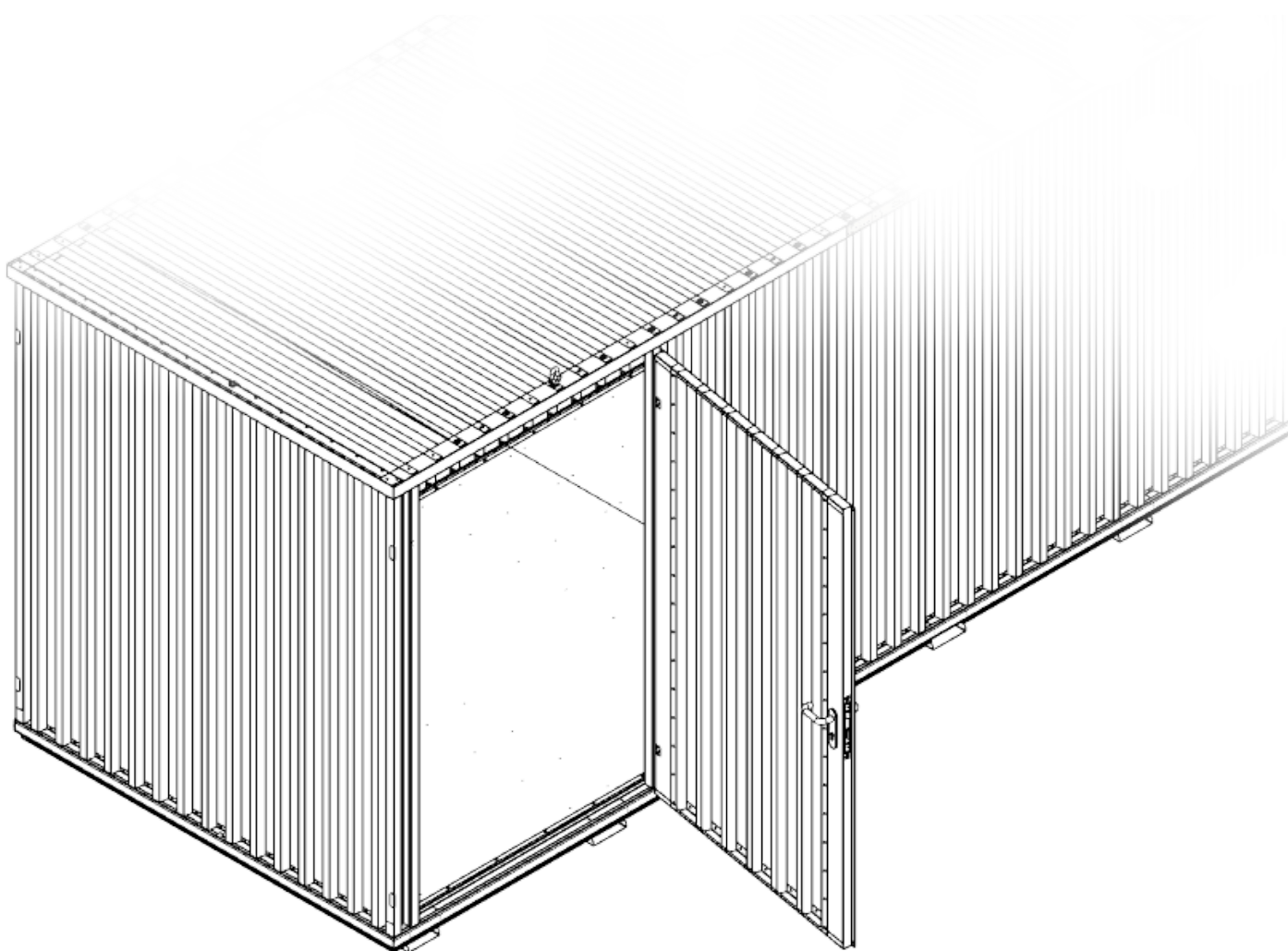

15

