

PRODUCT CODE:60.110.440.330

prefabase
Quick Build Solutions

Instructions and User Guide

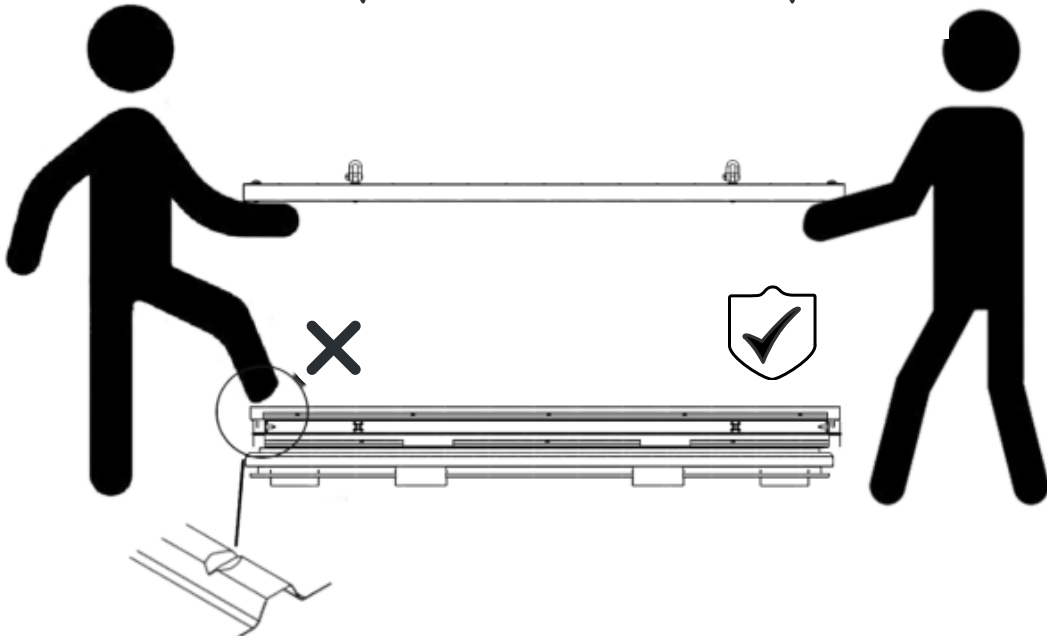
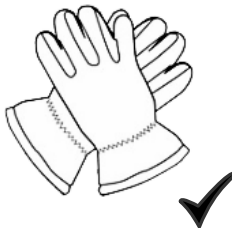

60.0110

1x

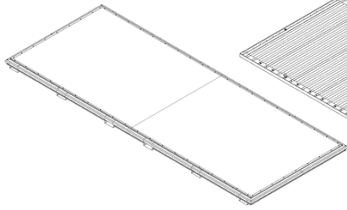

60.0510

1x

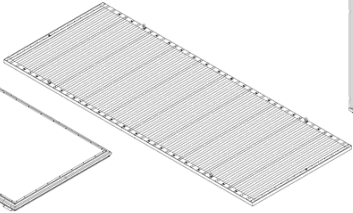

60.0410

1x

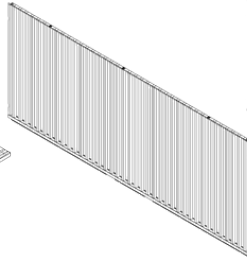

60.0440

1x

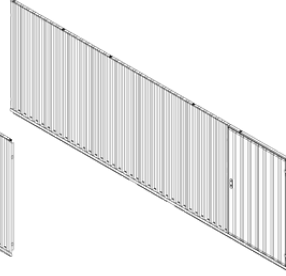

0310

1x

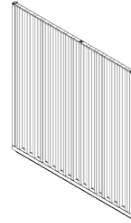

0330

1x



61.101

4x



14x

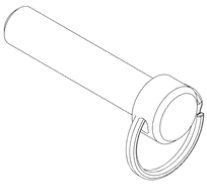

2x

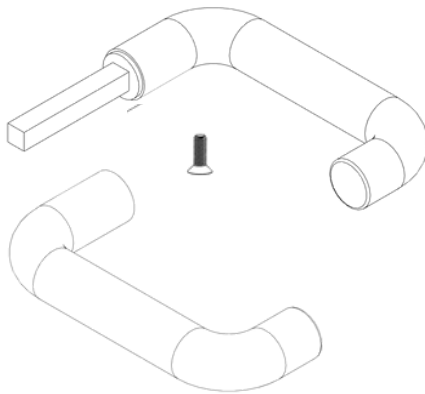

1x

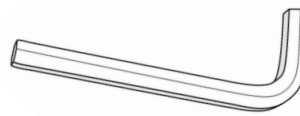

2x



1

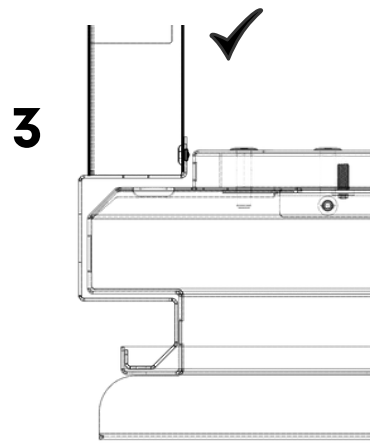
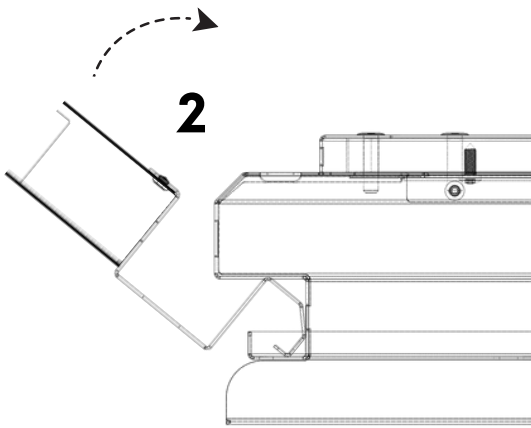
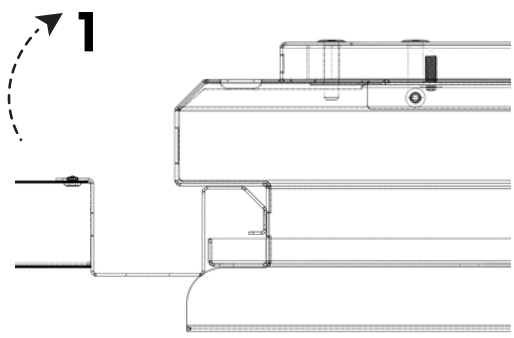
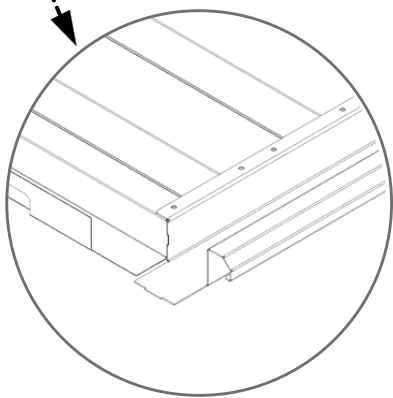
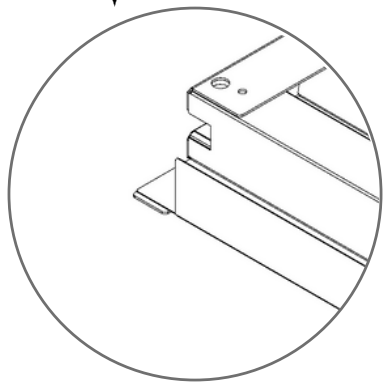
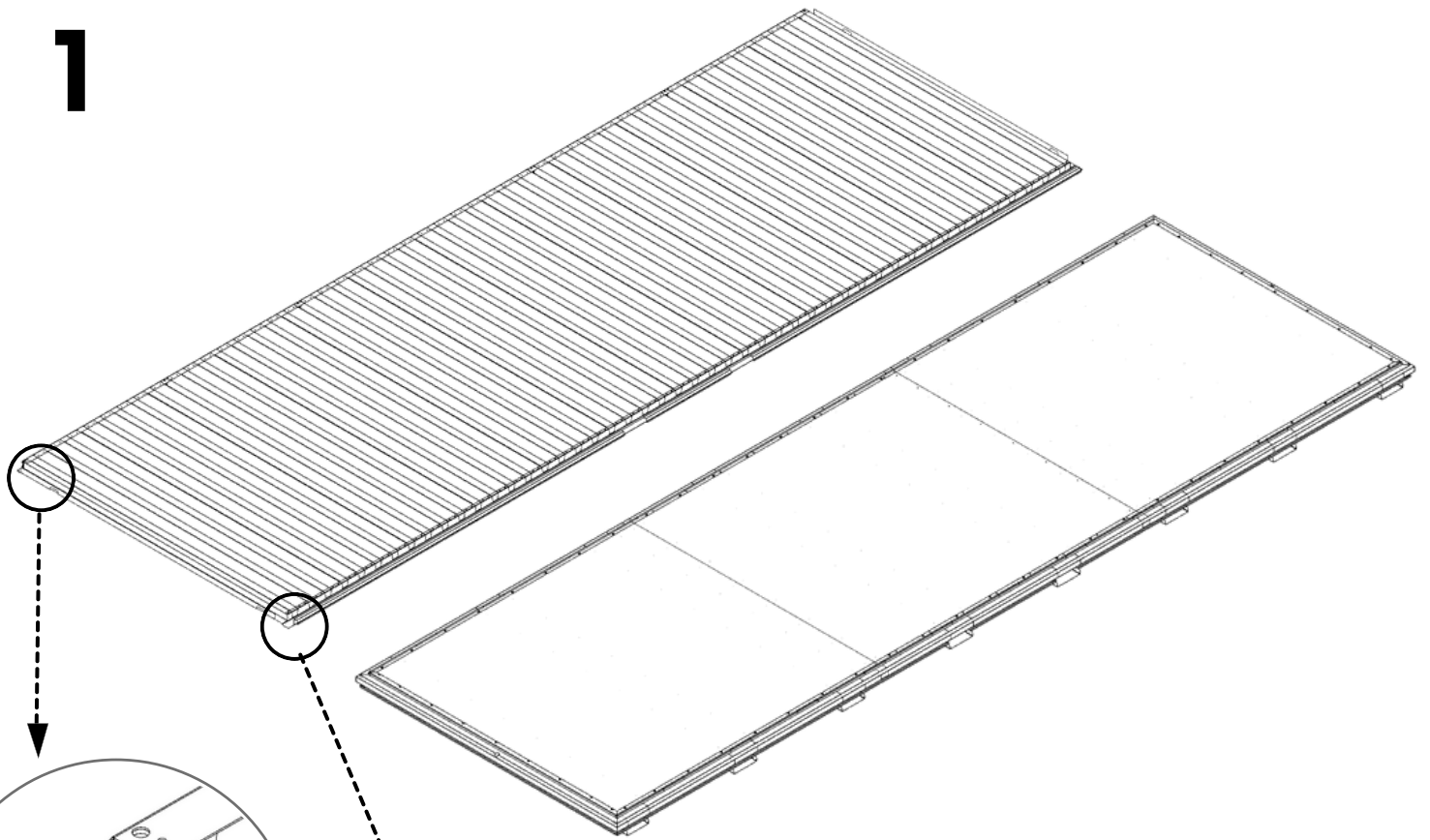

2

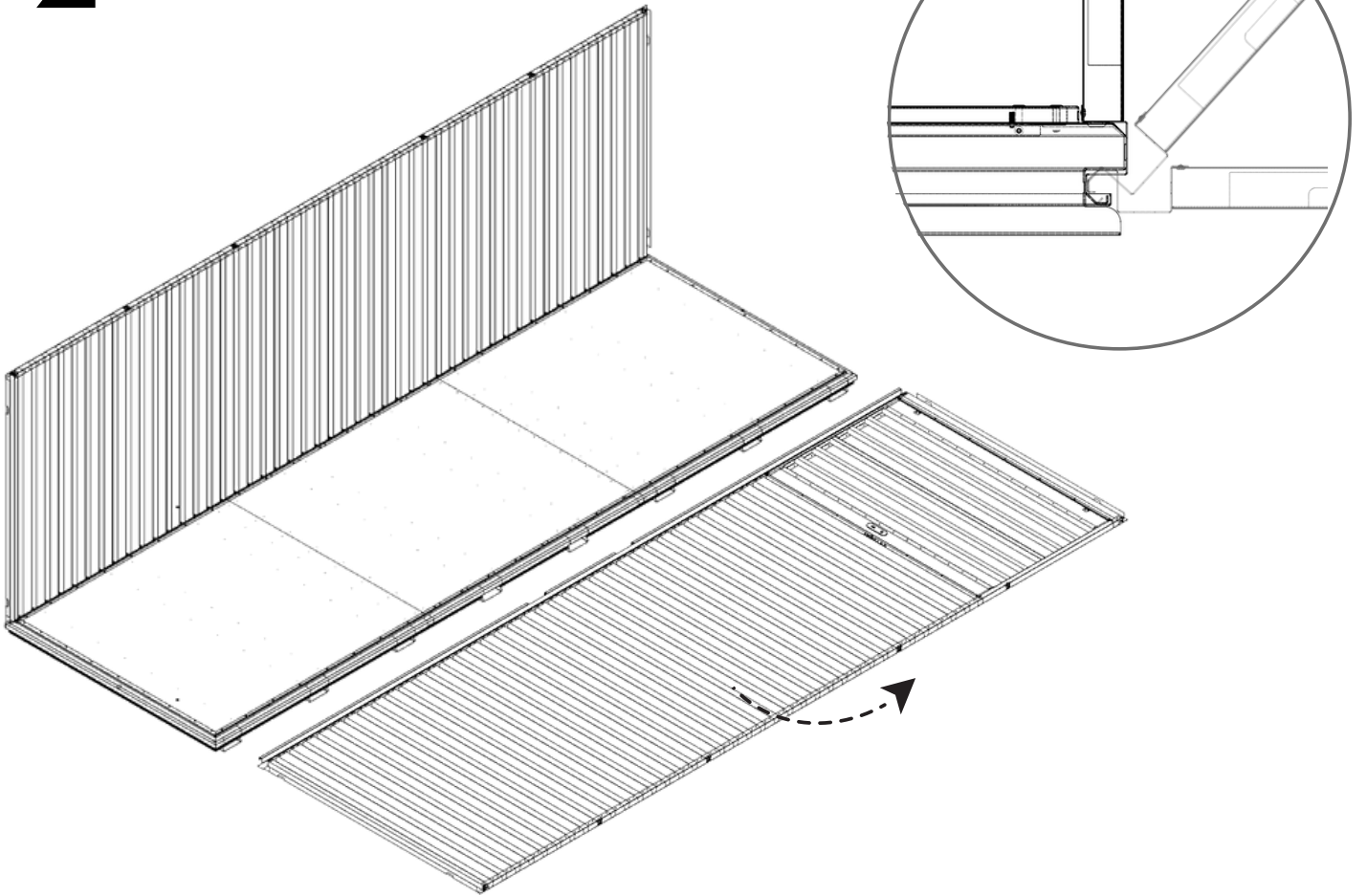

3

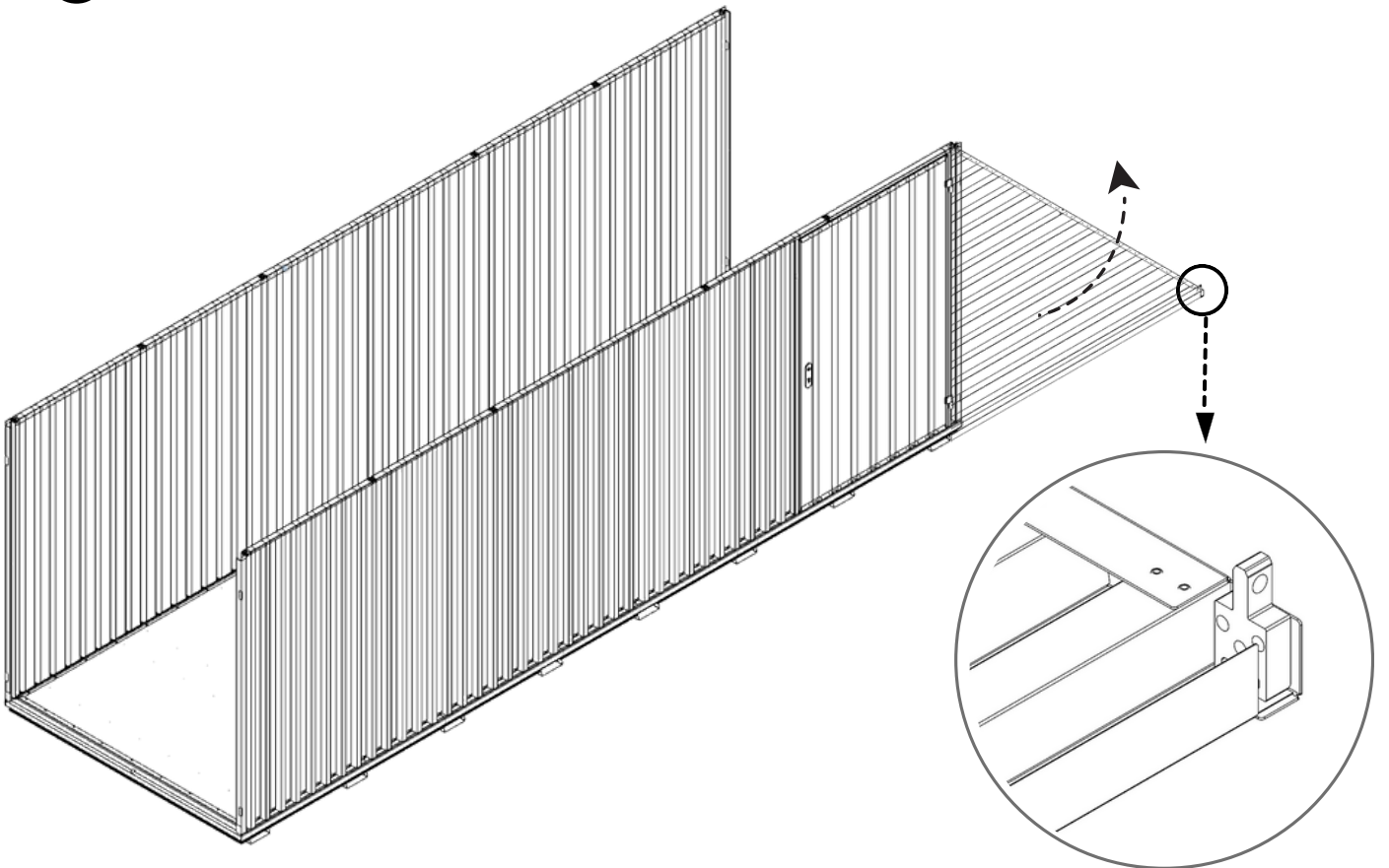

3.1

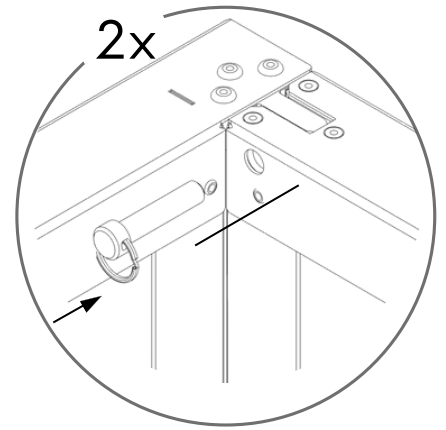
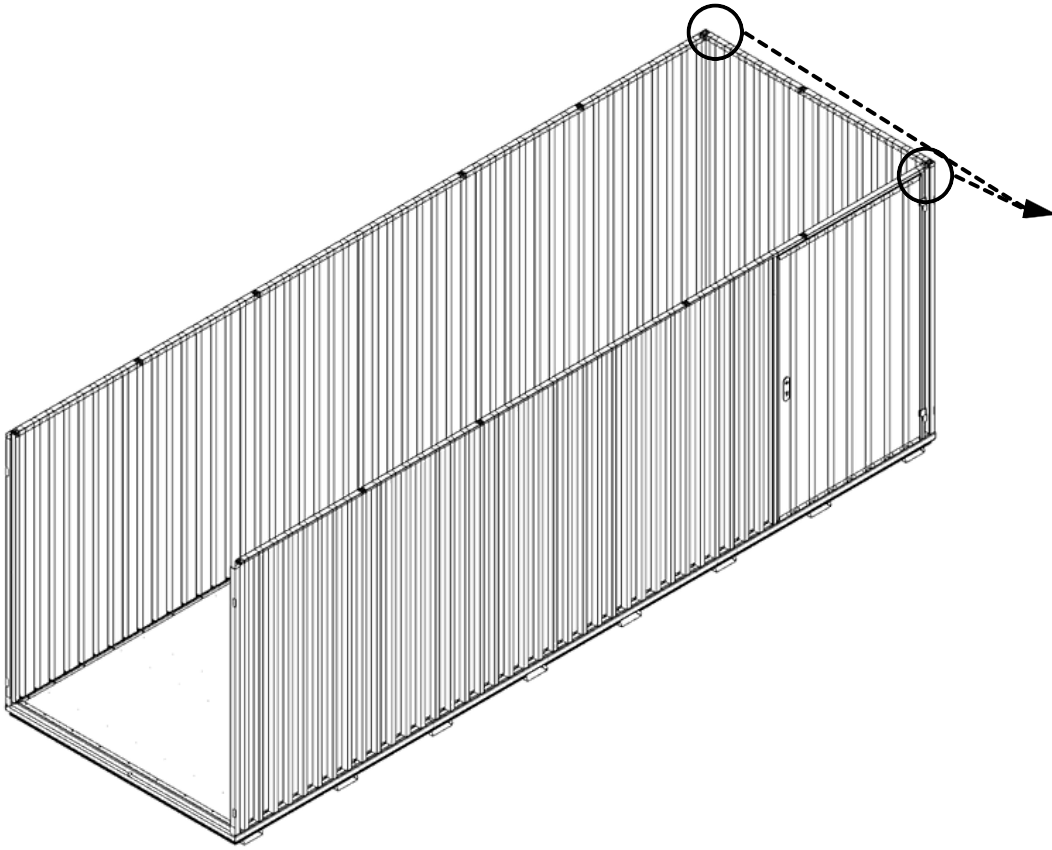



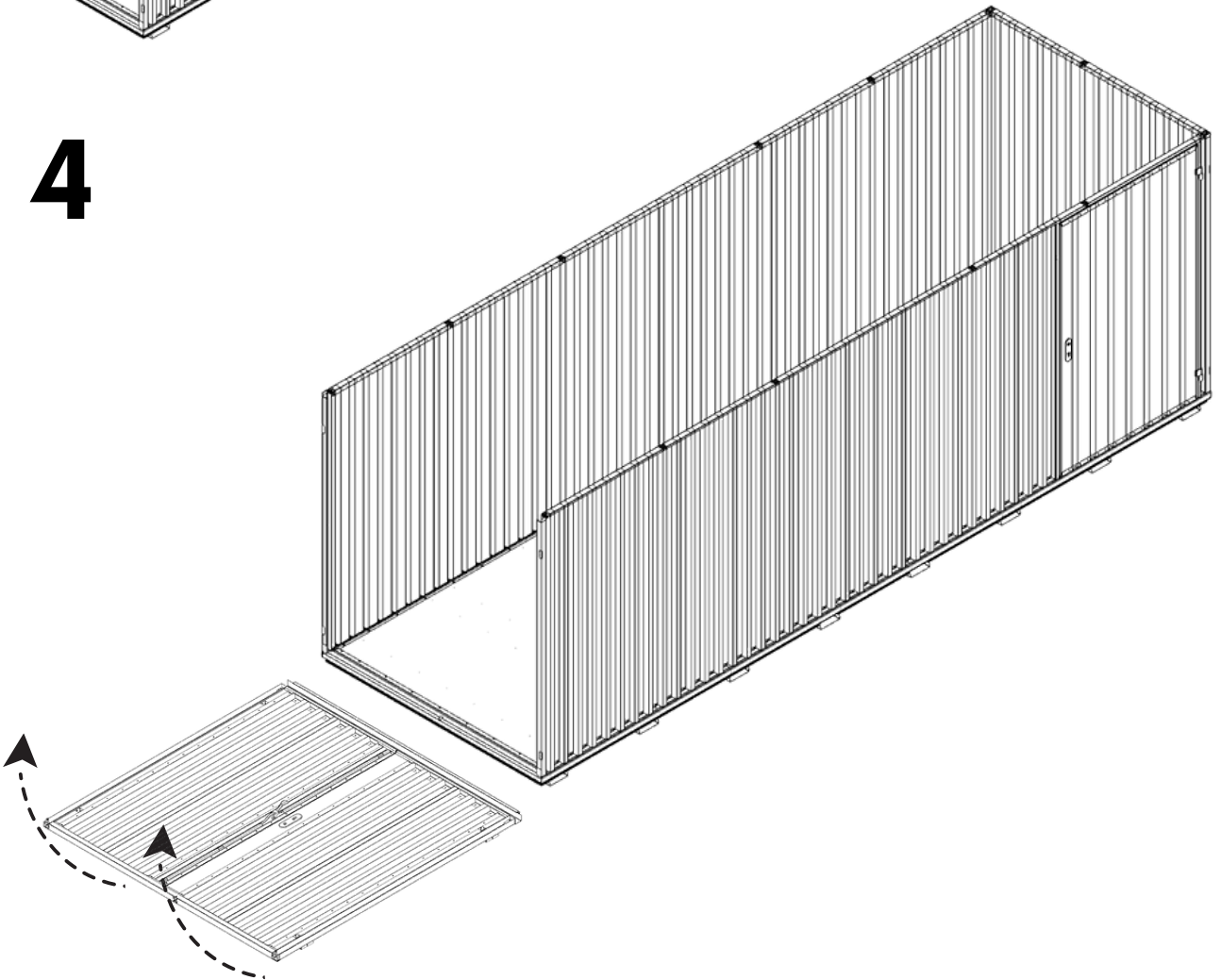



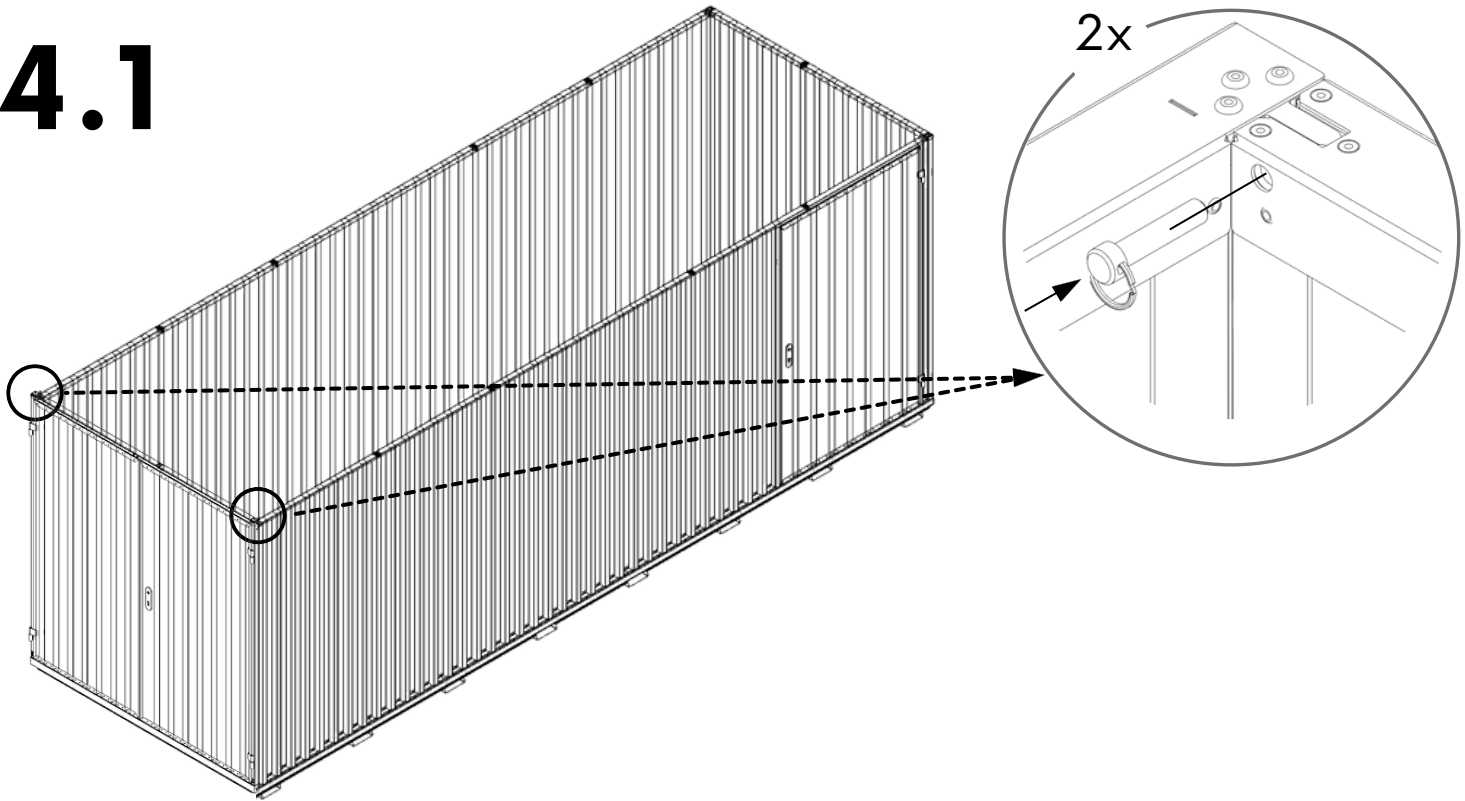

4



4.1



 601 KG	 1640 MM	Model Code: 60.110.440.330 Production Tracking Code:/X09.1.60.440.330    9001 14001 50001	 	
---	--	--	---	---

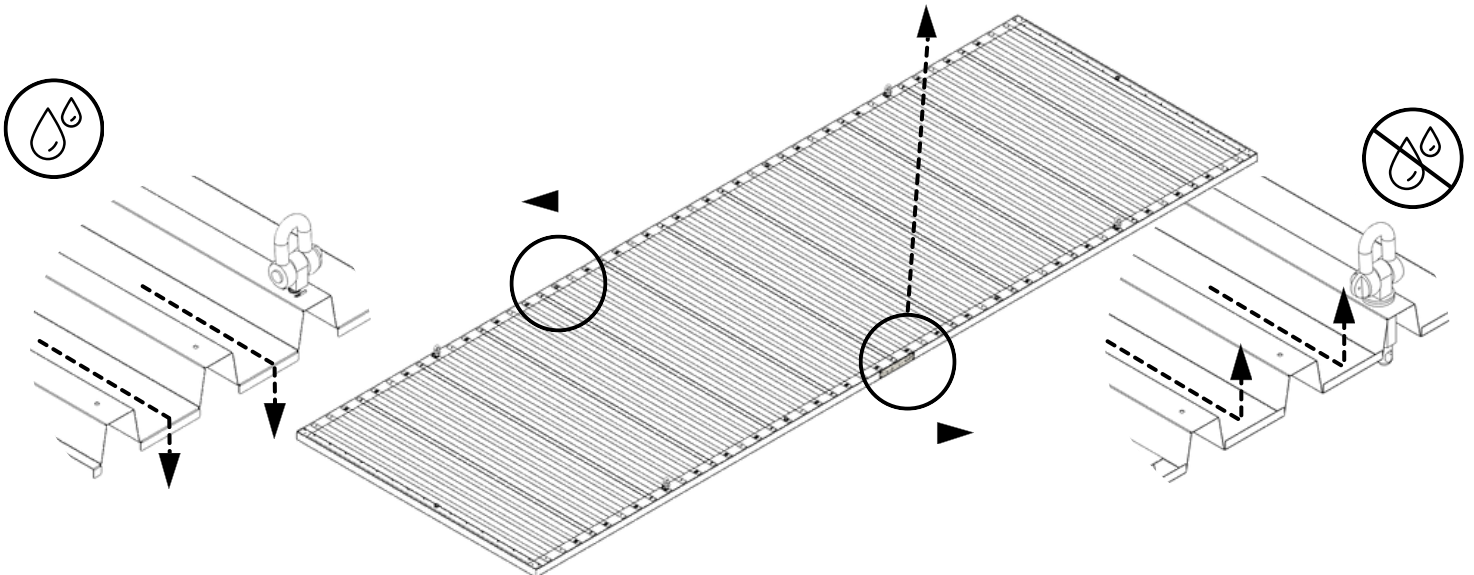

5

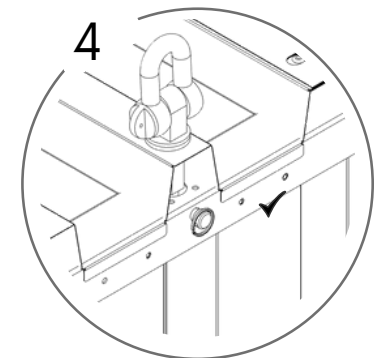
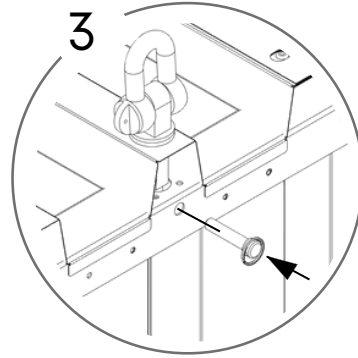
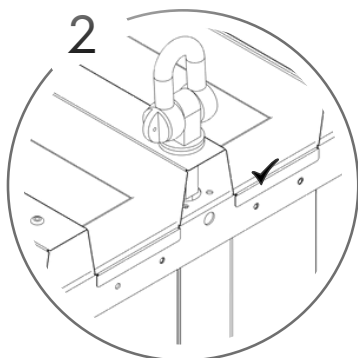
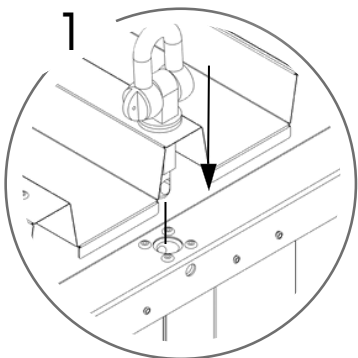
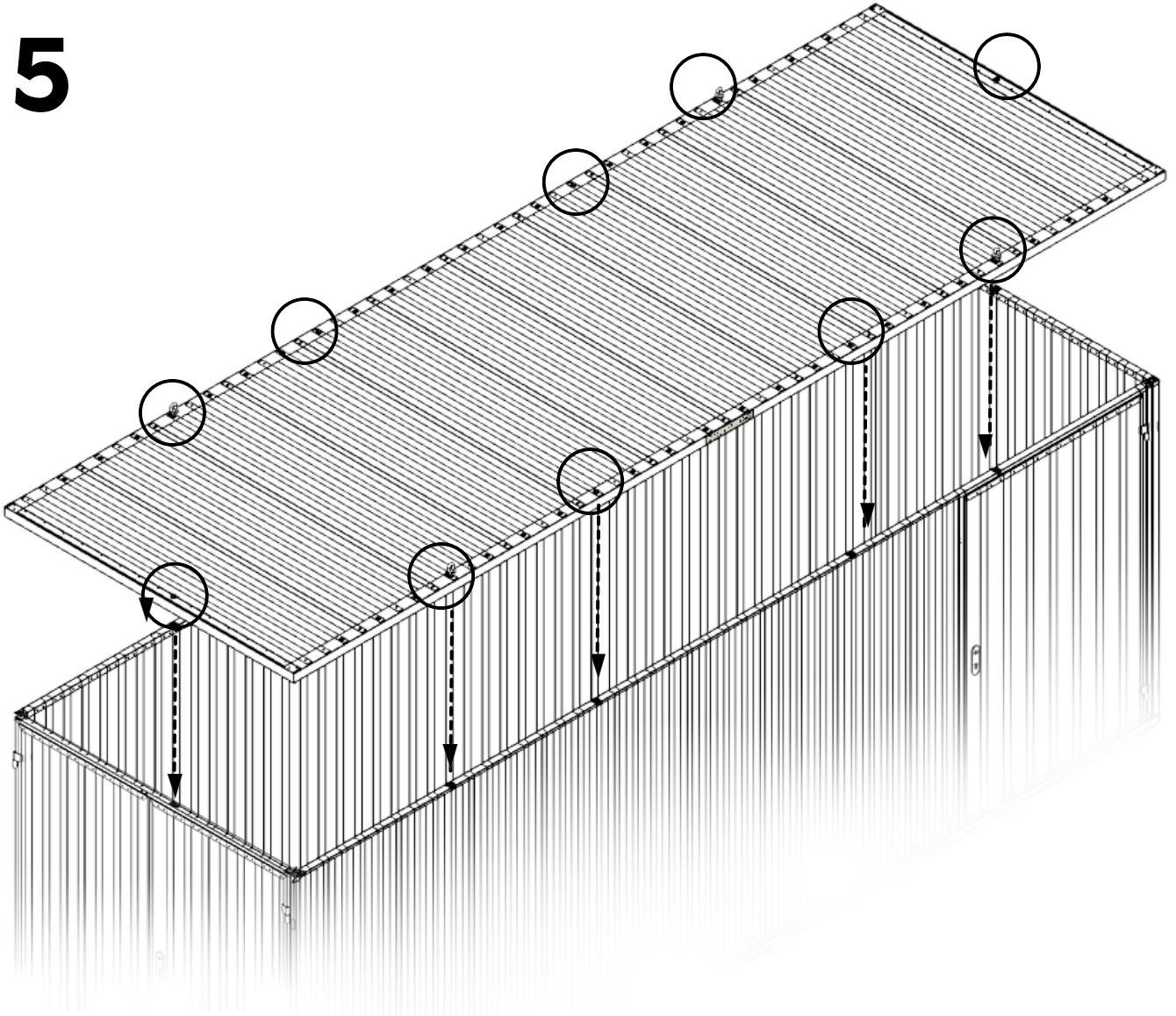

6

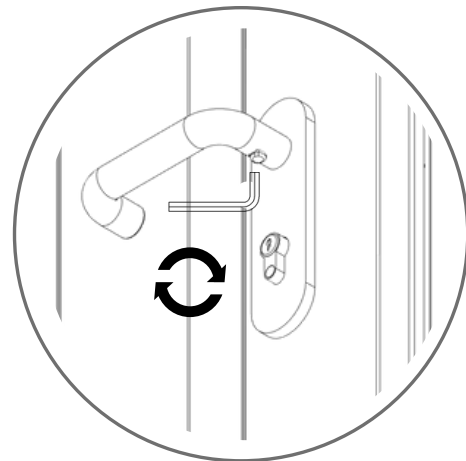
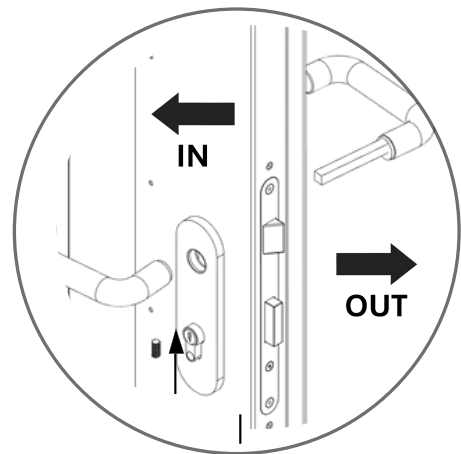
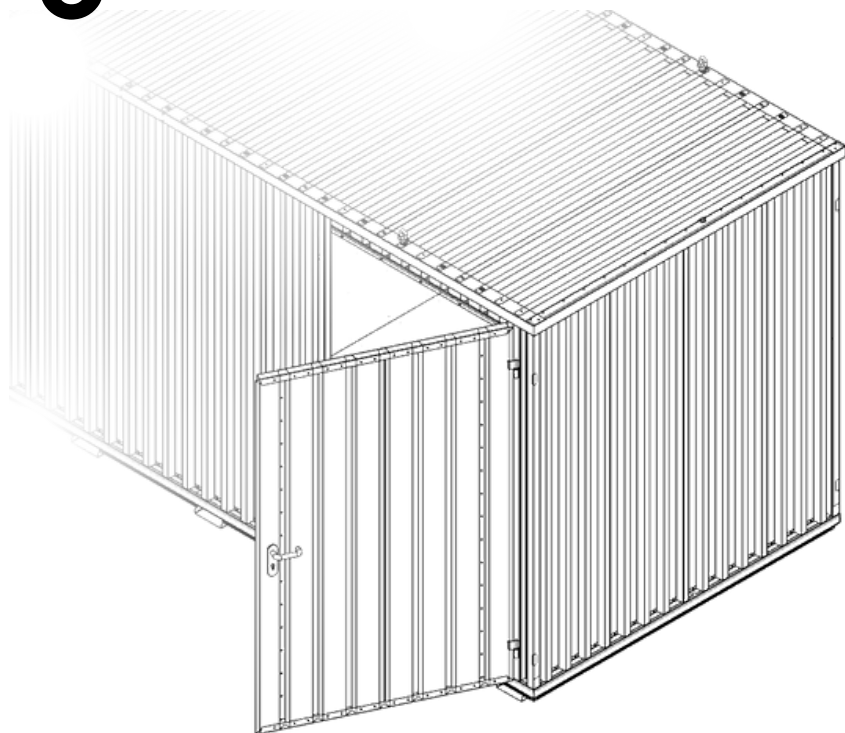

7

