

PRODUCT CODE: 30.110.430

prefabase
Quick Build Solutions

Instructions and User Guide

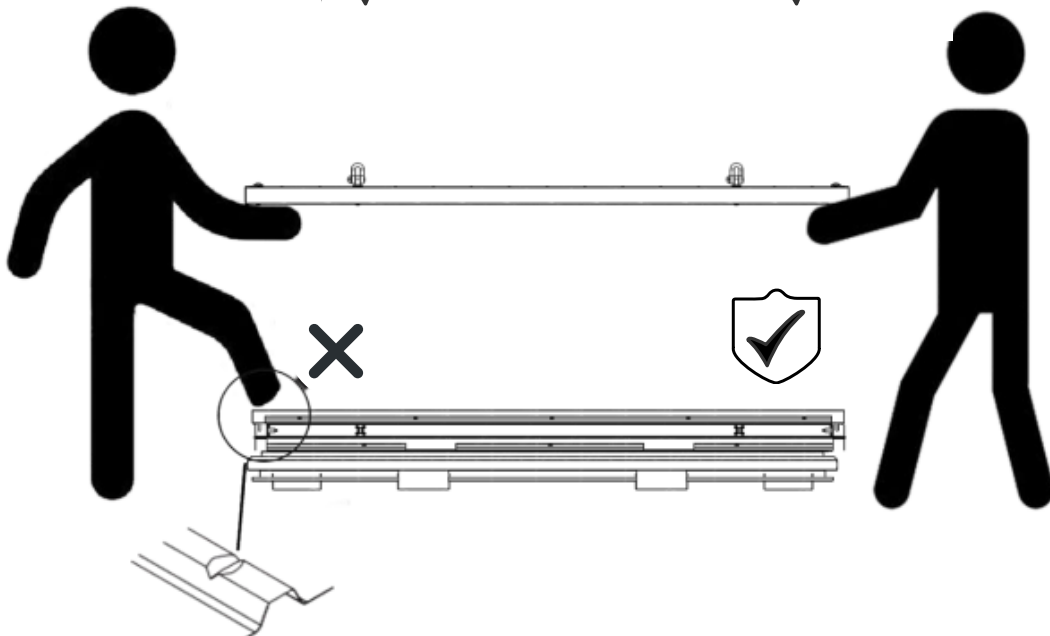
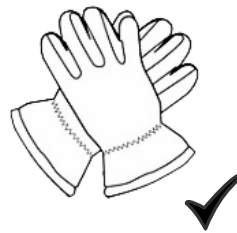

30.0110
1x

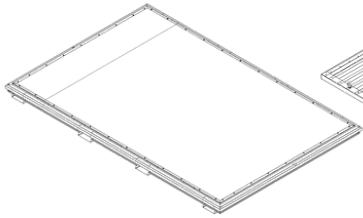

30.0510
1x

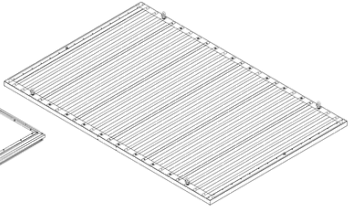

30.0410
1x

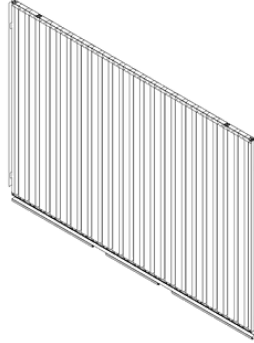

30.0430
1x

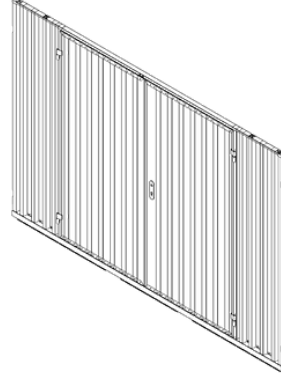

0310
2x

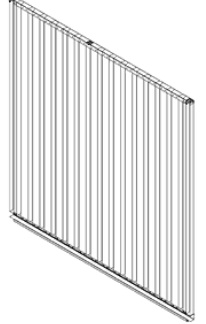

61.101
4x



10x

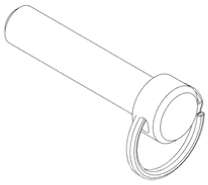

1x

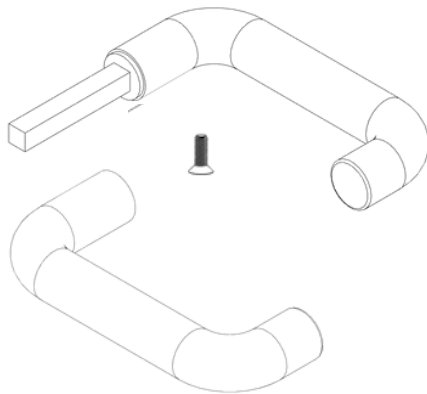

1x

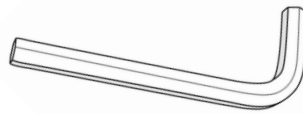

1x



1

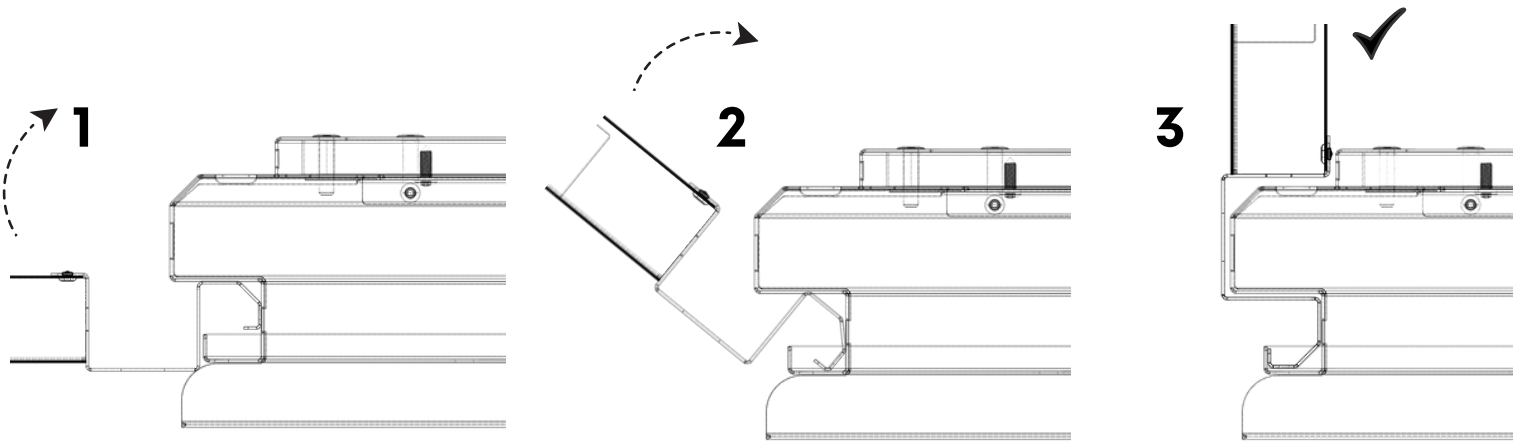
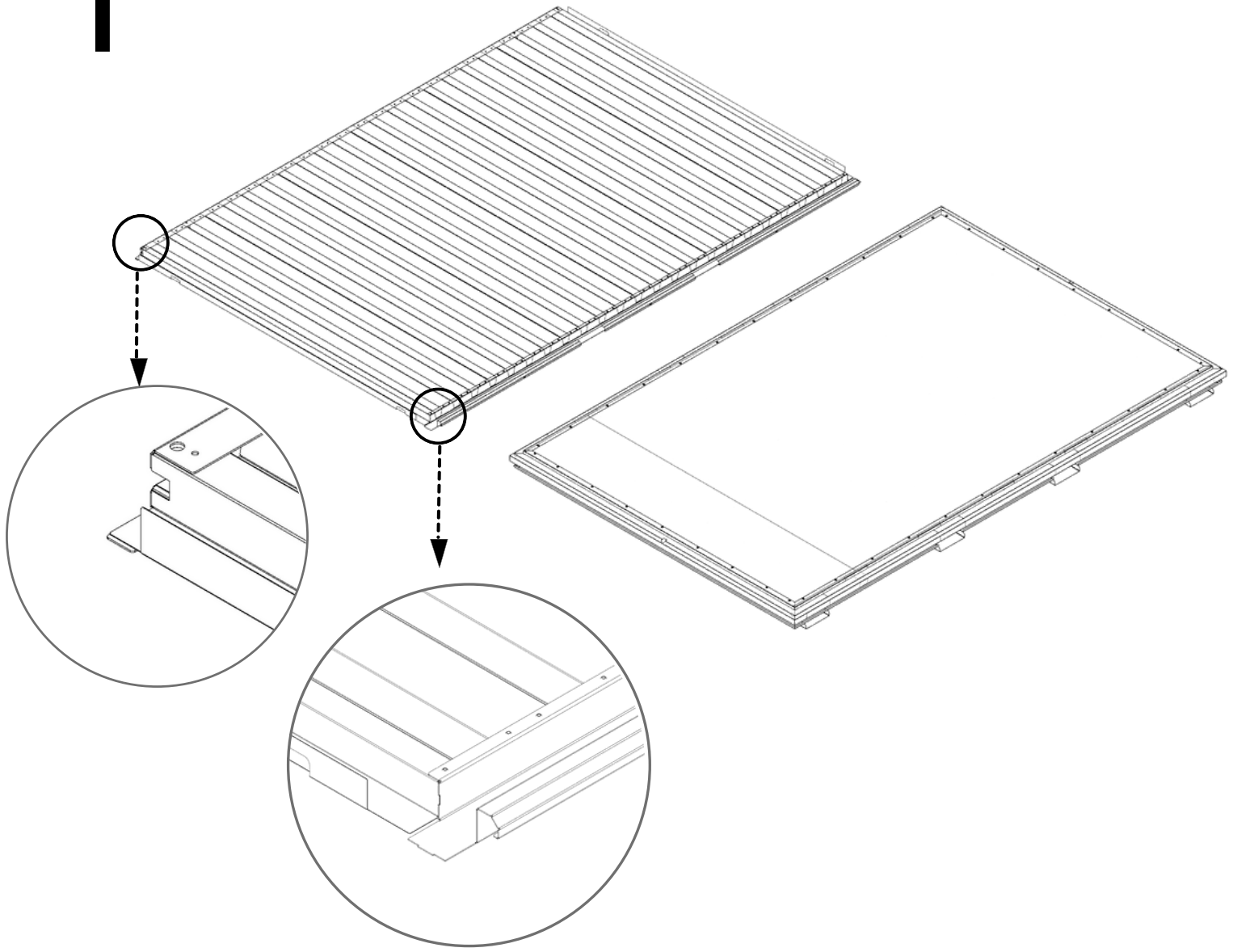

2

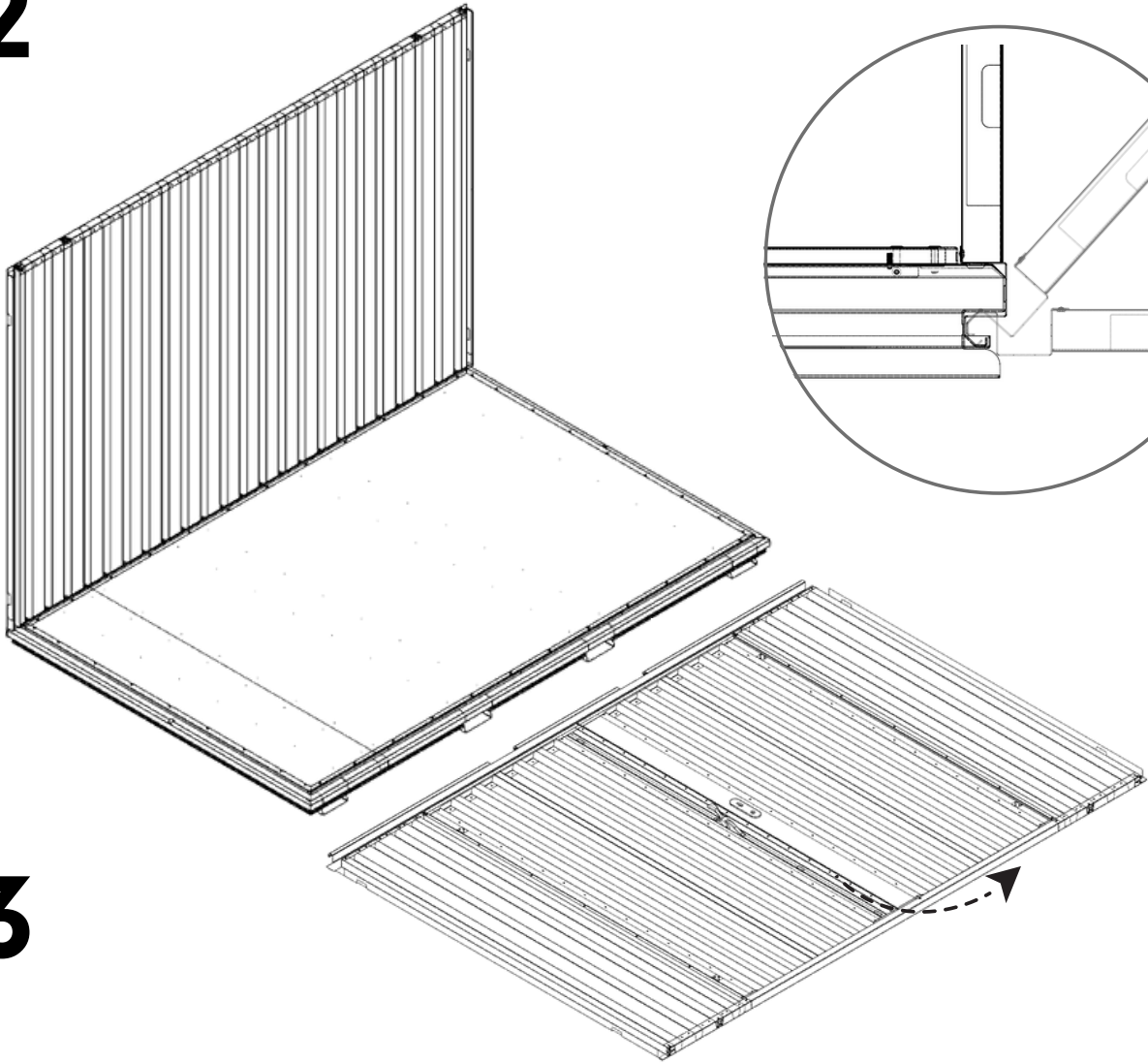

3

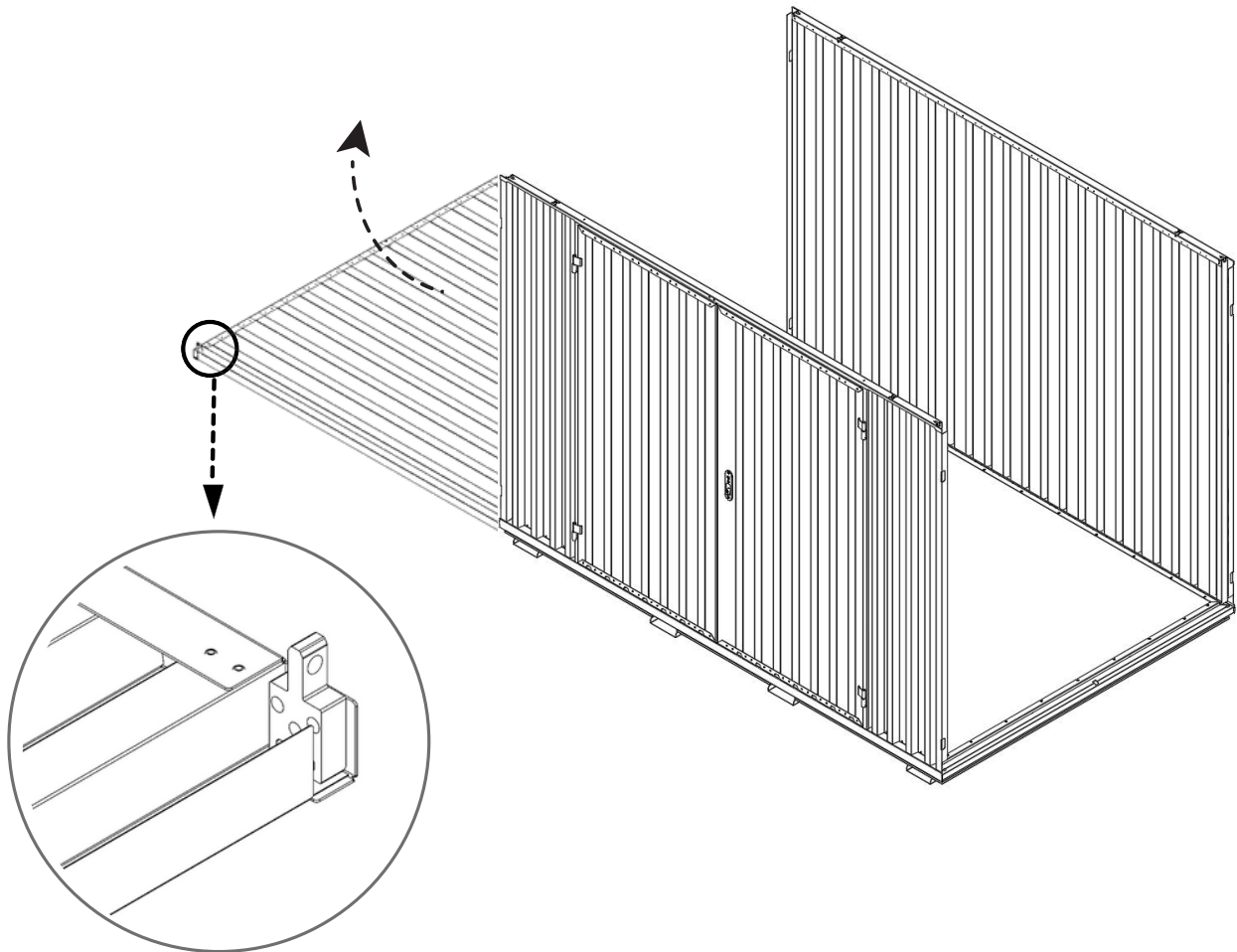

3.1

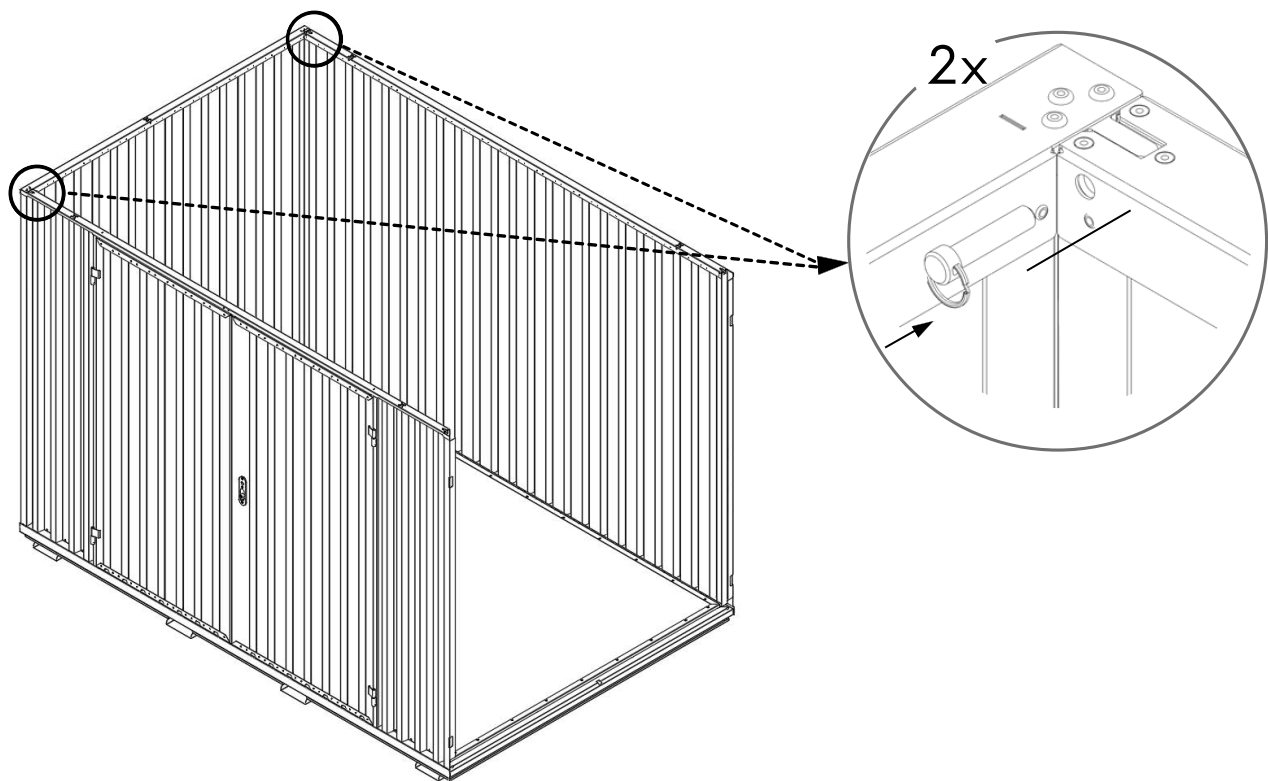



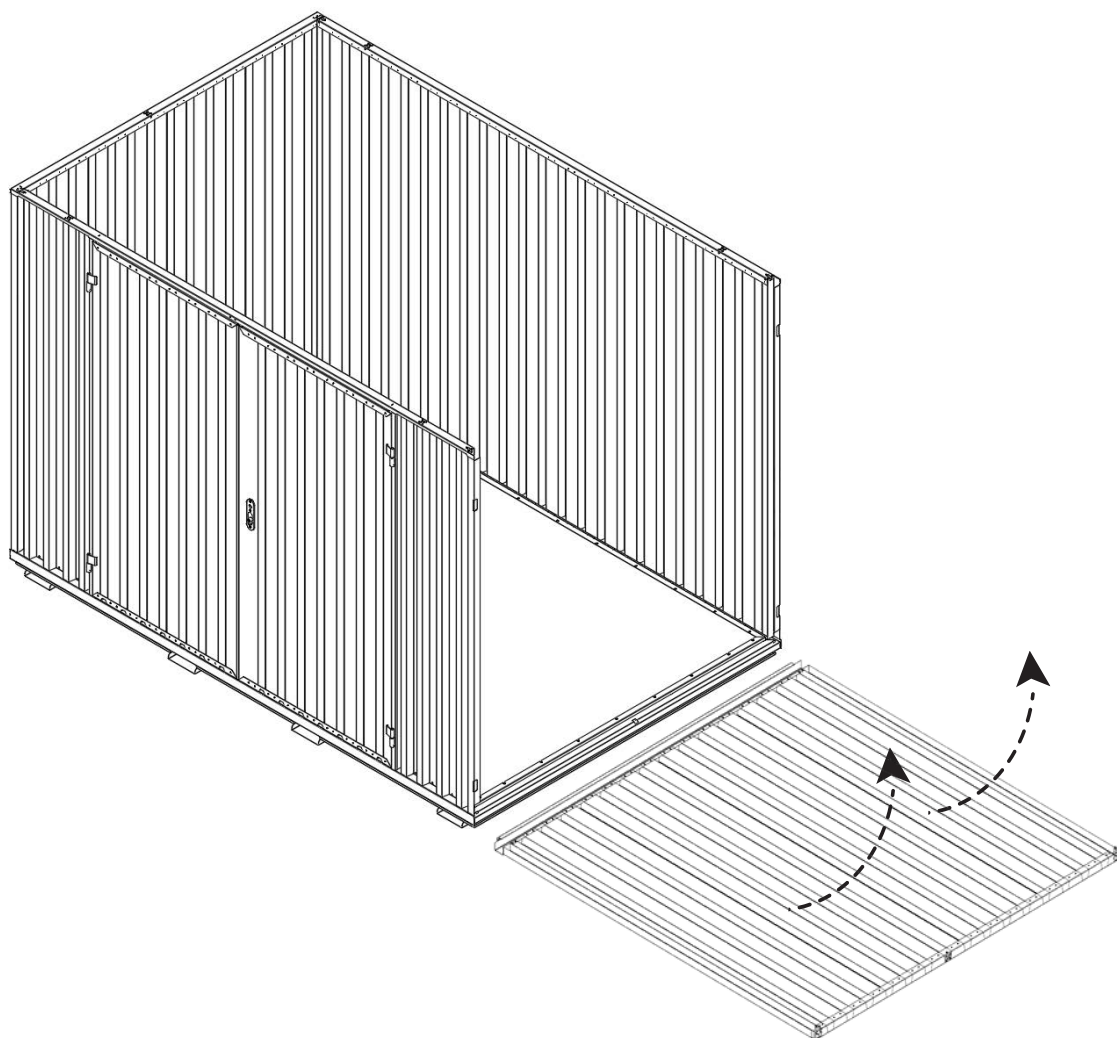



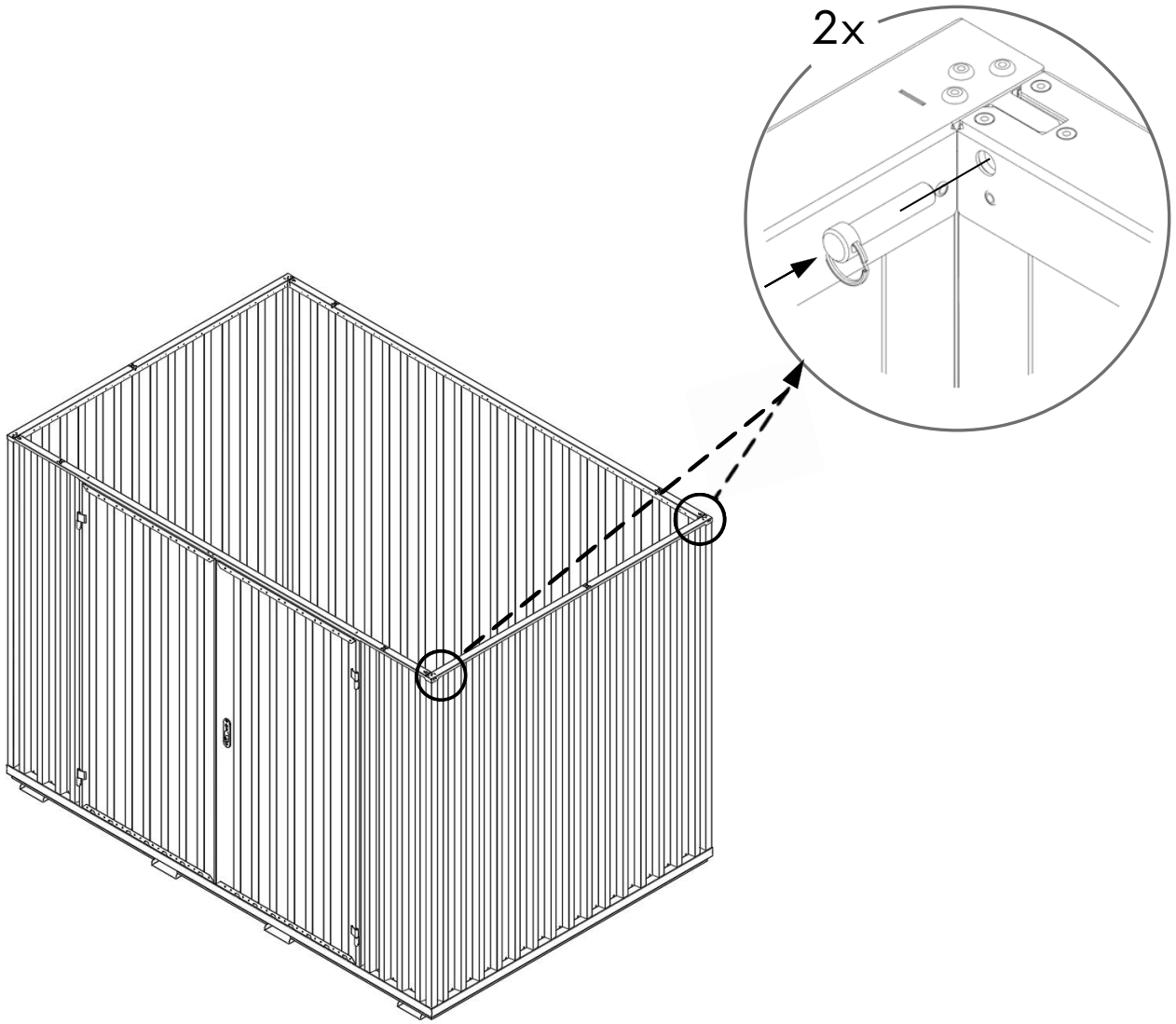

4



4.1



 346 KG	 1640 MM	Model Code: 30.110.430 Production Tracking Code:/X09.1.30.430  9001  14001  50001	 	
---	--	---	---	---

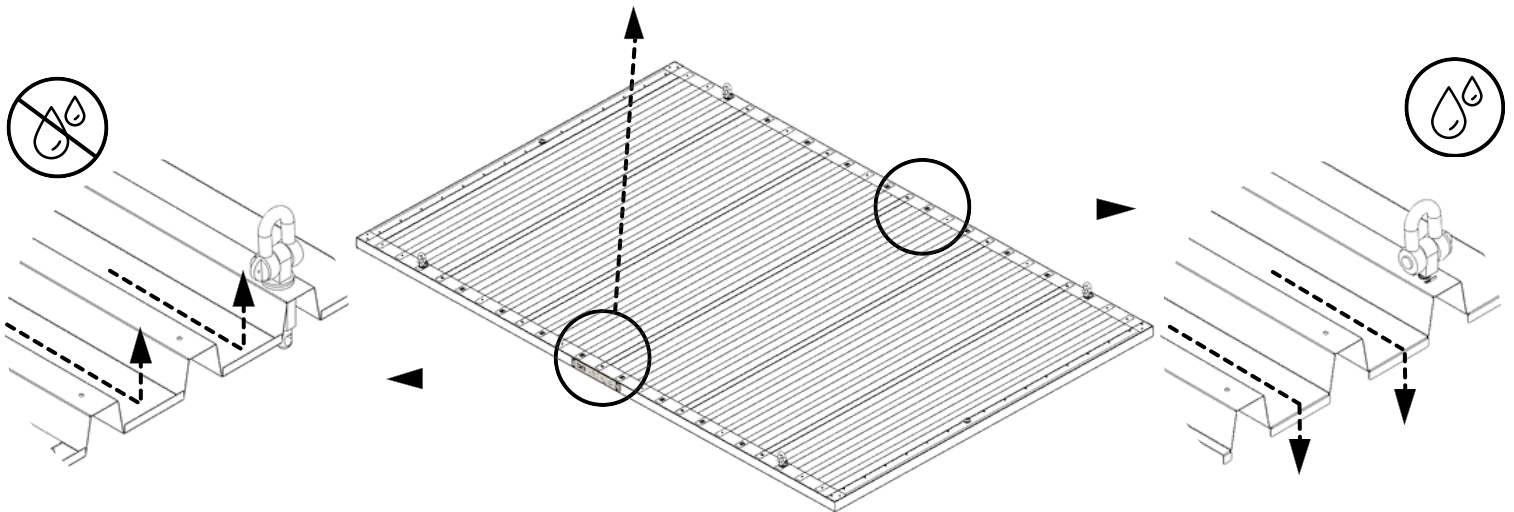

5

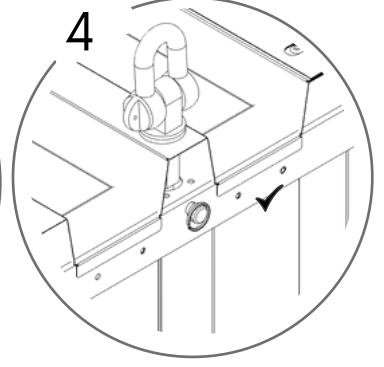
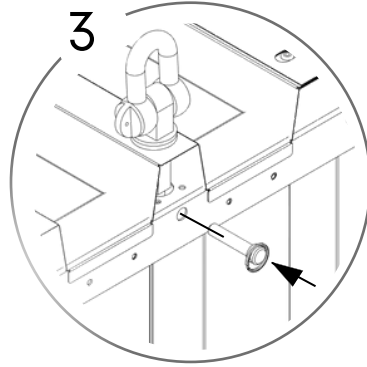
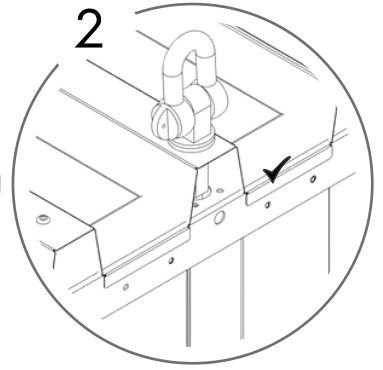
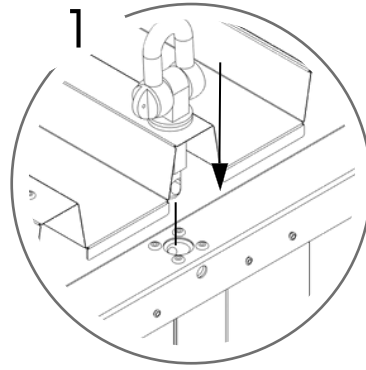
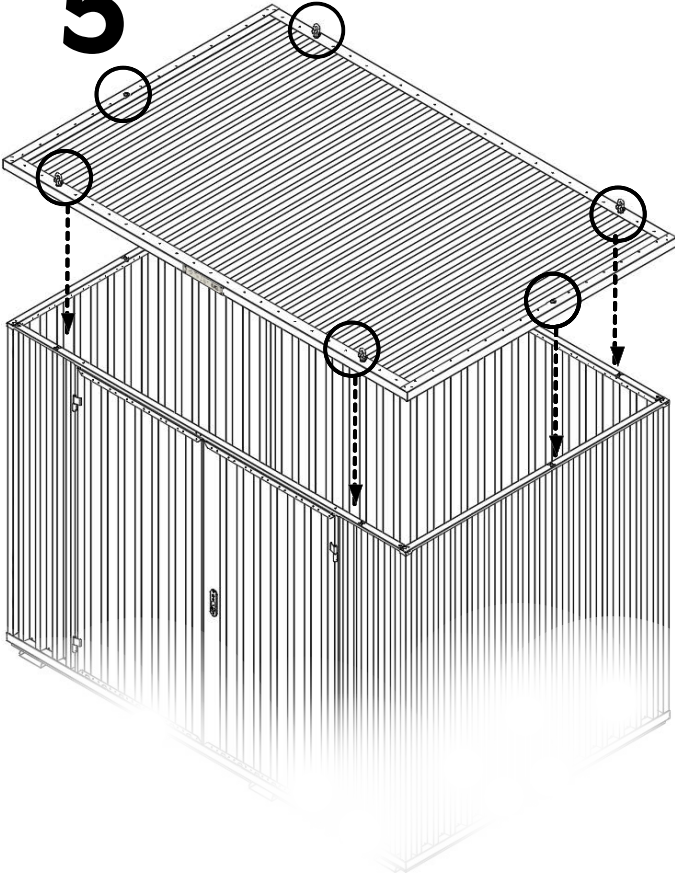

6

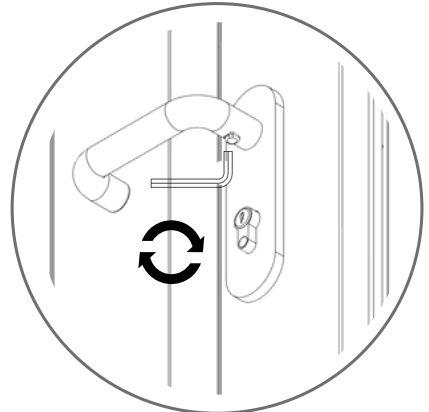
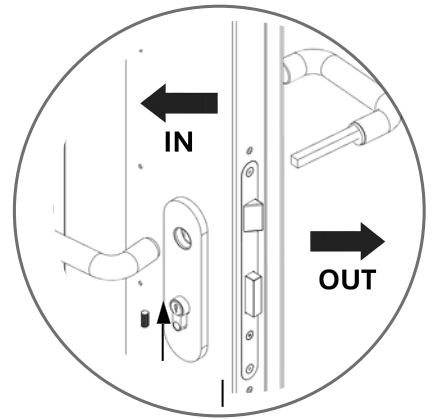
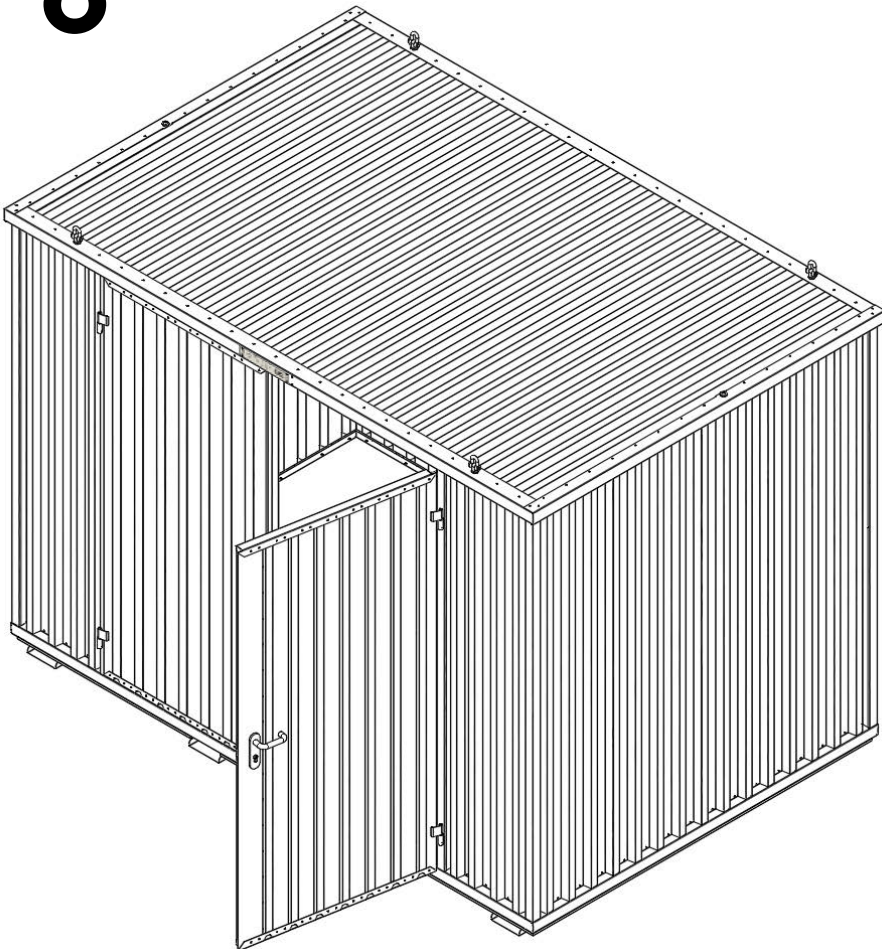

7

