







PRODUCT CODE :5055.110.450



	36 pcs.
	1 pcs.
	1 pcs.
	20 pcs.
	20 pcs.
	20 pcs.

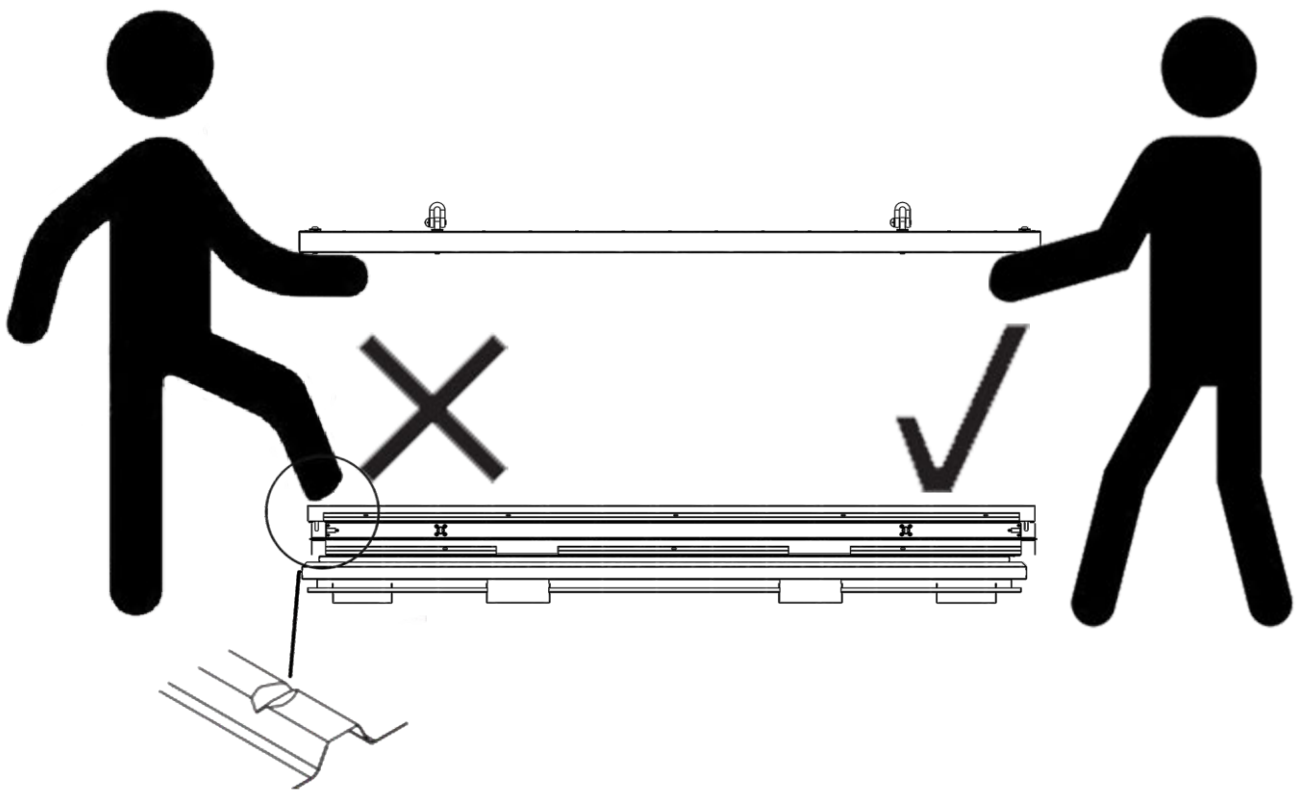
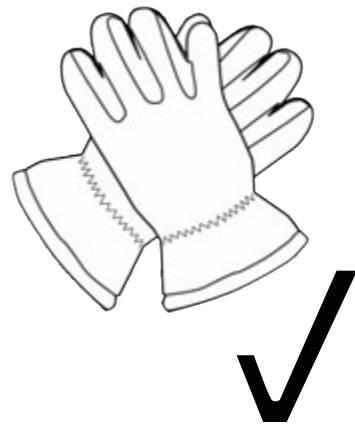

1.1.

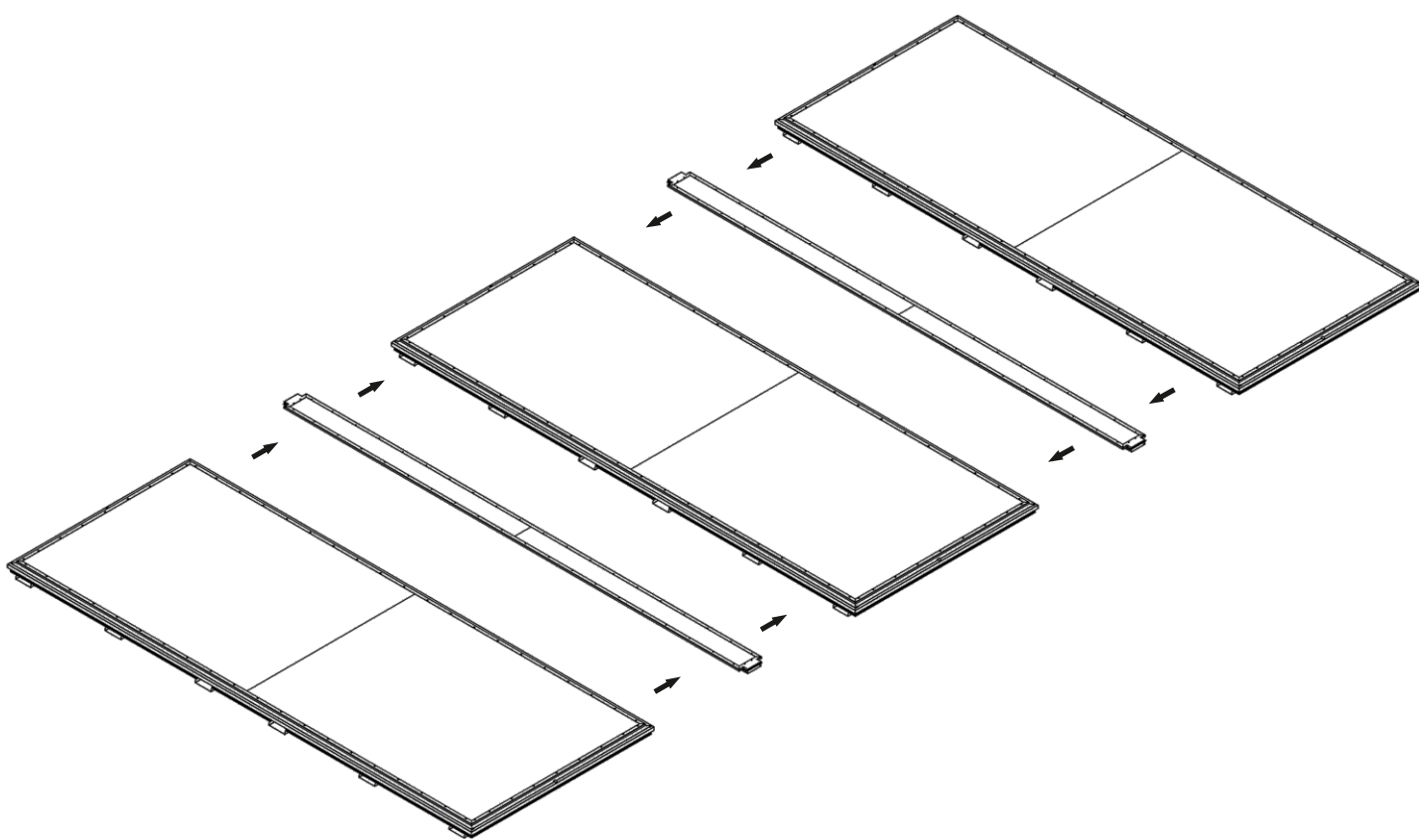

1.2.

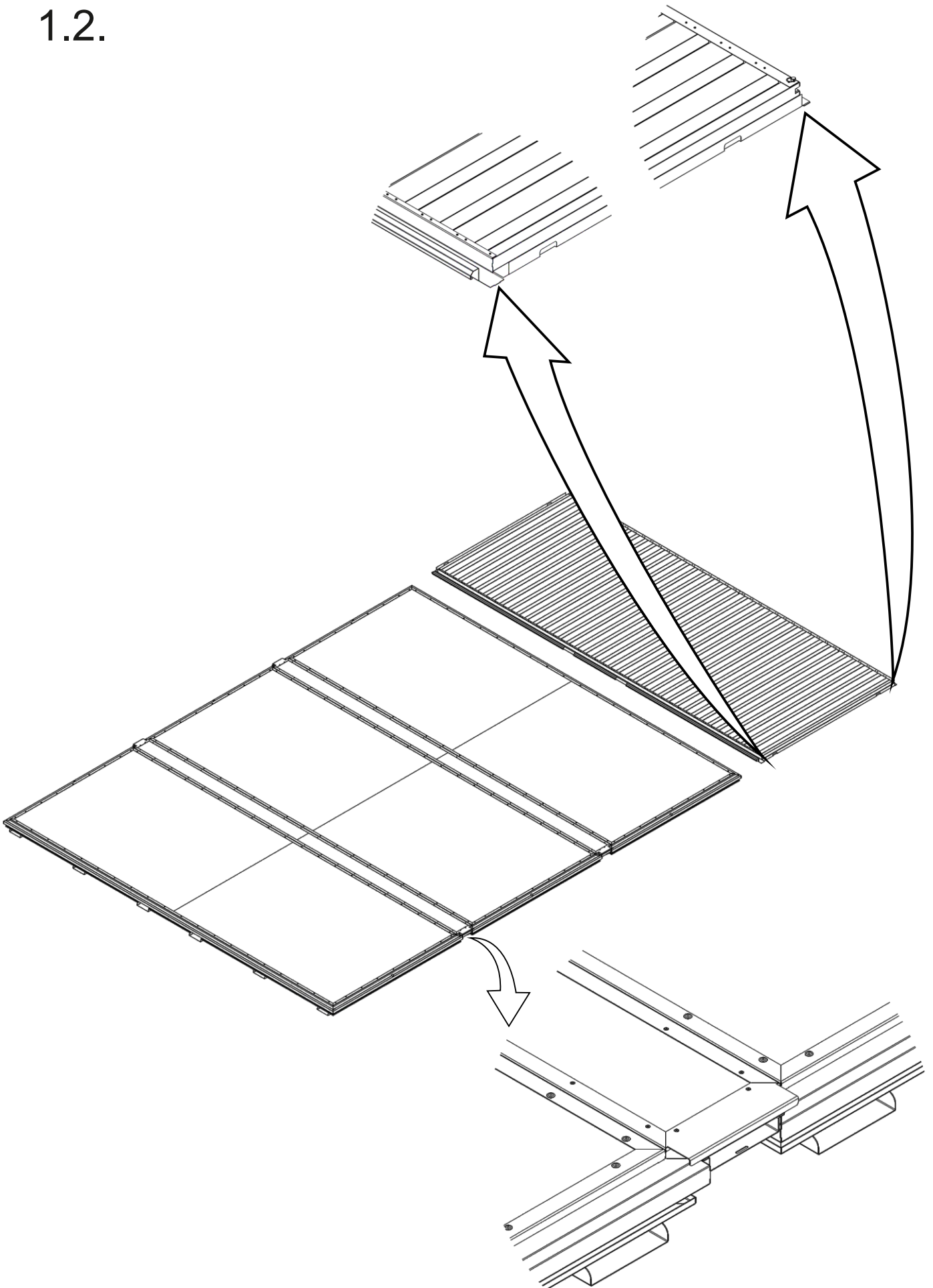

2.1.

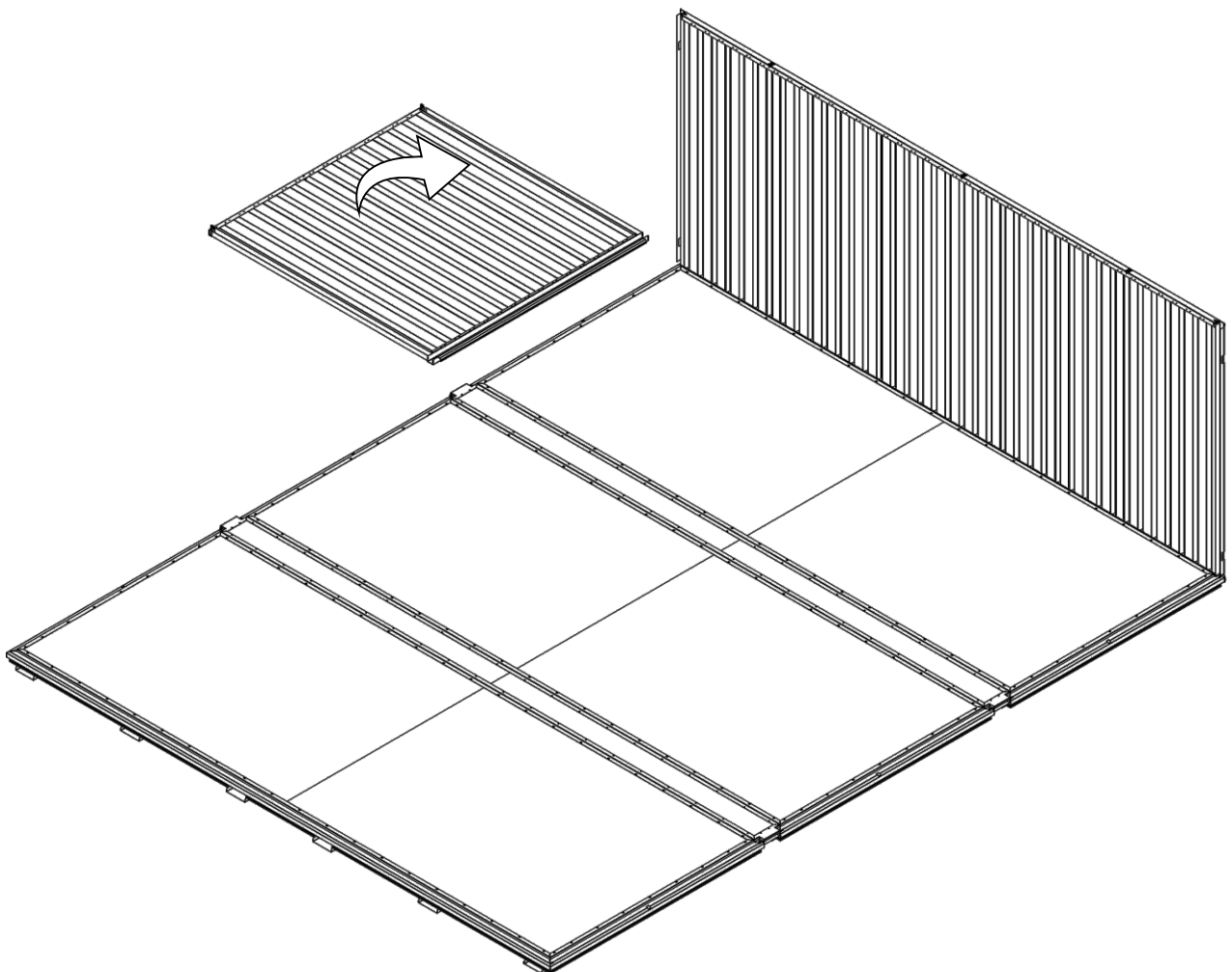
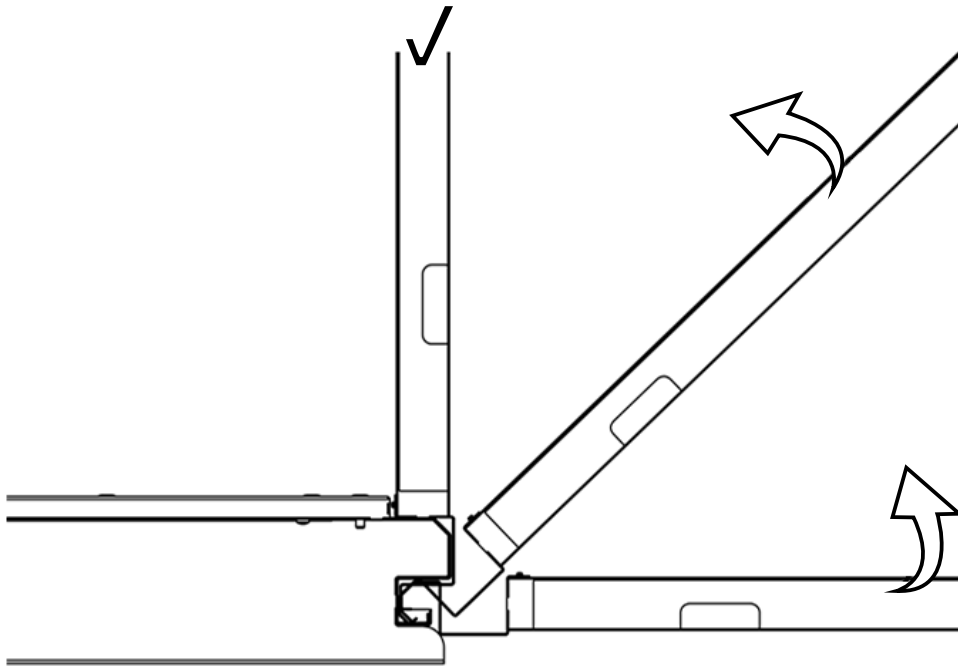

3.1.

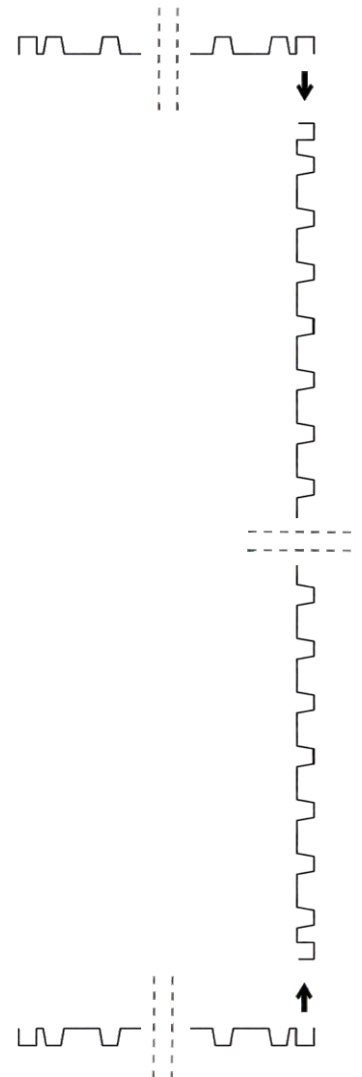
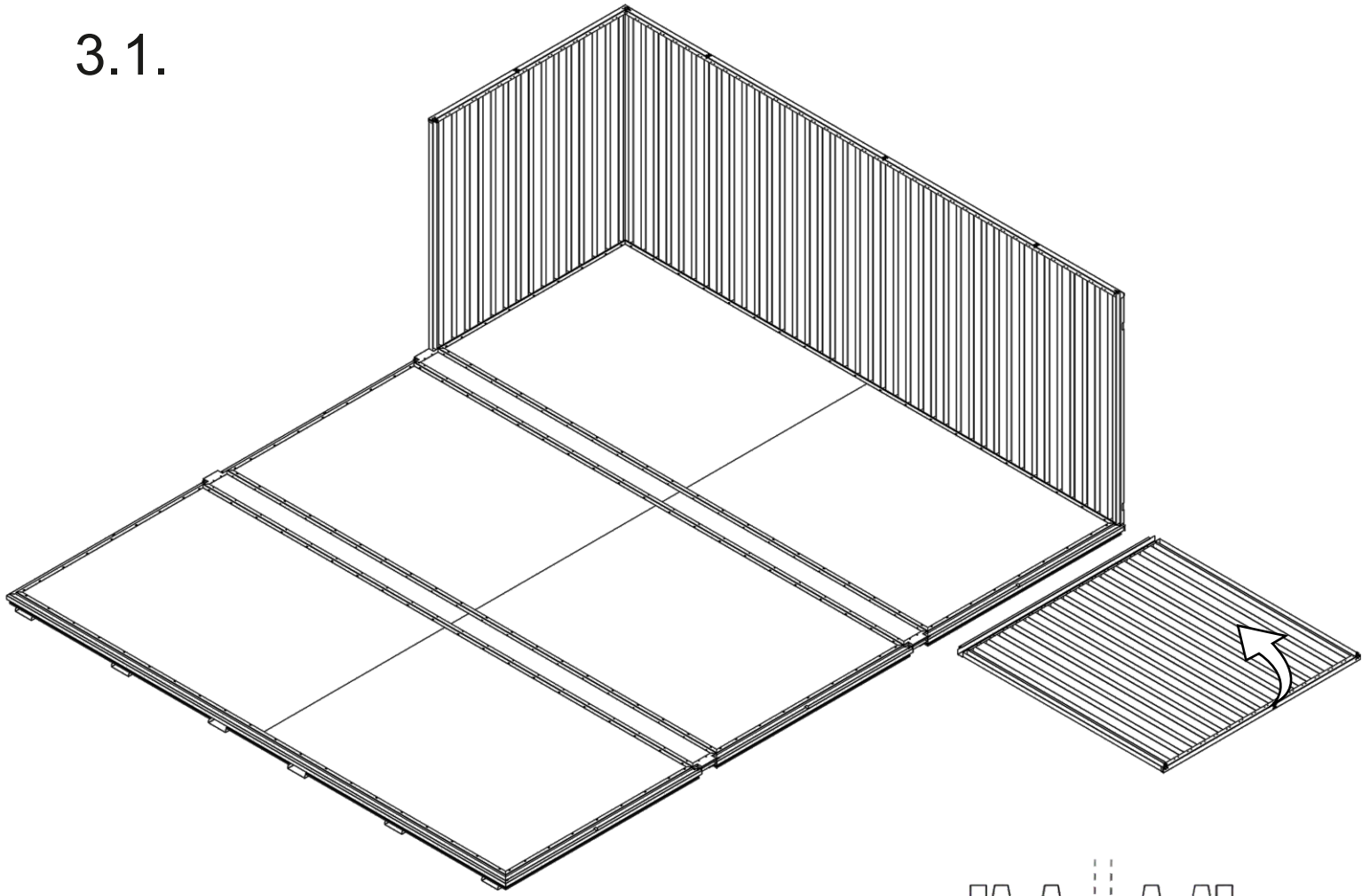

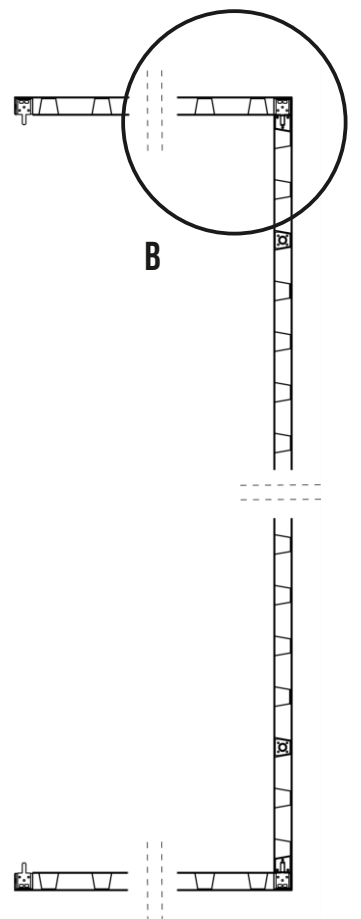
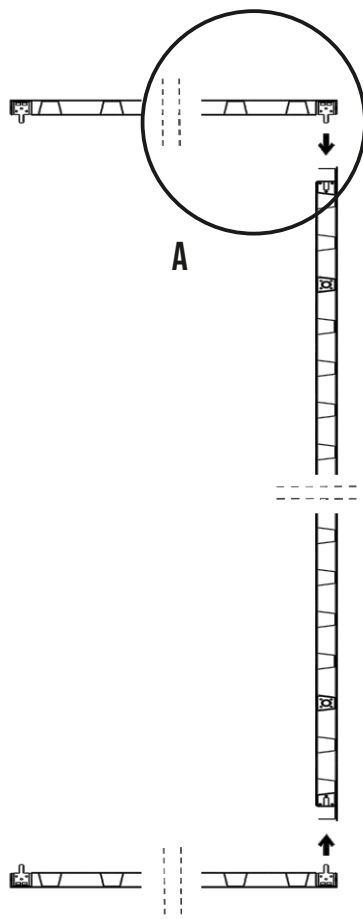
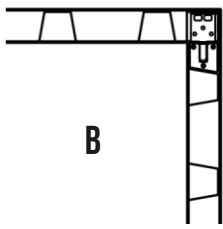
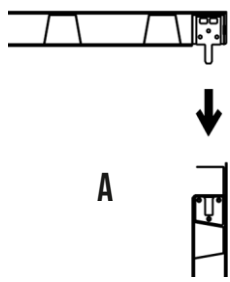

3.2.

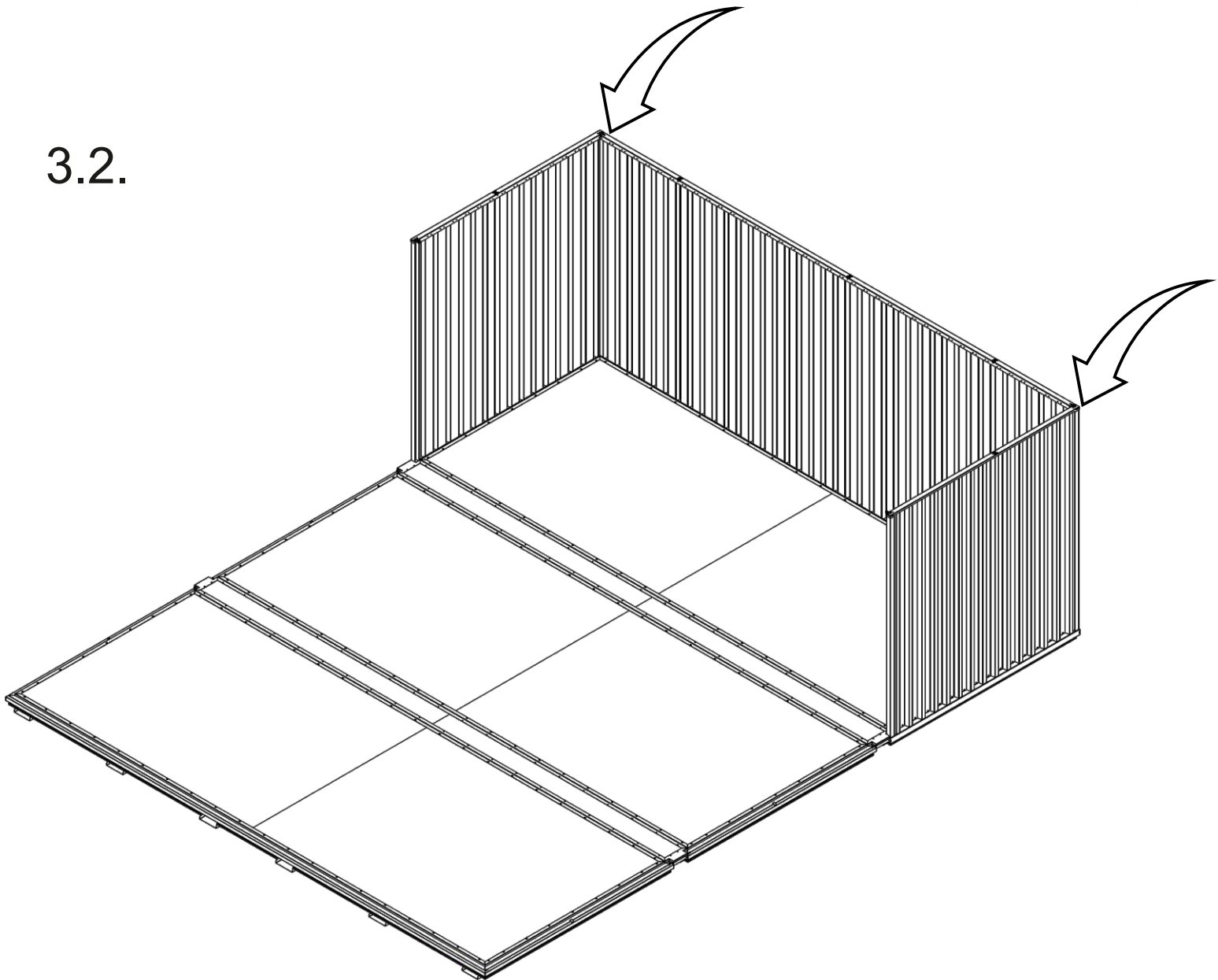

3.3.

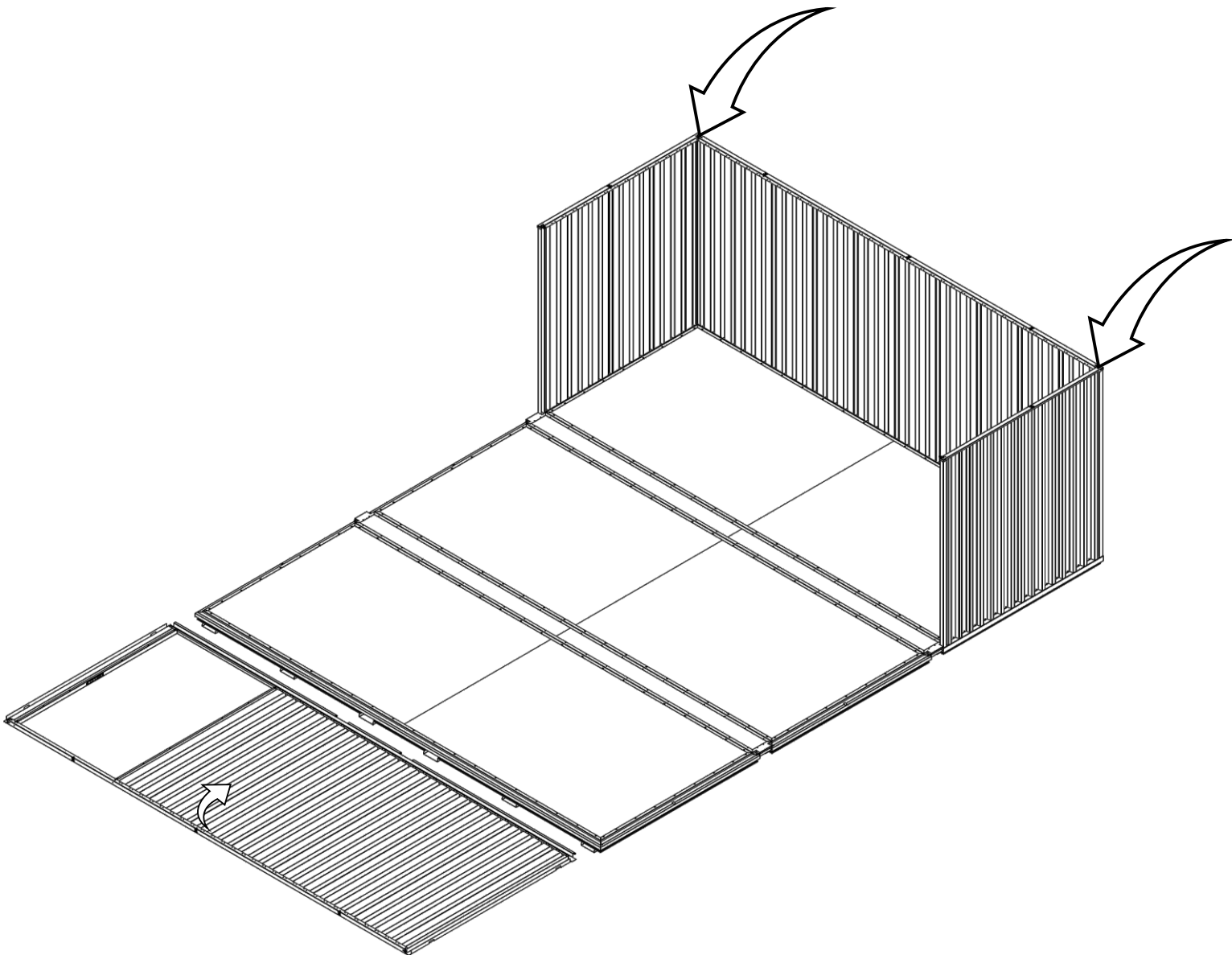
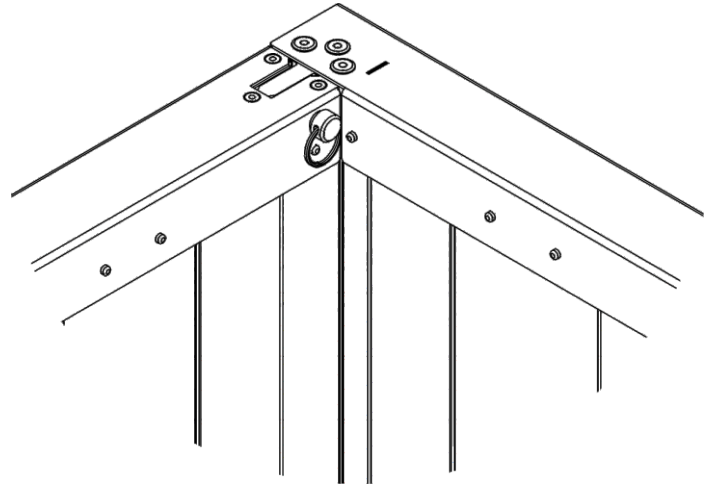
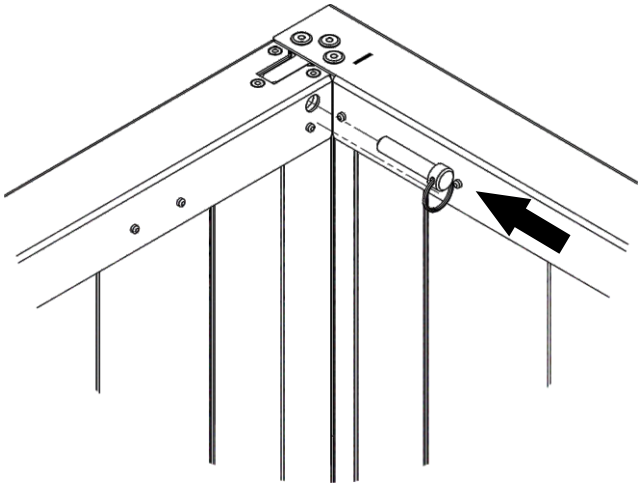

4.1.

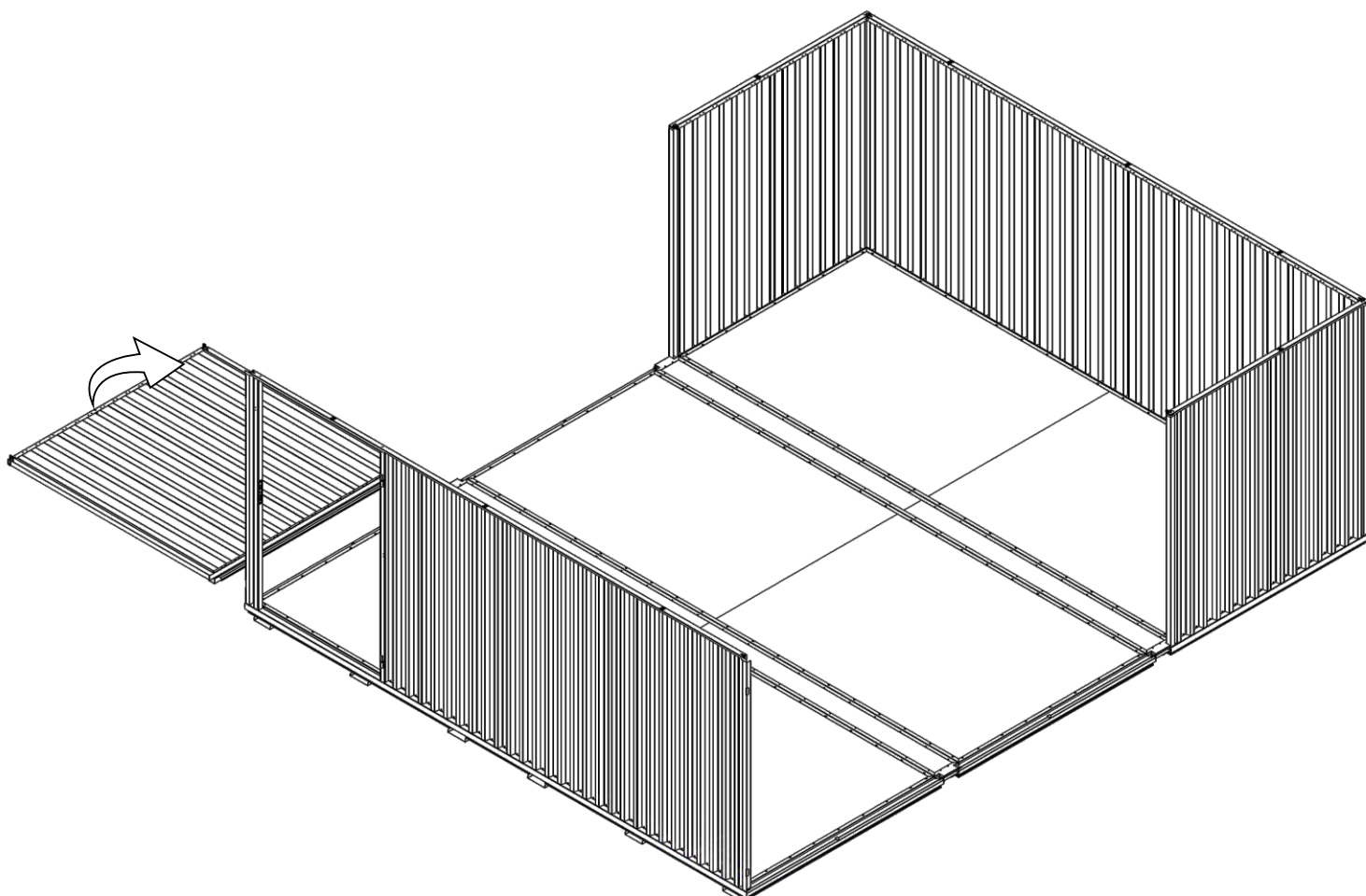
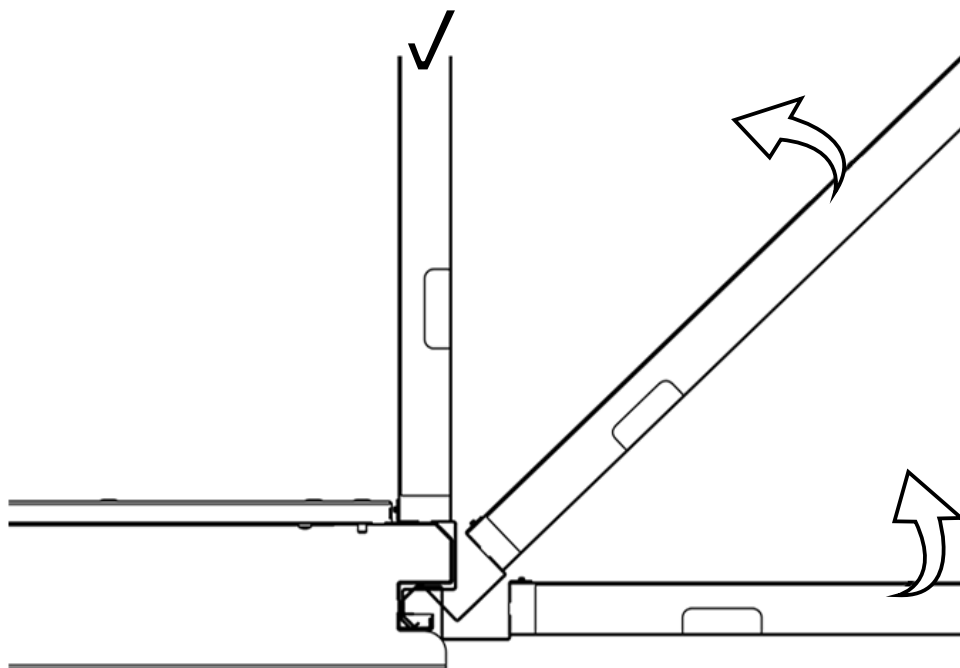

5.1.

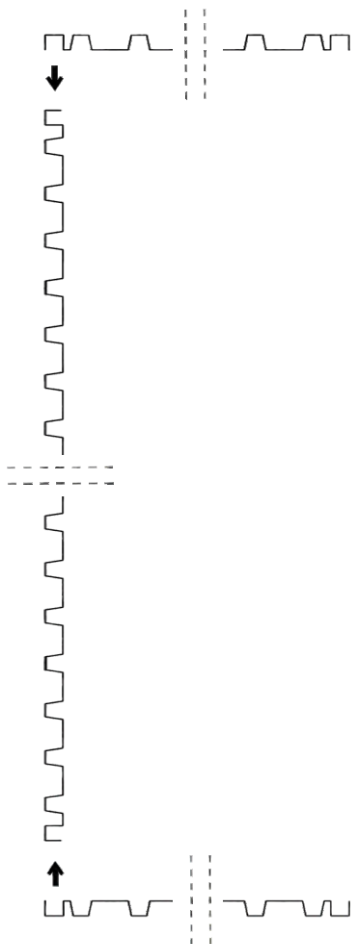
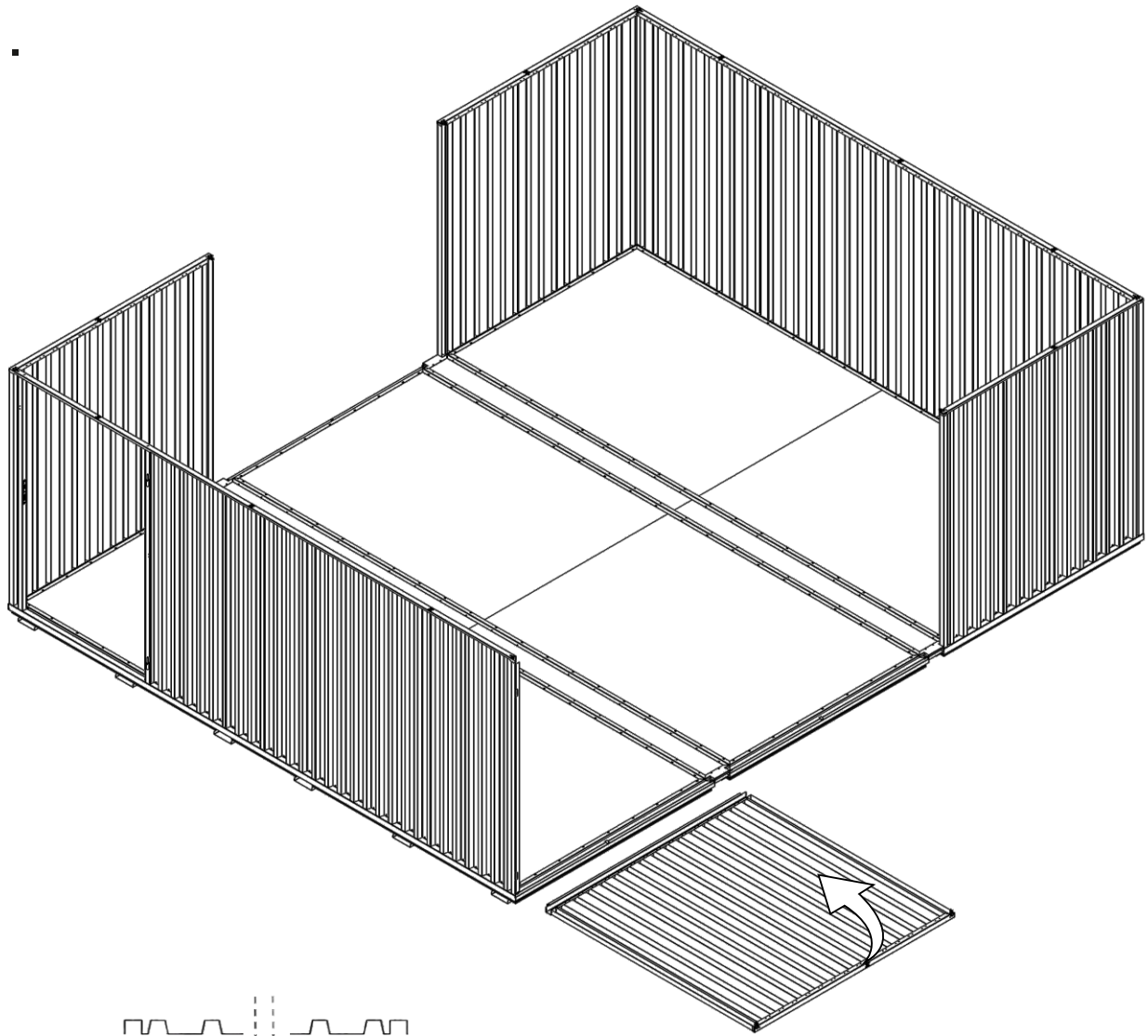

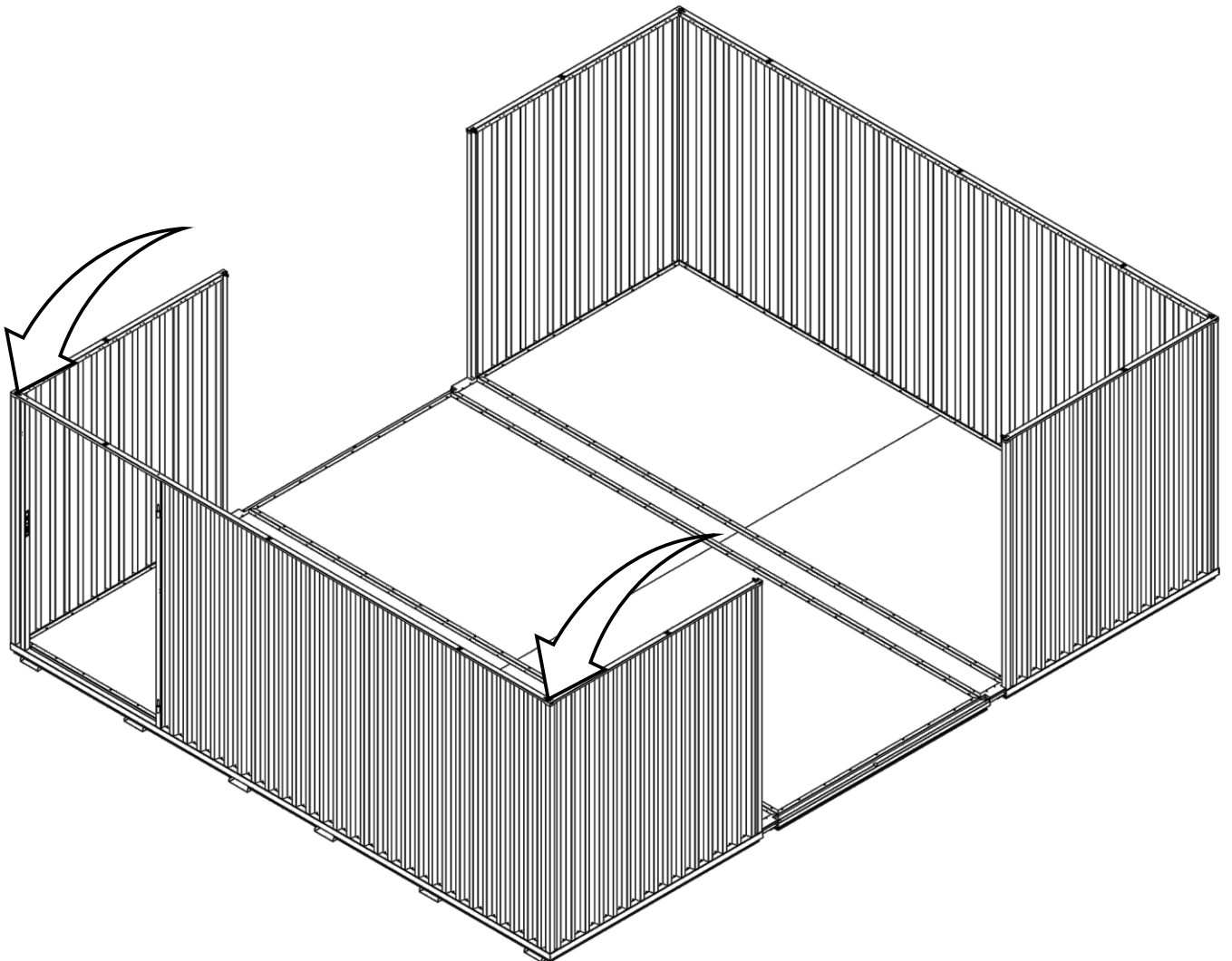
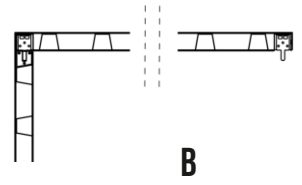
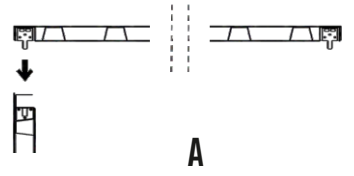
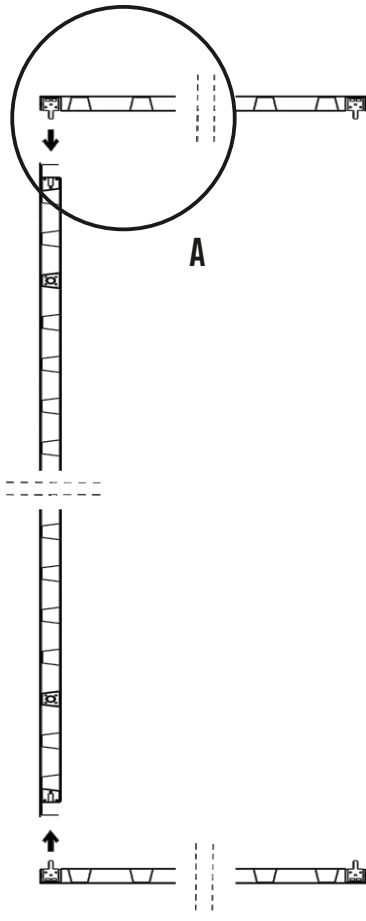
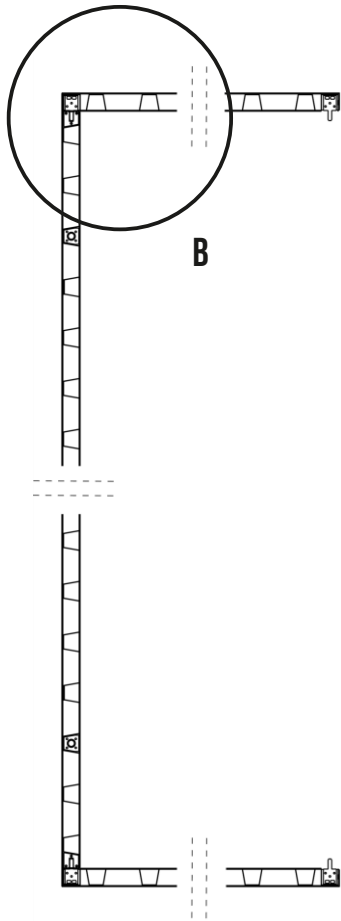

5.2.

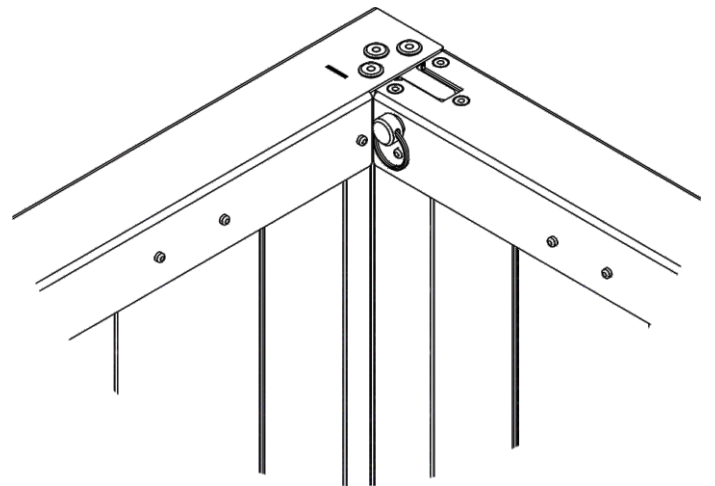
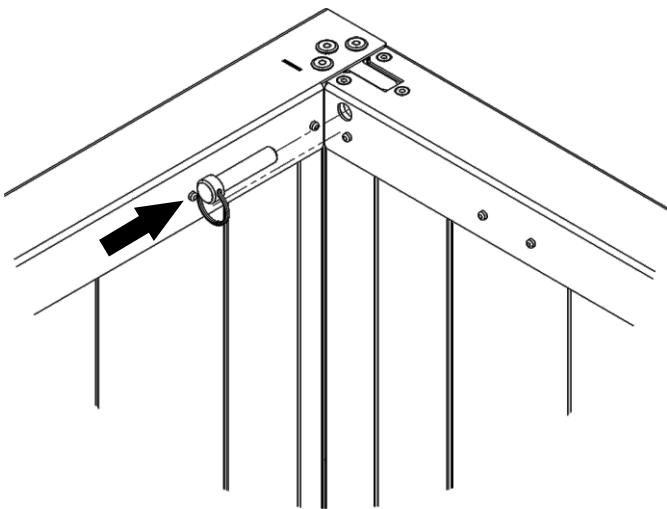
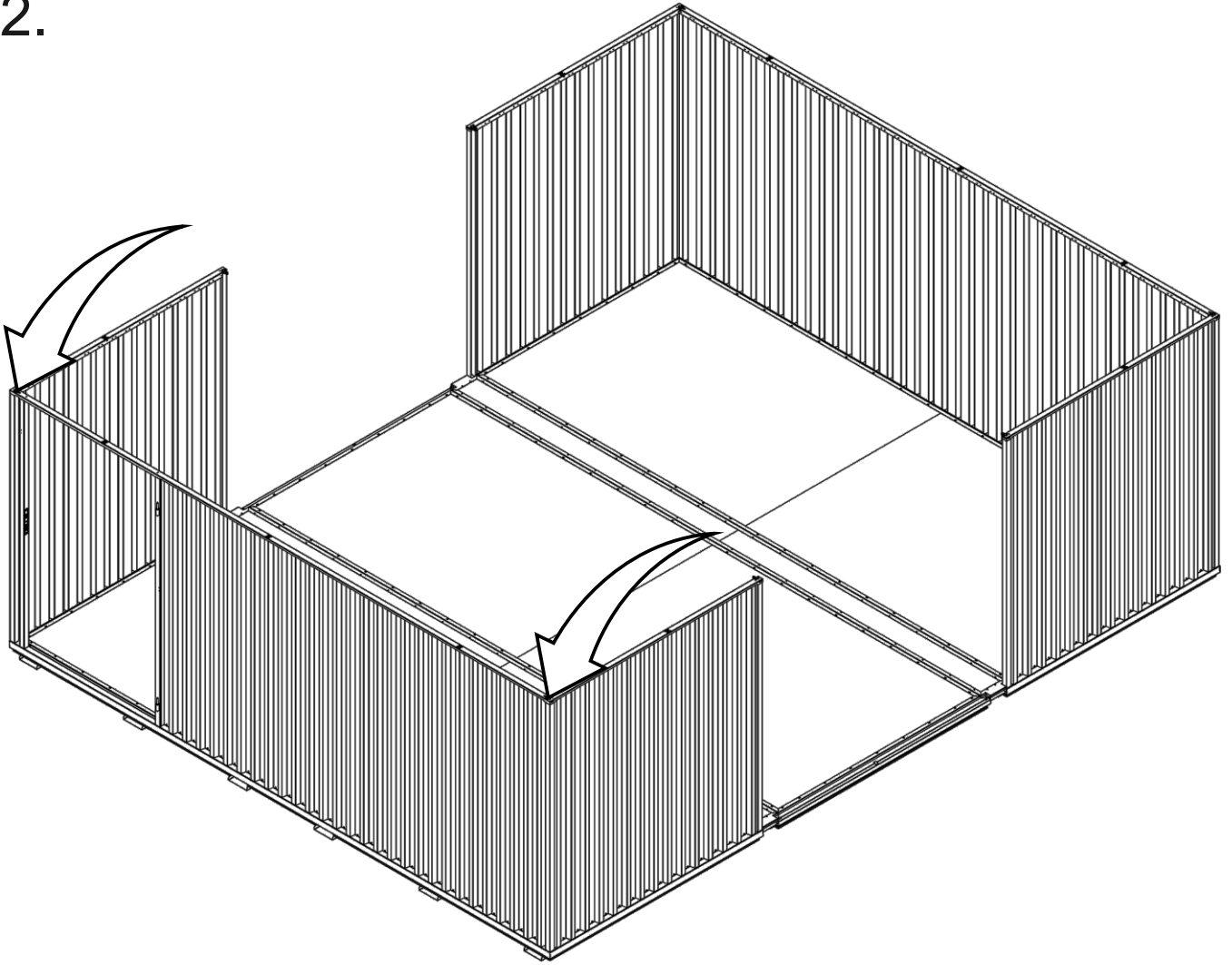

6.1.

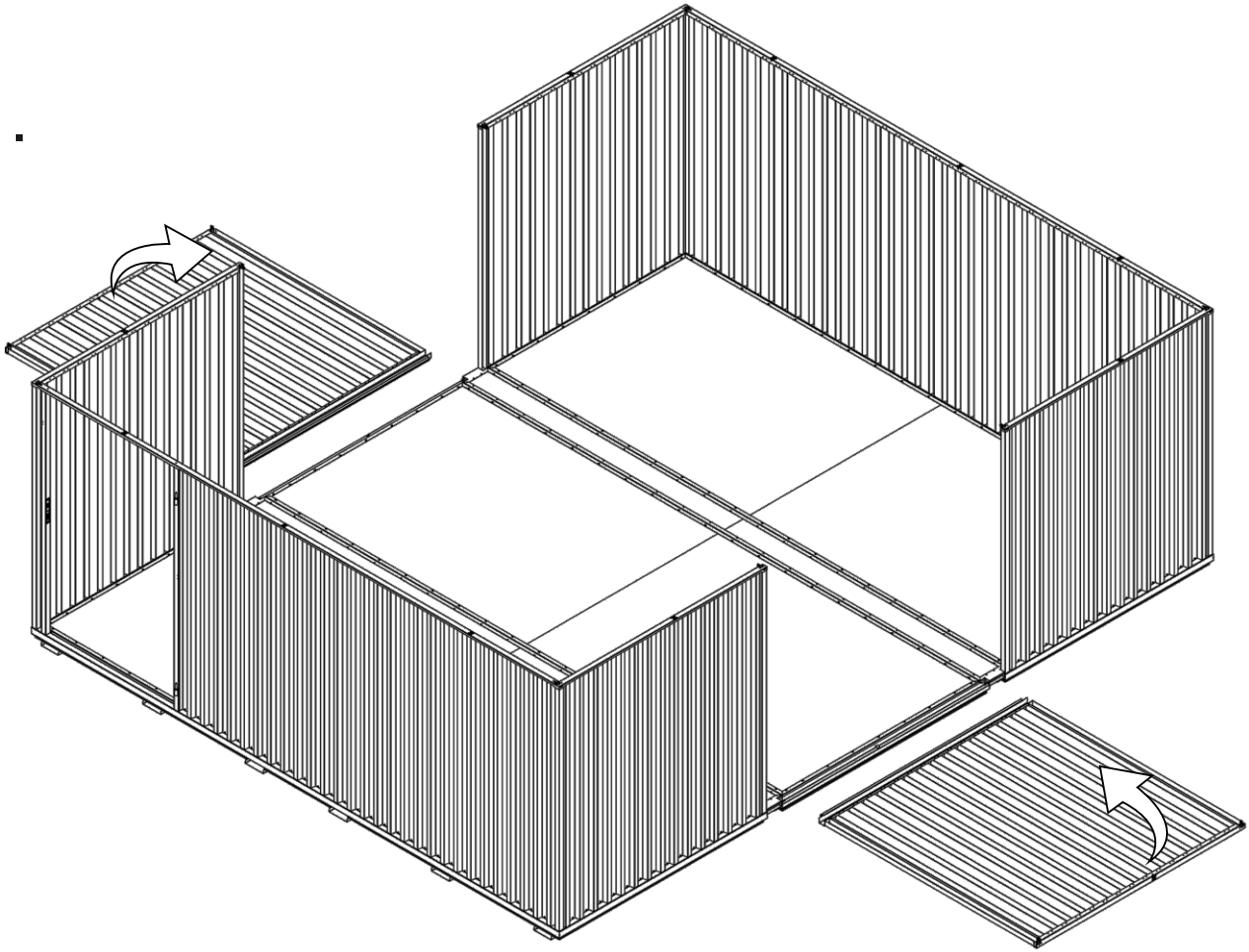

6.2.

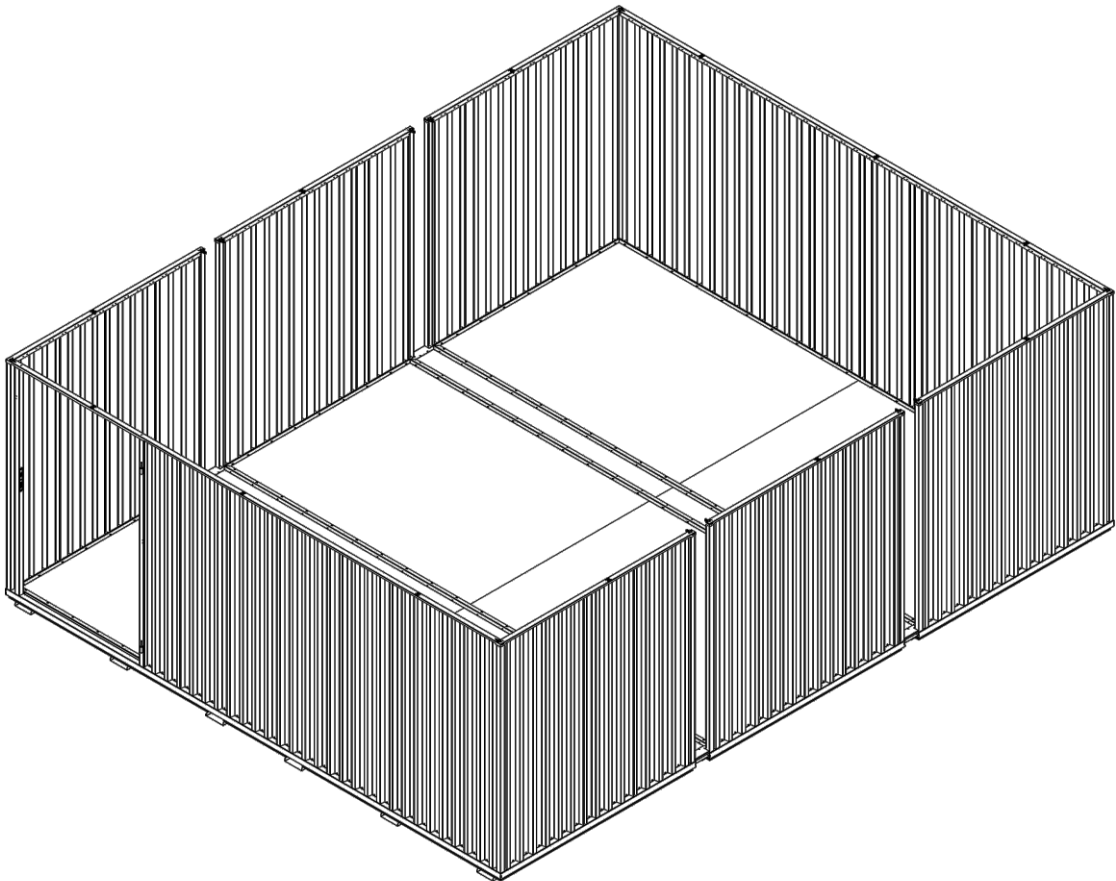

7.1.

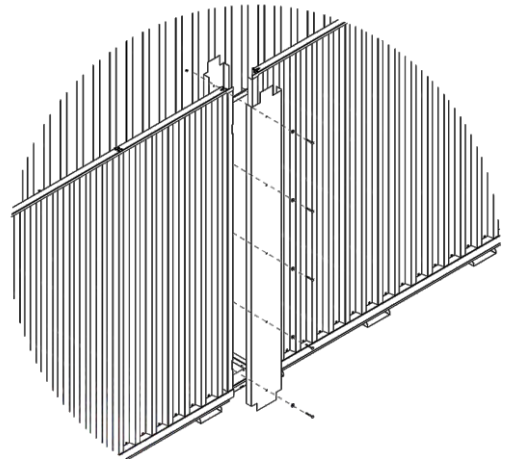
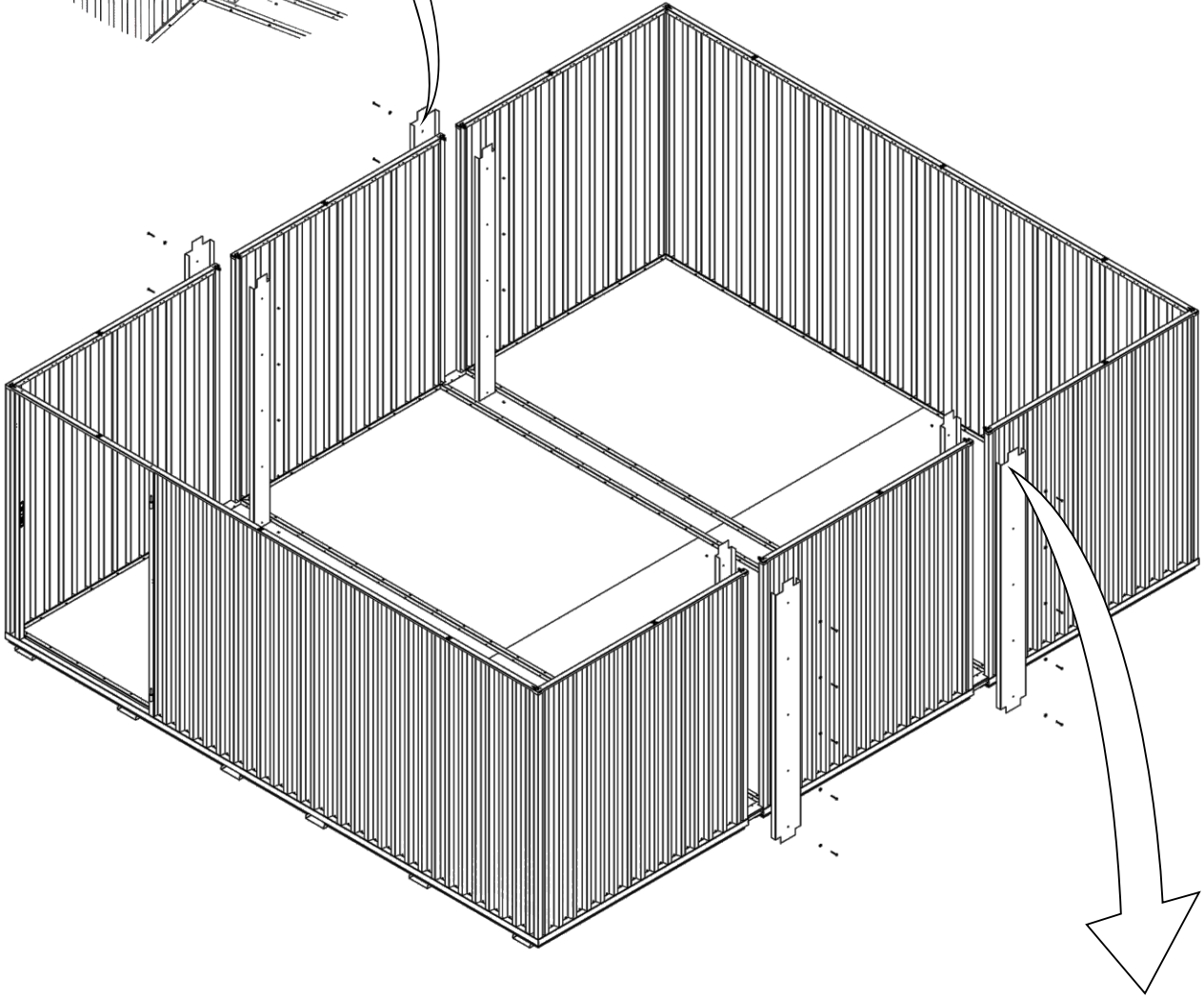
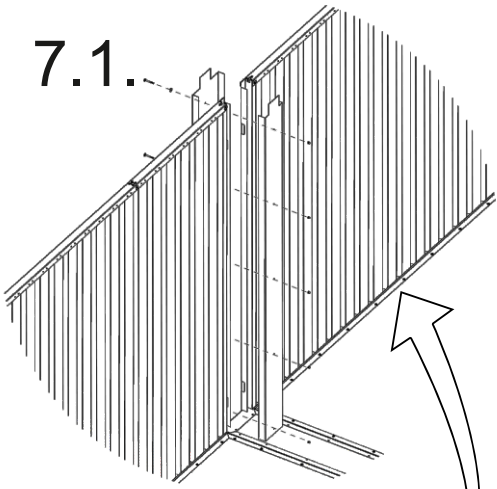

8.1.

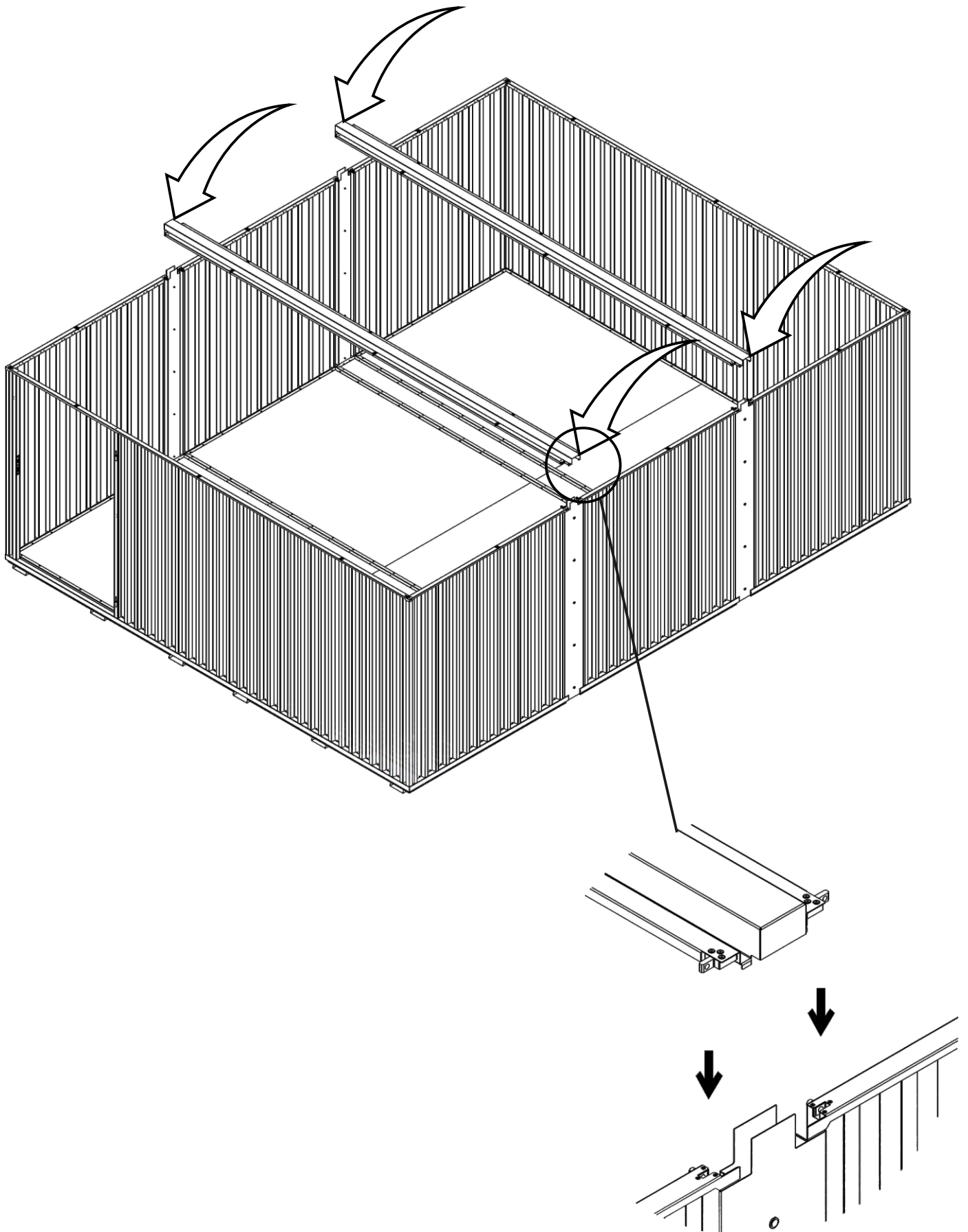

8.2.

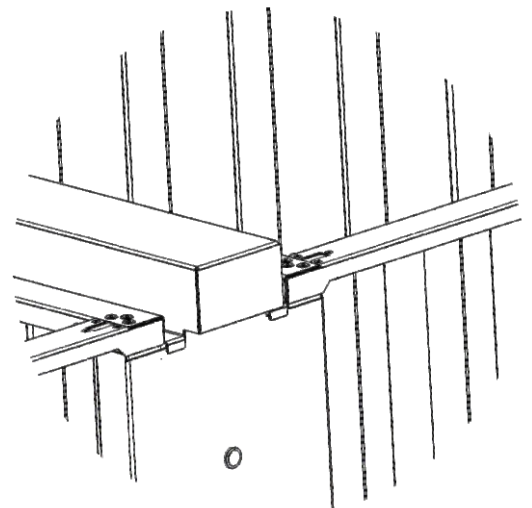
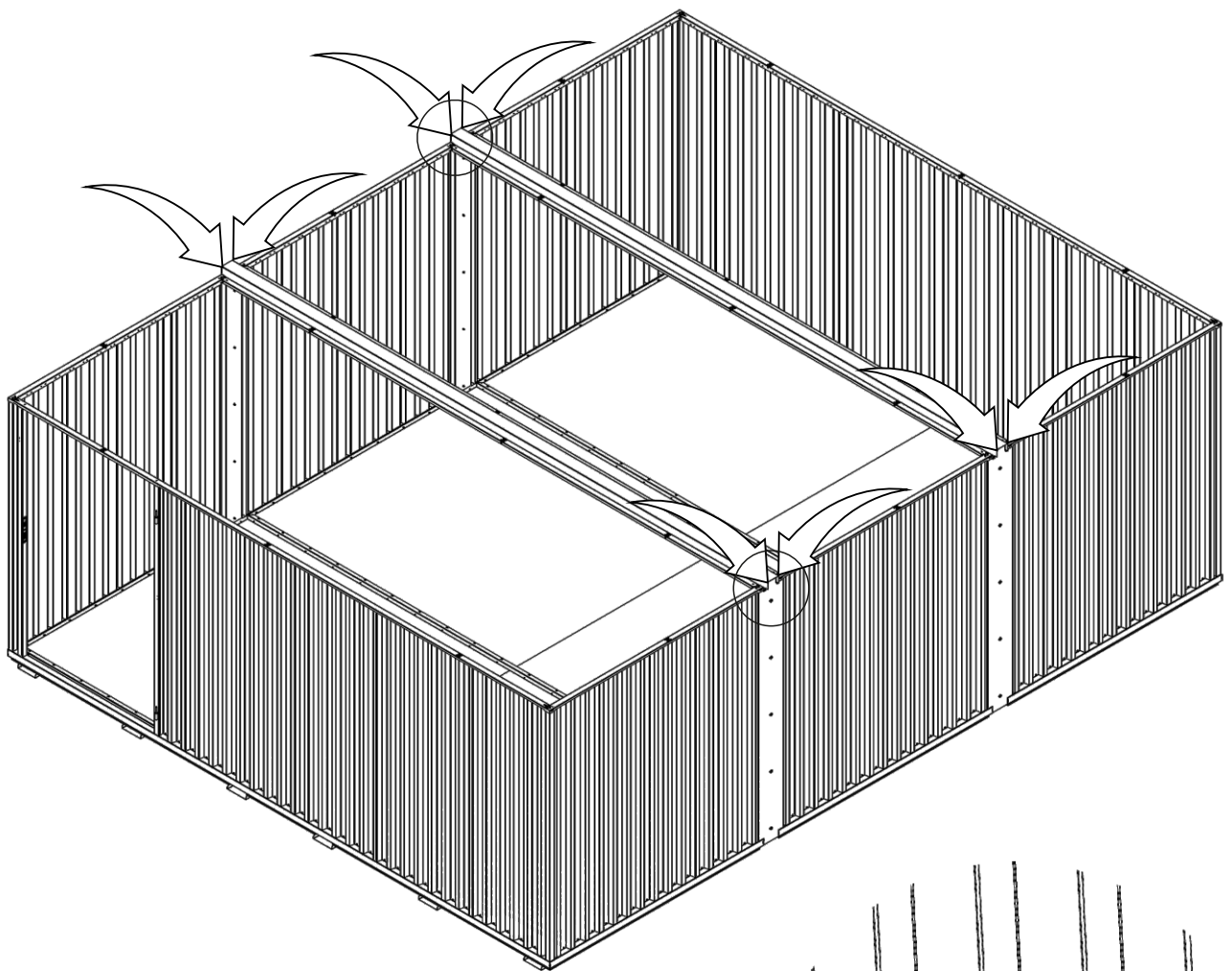
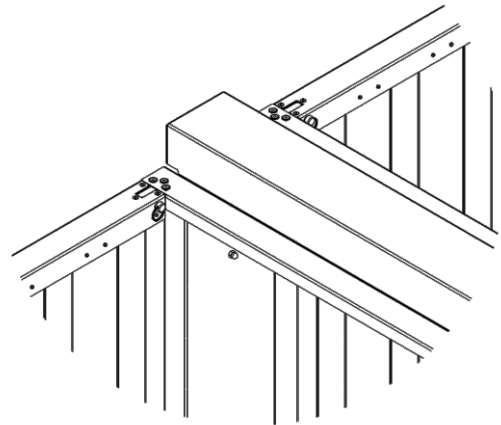
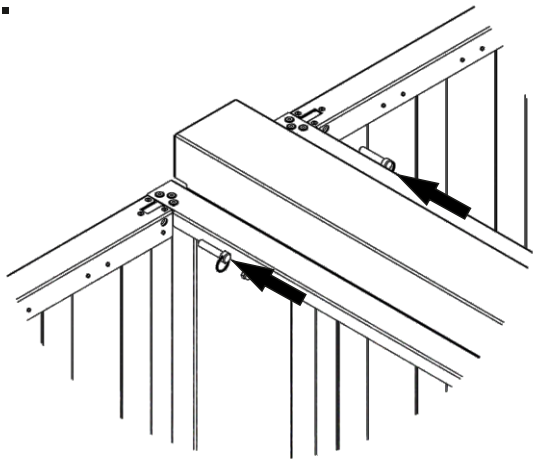

9.1.

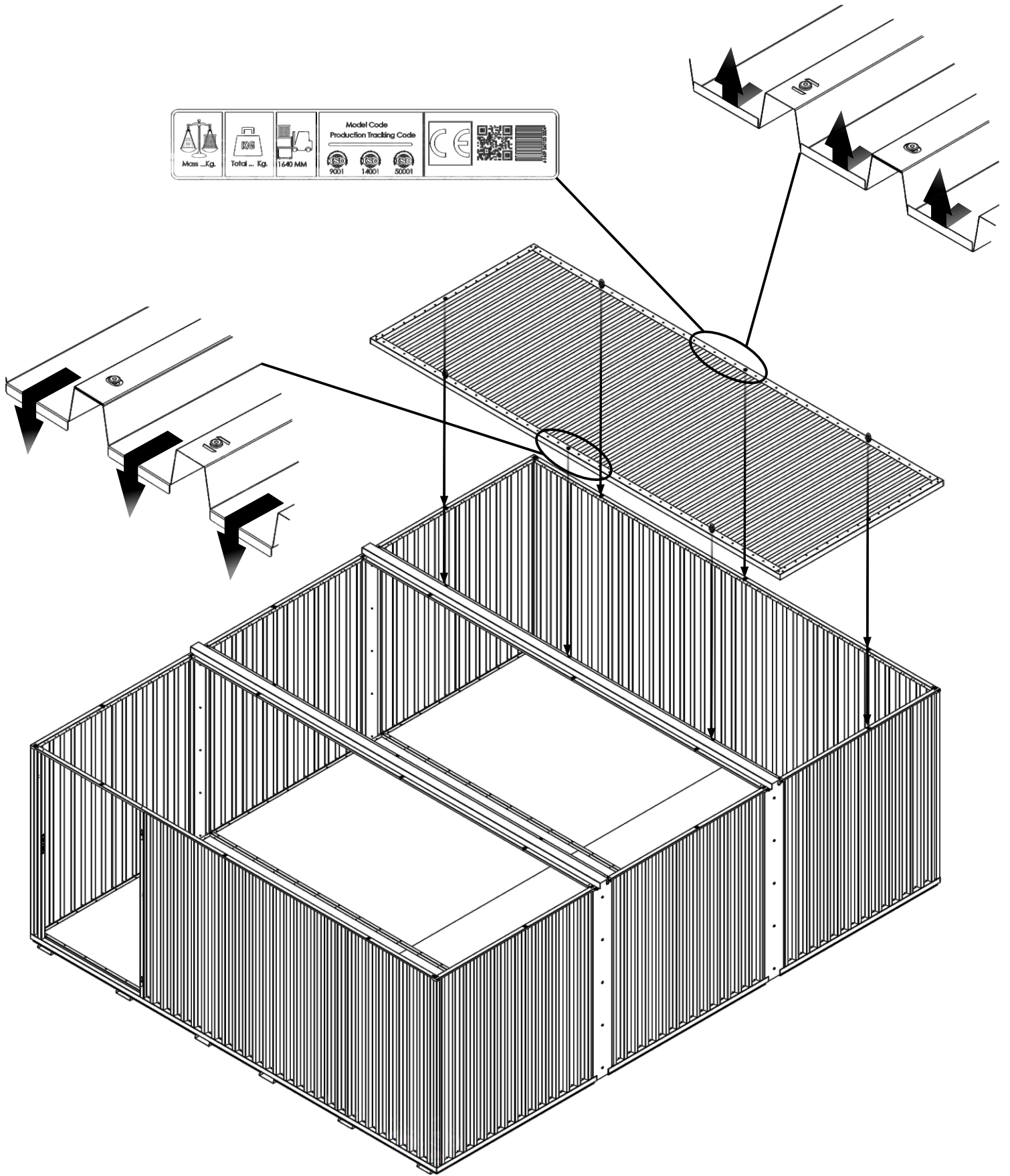



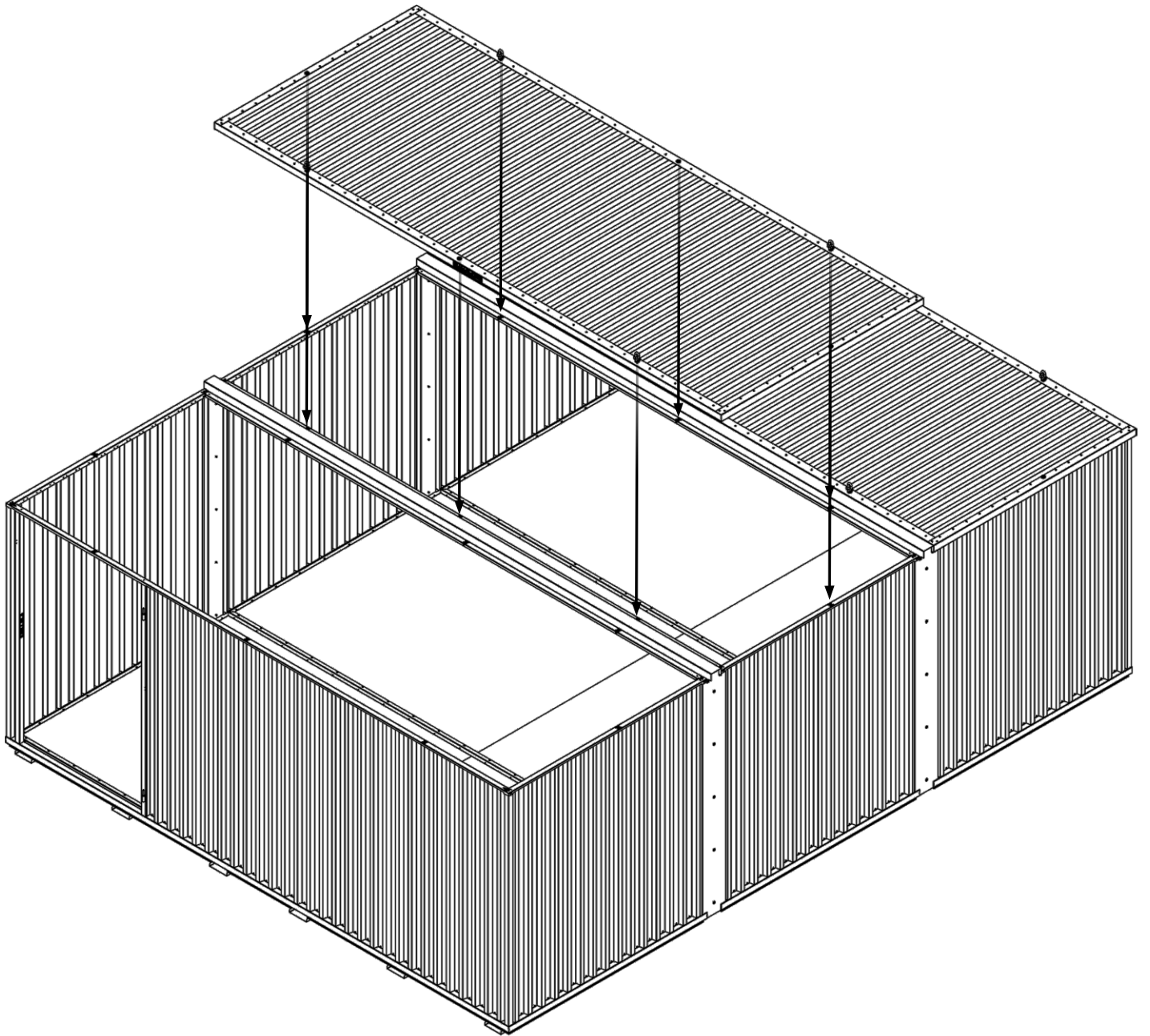



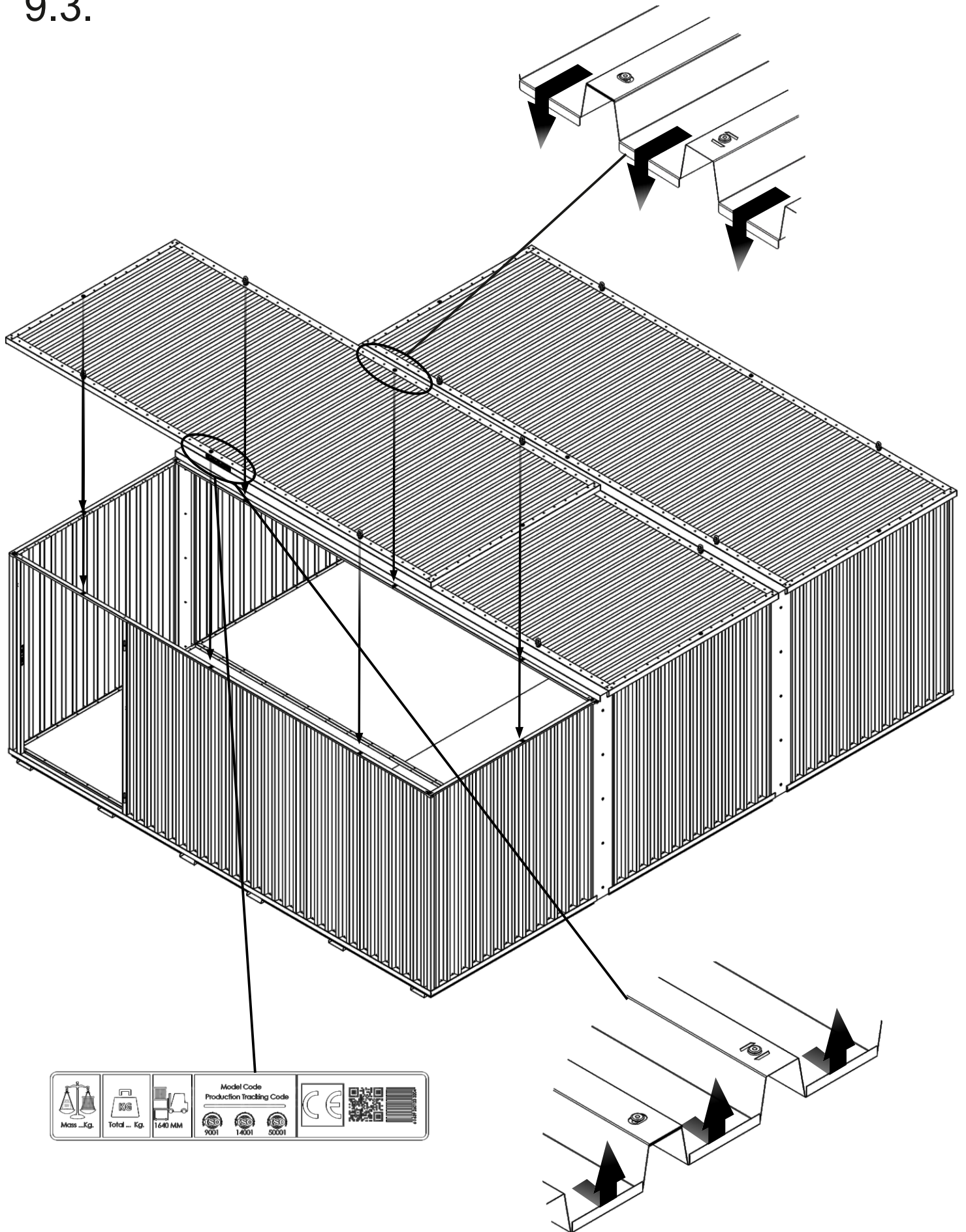

9.2.



9.3.



 Mass ...Kg.	 Total ... Kg.	 1640 MM	Model Code Production Tracking Code			
			 9001	 14001	 50001	

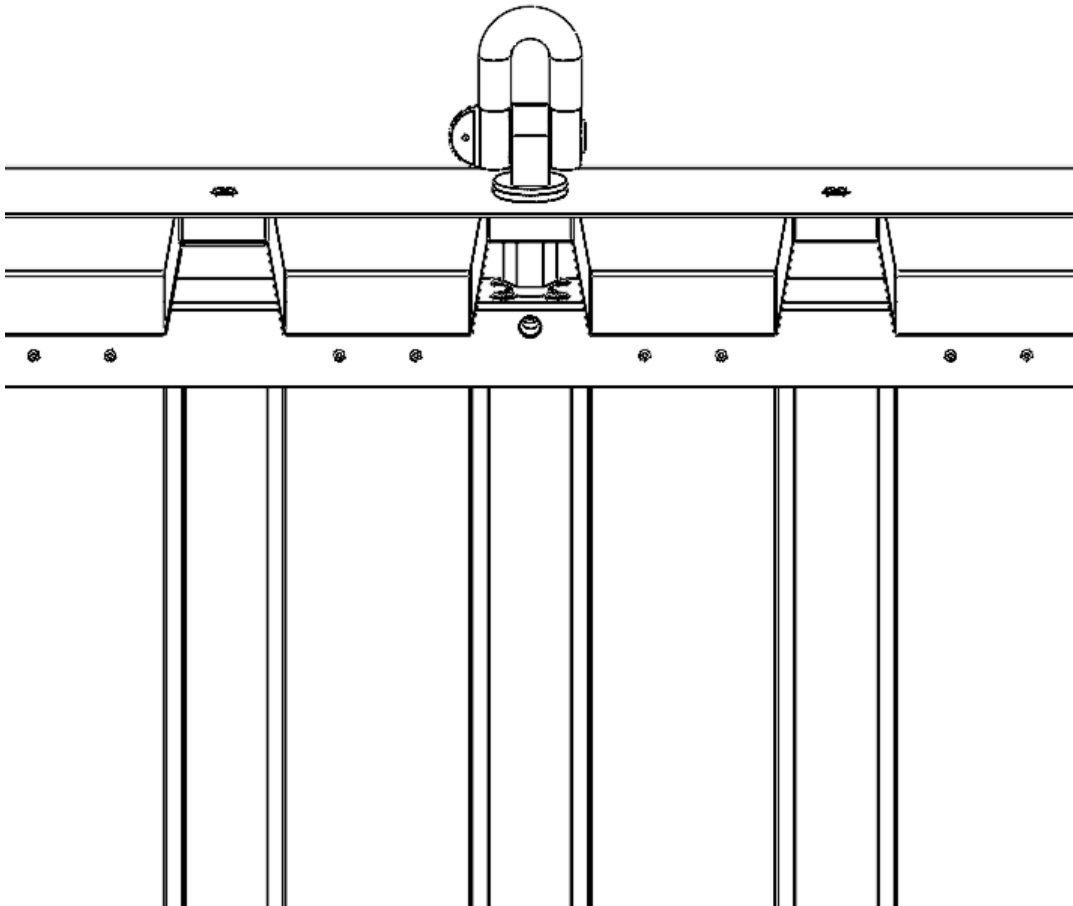
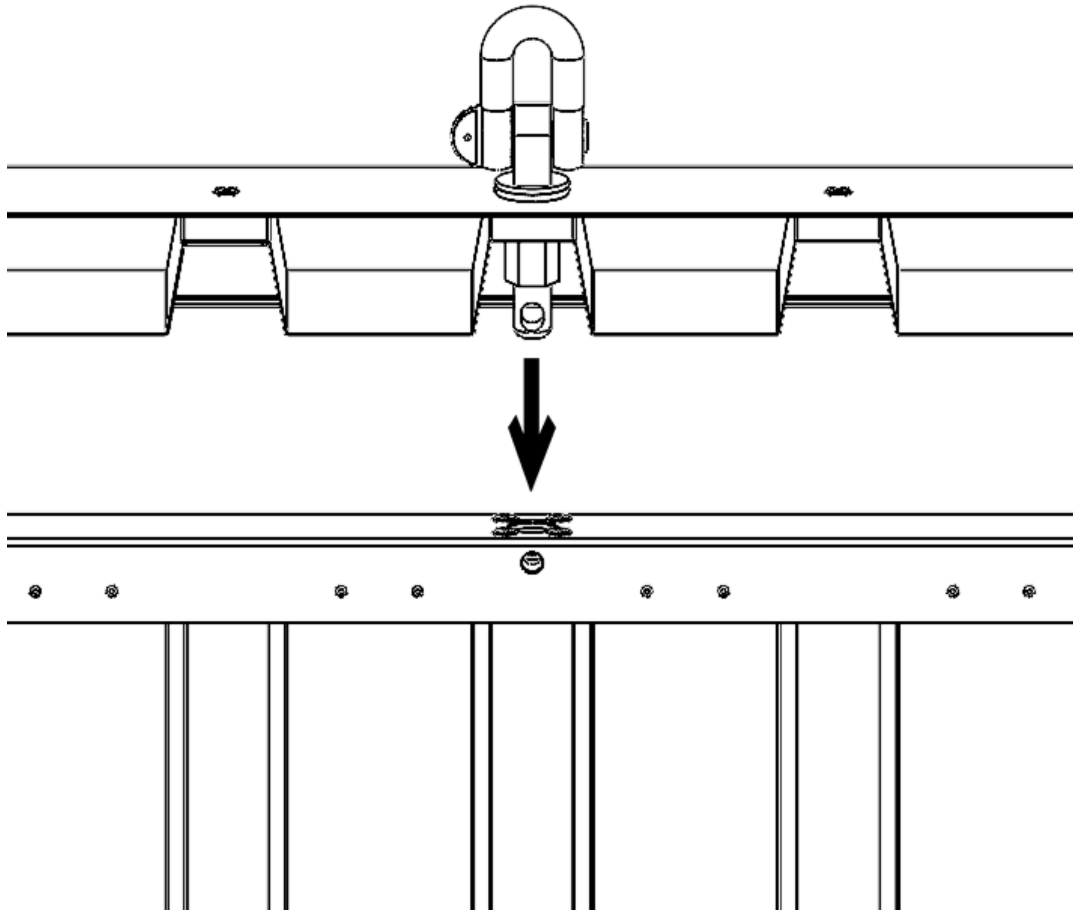

9.4.

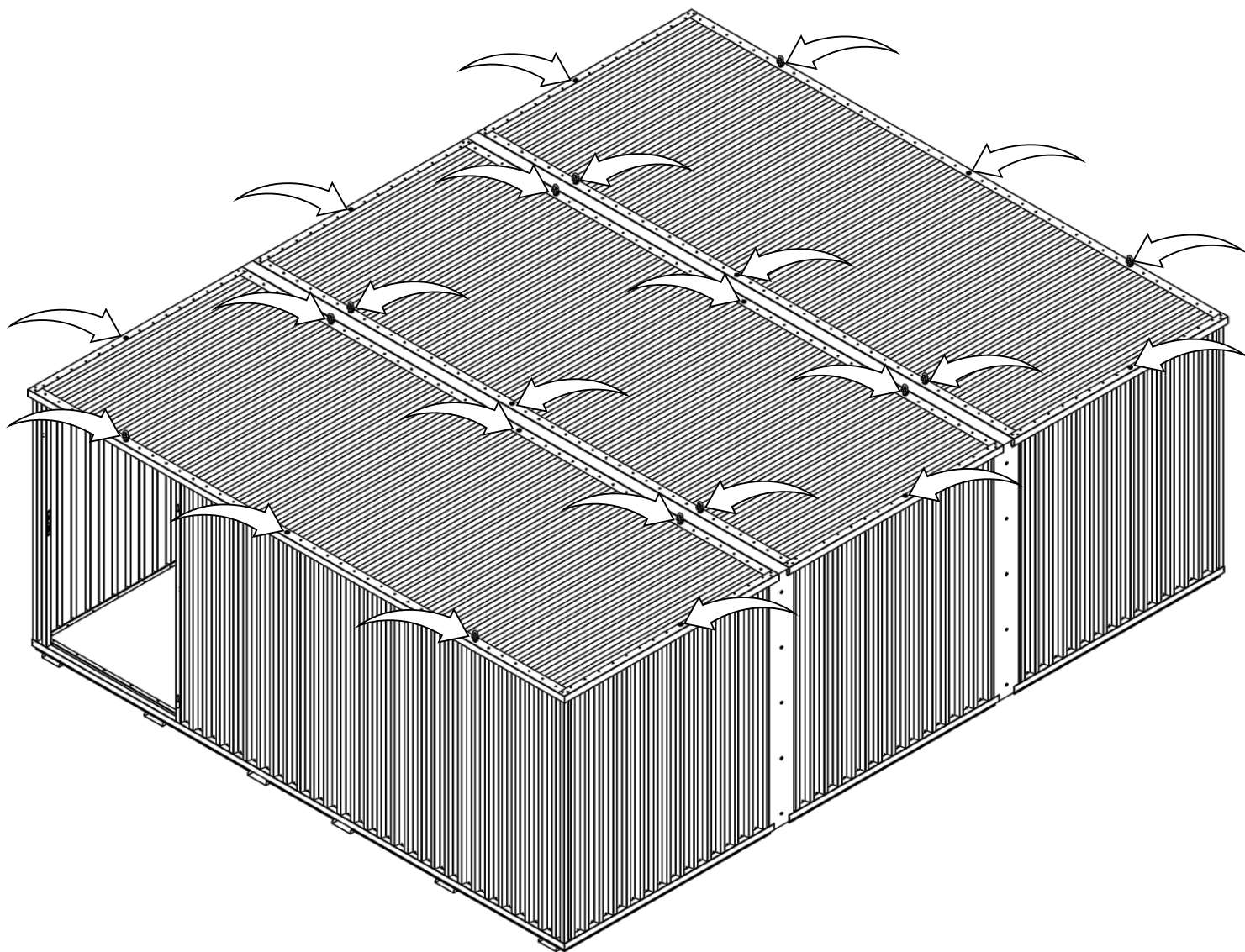

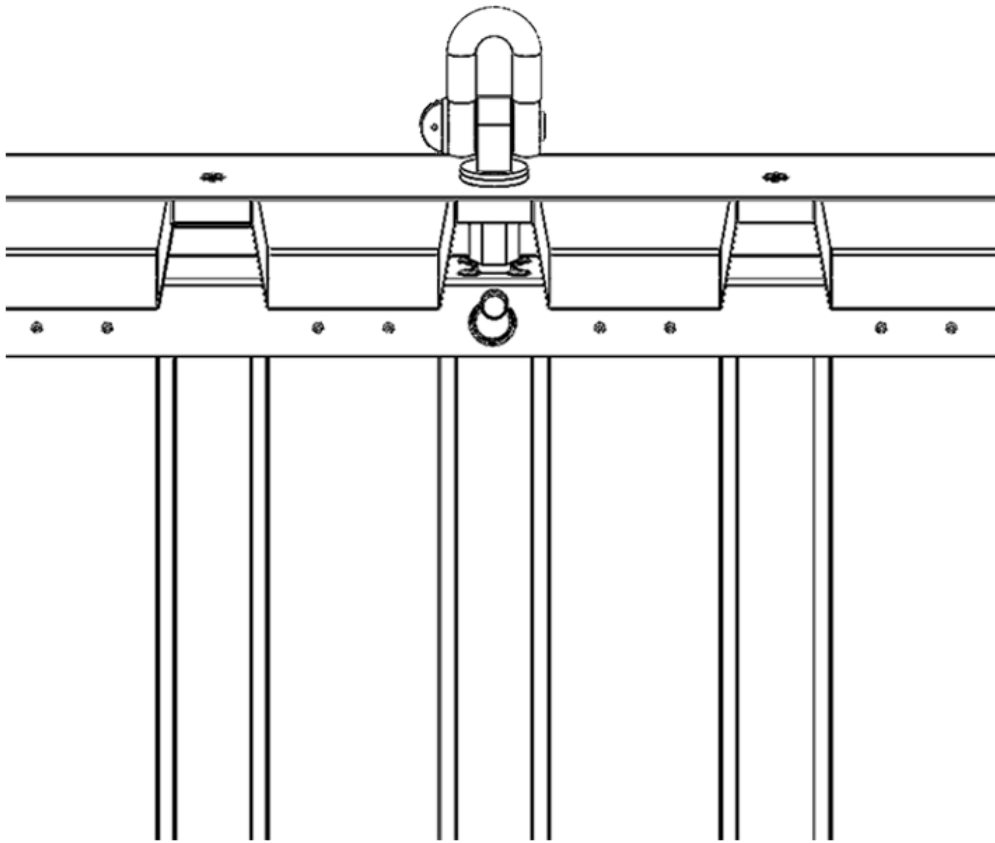
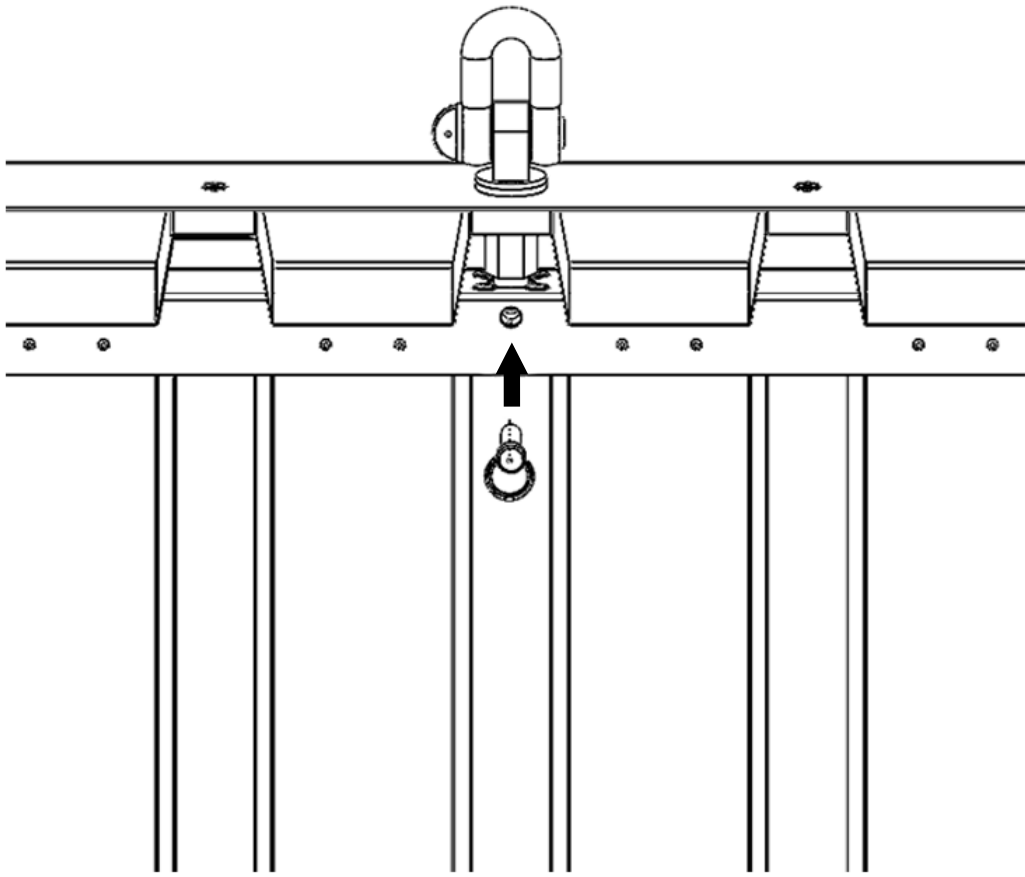

10.1.

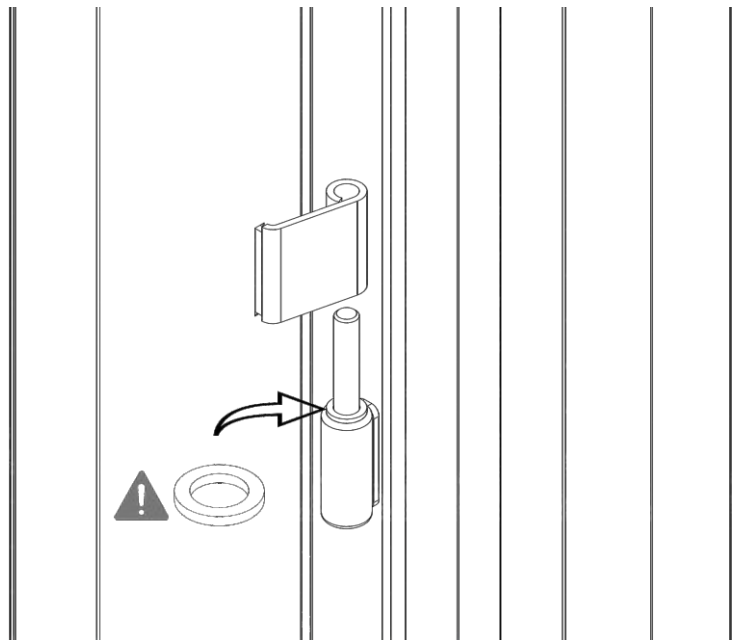
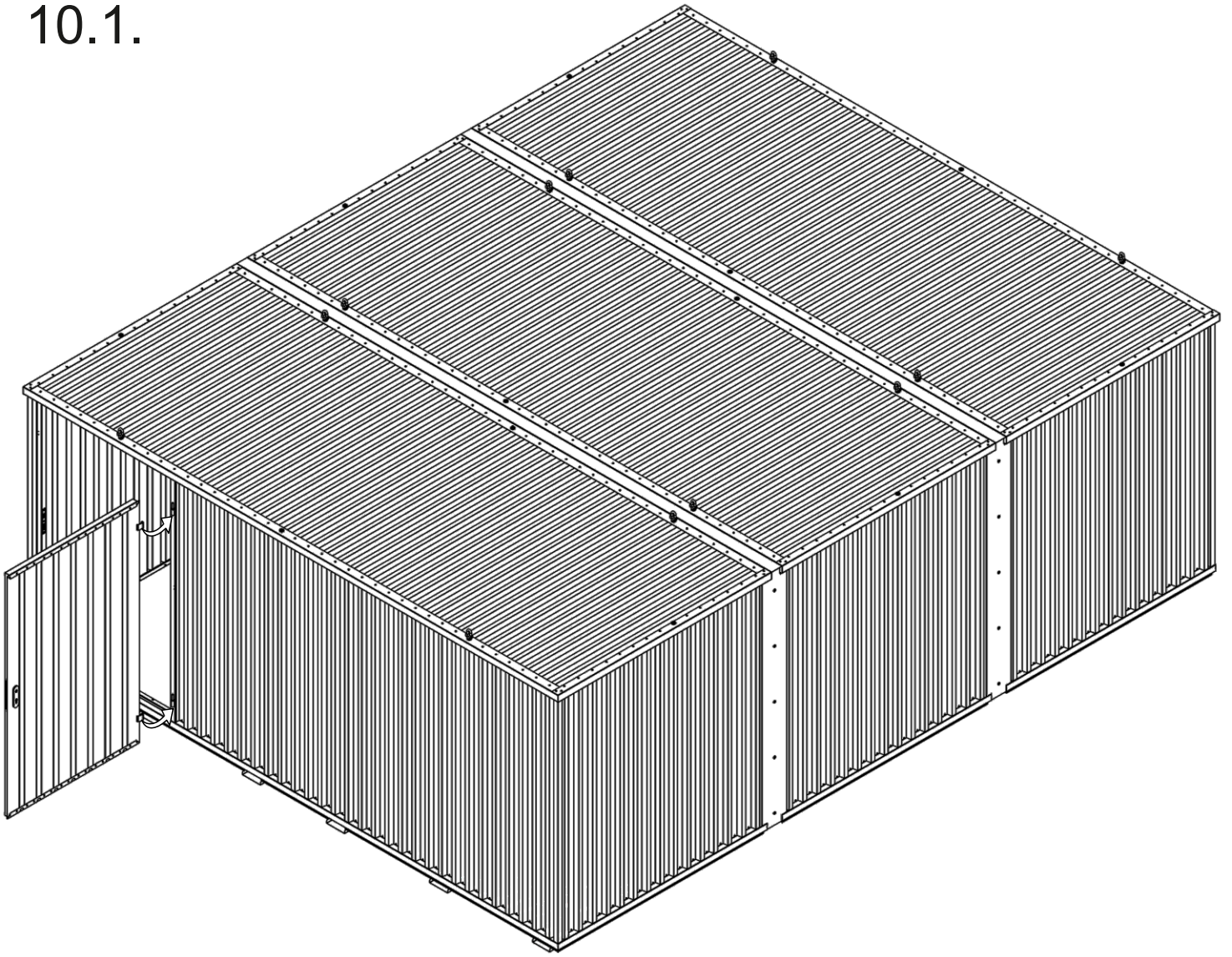

10.2.

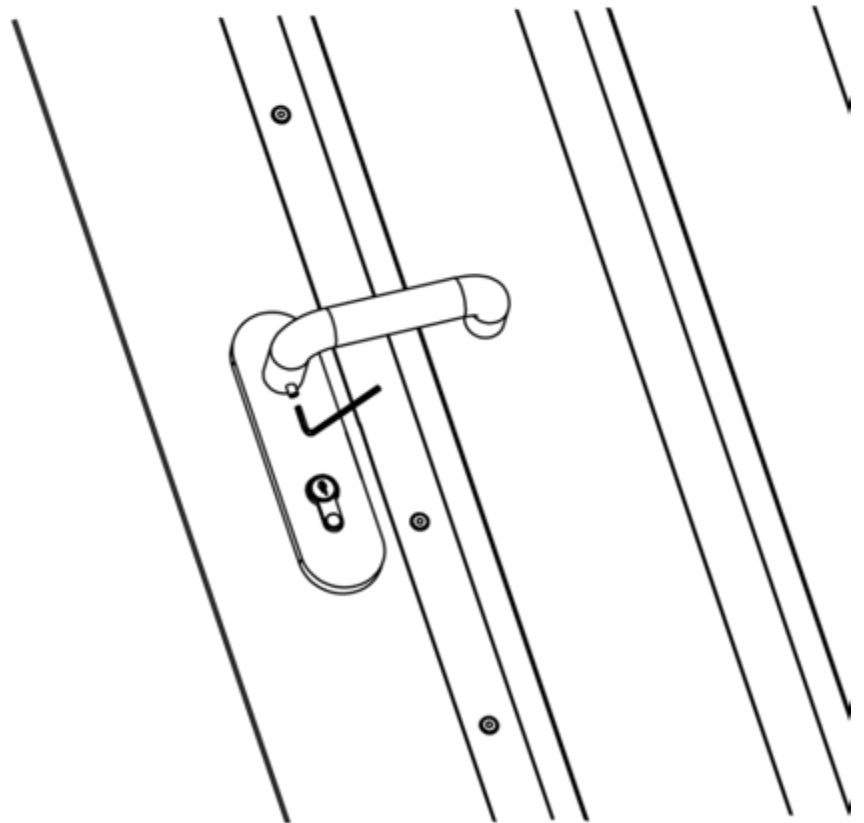
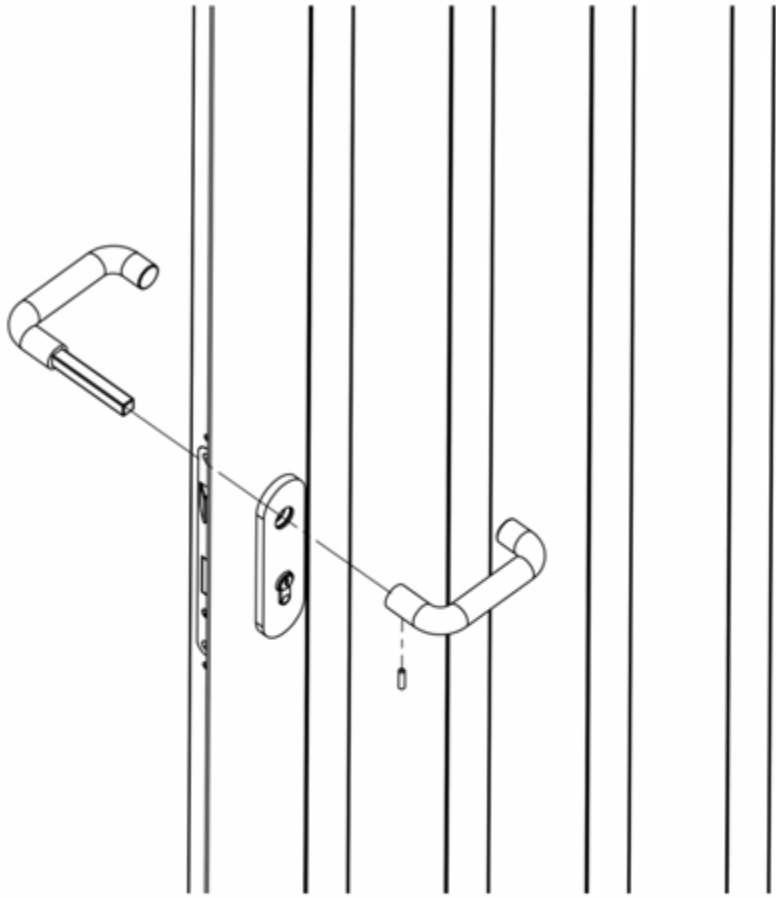

11.1.

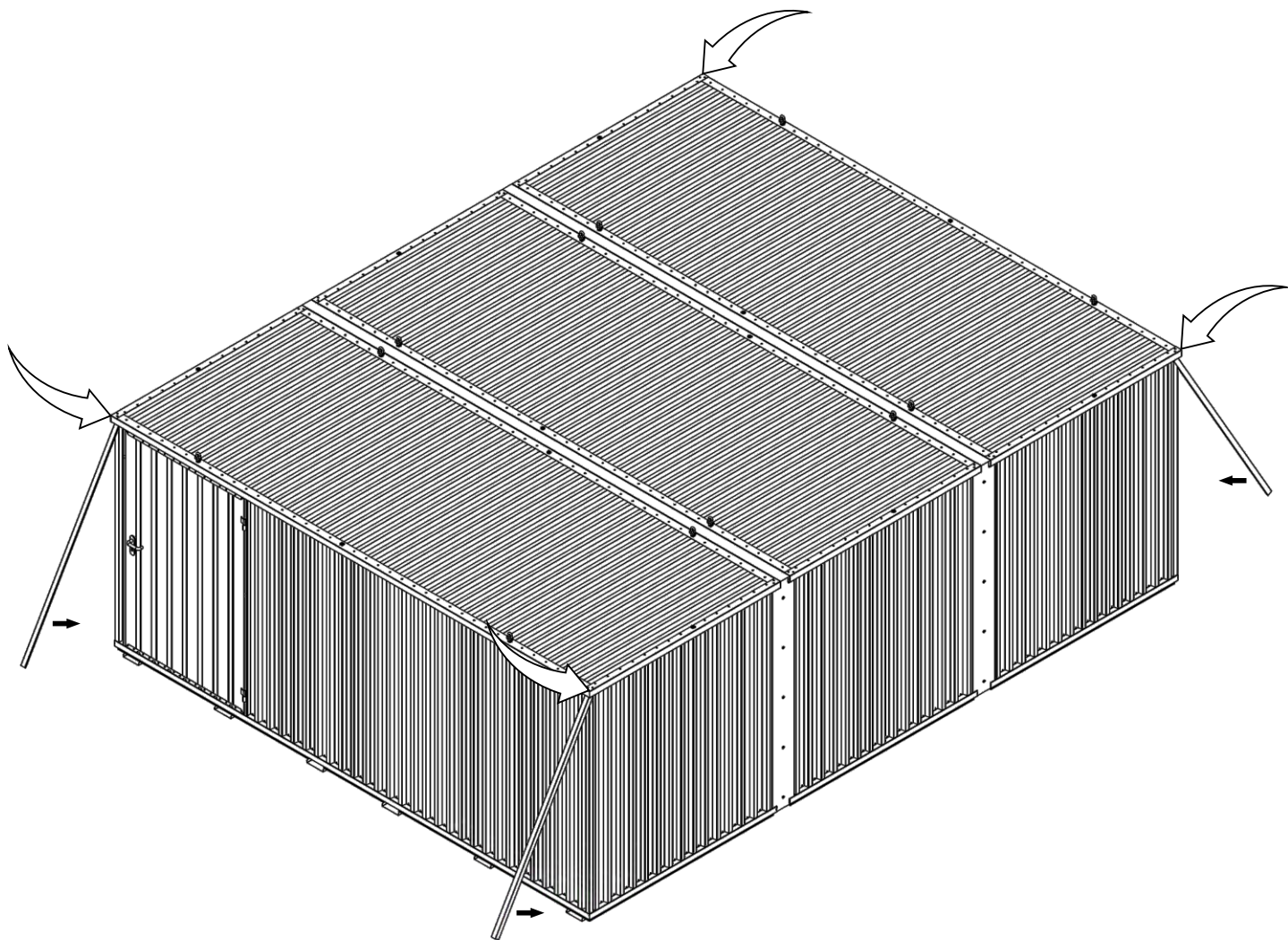

12.1.

