







PRODUCT CODE : 4040.110.450.320



	24 pcs.
	2 pcs.
	2 pcs.
	10 pcs.
	10 pcs.
	10 pcs.

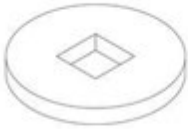

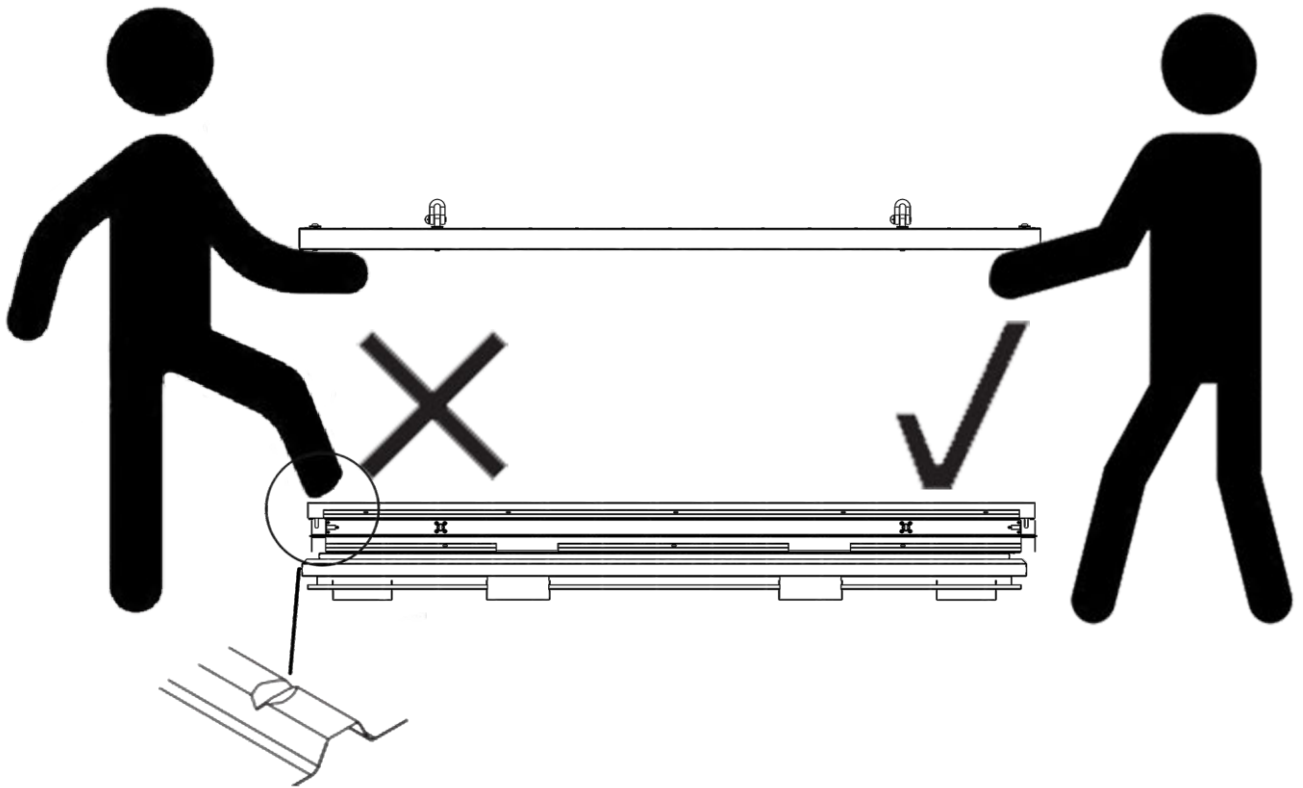
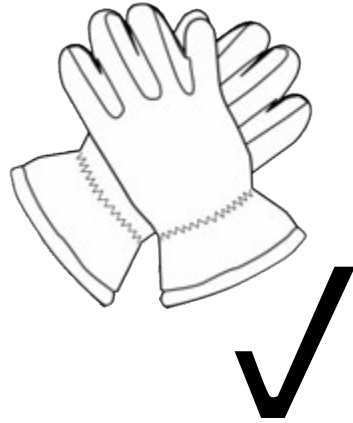
1.1.

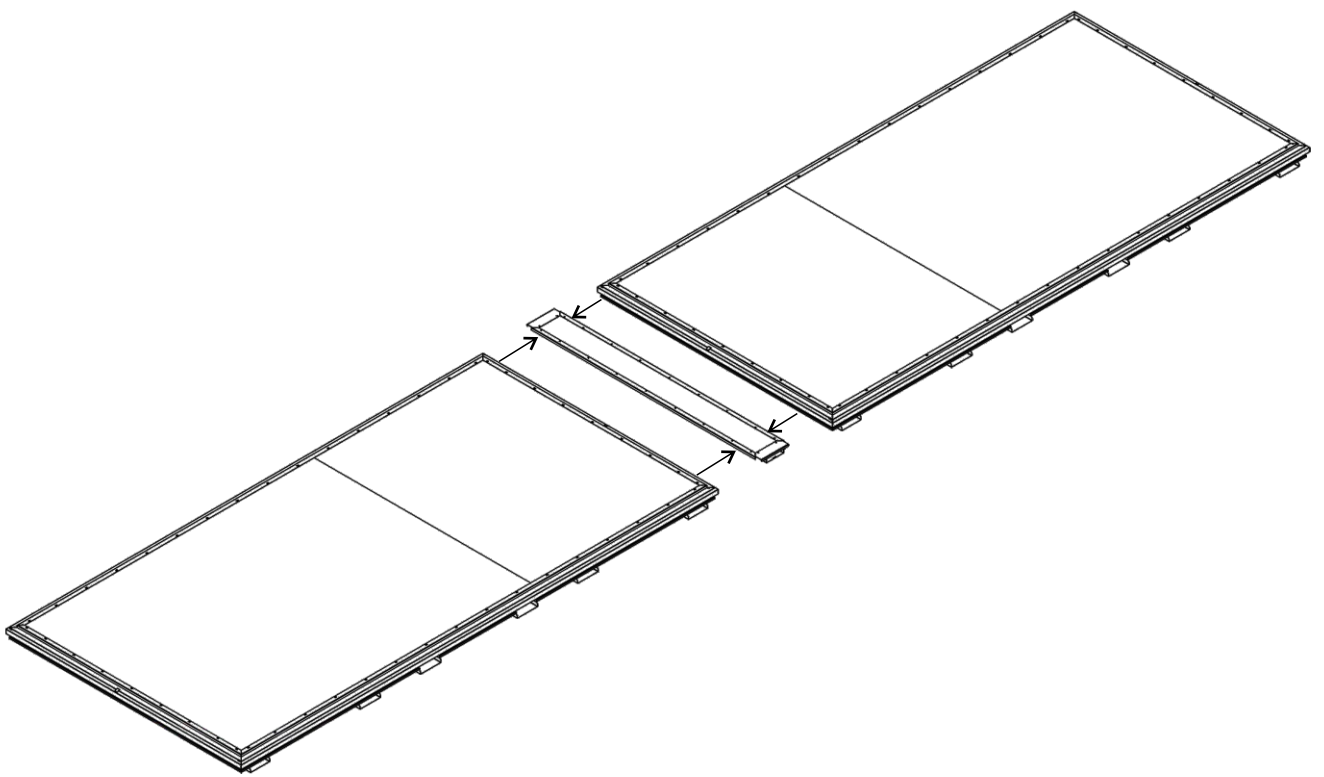

1.2.

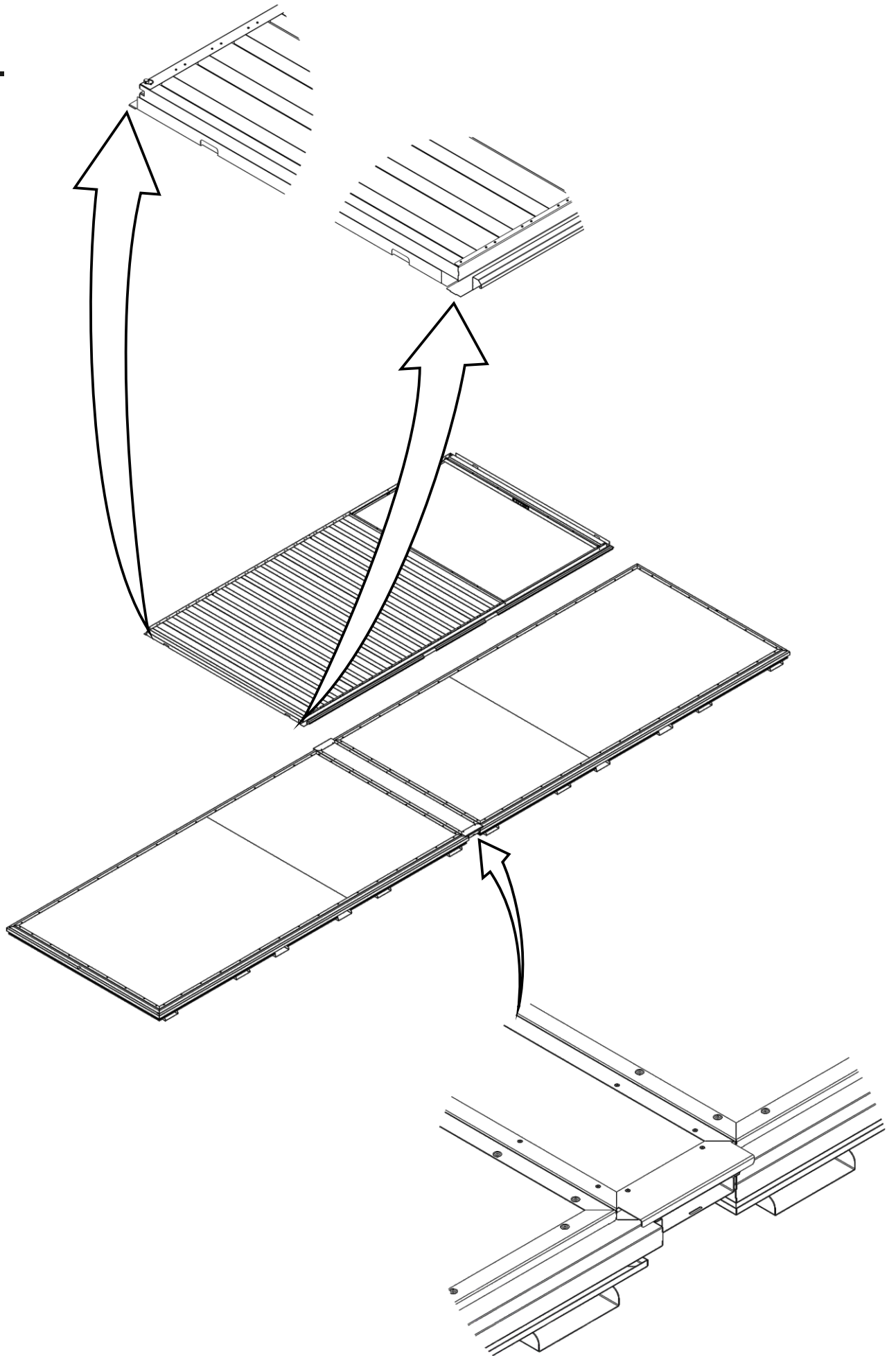

2.1.

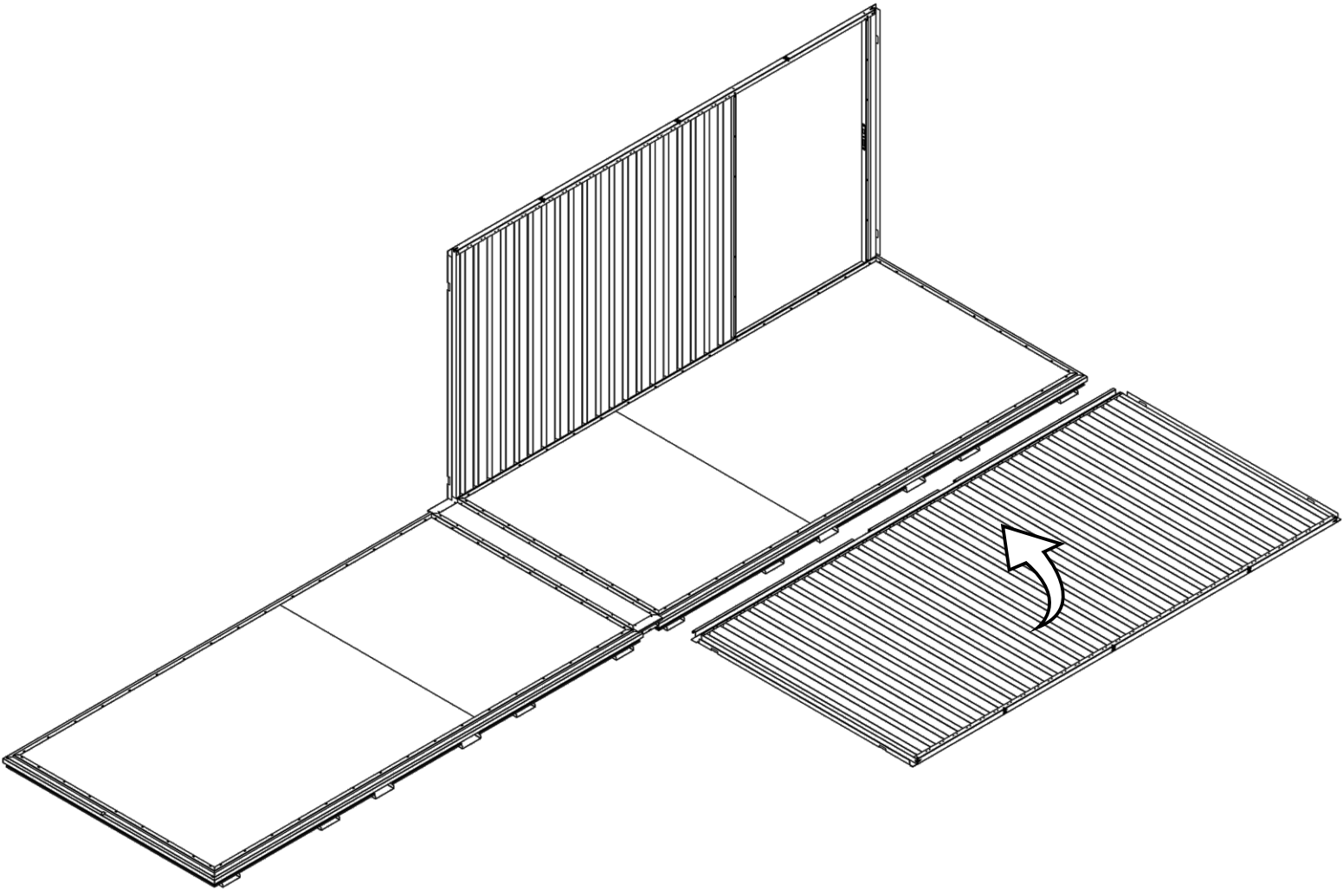

3.1.

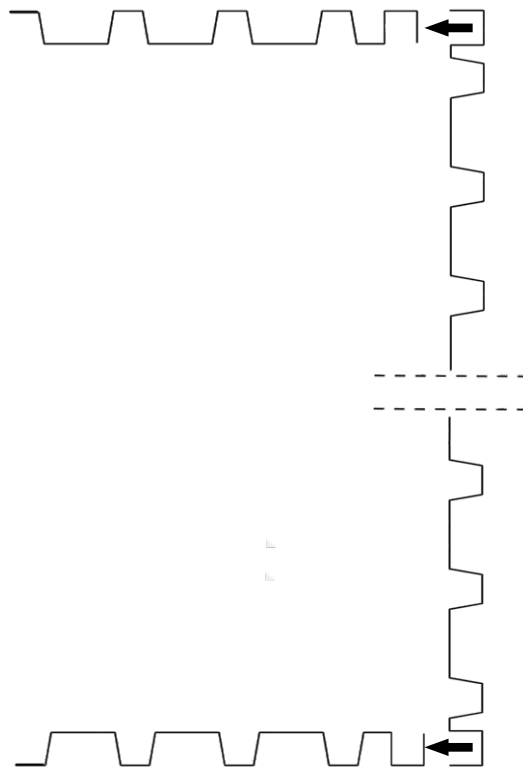
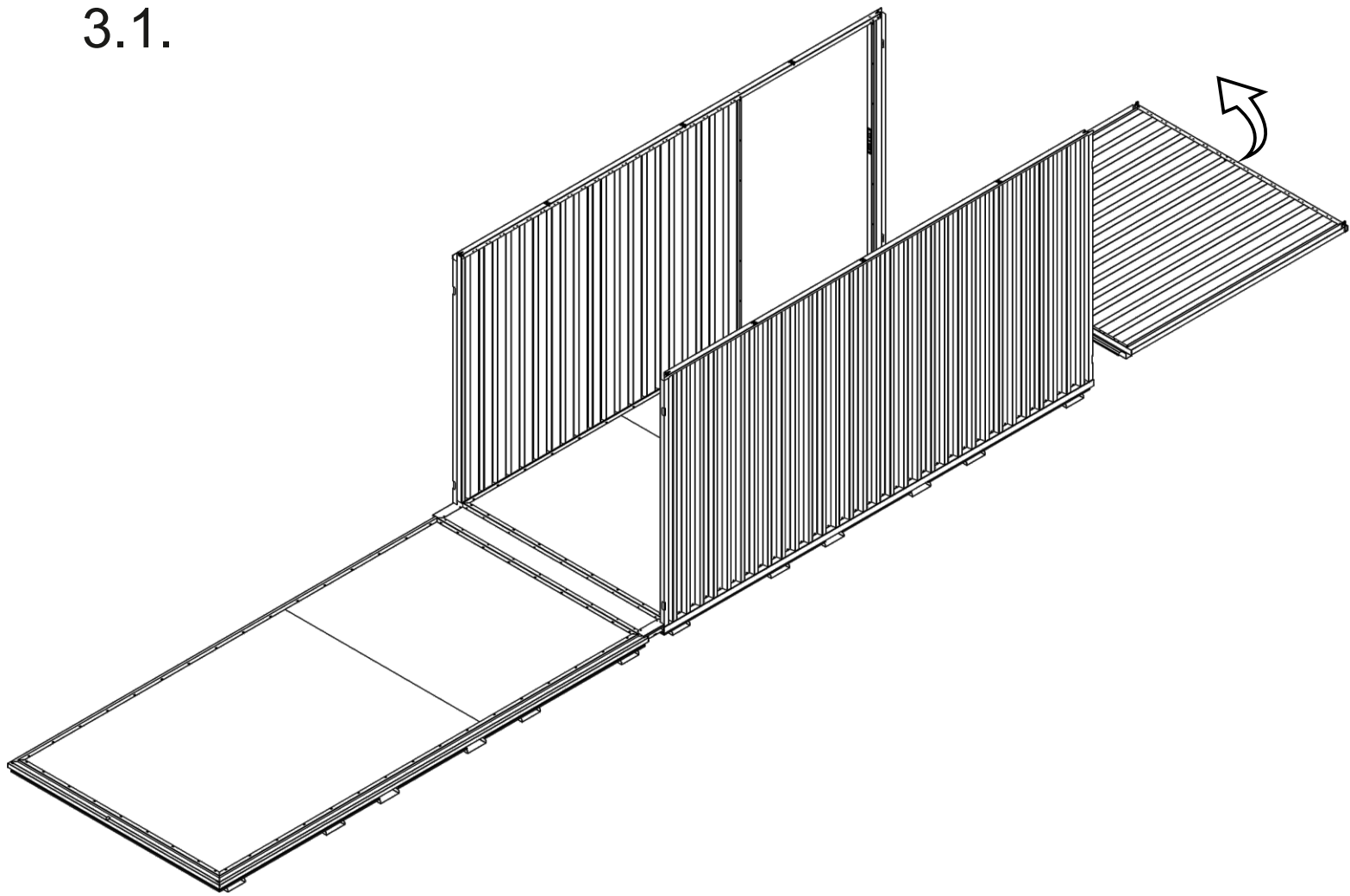

3.2.

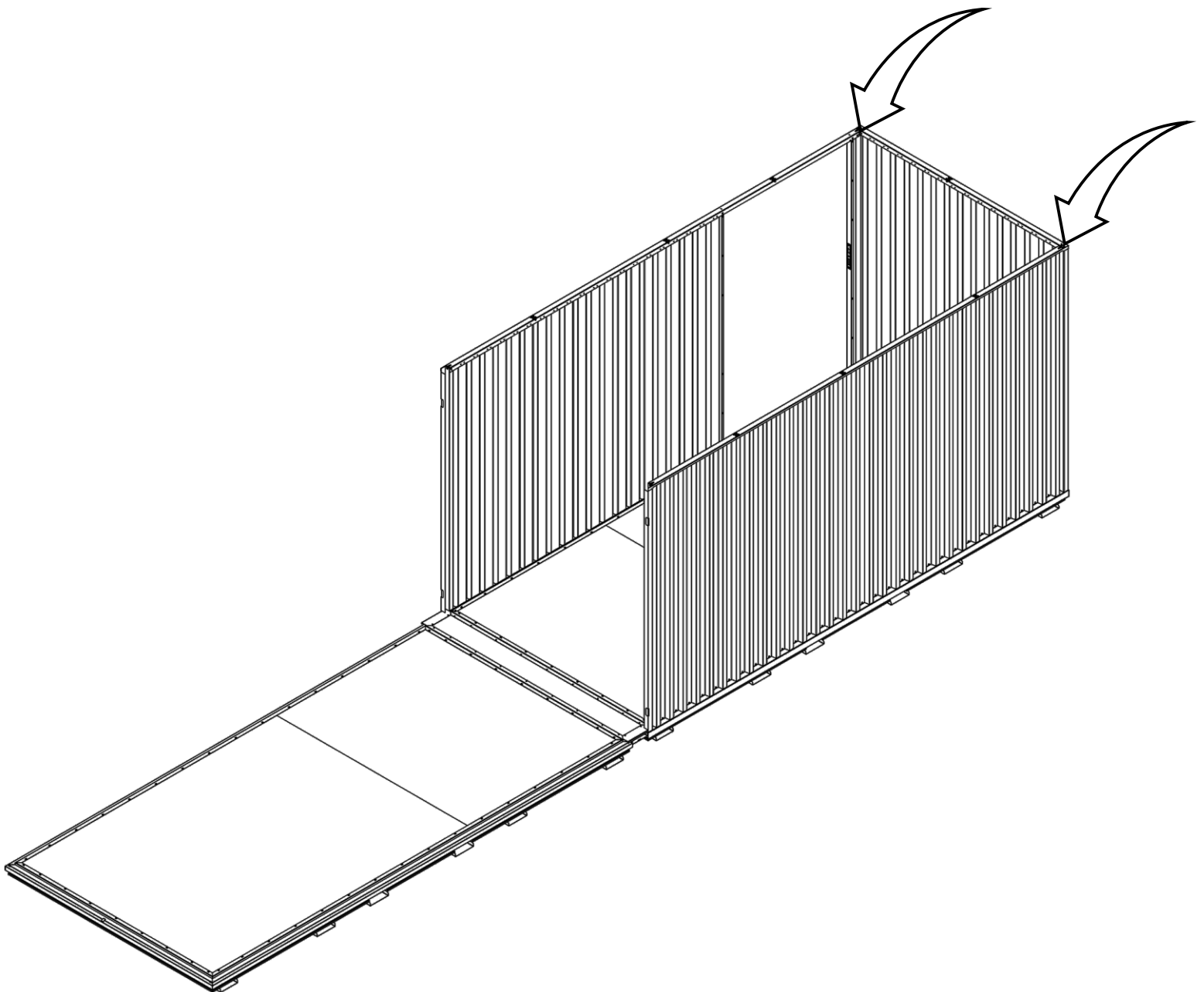
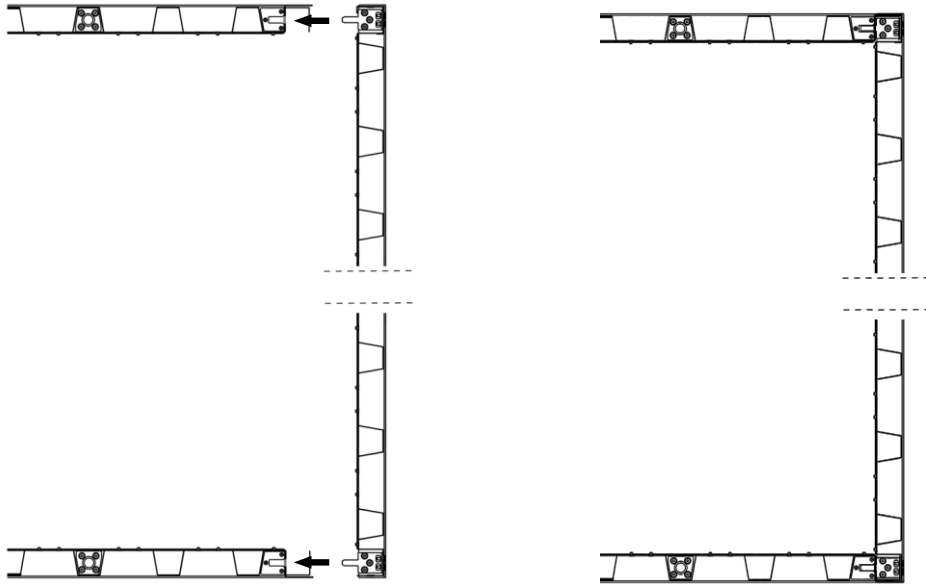

3.3.

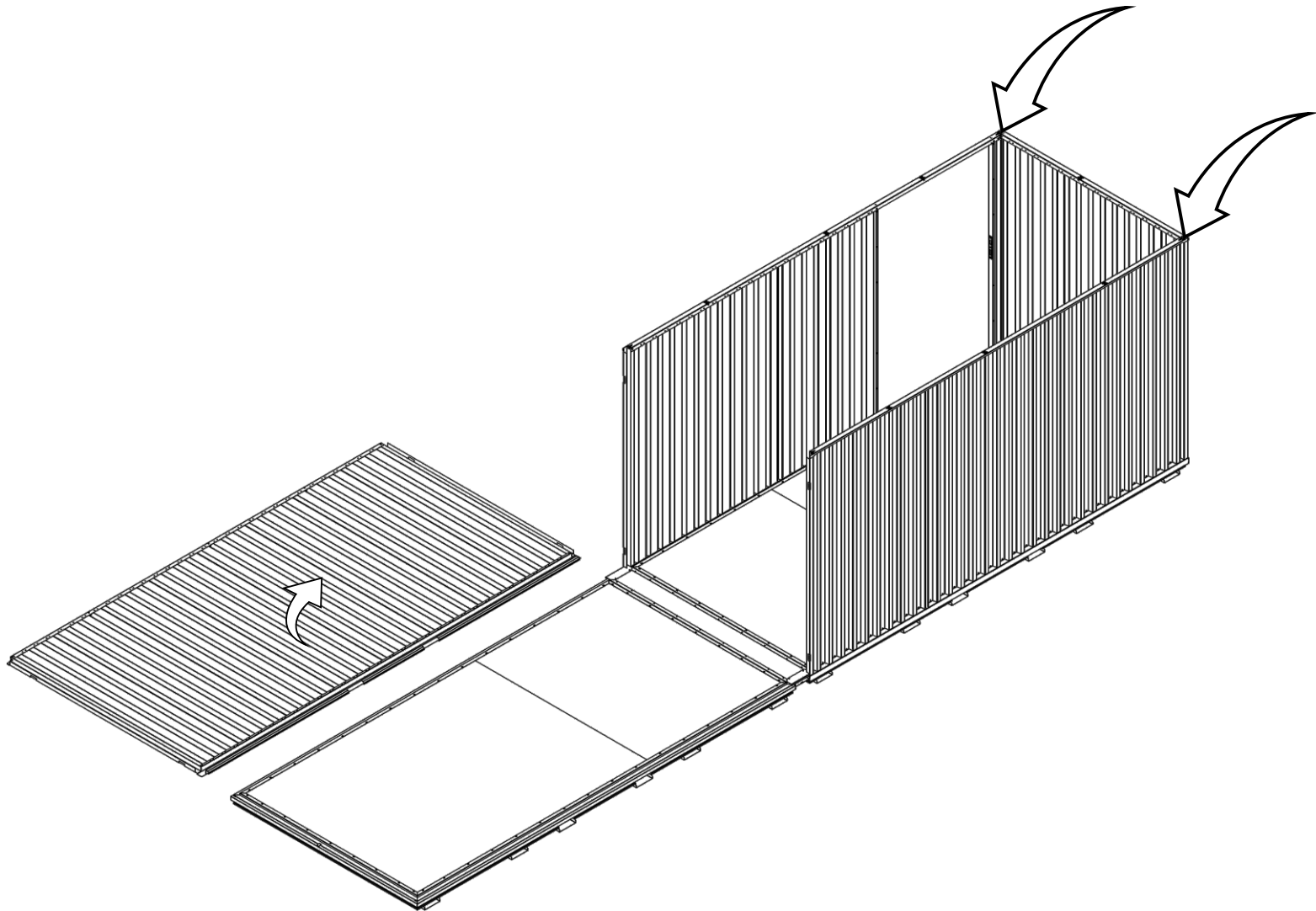
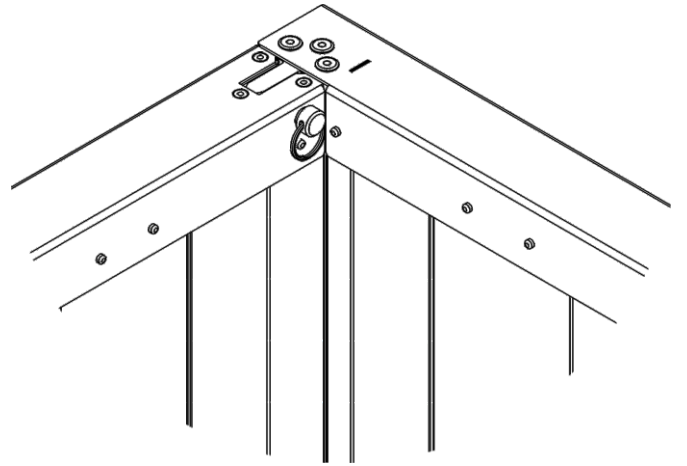
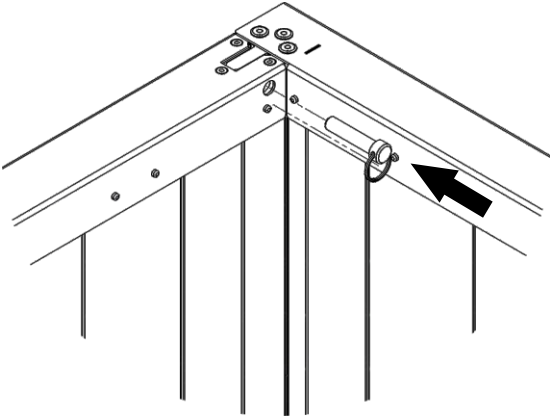

4.1.

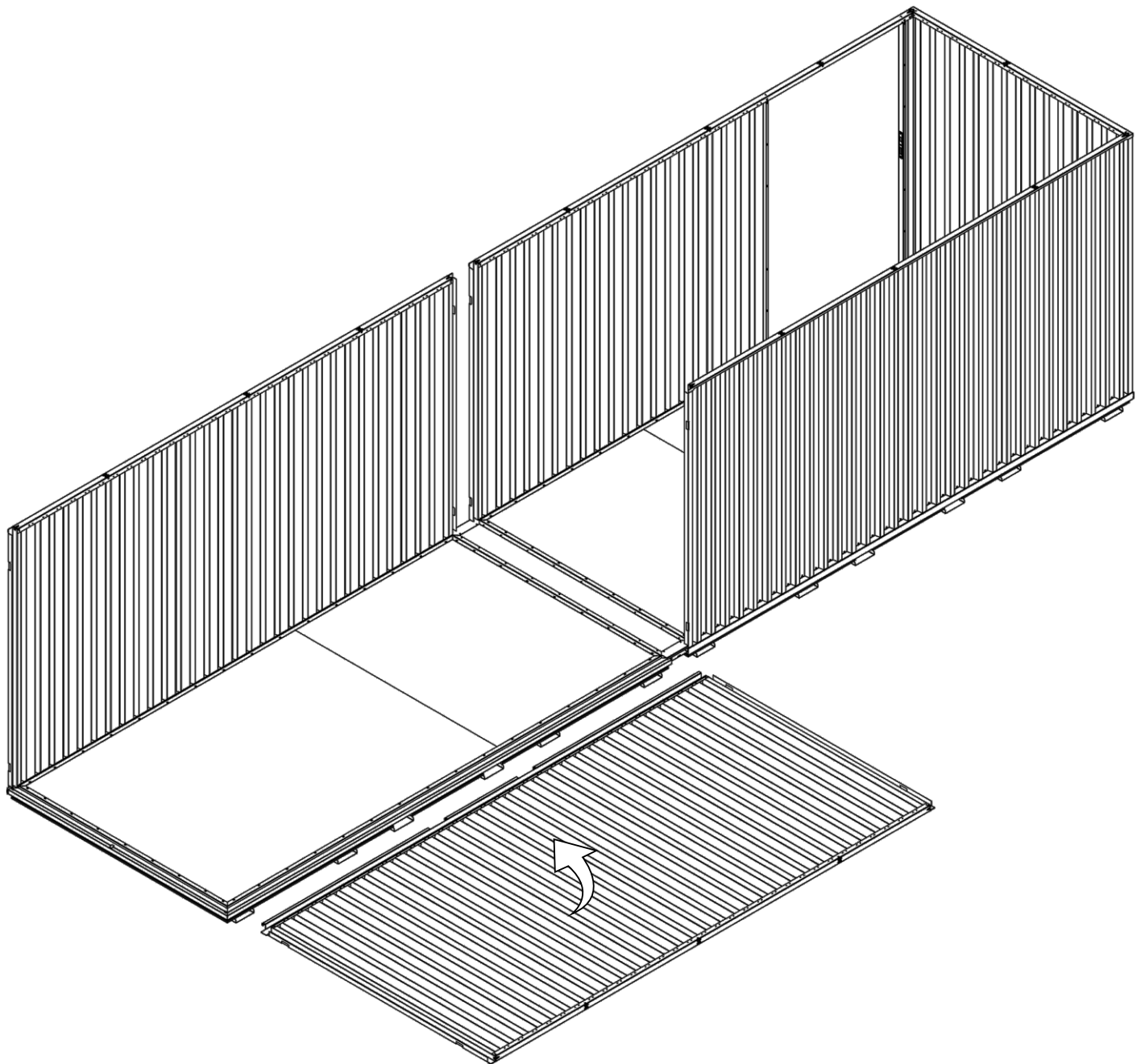

5.1.

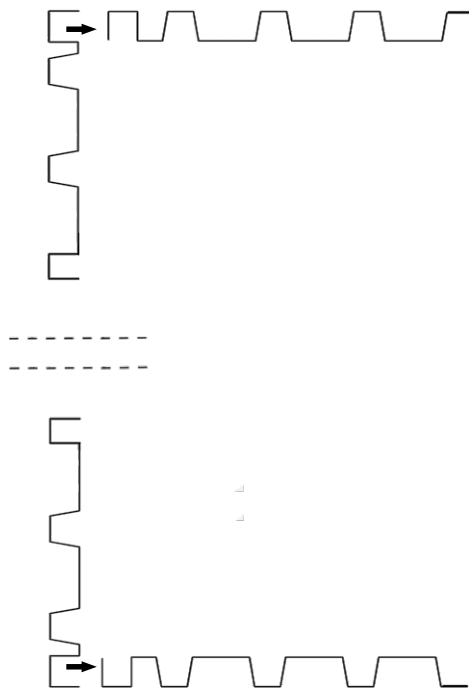
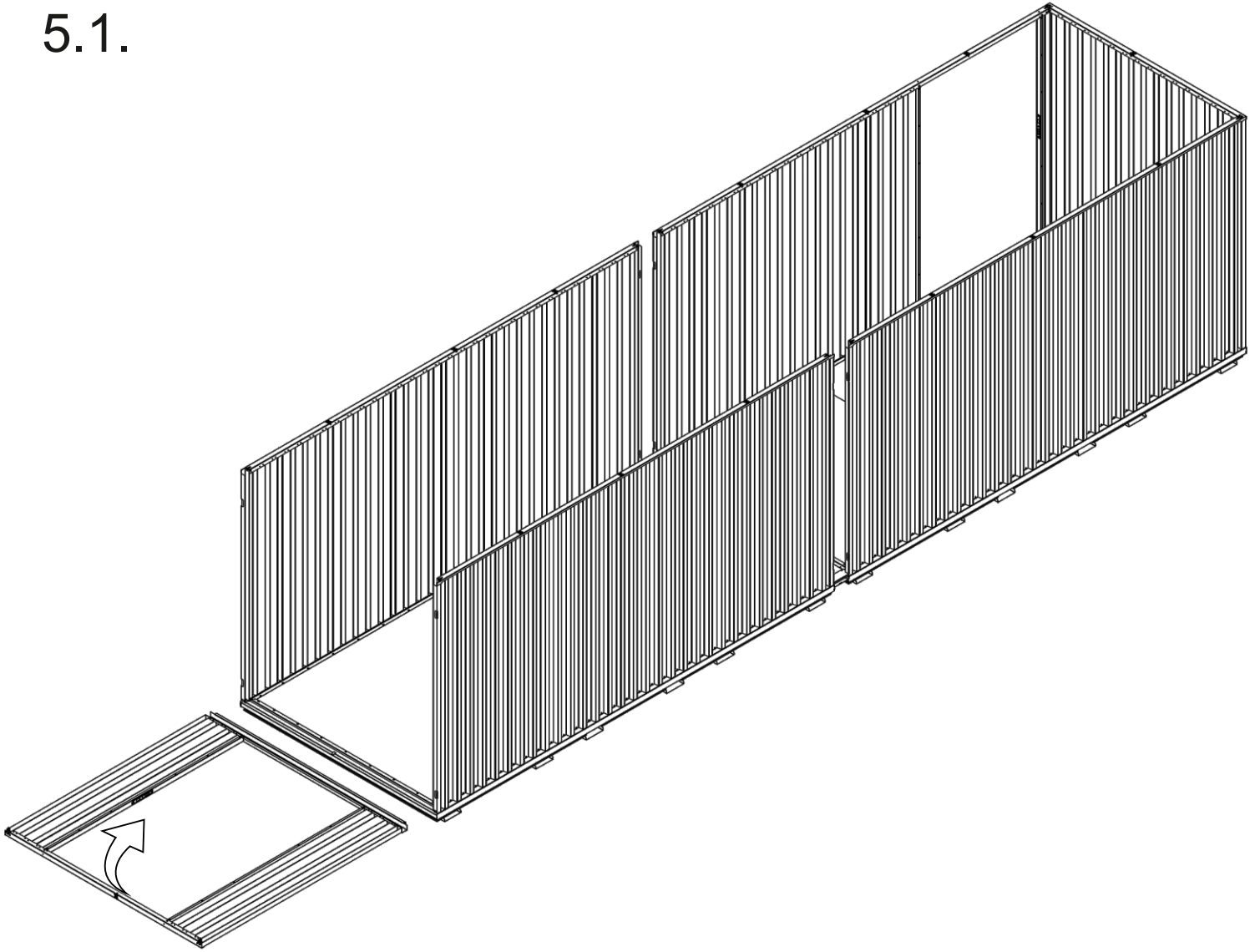

5.2.

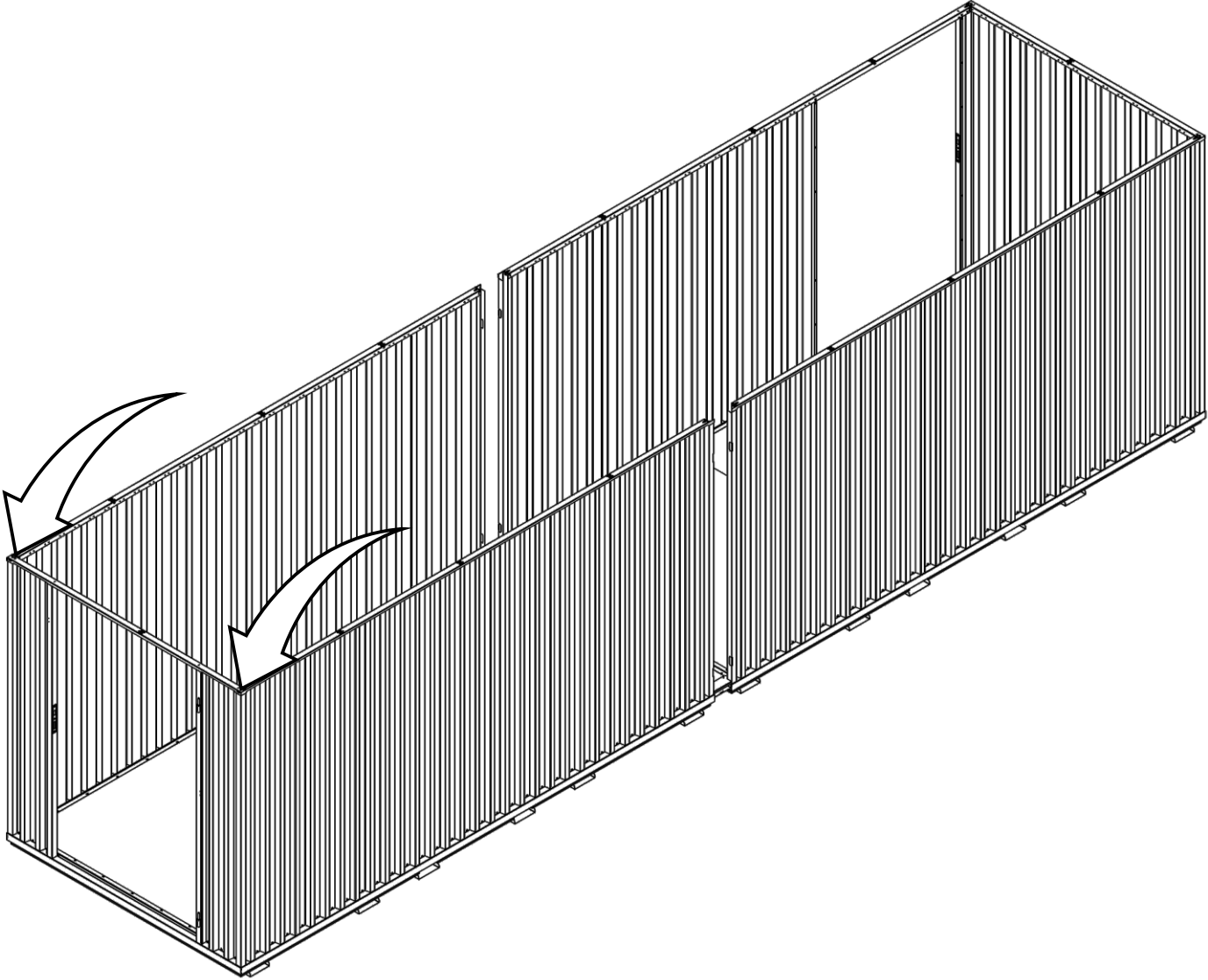
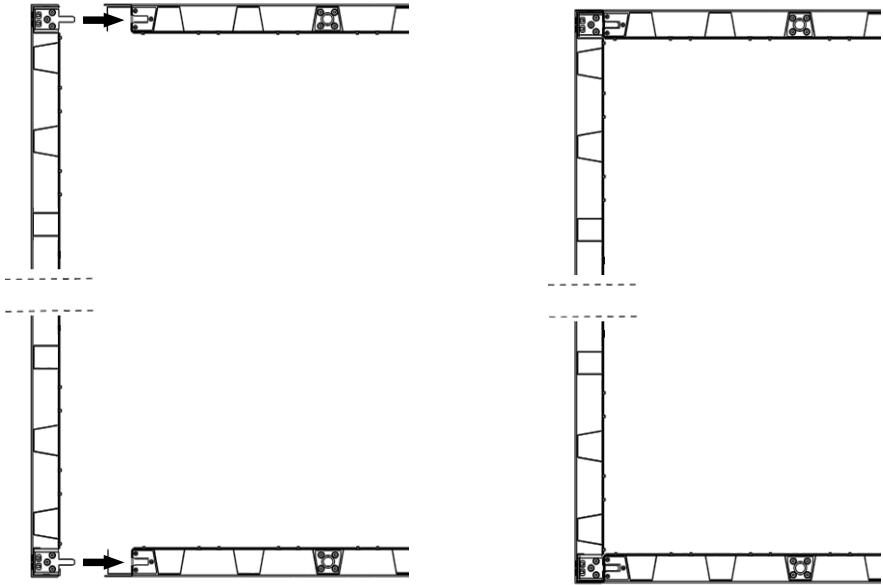

5.3.

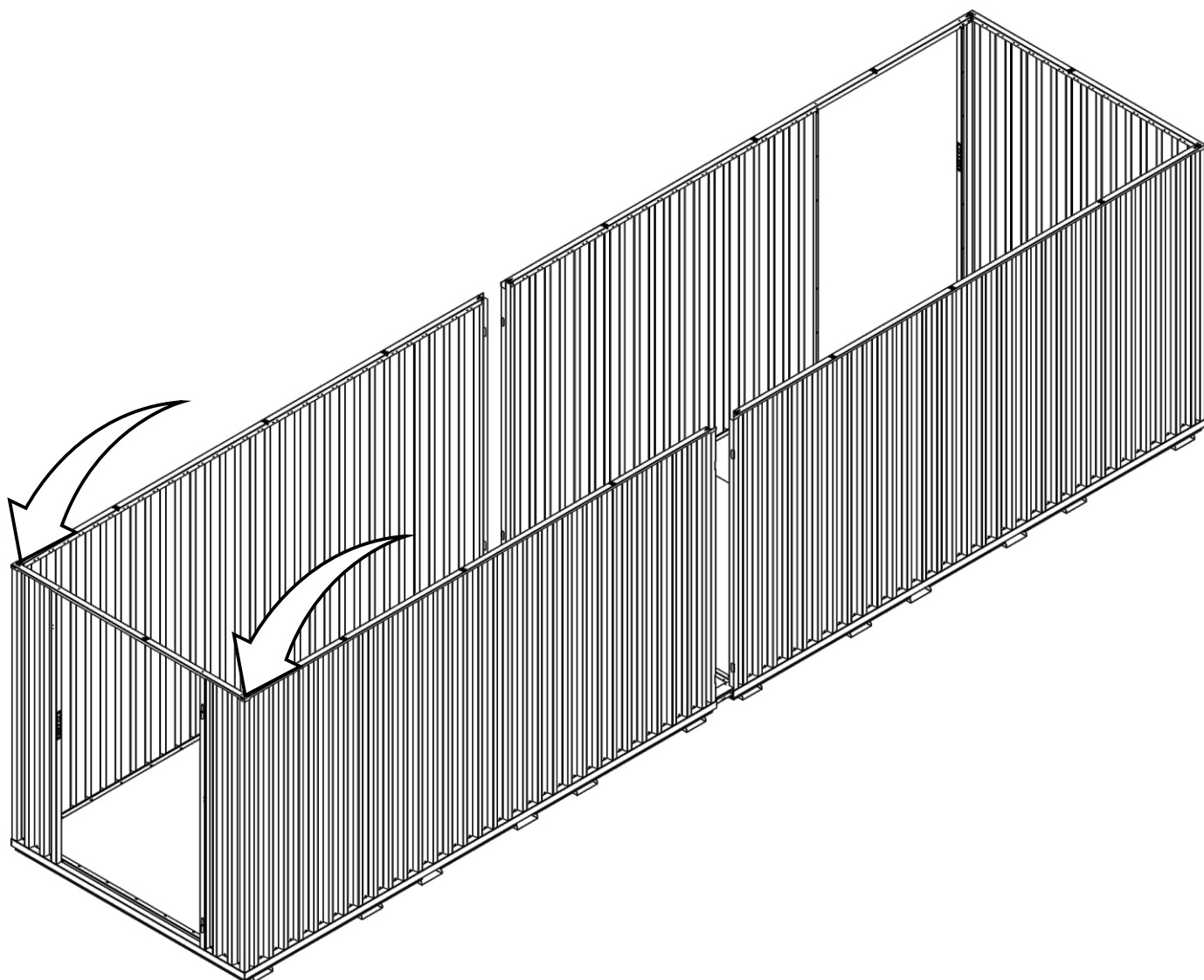
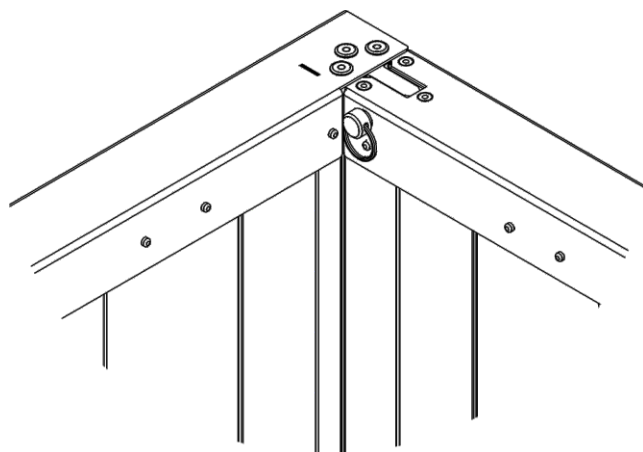
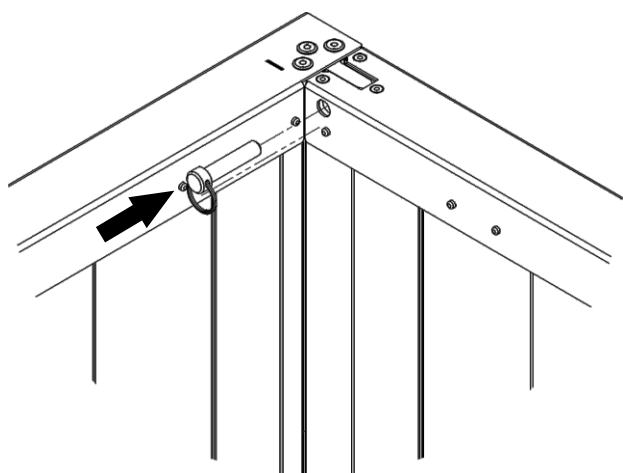

6.1.

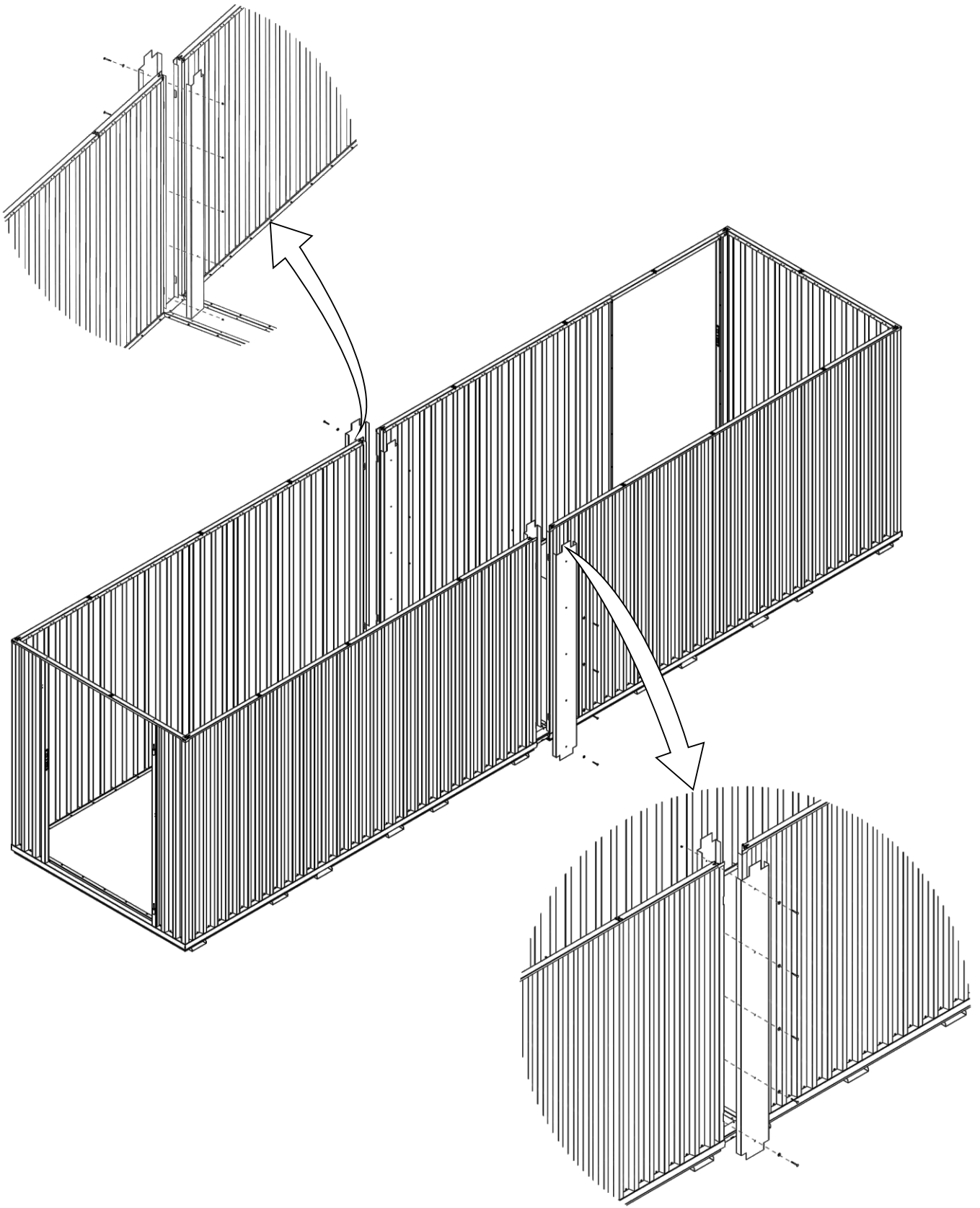

7.1.

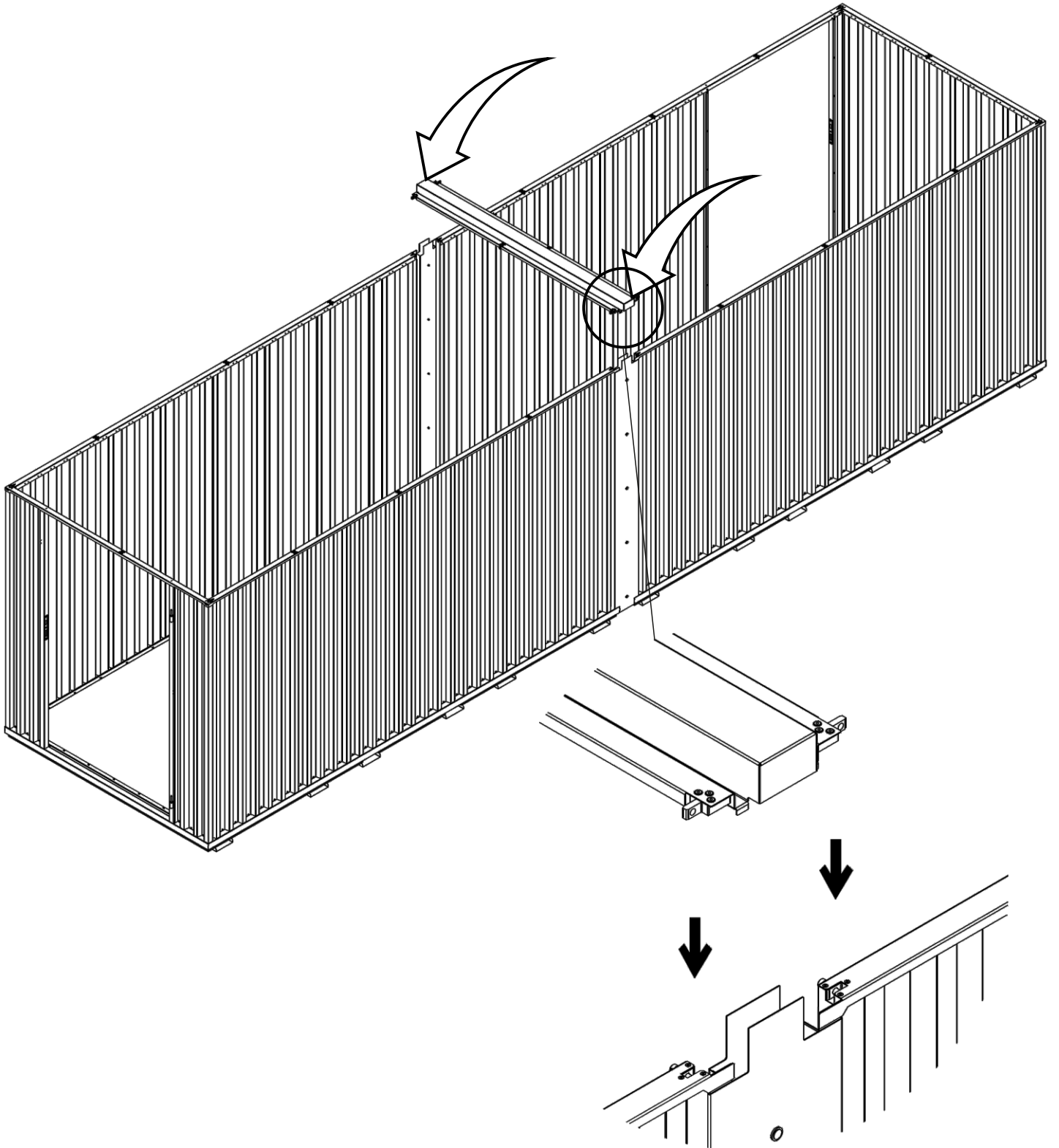

7.2.

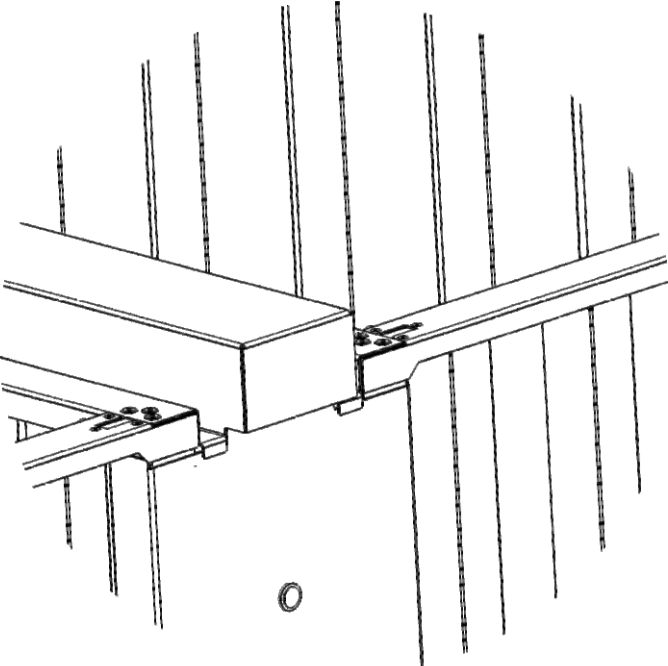
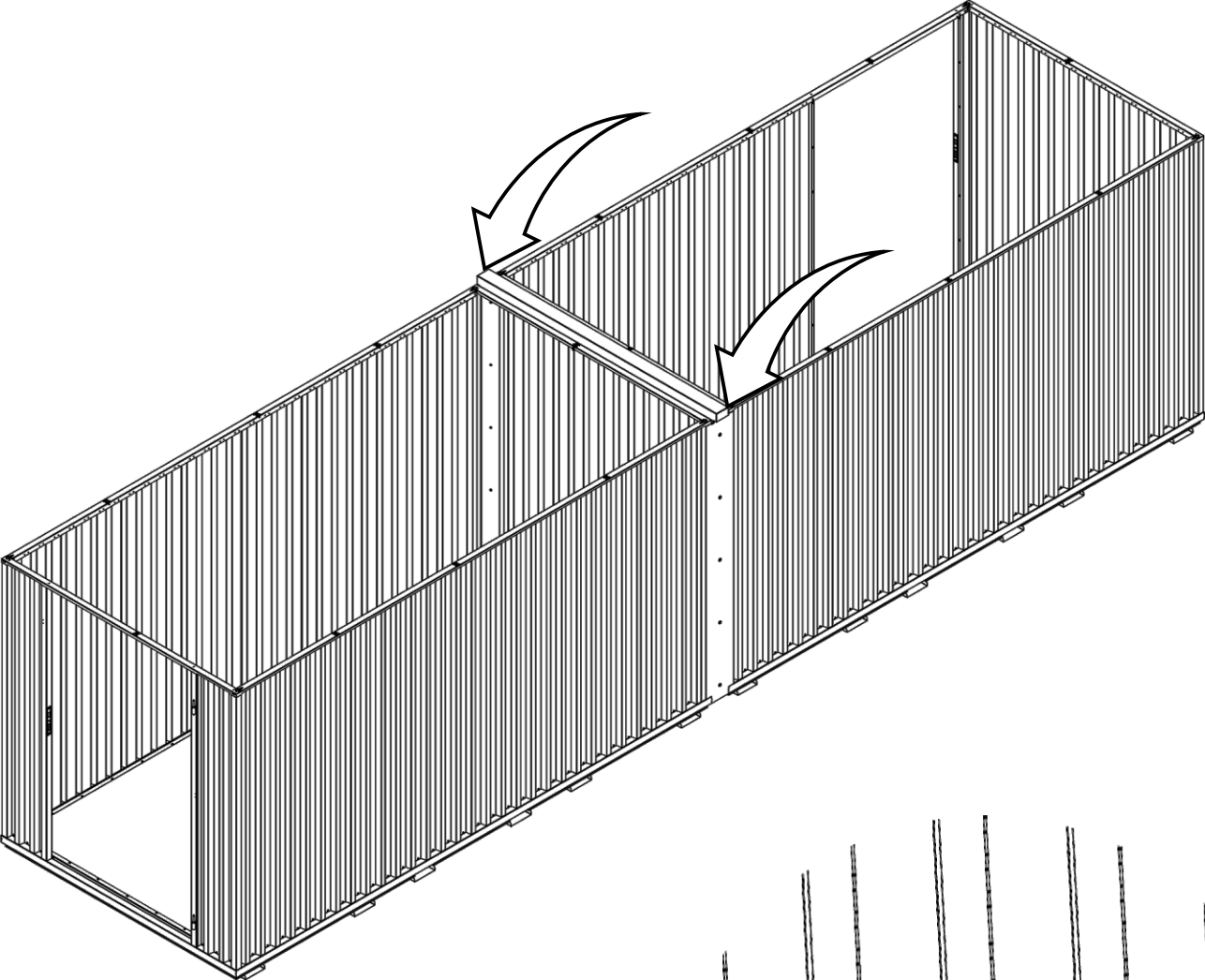



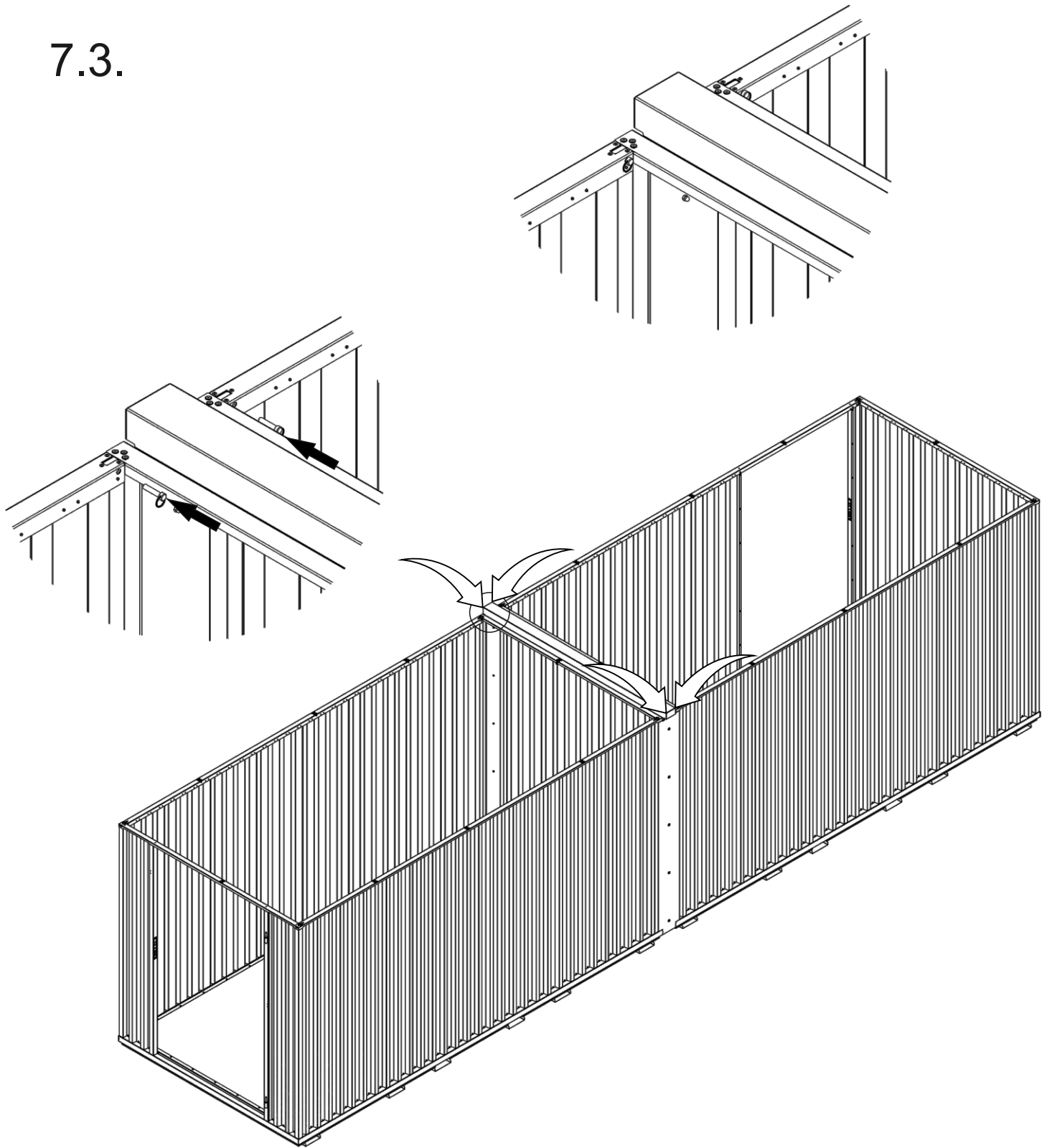

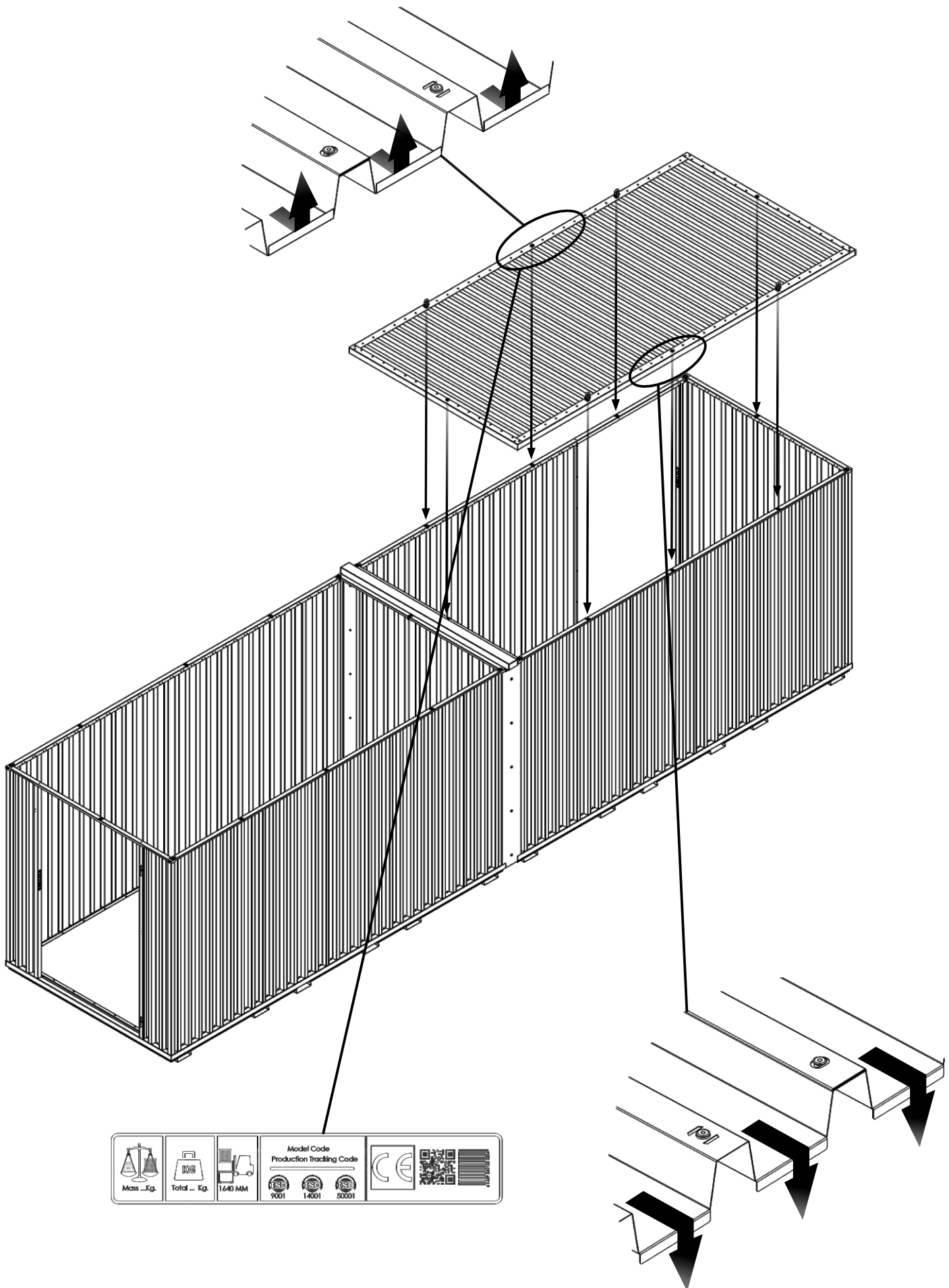

7.3.



8.1.

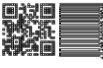

 Mass ...Kg.	 Total ... Kg.	 1640 MM	Model Code Production Tracking Code   	 
--	--	--	---	---

8.2.

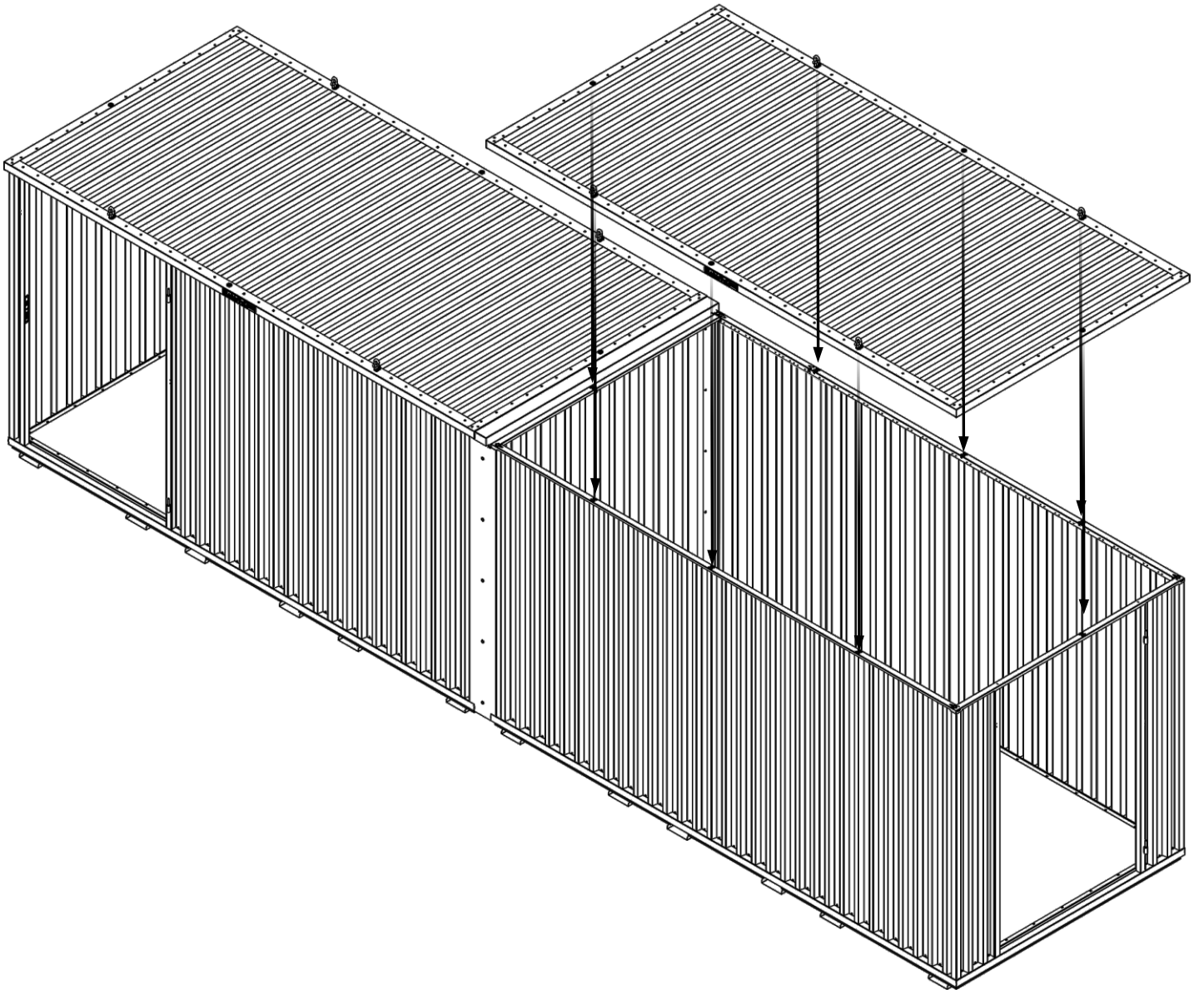

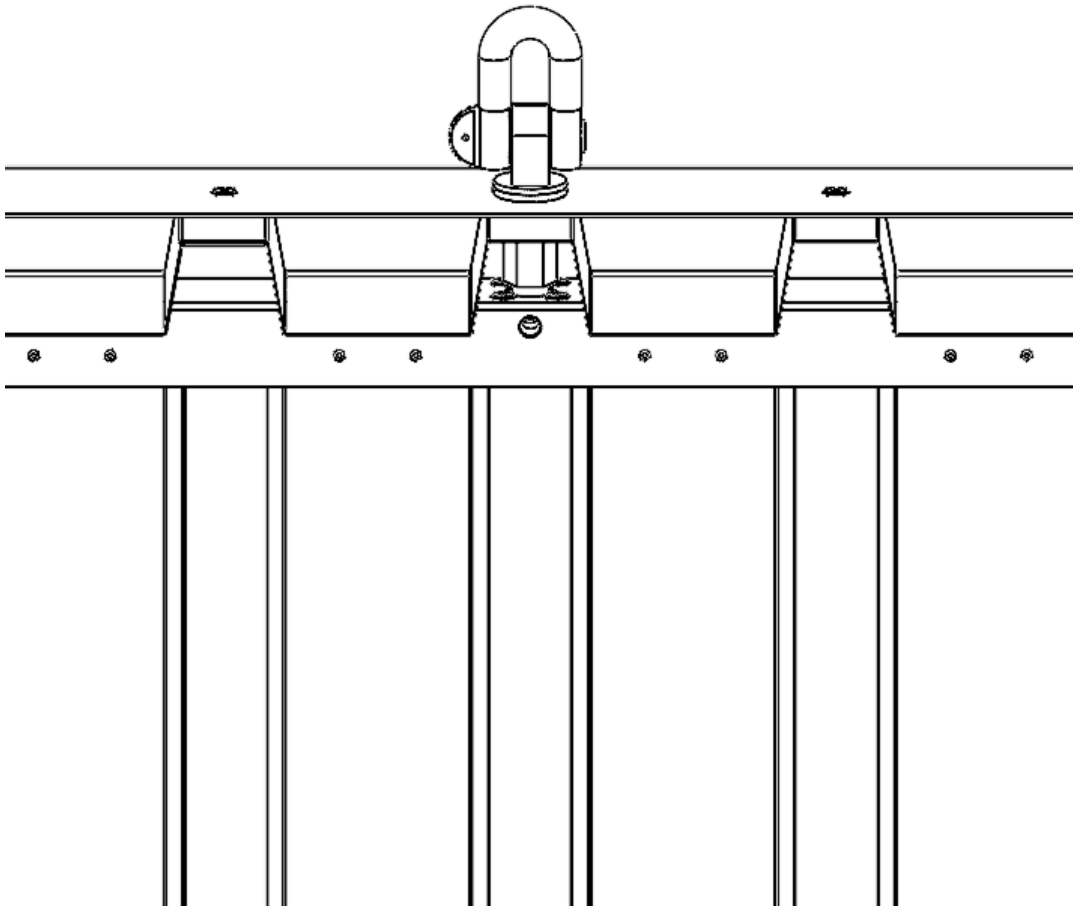
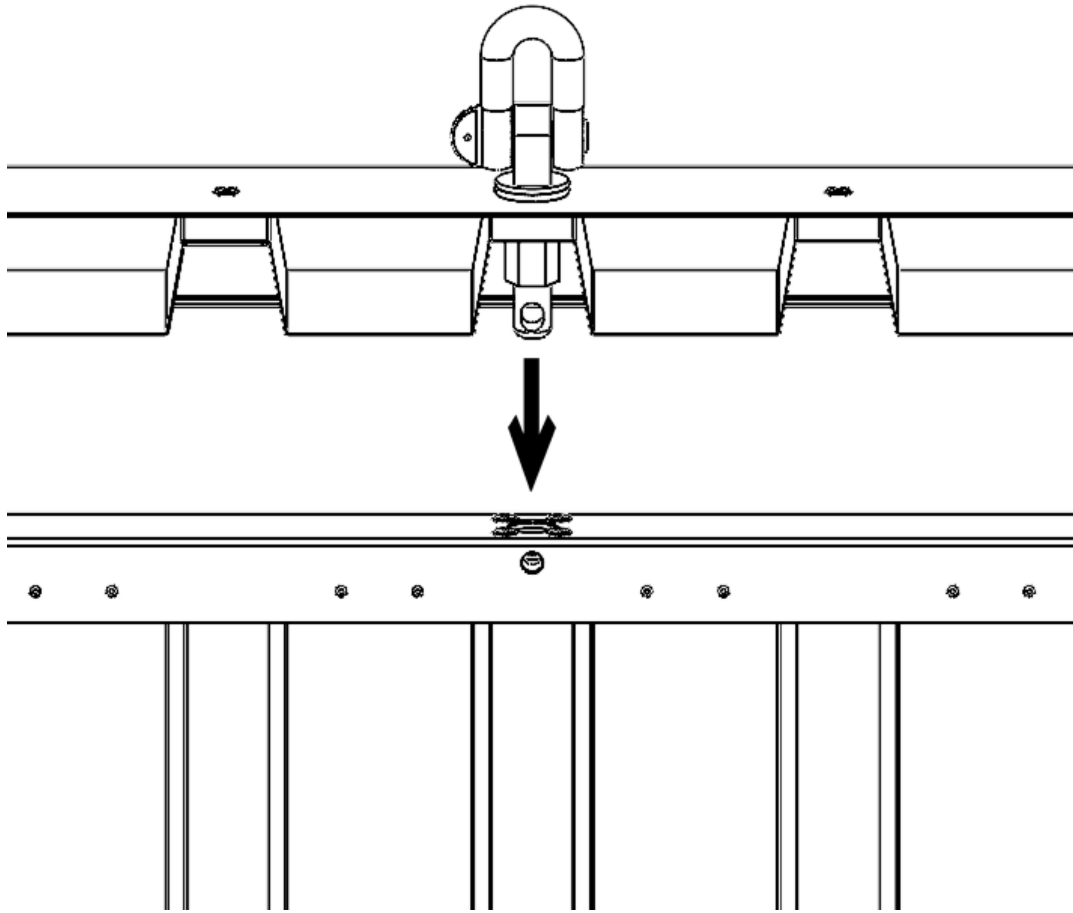

8.3.

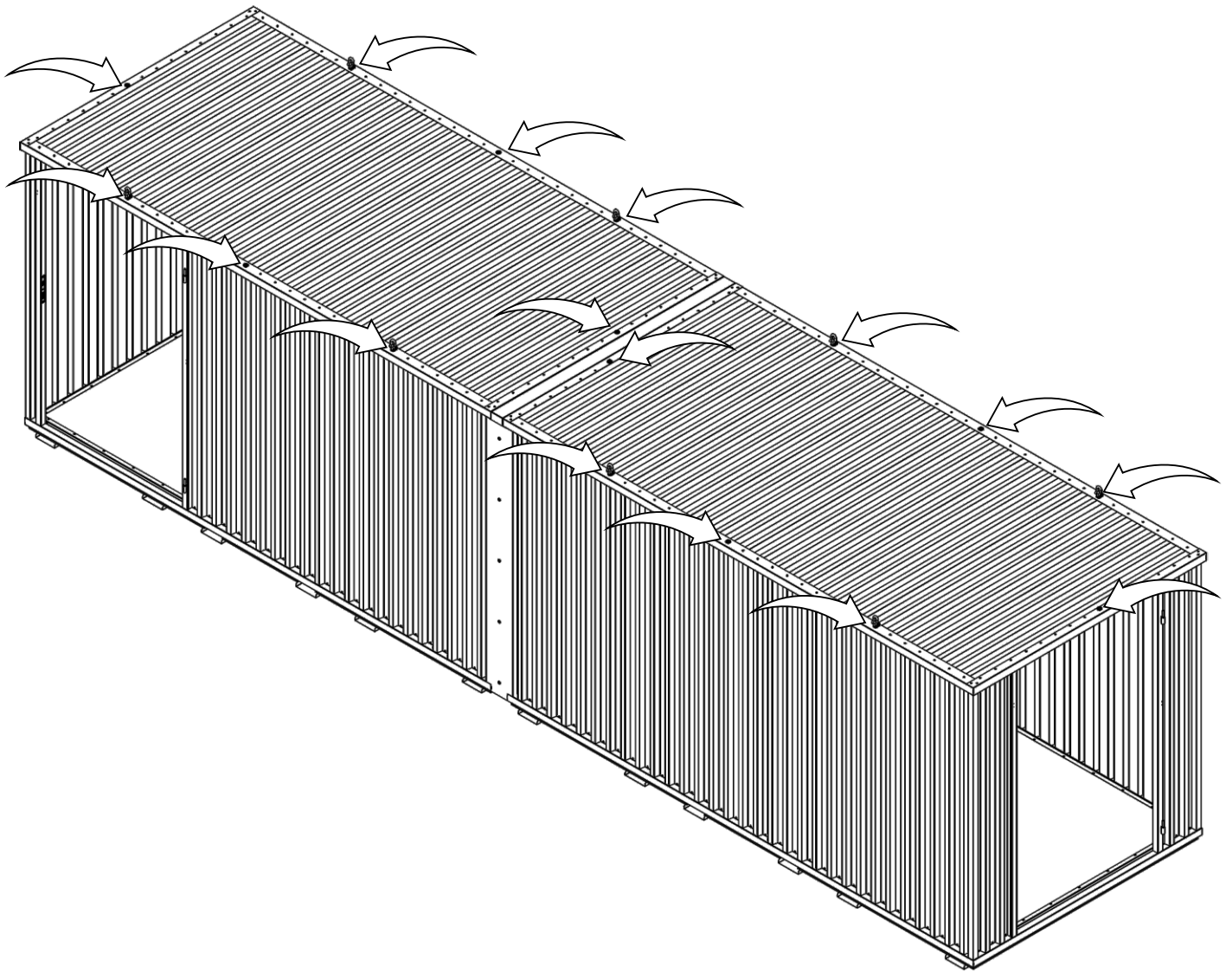

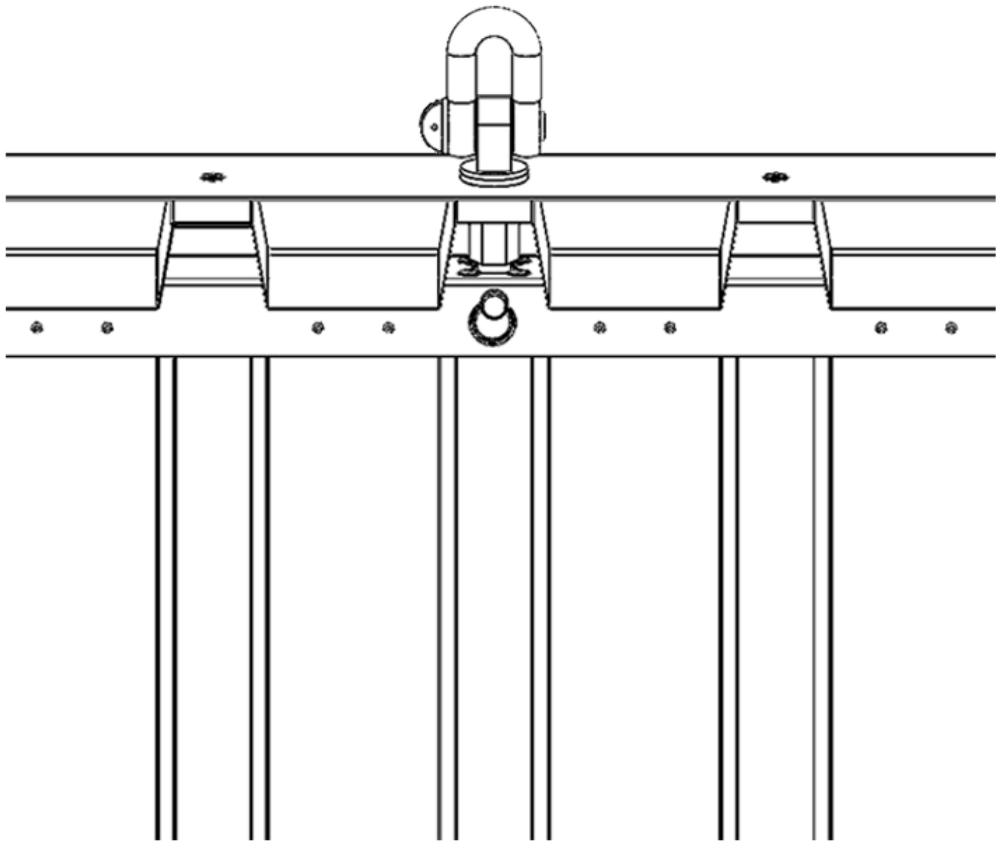
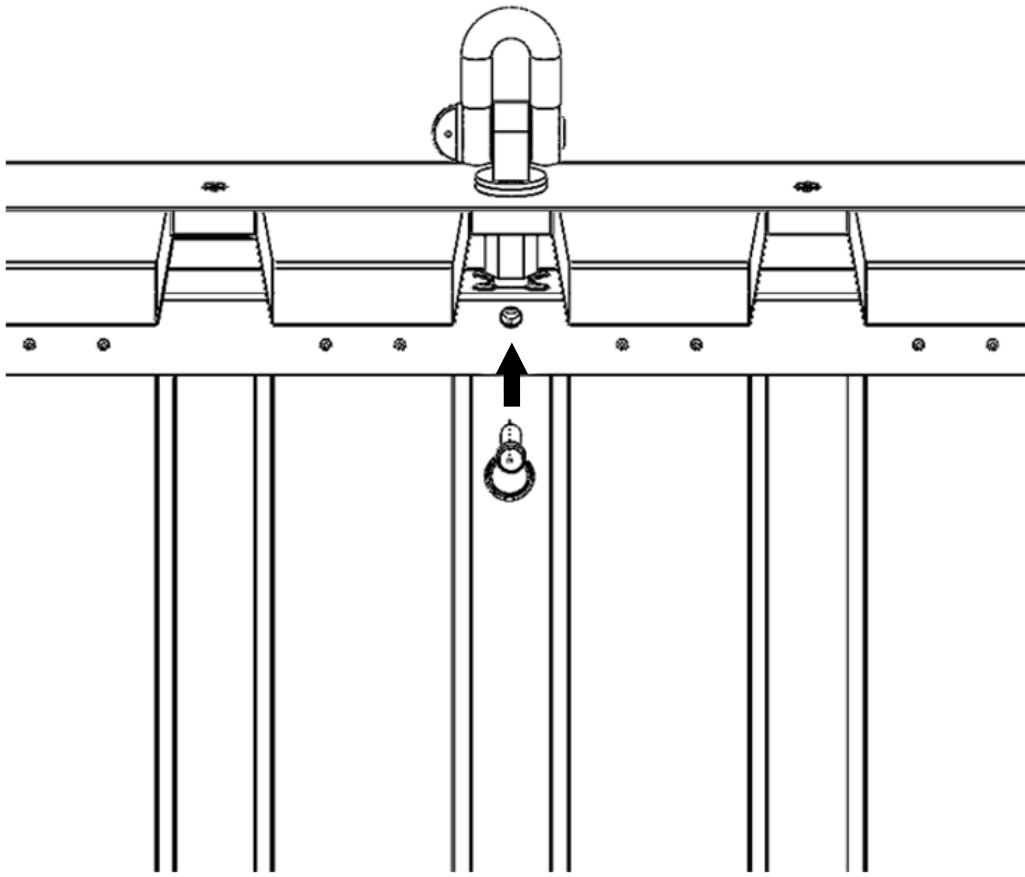

9.1.

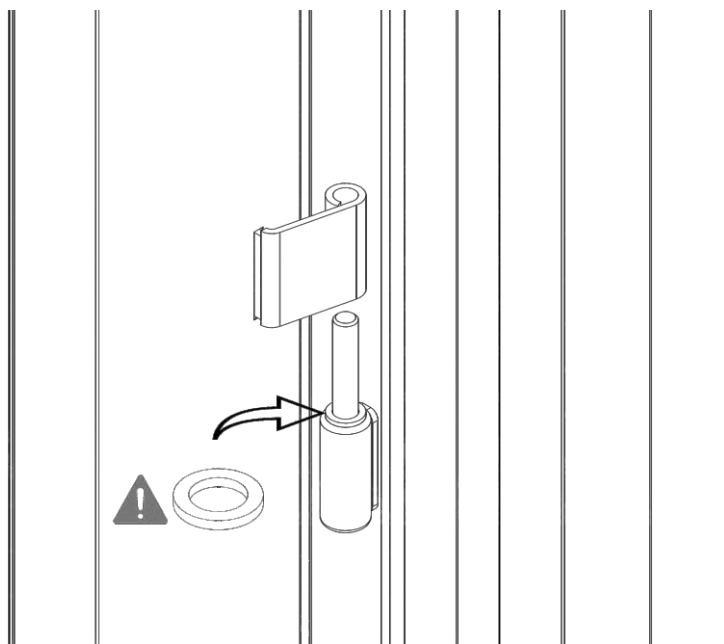
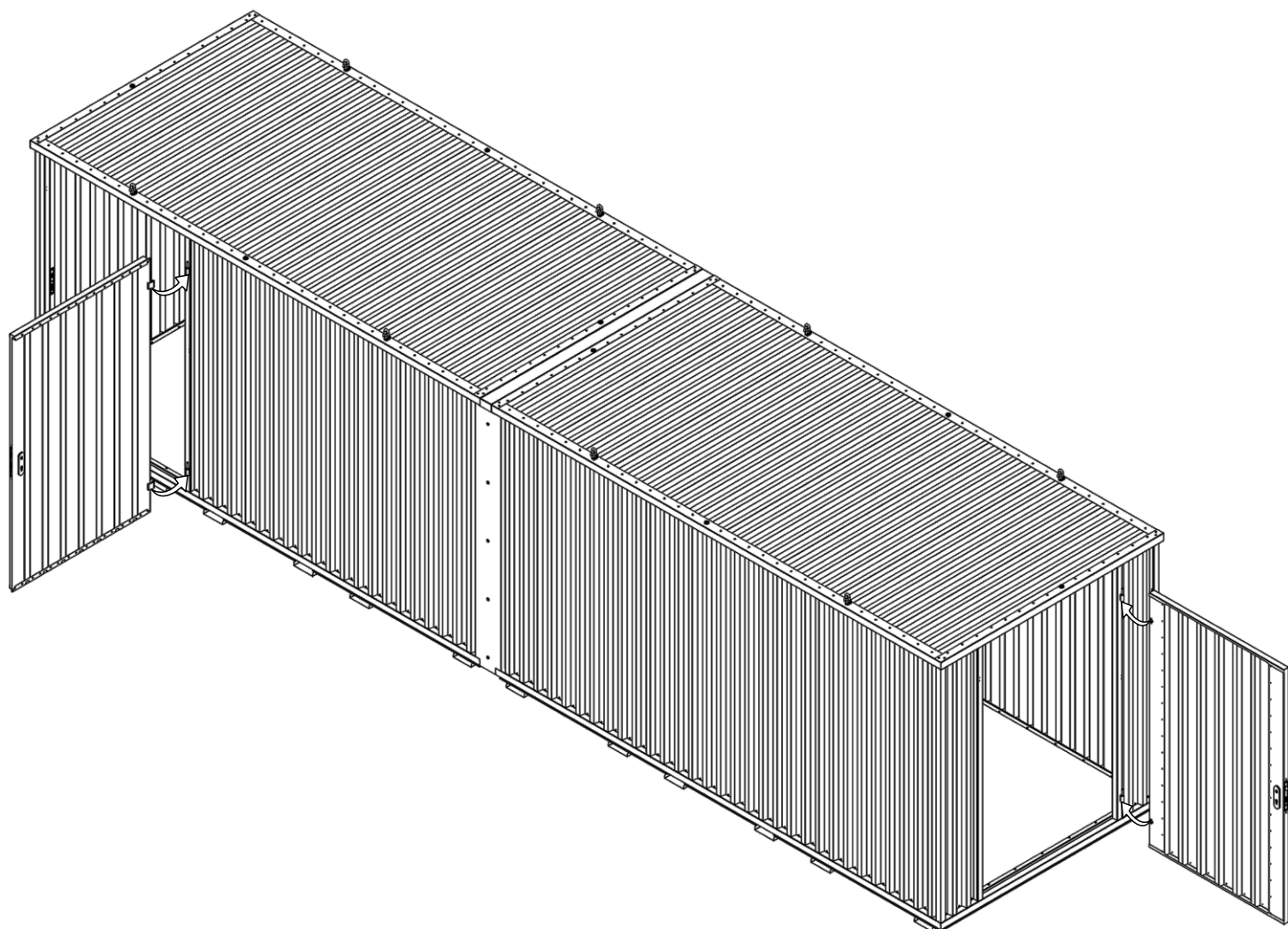

9.2.

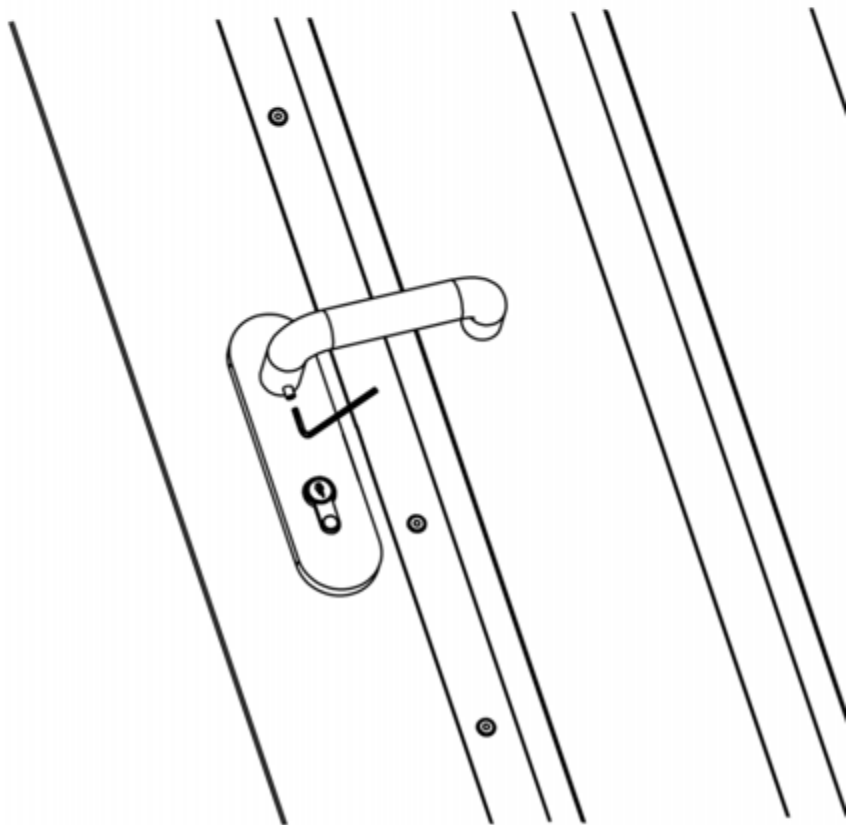
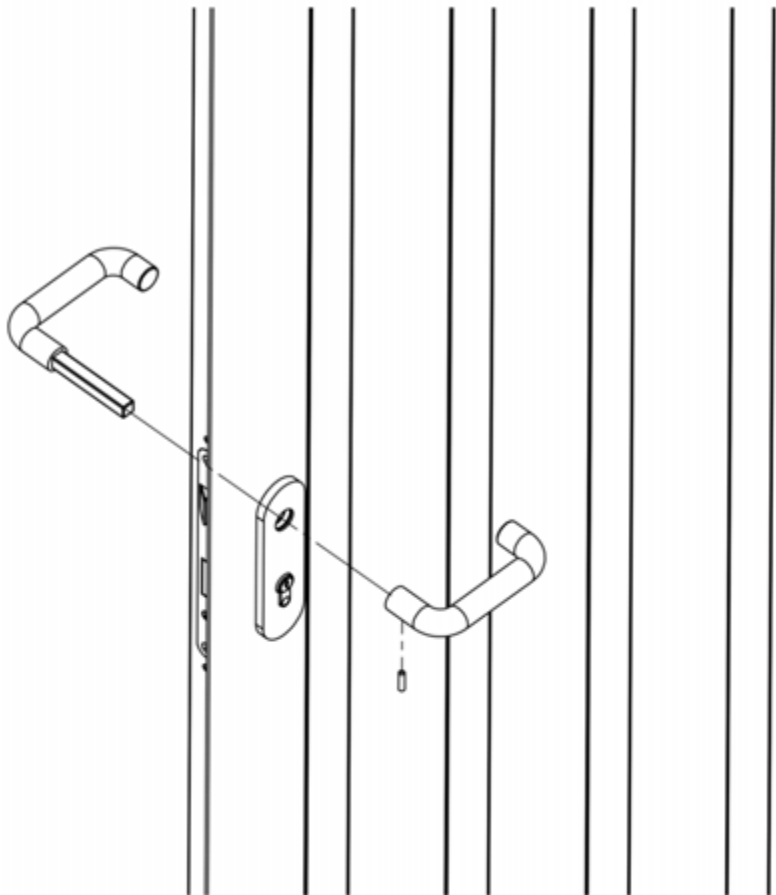

10.1.

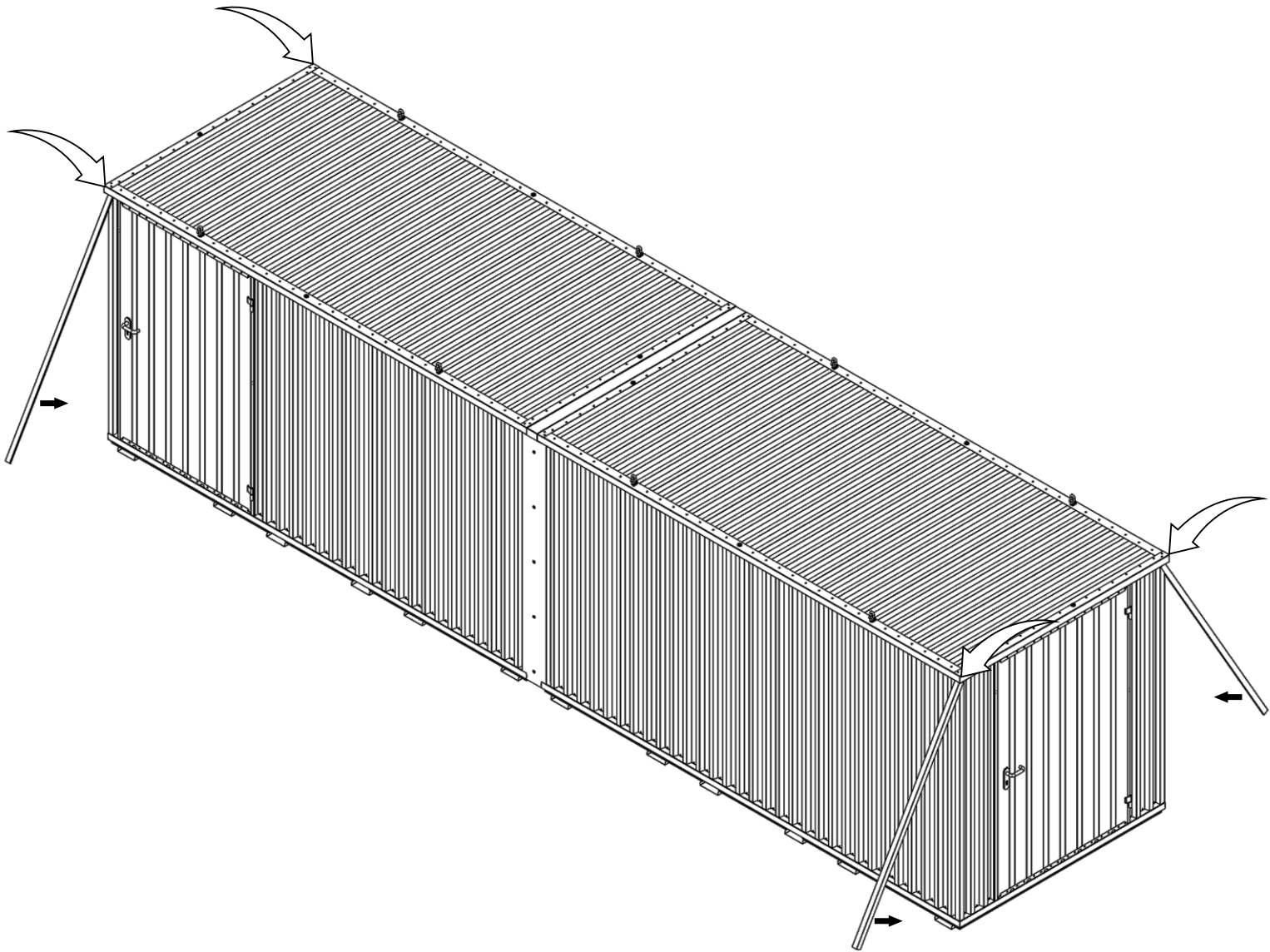

11.1.

