

PRODUCT CODE:50.110.440.320

prefabase
Quick Build Solutions

Instructions and User Guide

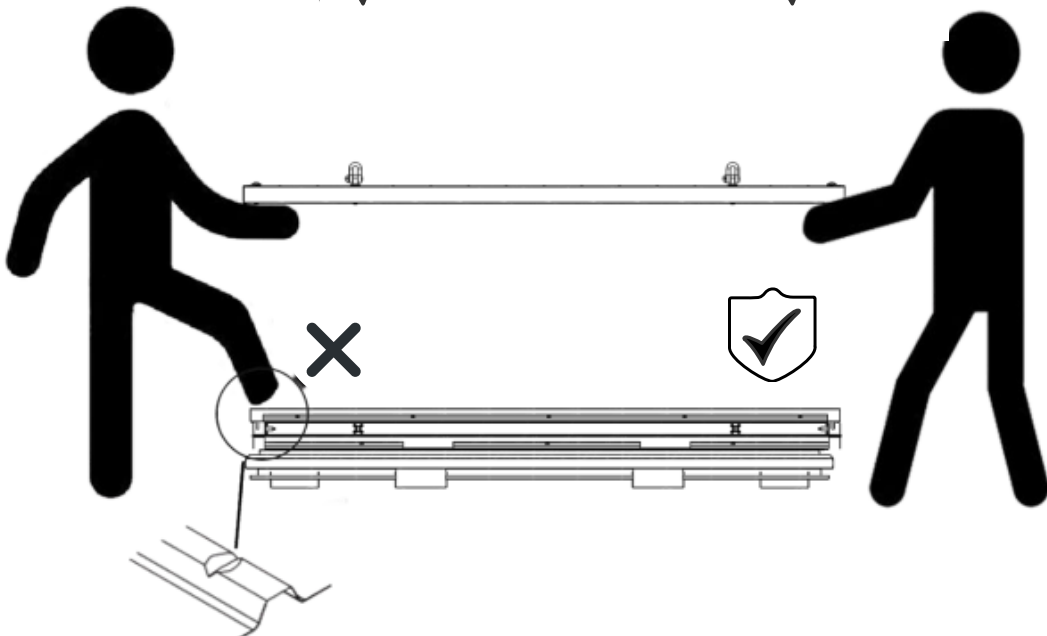
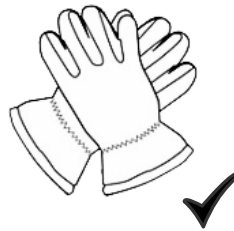
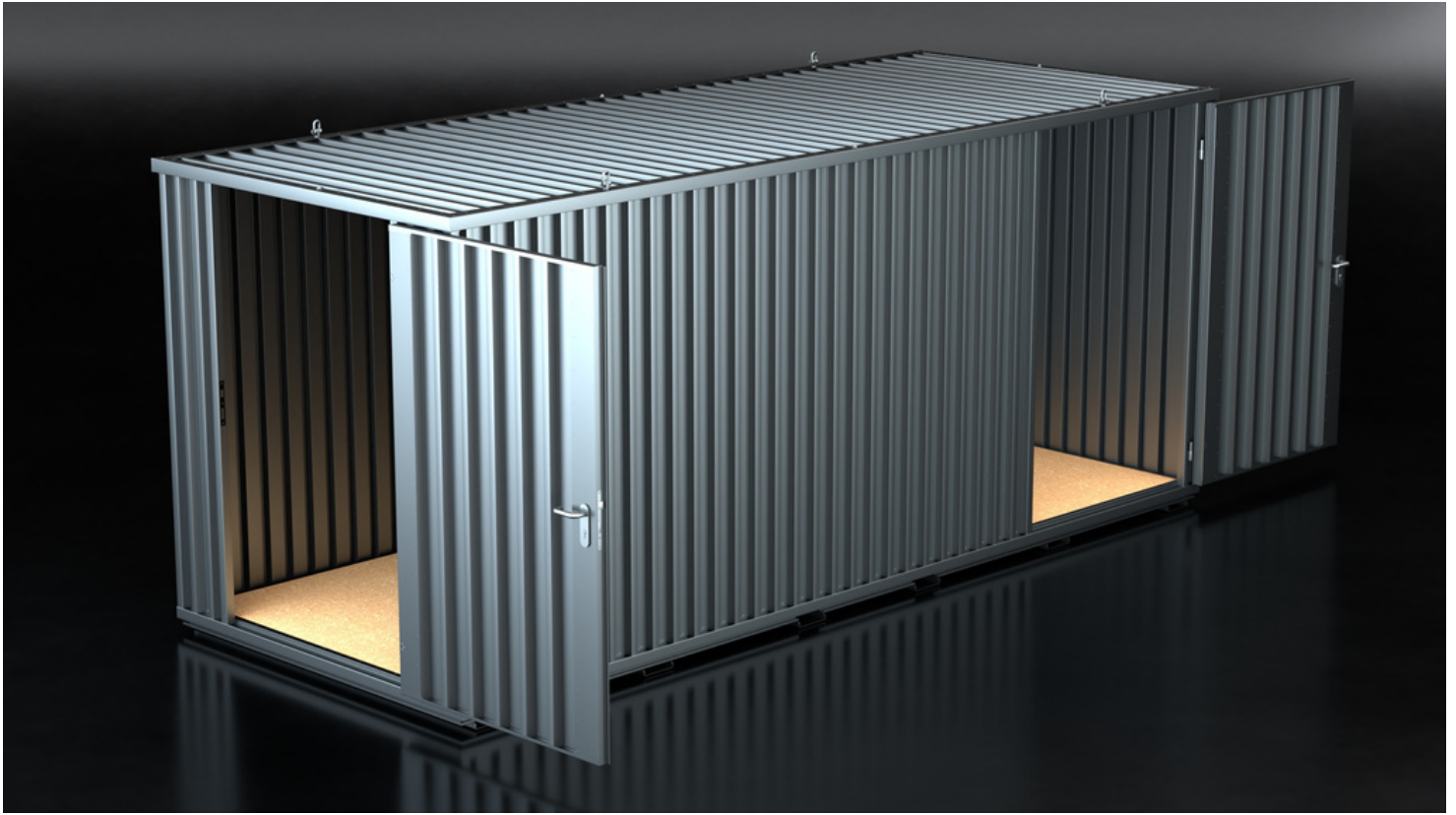

50.0110

1x

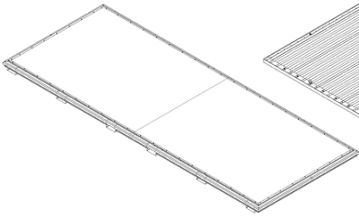

50.0510

1x

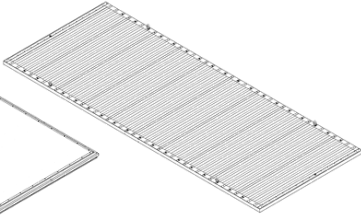

50.0410

1x

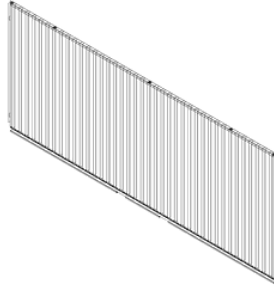

50.0440

1x

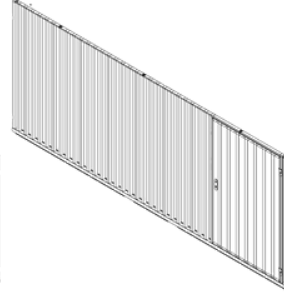

0310

1x

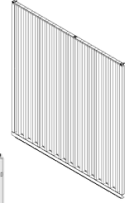

0320

1x



61.101

4x



12x

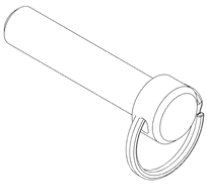

2x

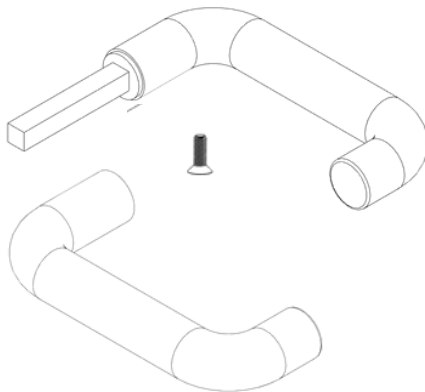

1x

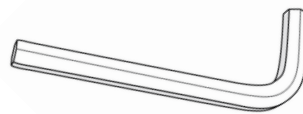

2x



1

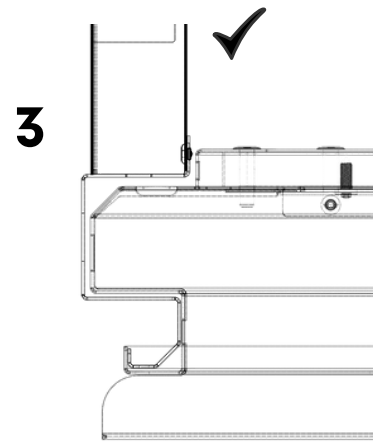
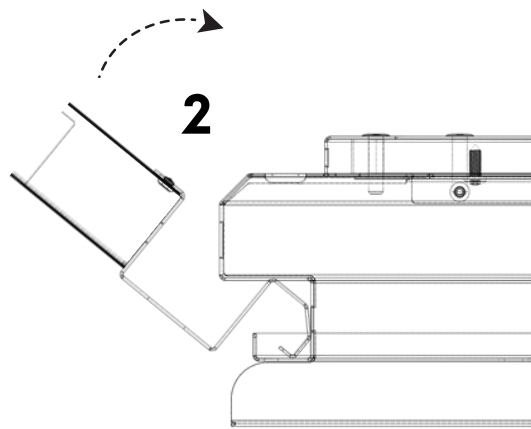
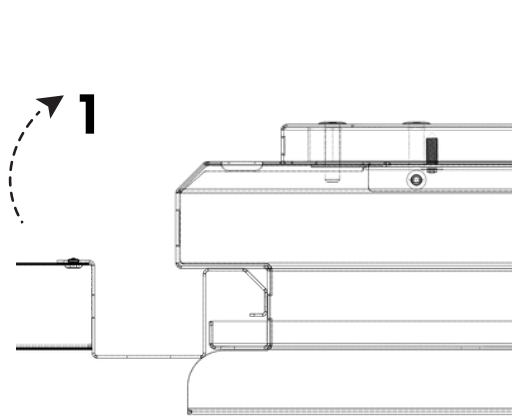
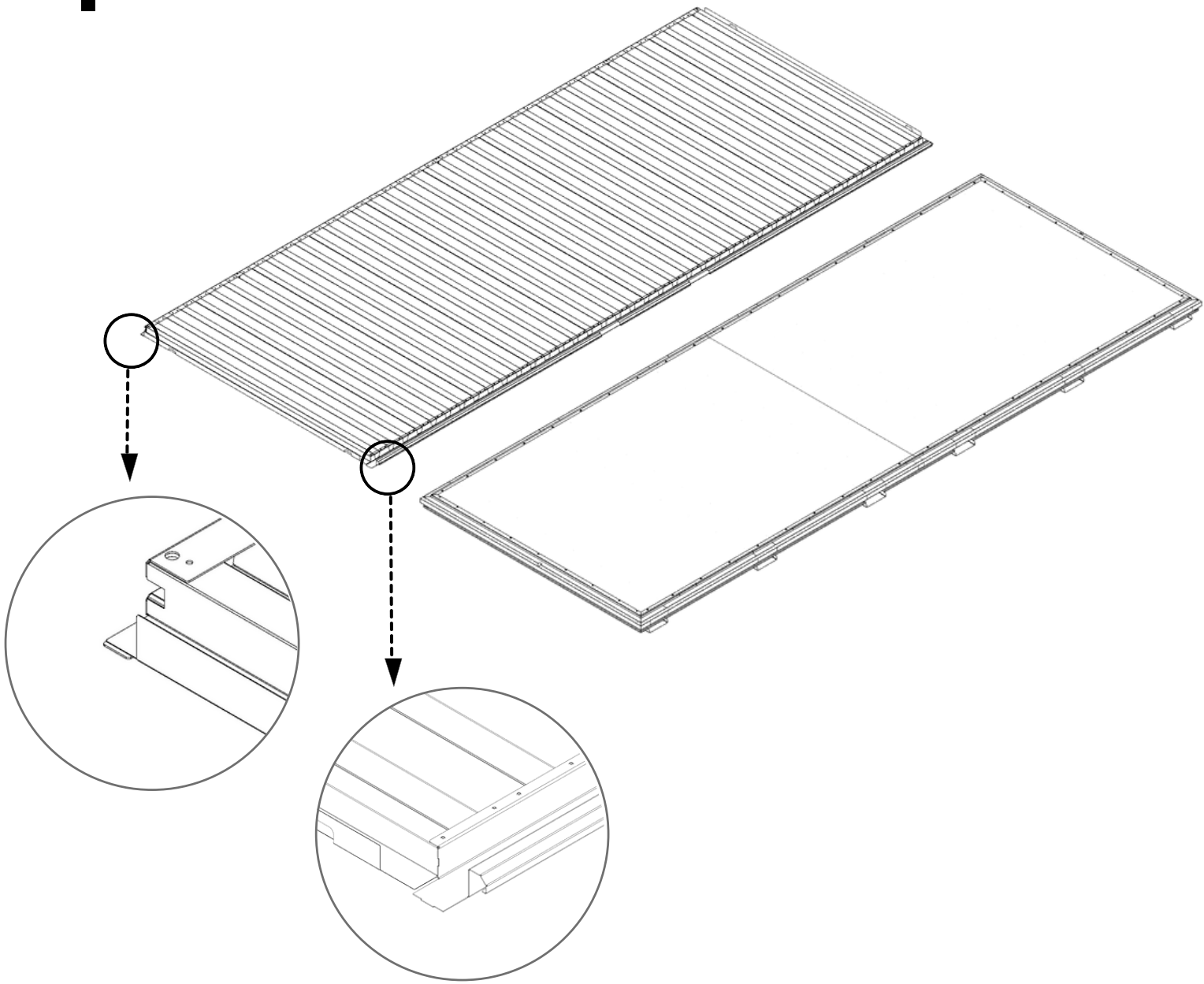

2

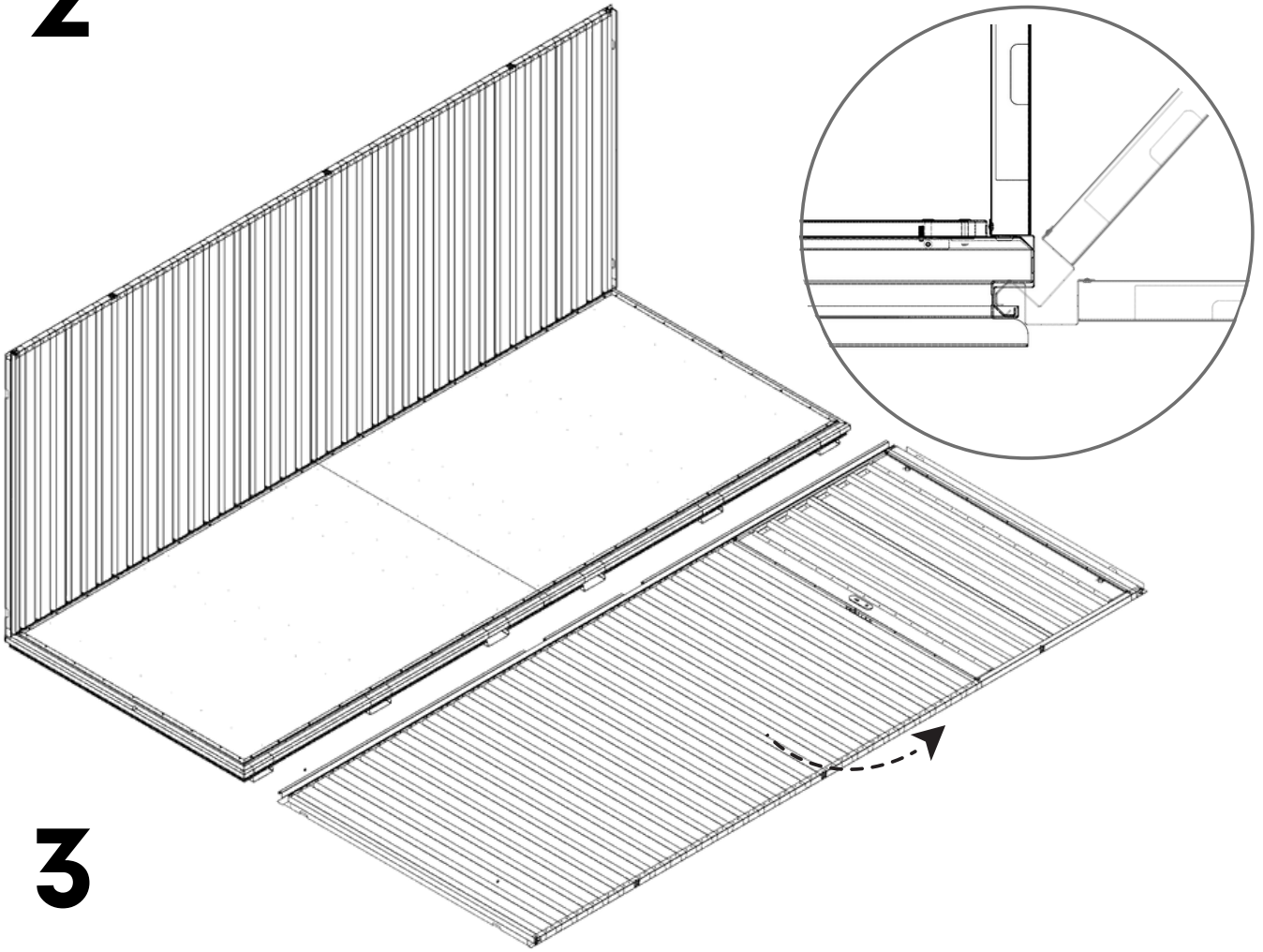

3

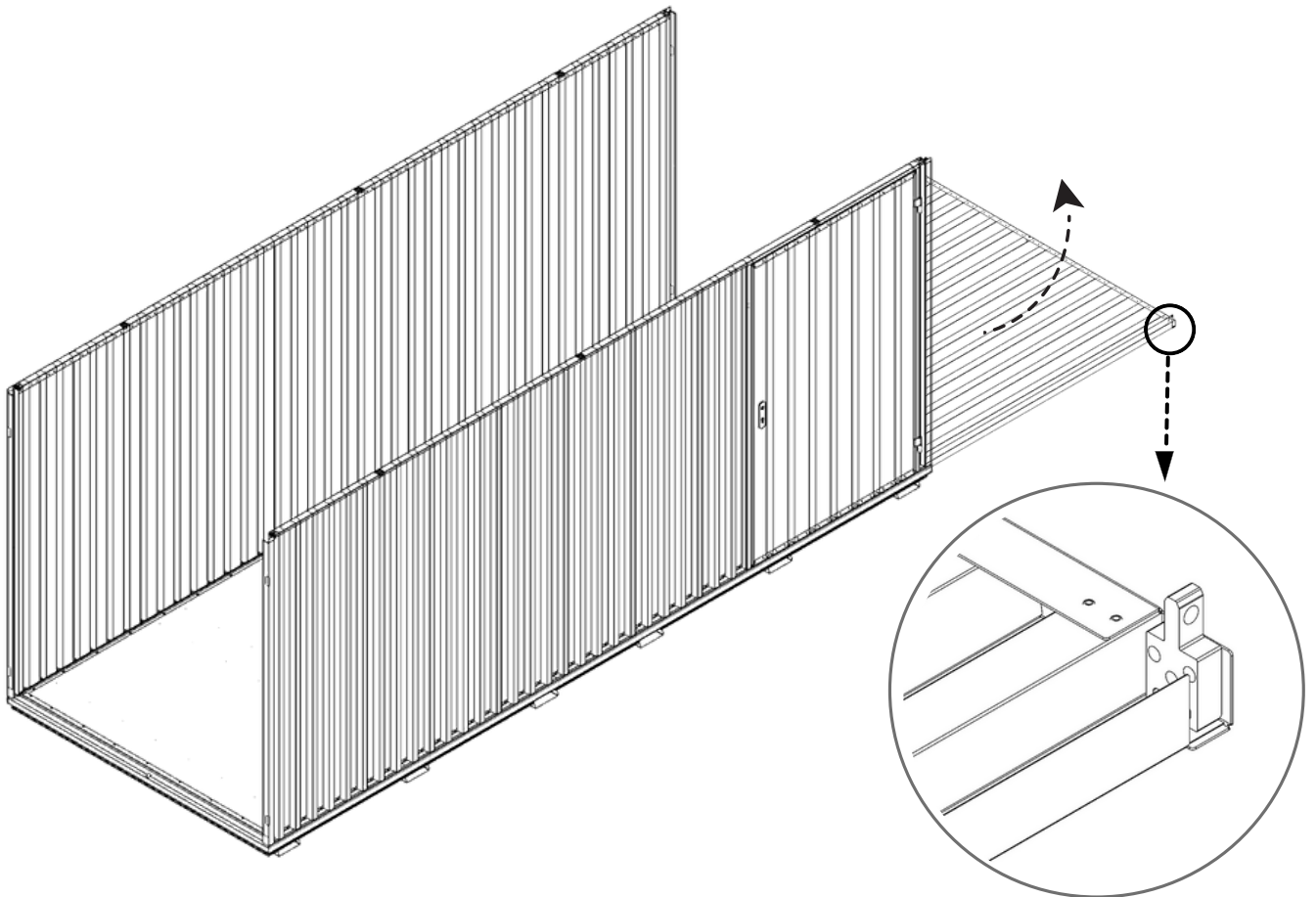

3.1

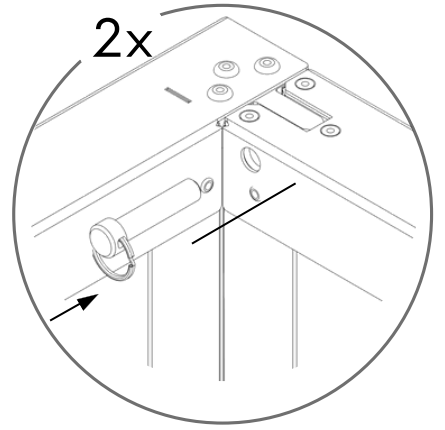
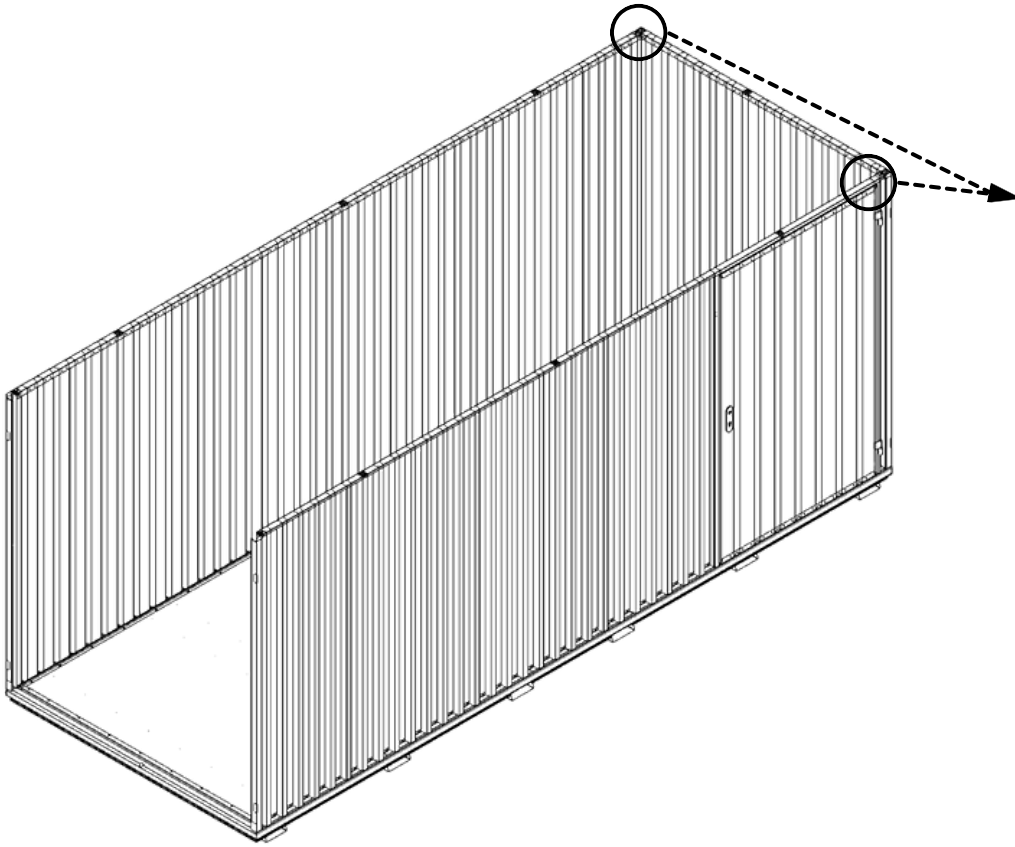



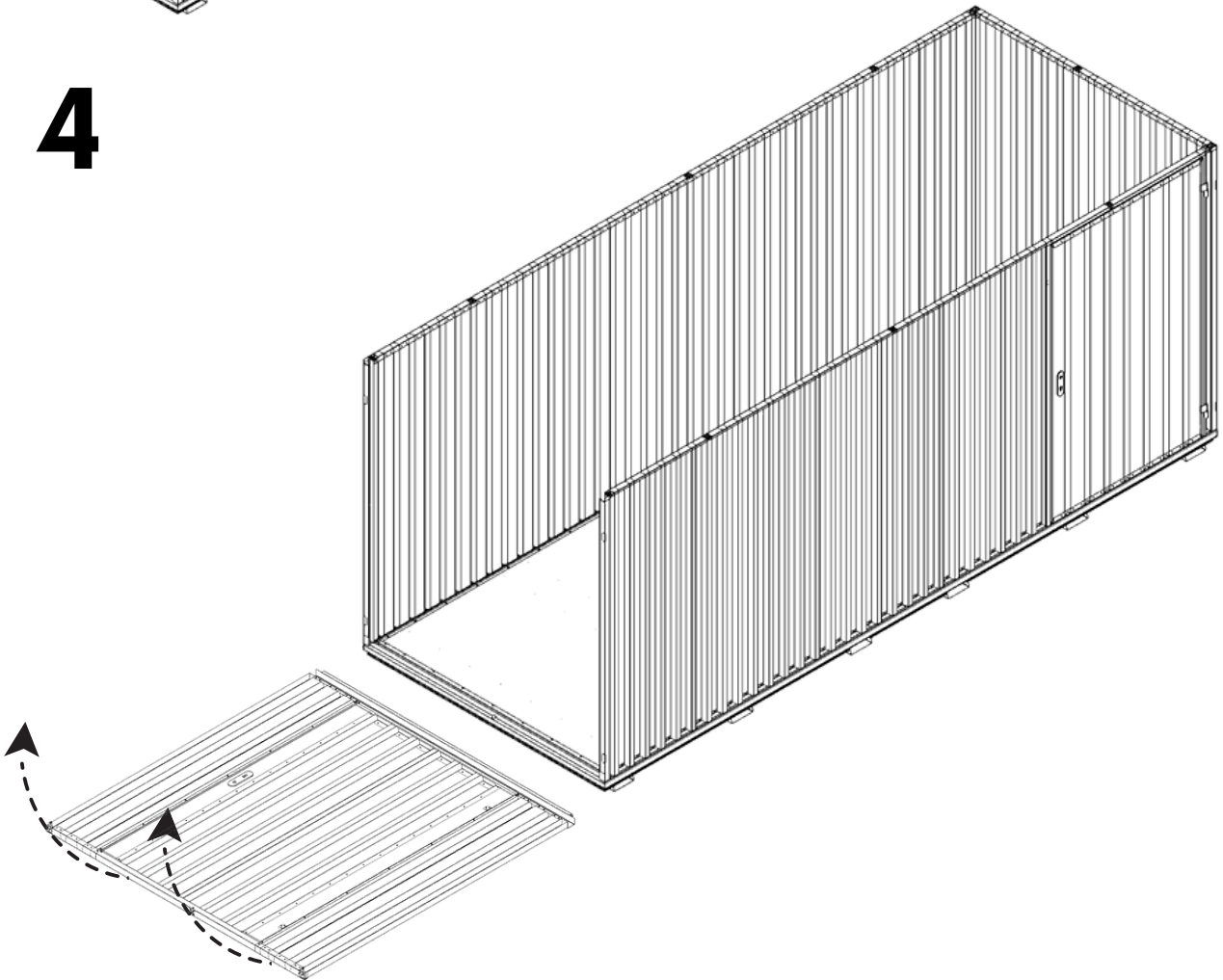



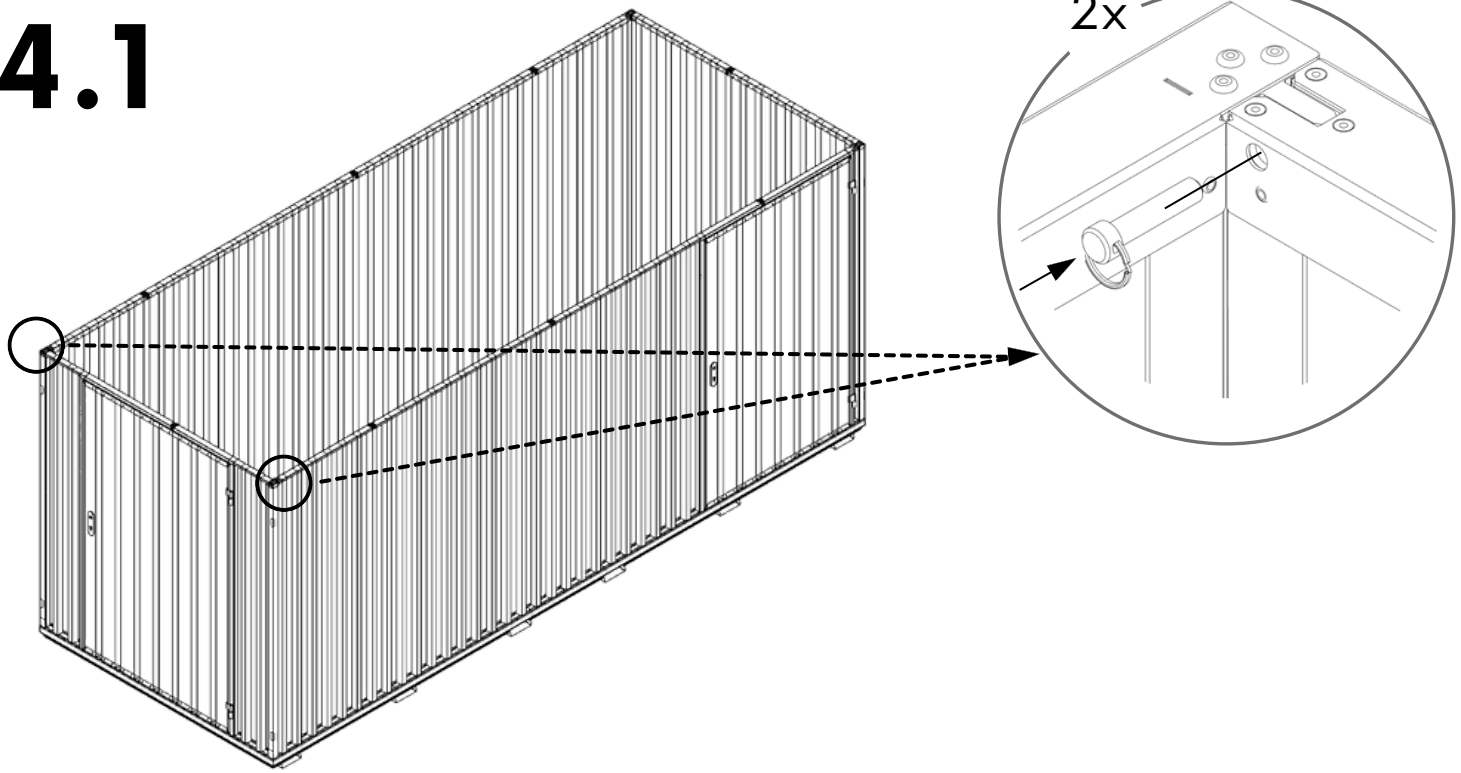

4



4.1



 508 KG	 1640 MM	Model Code: 50.110.440.320 Production Tracking Code:/X09.1.50.440.320  9001  14001  50001	 	
---	--	---	---	---

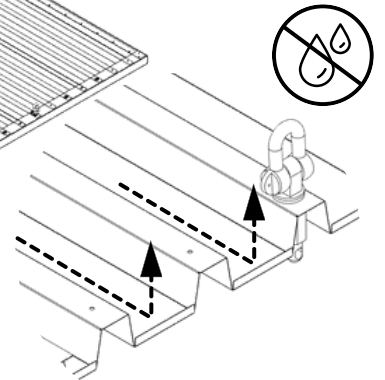
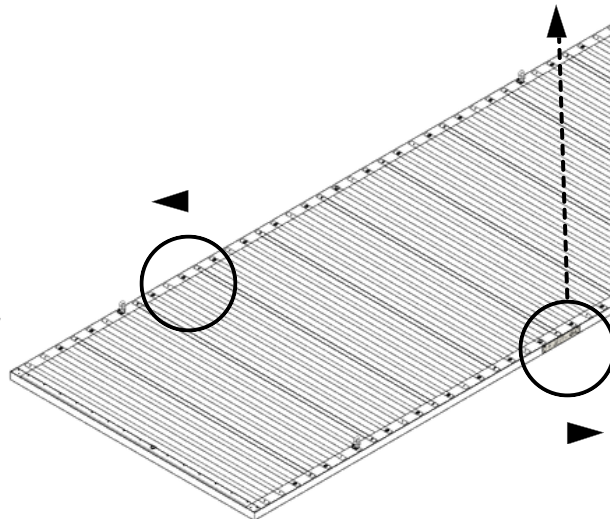
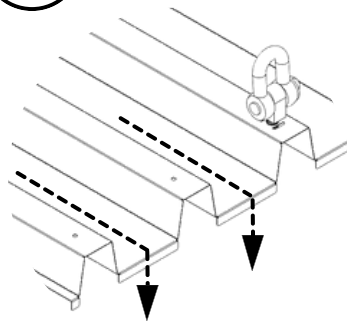

5

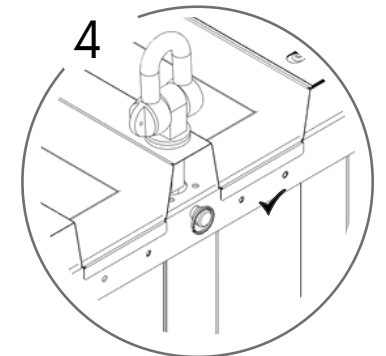
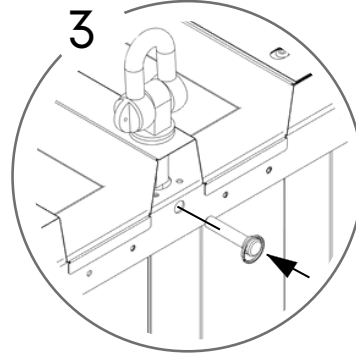
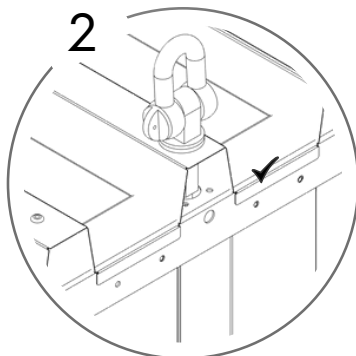
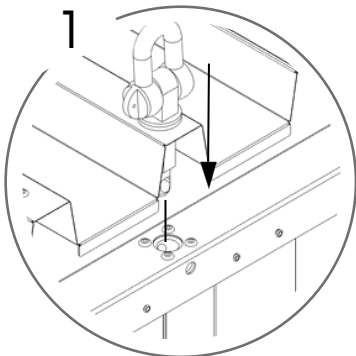
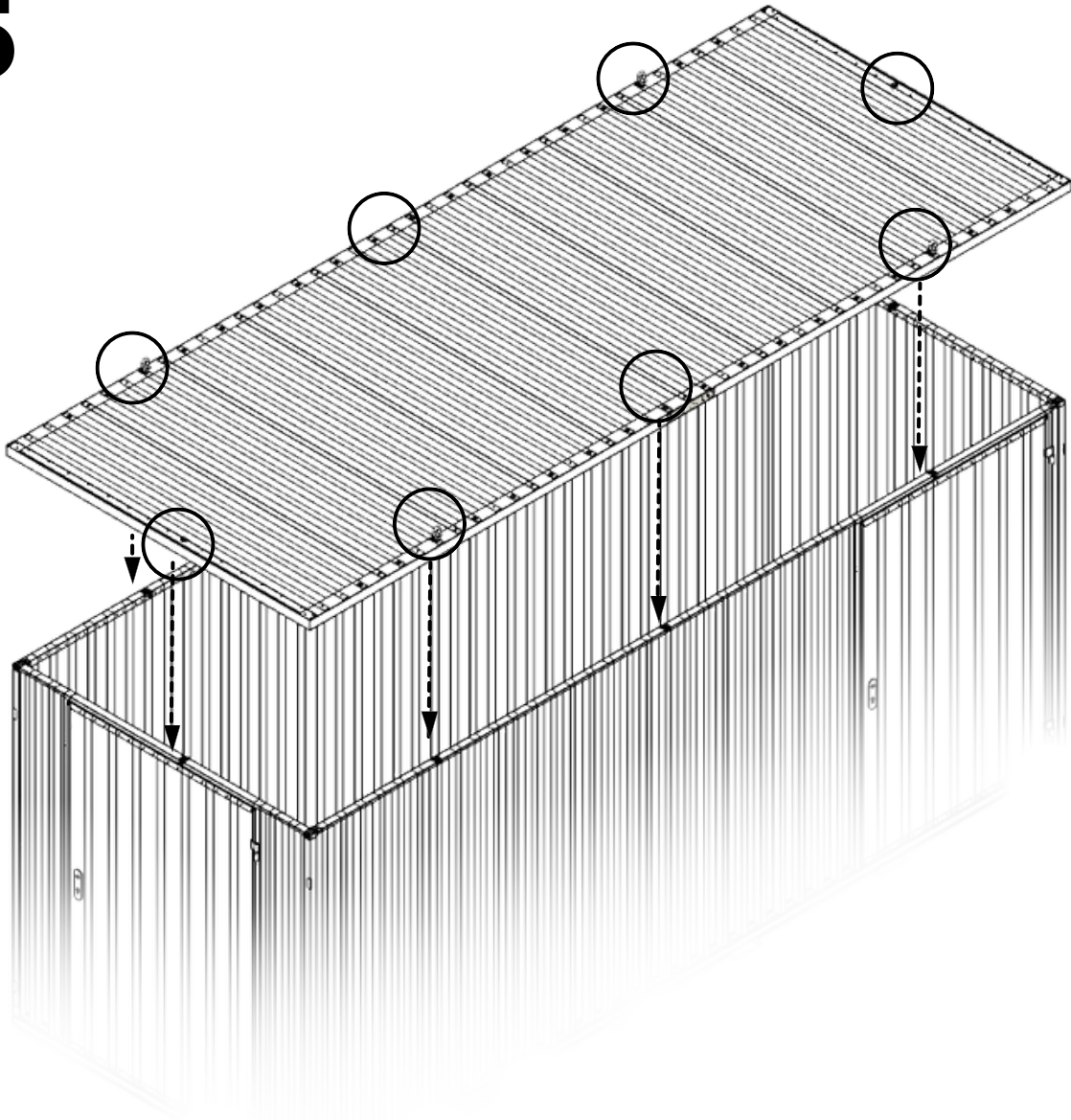

6

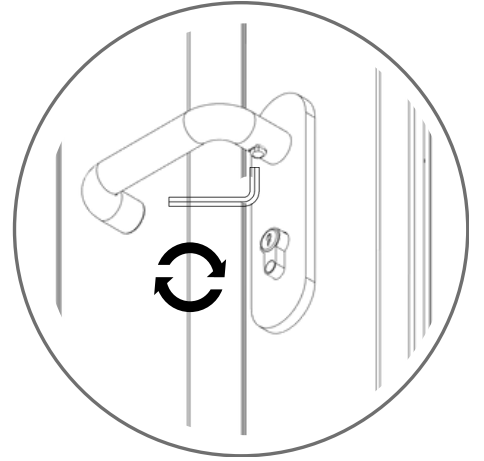
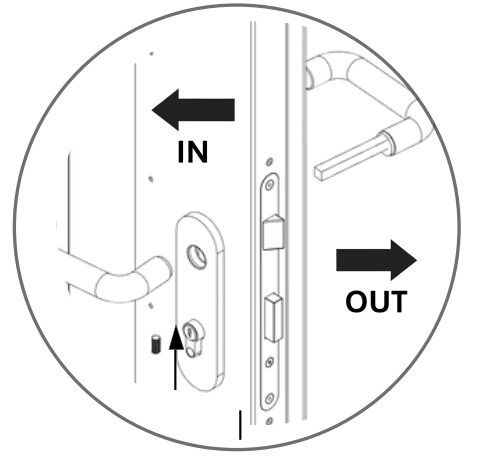

7

