

PRODUCT CODE: 30.110.320

prefabase
Quick Build Solutions

Instructions and User Guide

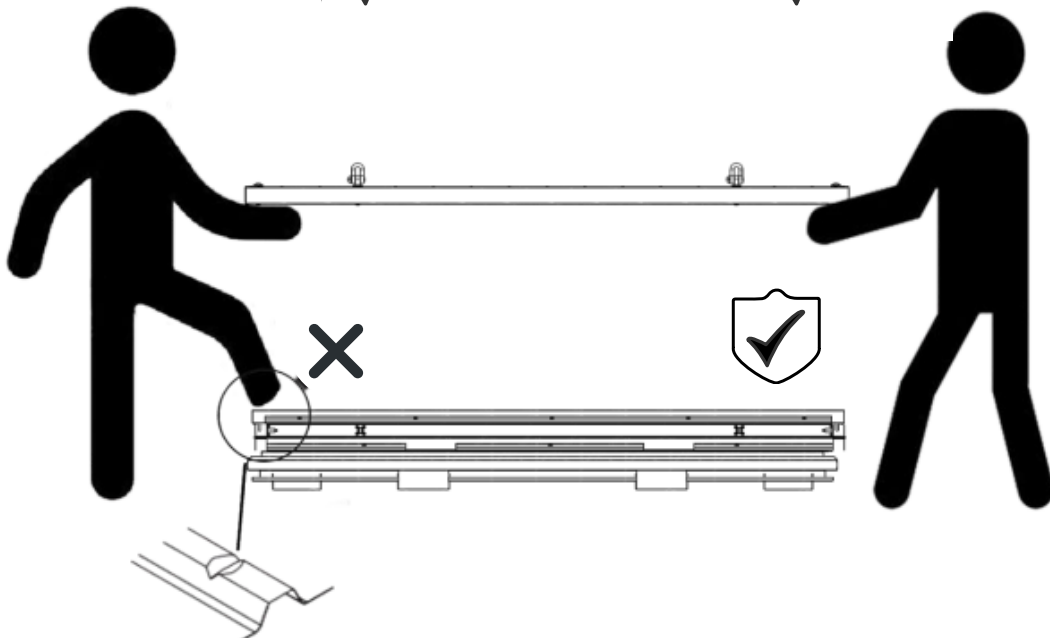
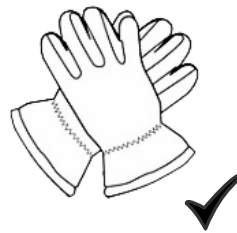

30.0110
1x

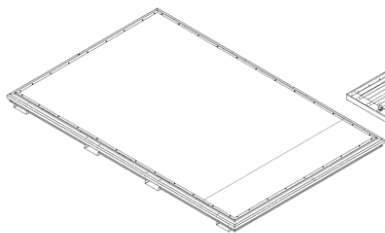

30.0510
1x

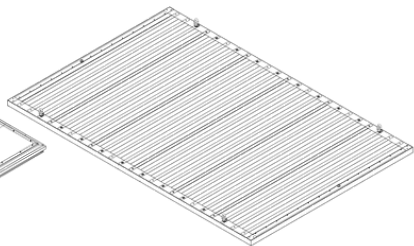

30.0410
2x

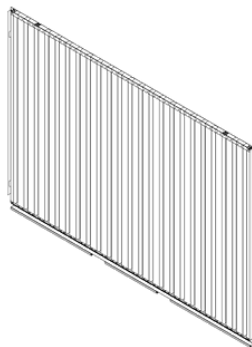

0310
1x



0320
1x

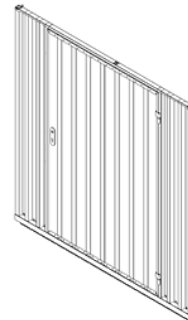

61.101
4x

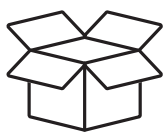

10x

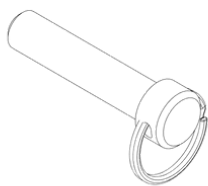

1x

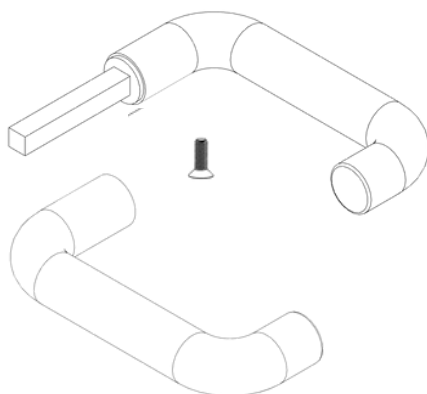

1x

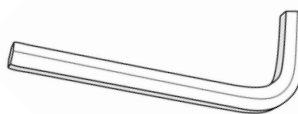

1x



1

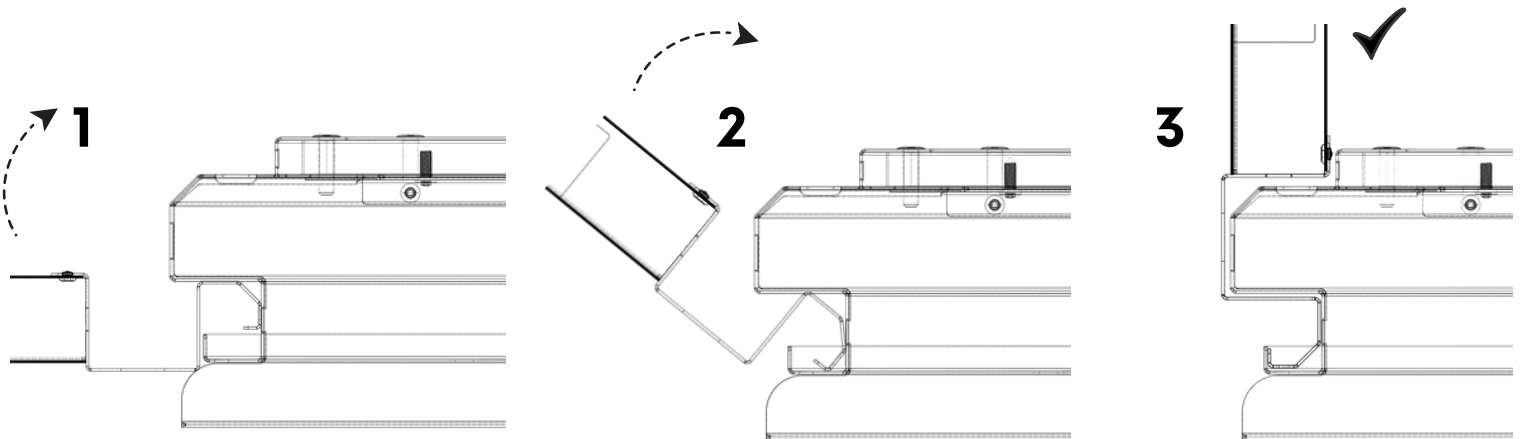
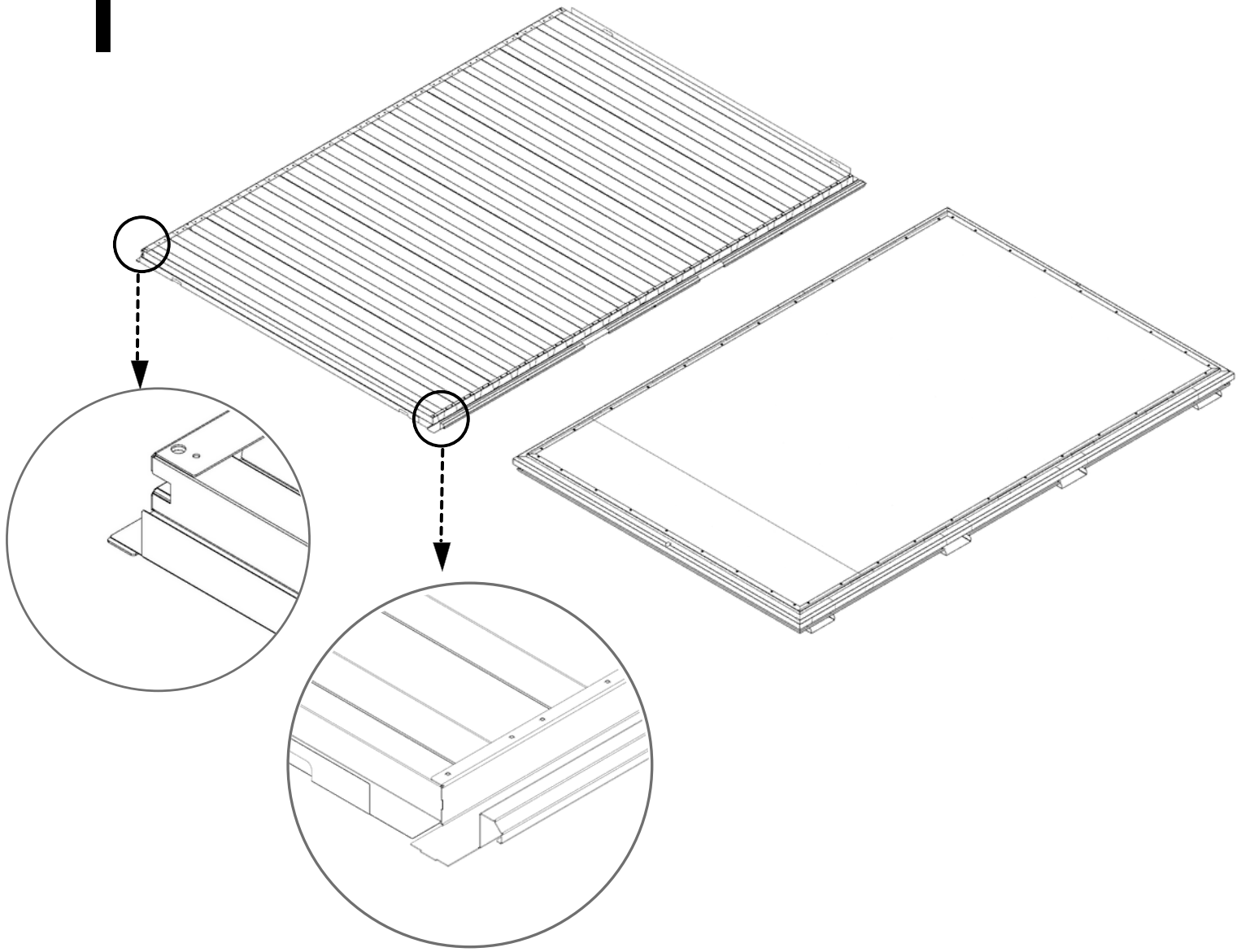

2

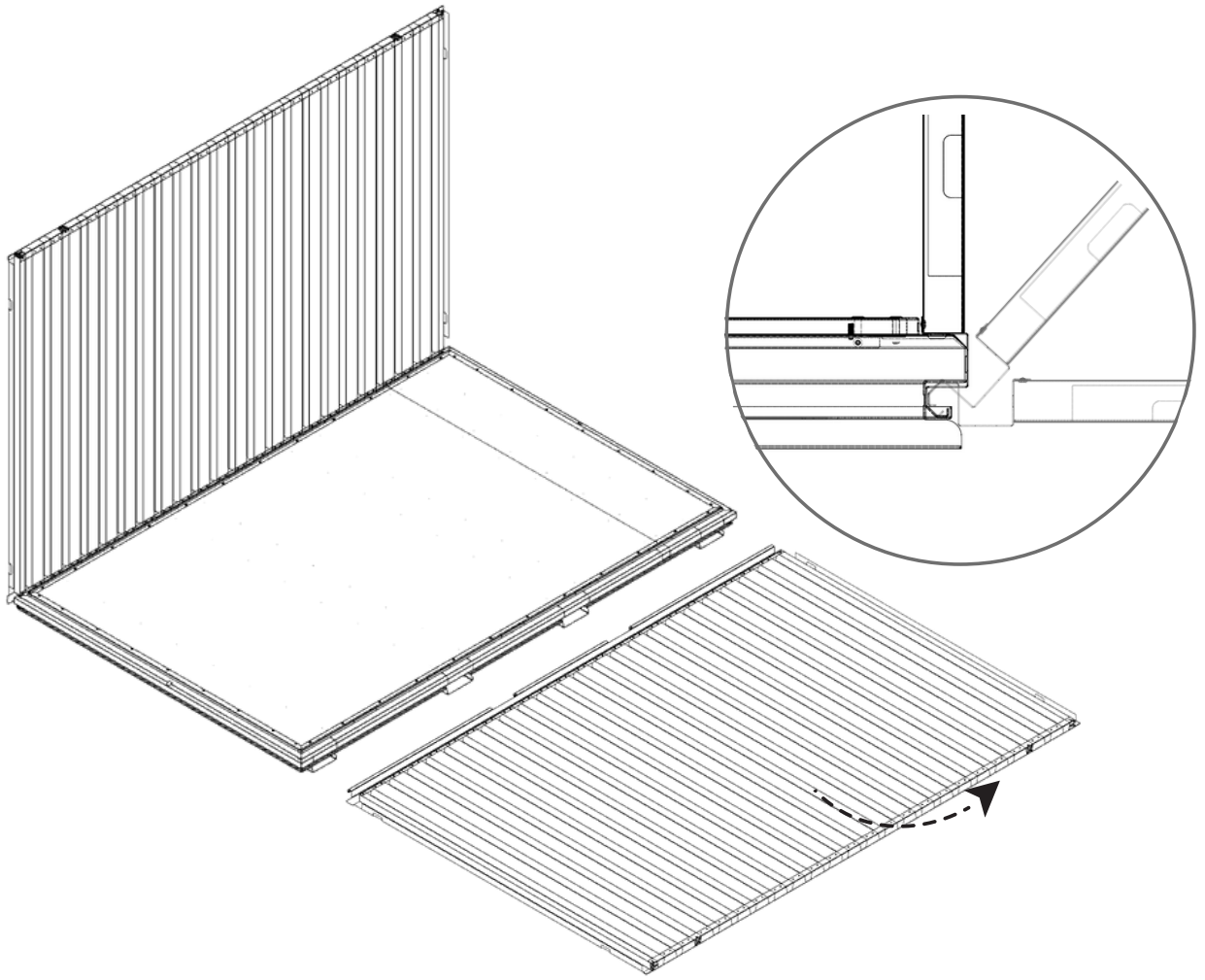

3

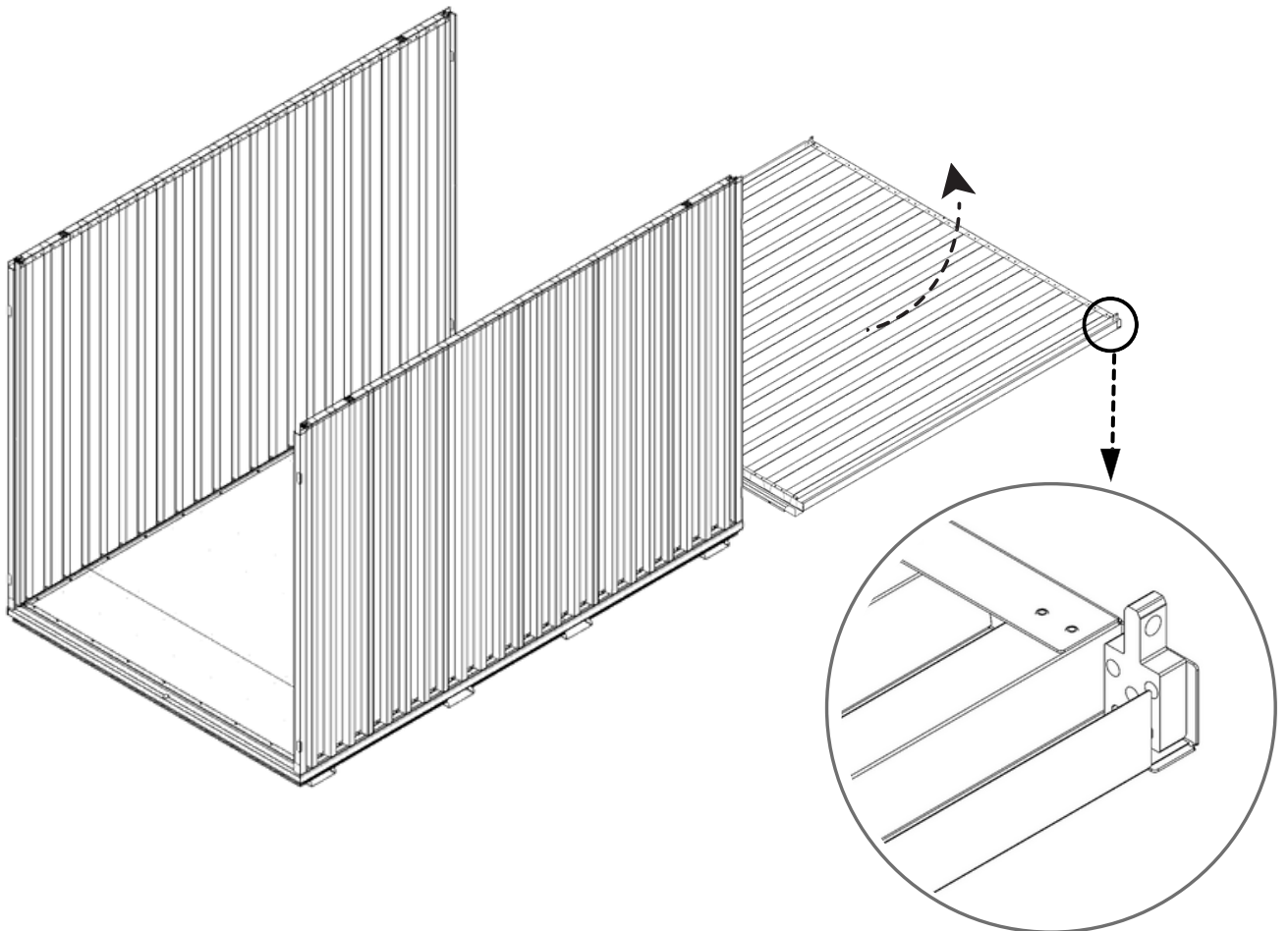

3.1

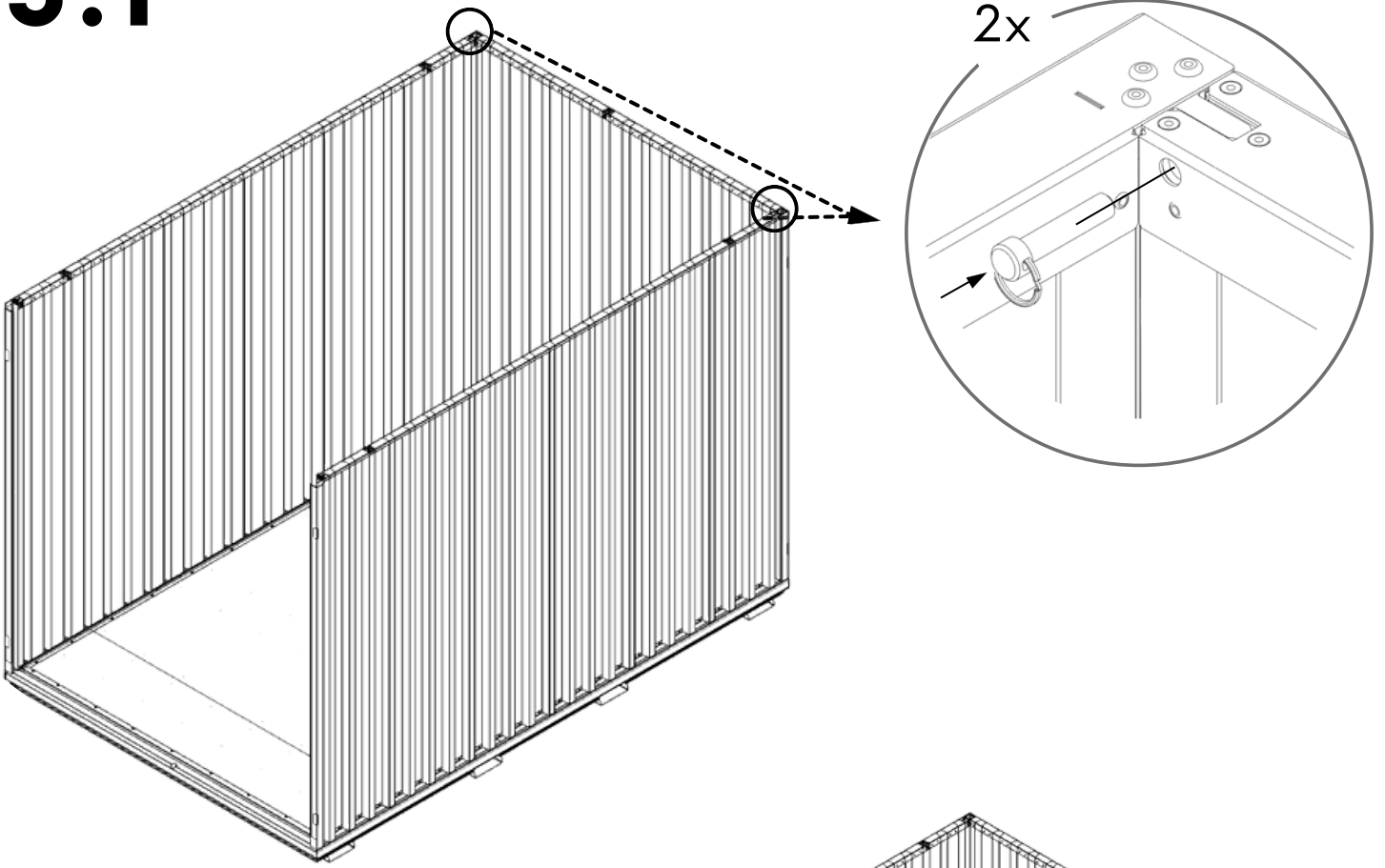



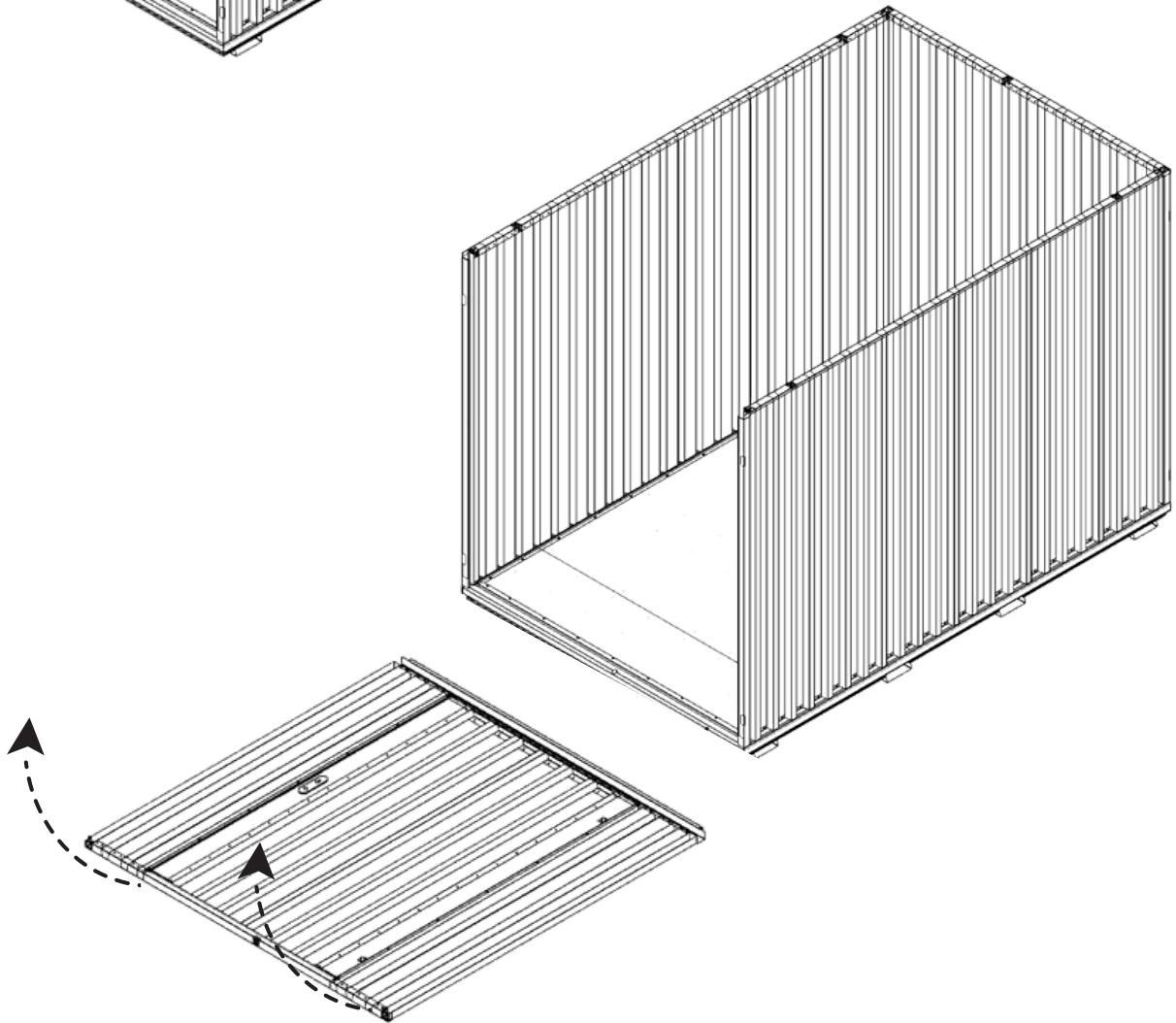



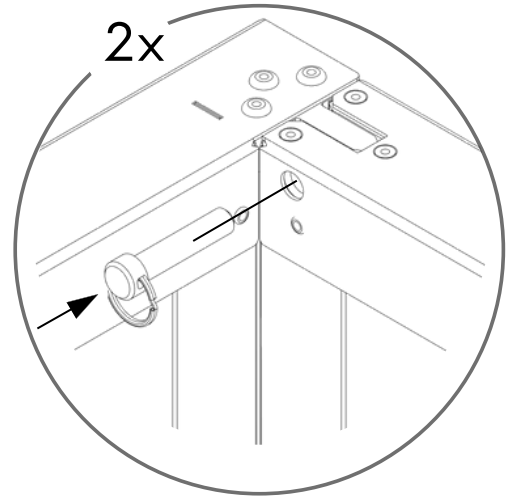
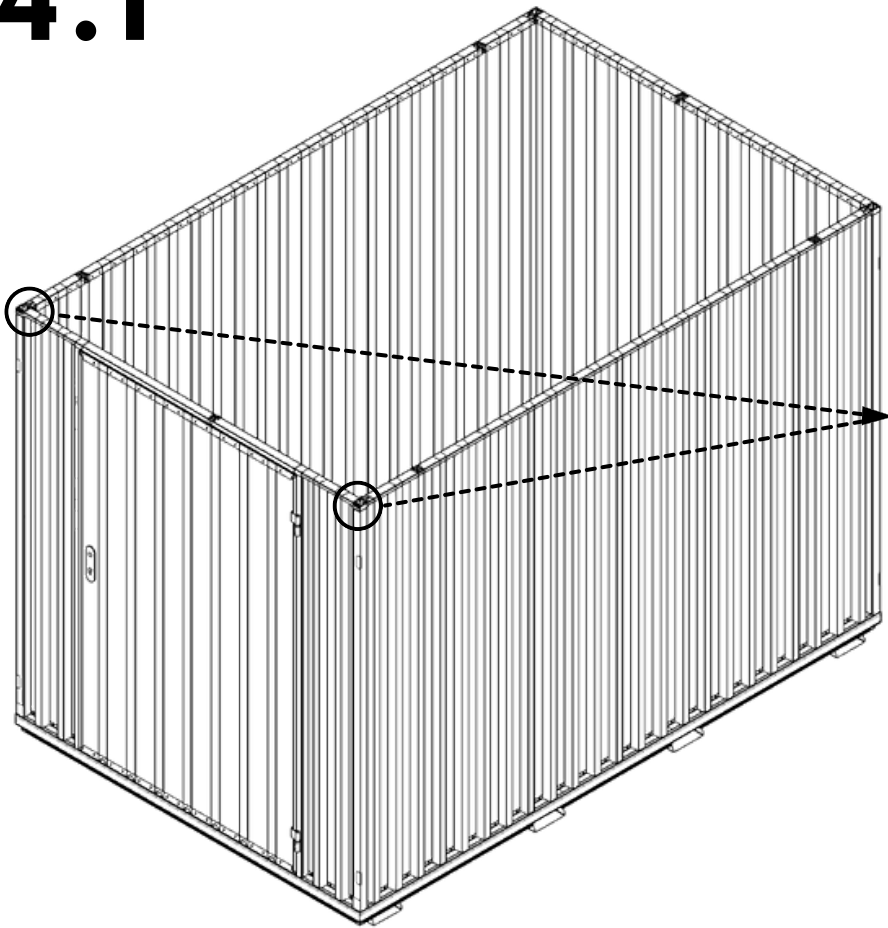

4



4.1



 337 KG	 1640 MM	Model Code: 30.110.320 Production Tracking Code:/X09.1.30.320  9001  14001  50001	 	
---	--	---	---	---

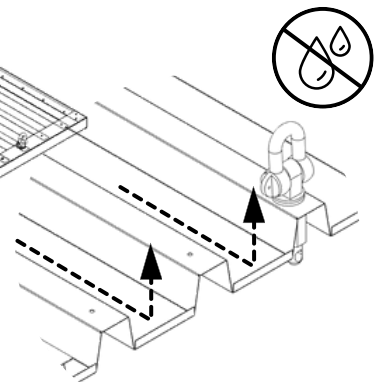
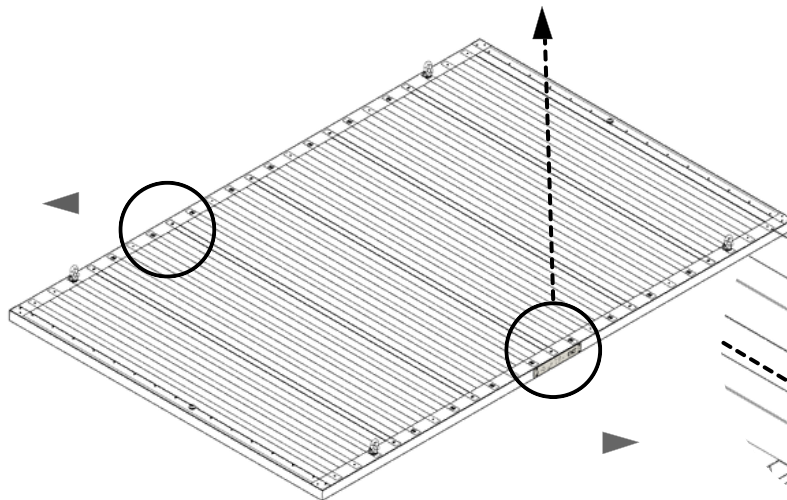
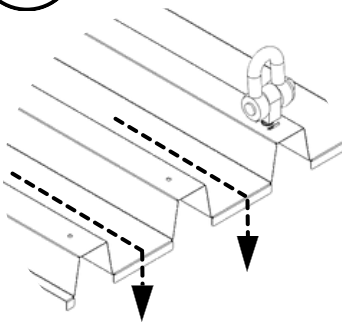

5

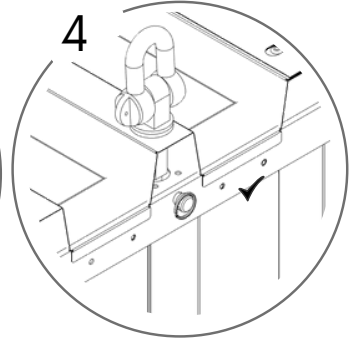
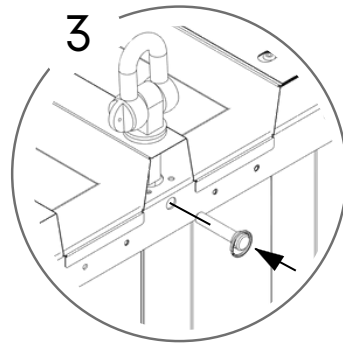
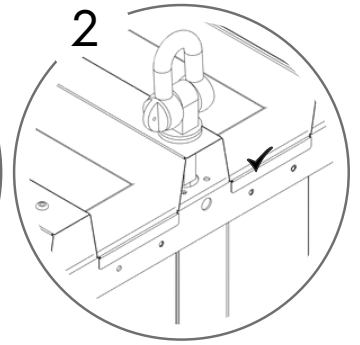
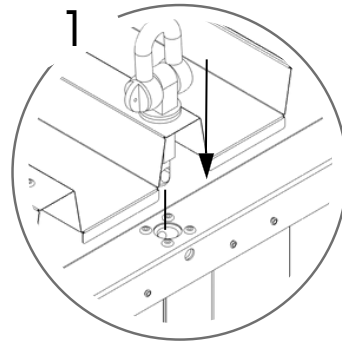
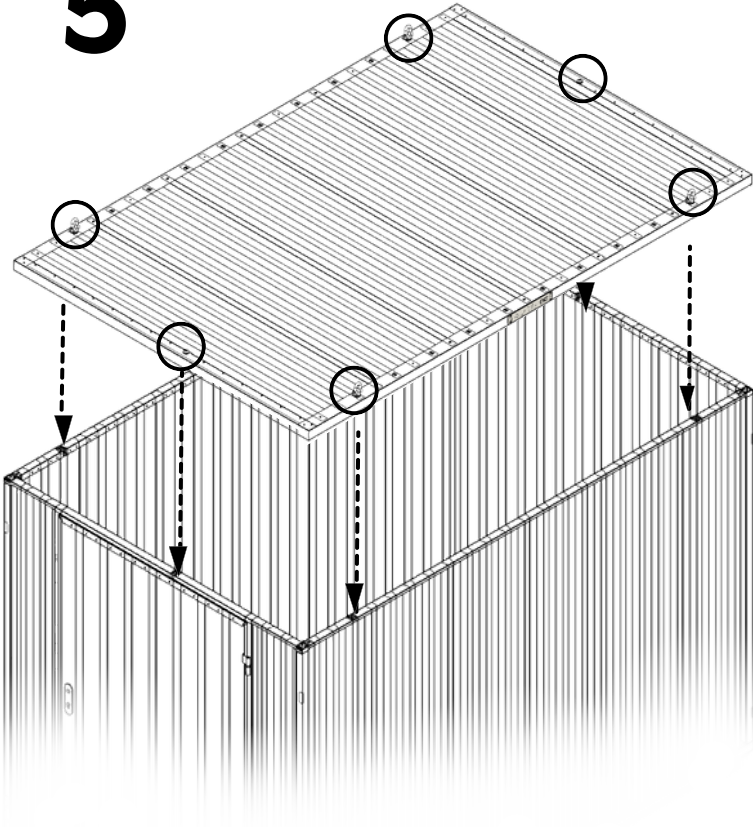

6

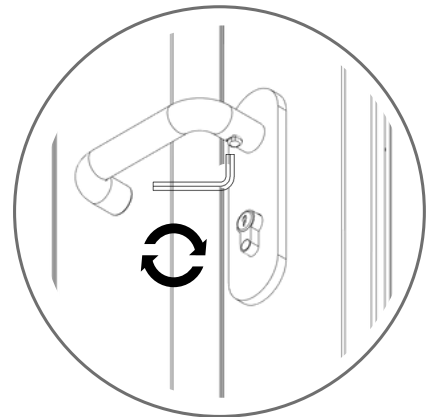
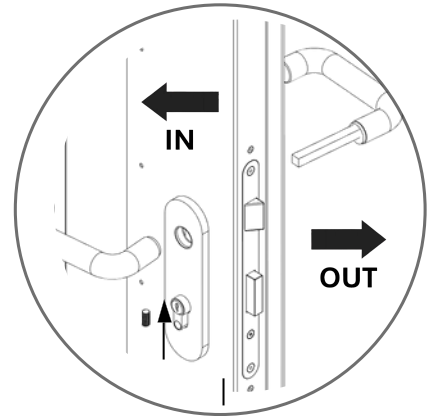
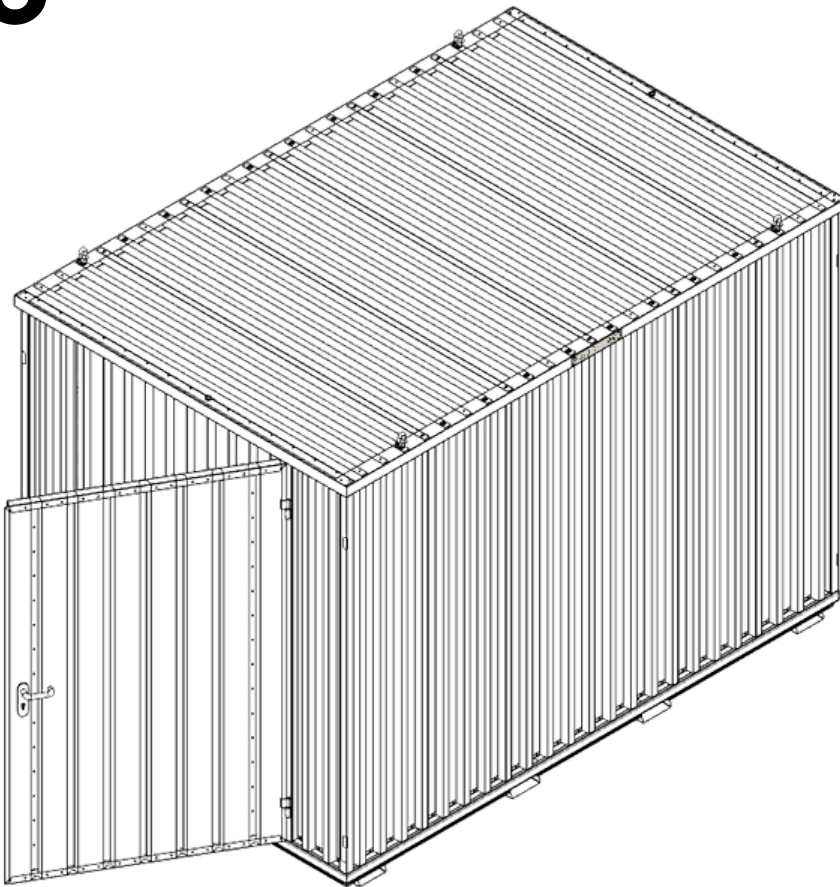

7

