

PRODUCT CODE:40.110.450

prefabase
Quick Build Solutions

Instructions and User Guide



40.0110
1x

40.0410
1x

40.0450/0210
1x

0310
2x

40.0510
1x

0099.61.101
4x

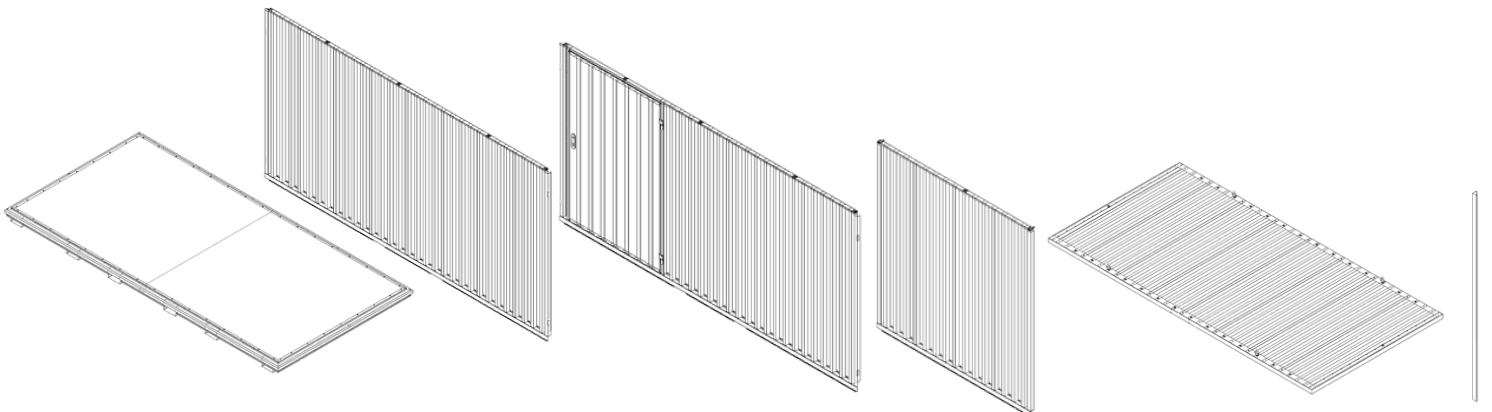



12x



1x



1x



1x

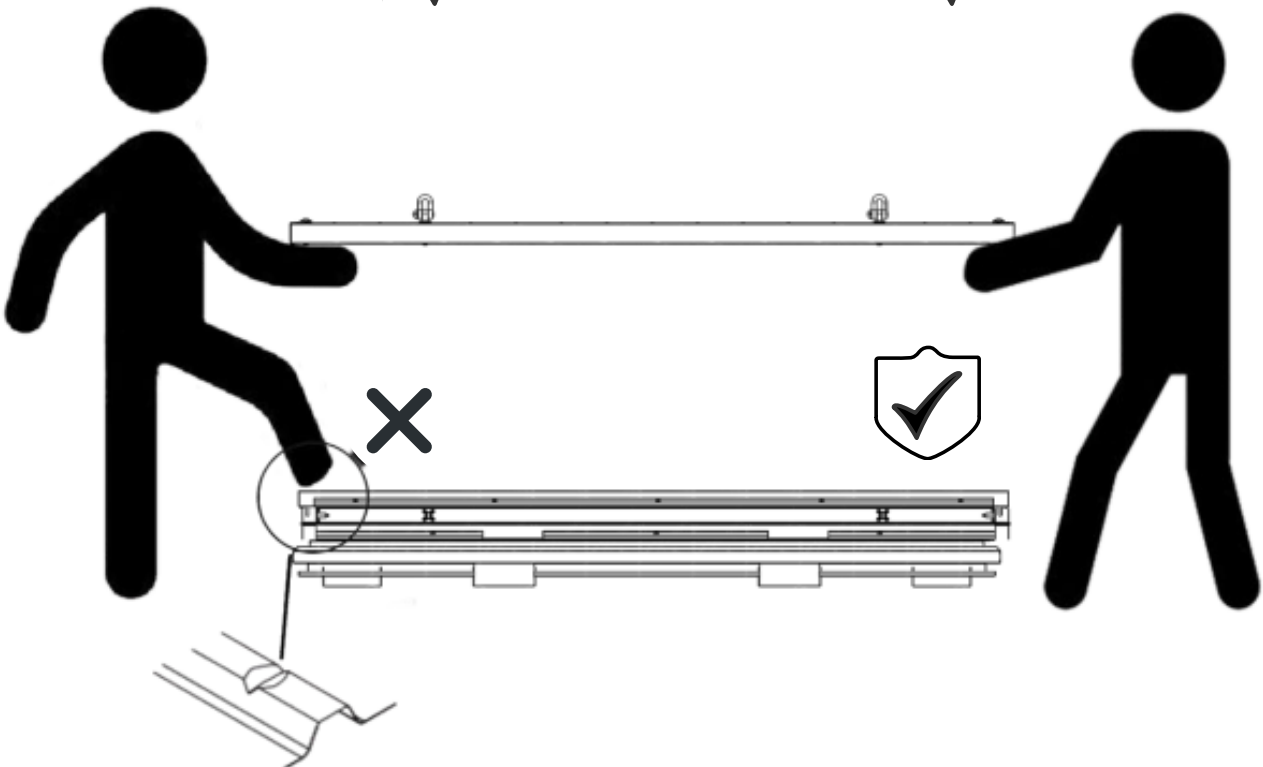

1

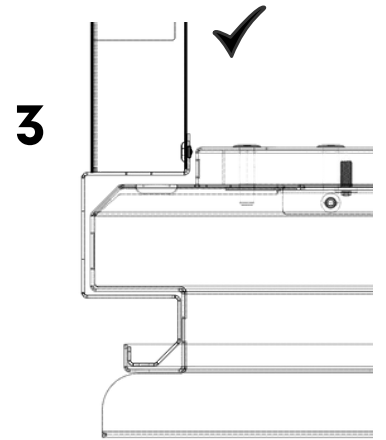
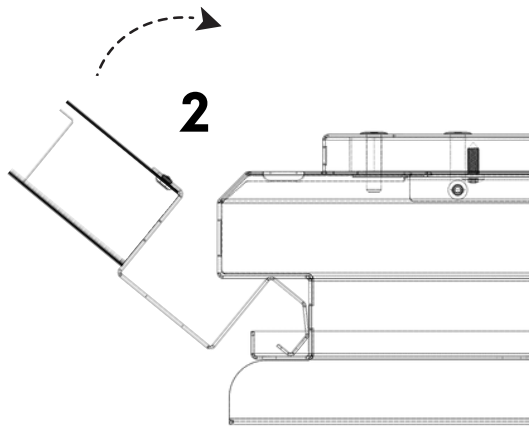
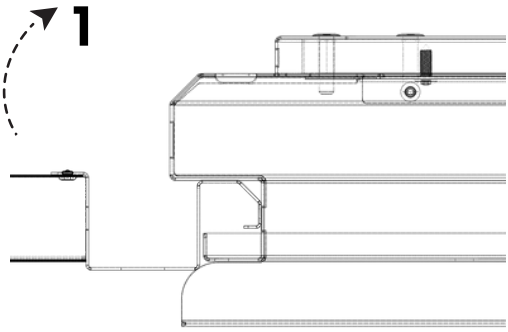
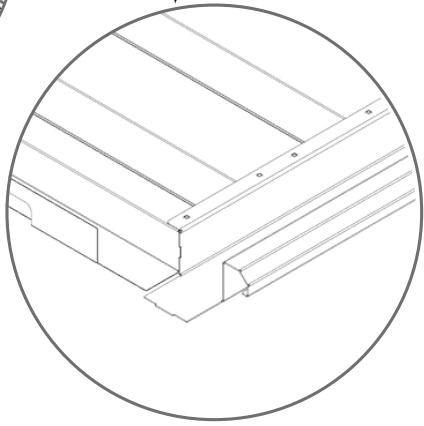
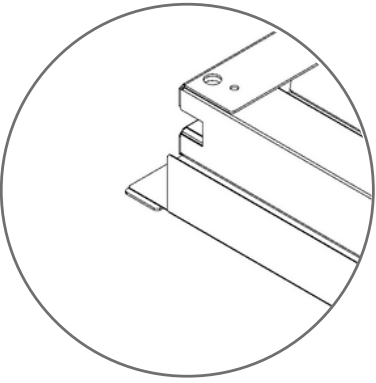
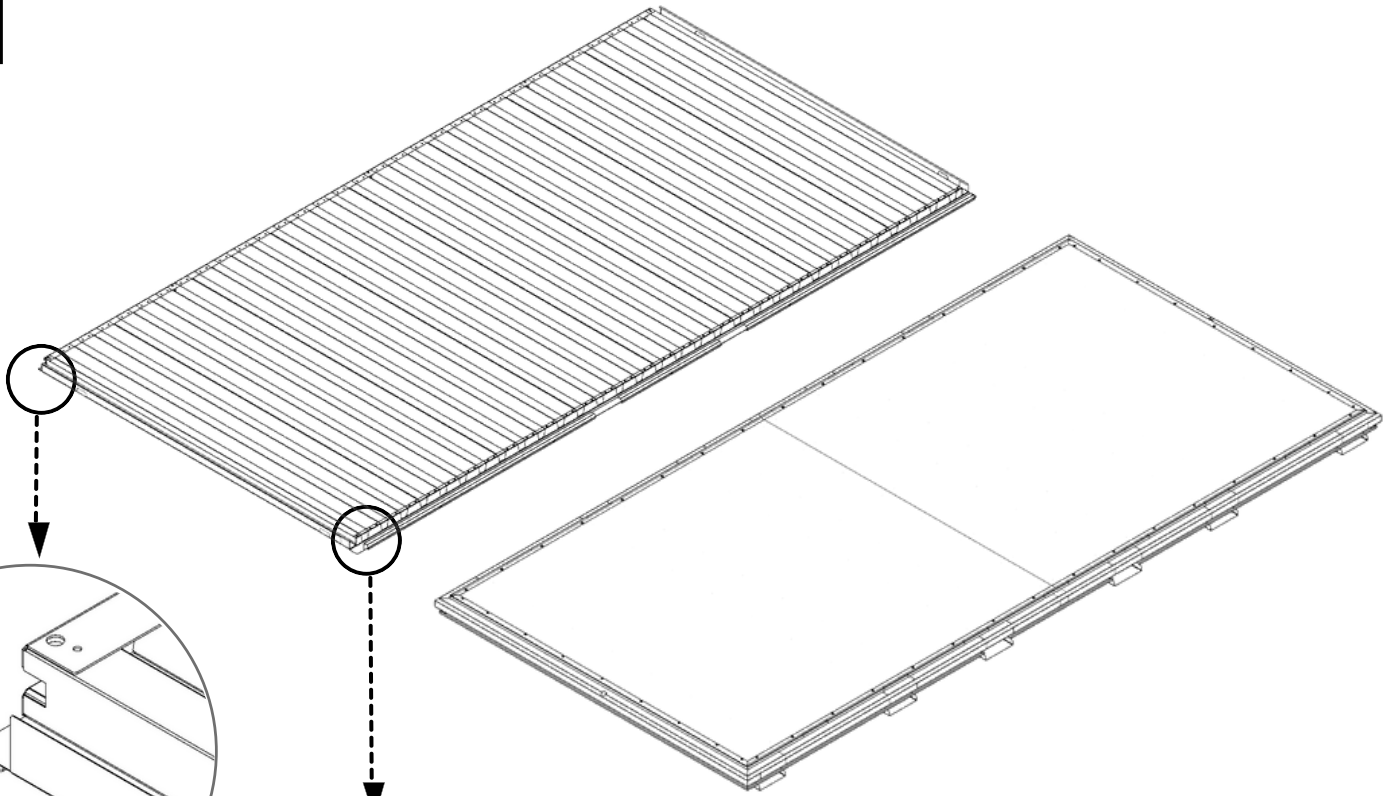

2

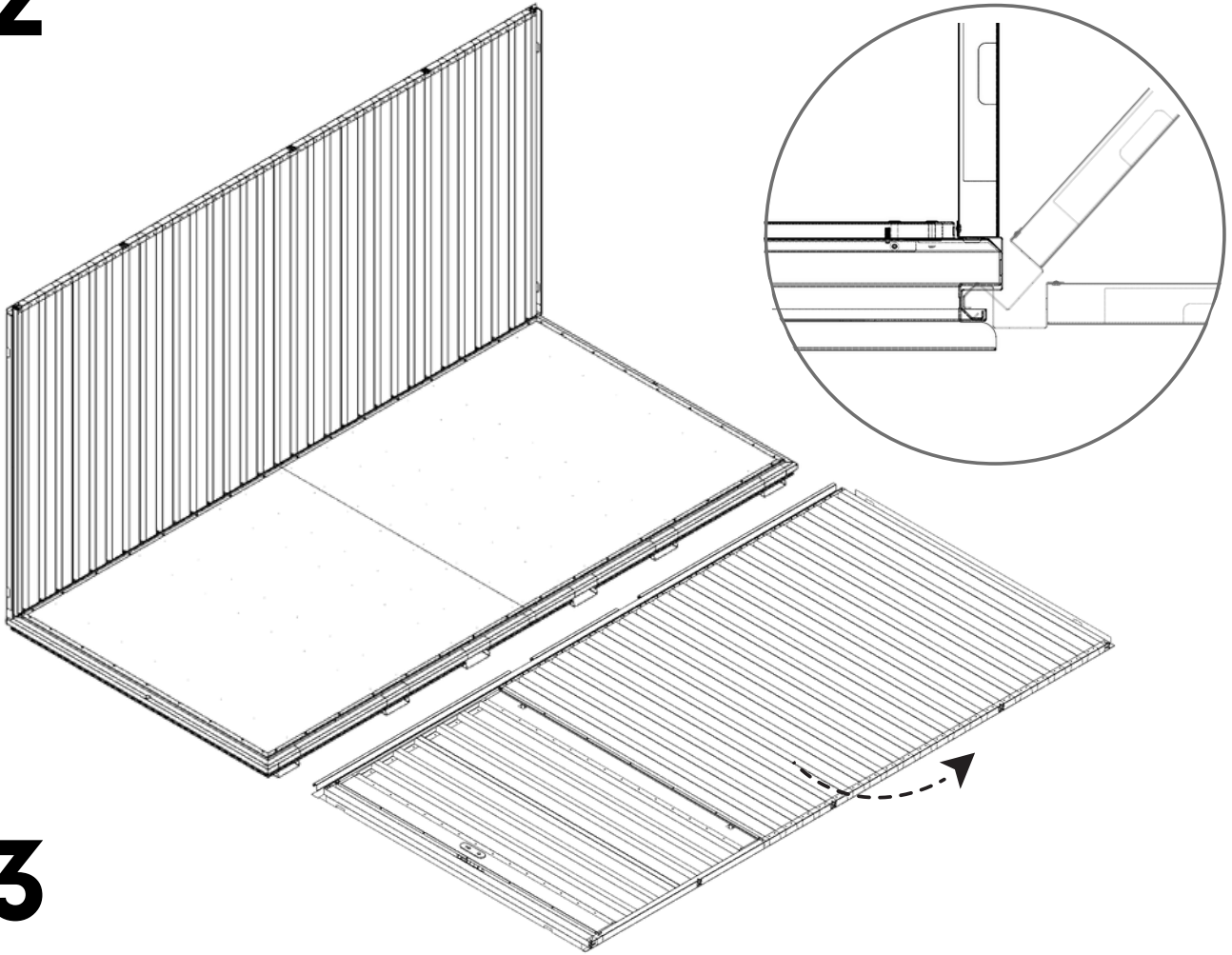

3

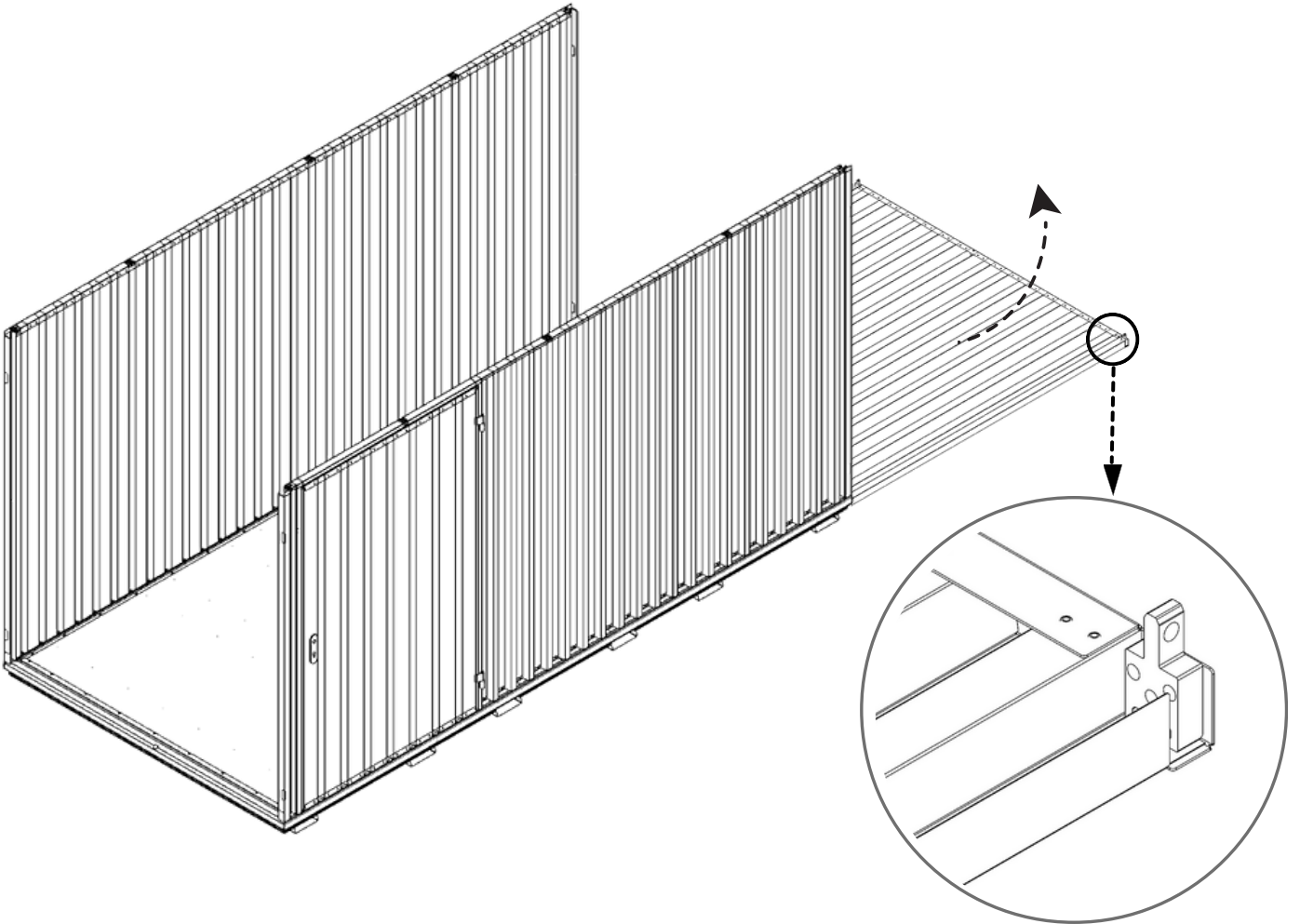

3.1

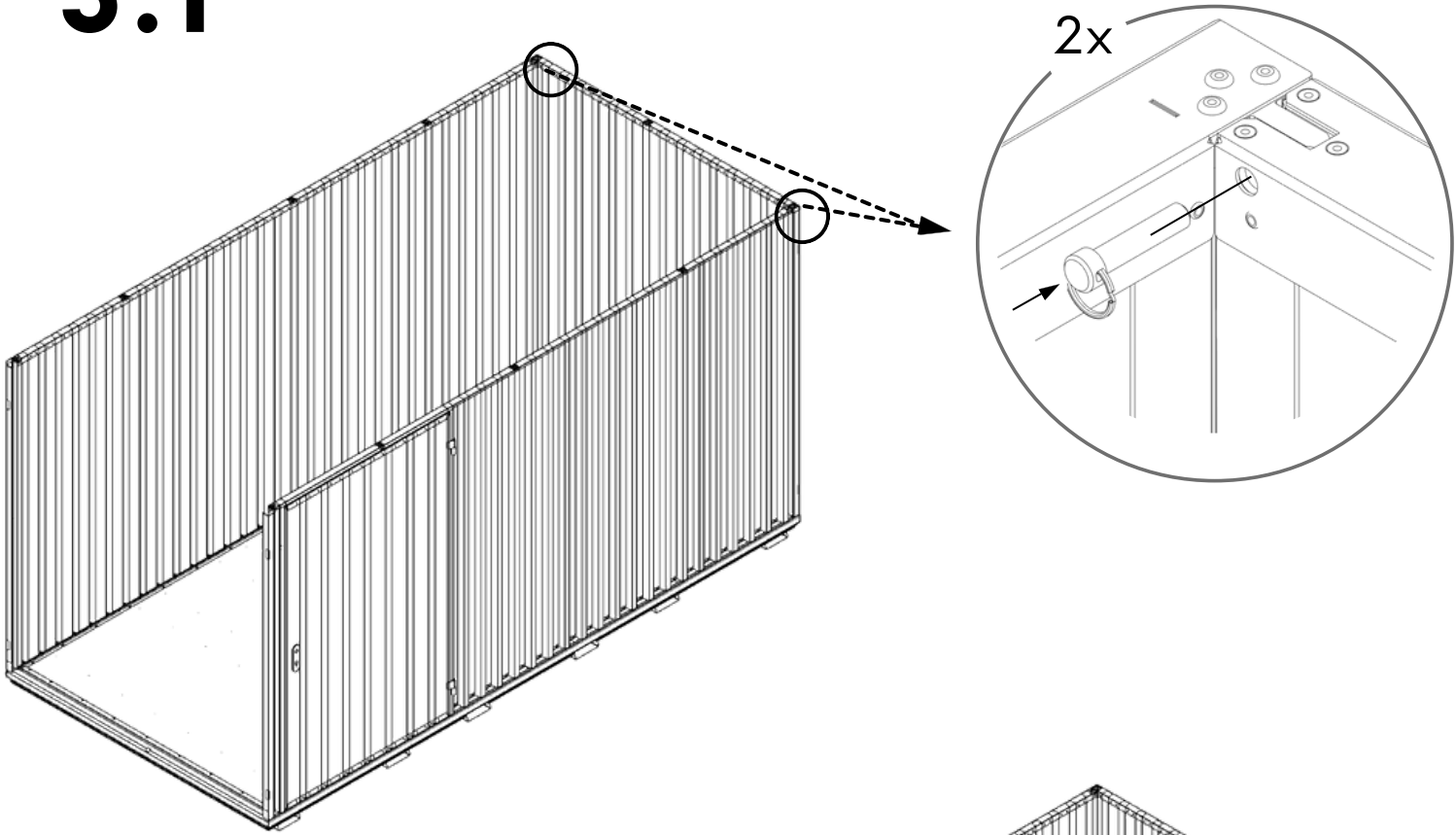



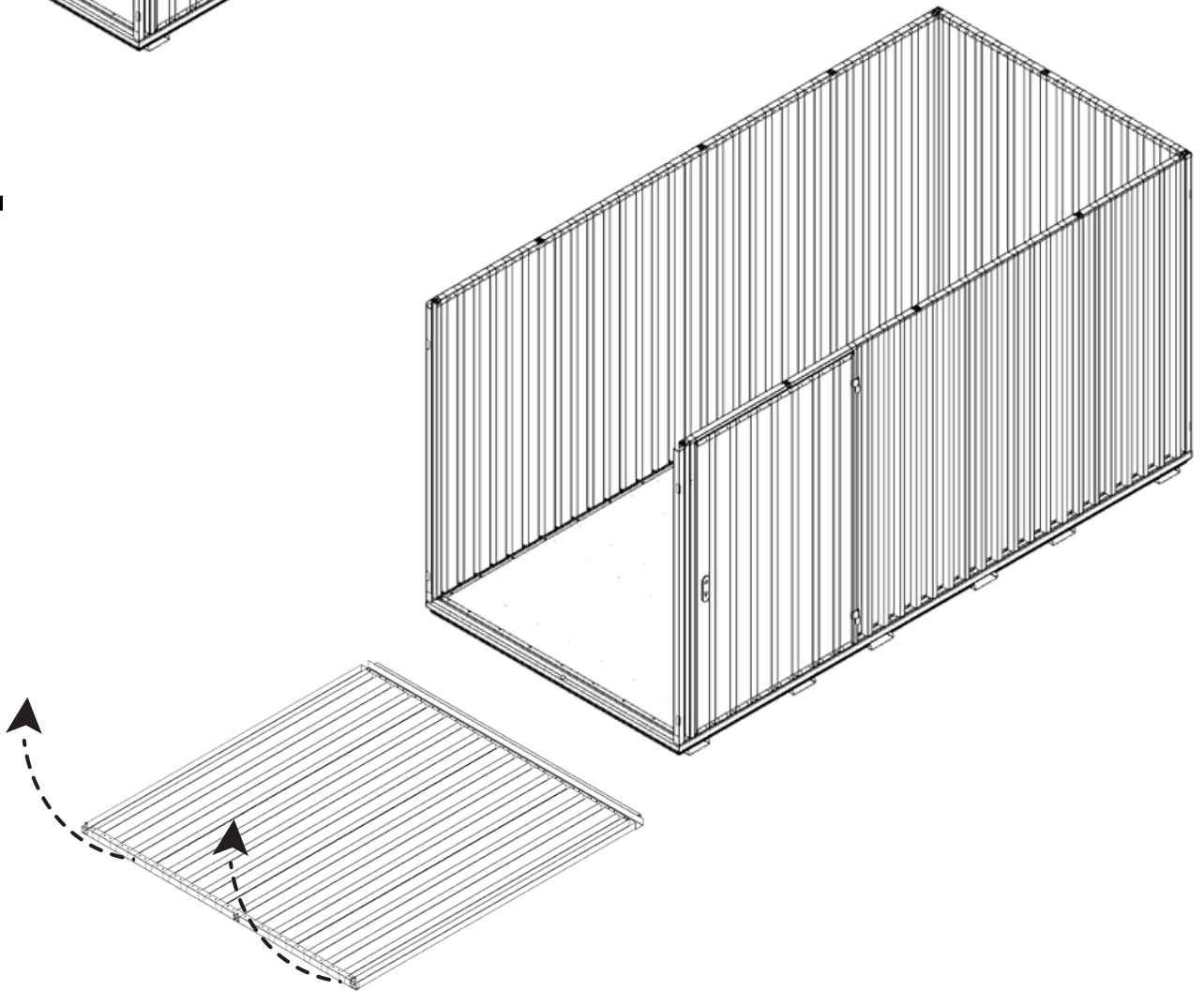



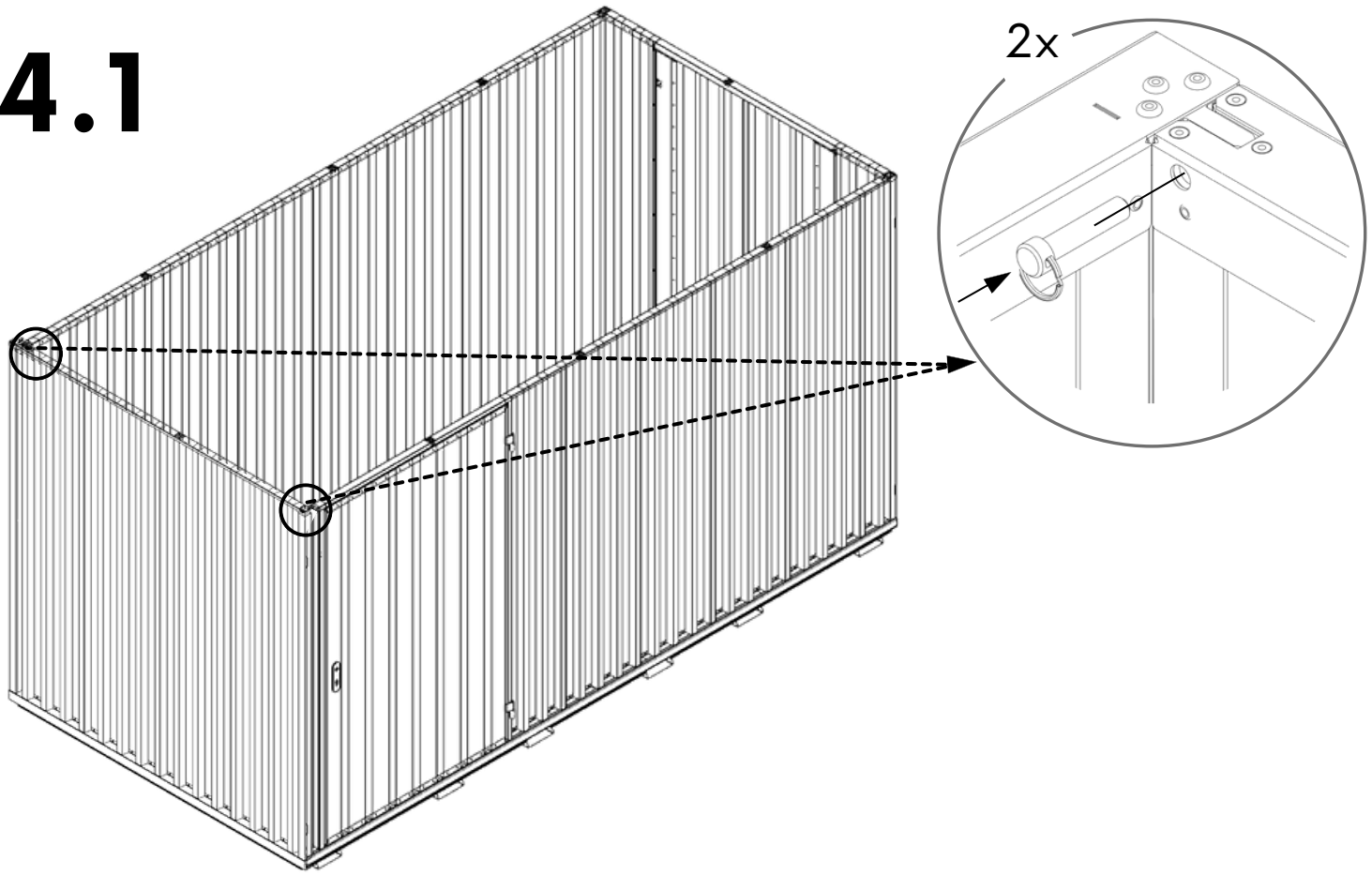

4



4.1



 336 KG	 3 TON	 1640 MM	Model Code: 30.110.440 Production Tracking Code:X09.1.30.440  9001  14001  50001	  
---	--	--	---	---

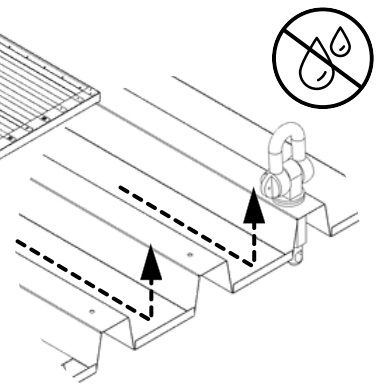
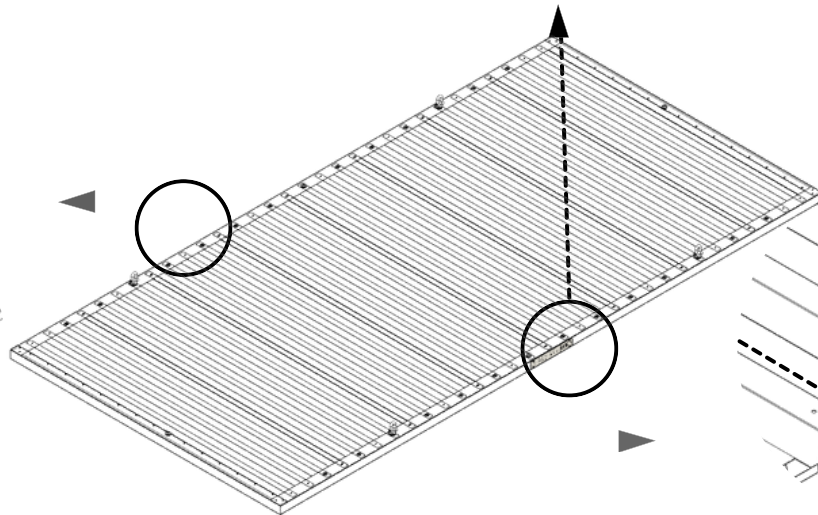
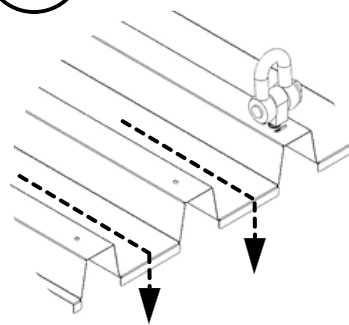

5

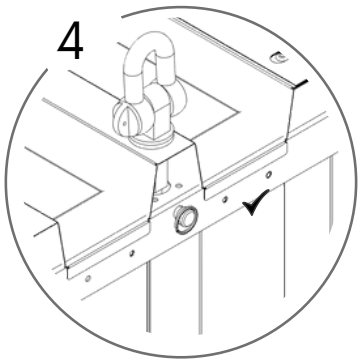
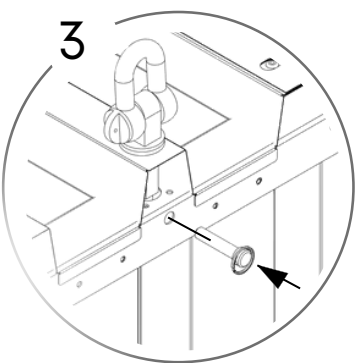
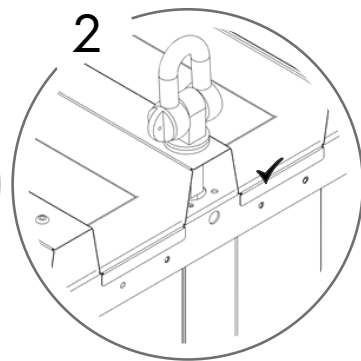
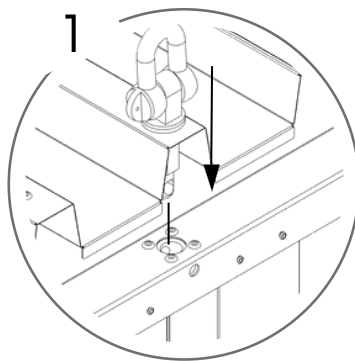
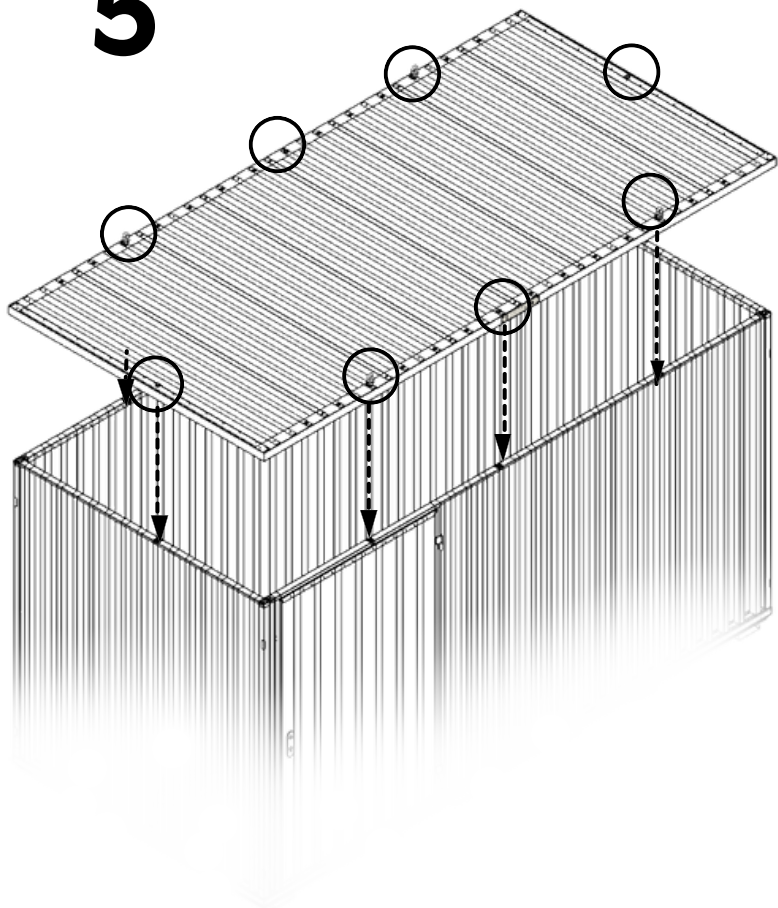

6

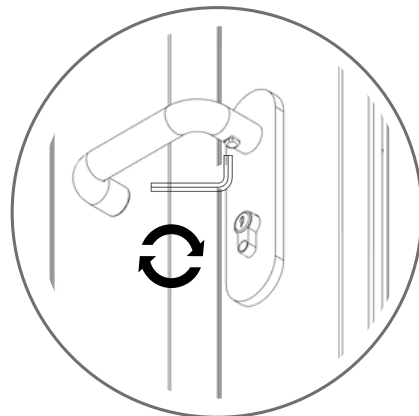
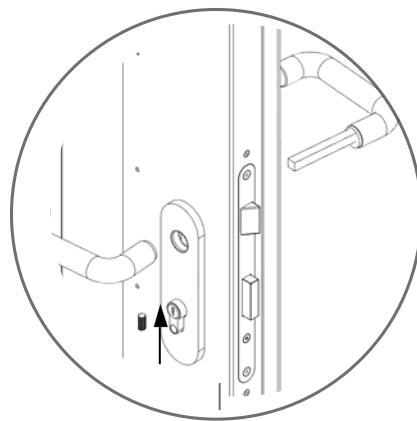
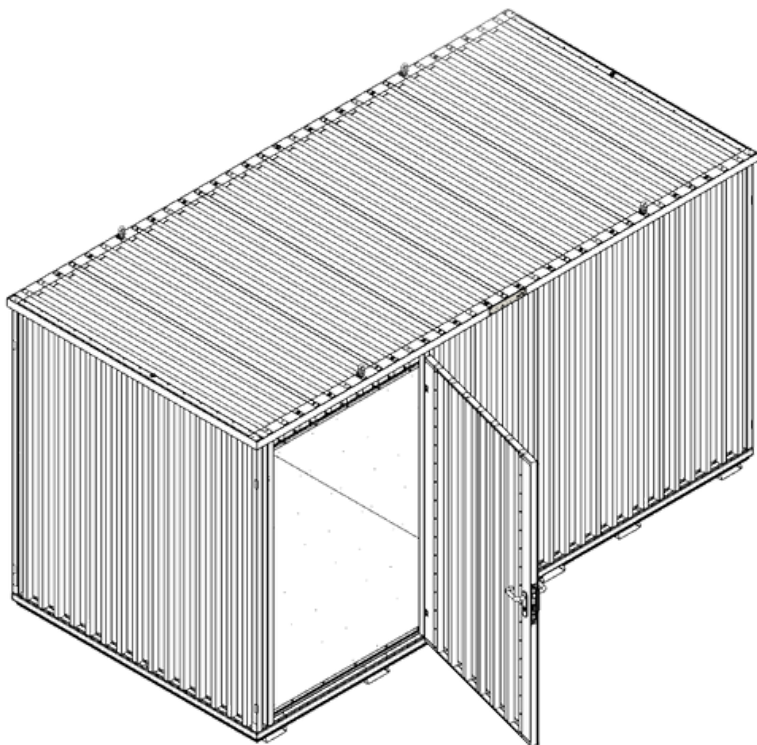

7

