







PRODUCT CODE :3033.110.430.440



	30 pcs.
	2 pcs.
	2 pcs.
	20 pcs.
	20 pcs.
	20 pcs.

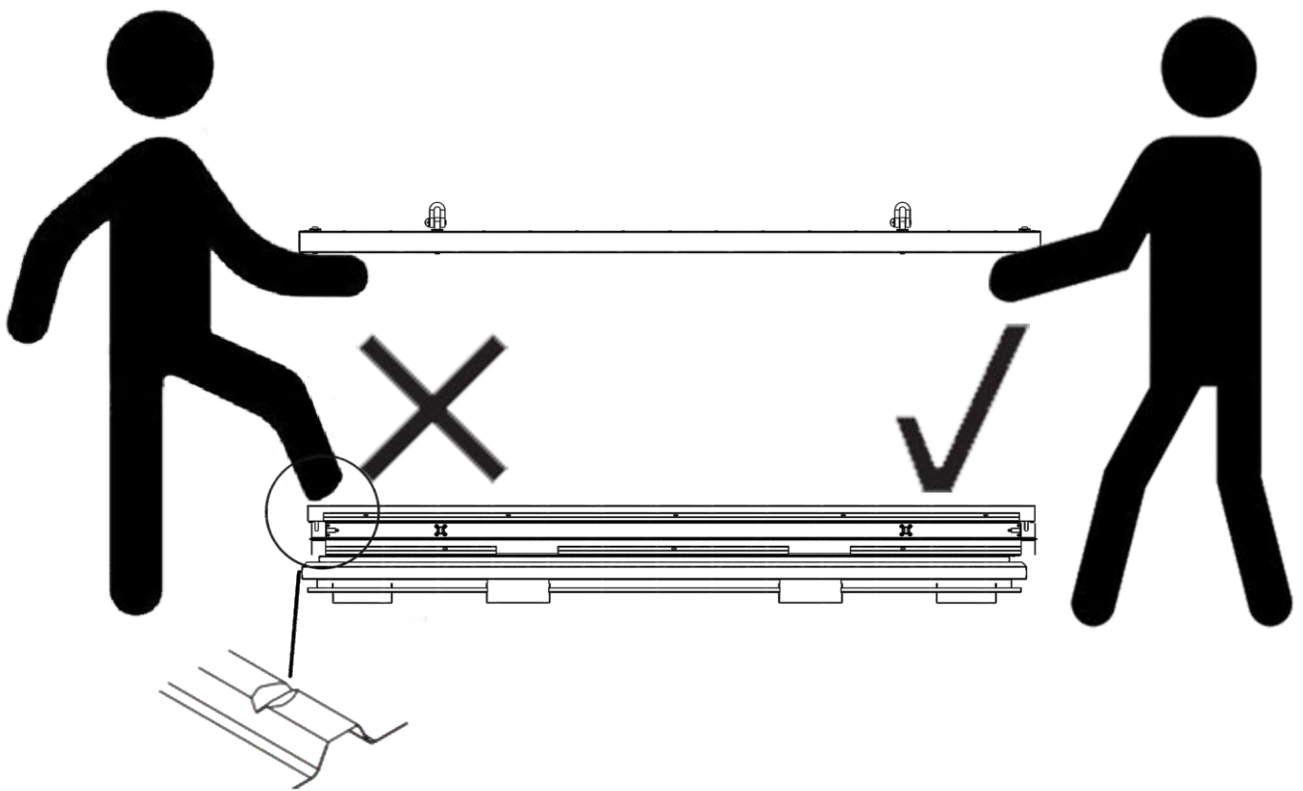
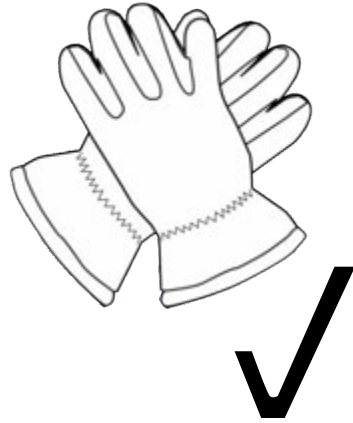

1.1.

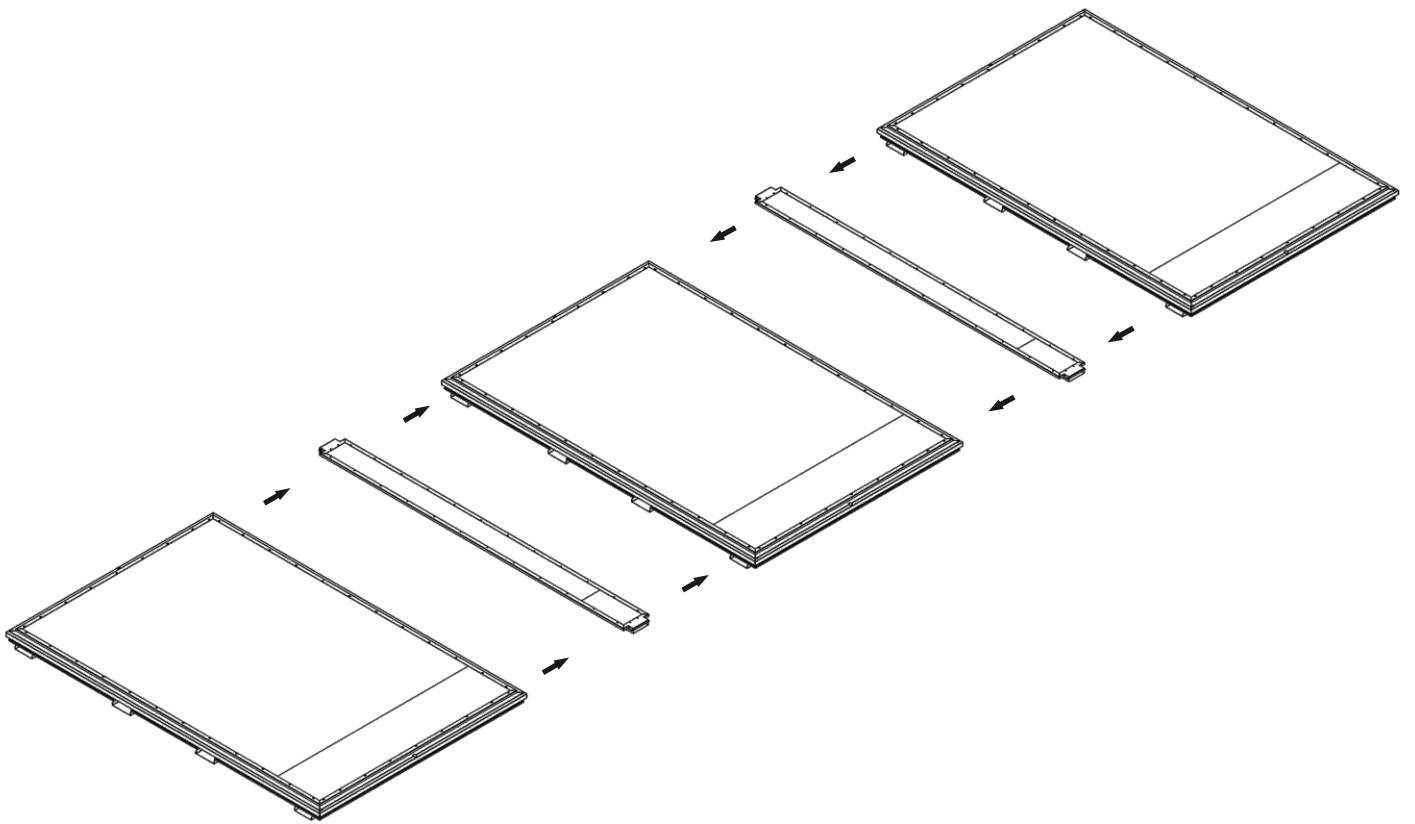

1.2.

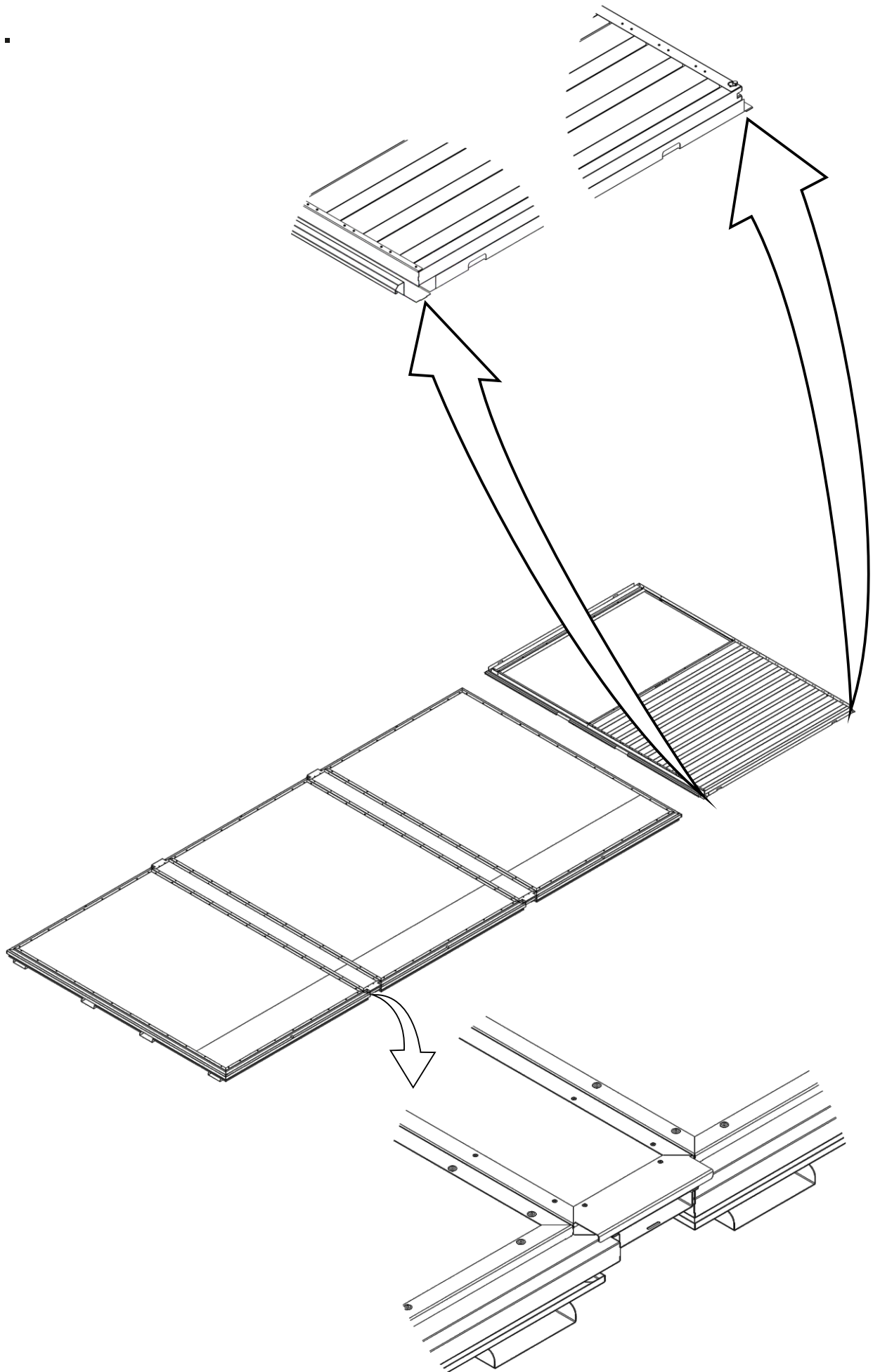

2.1.

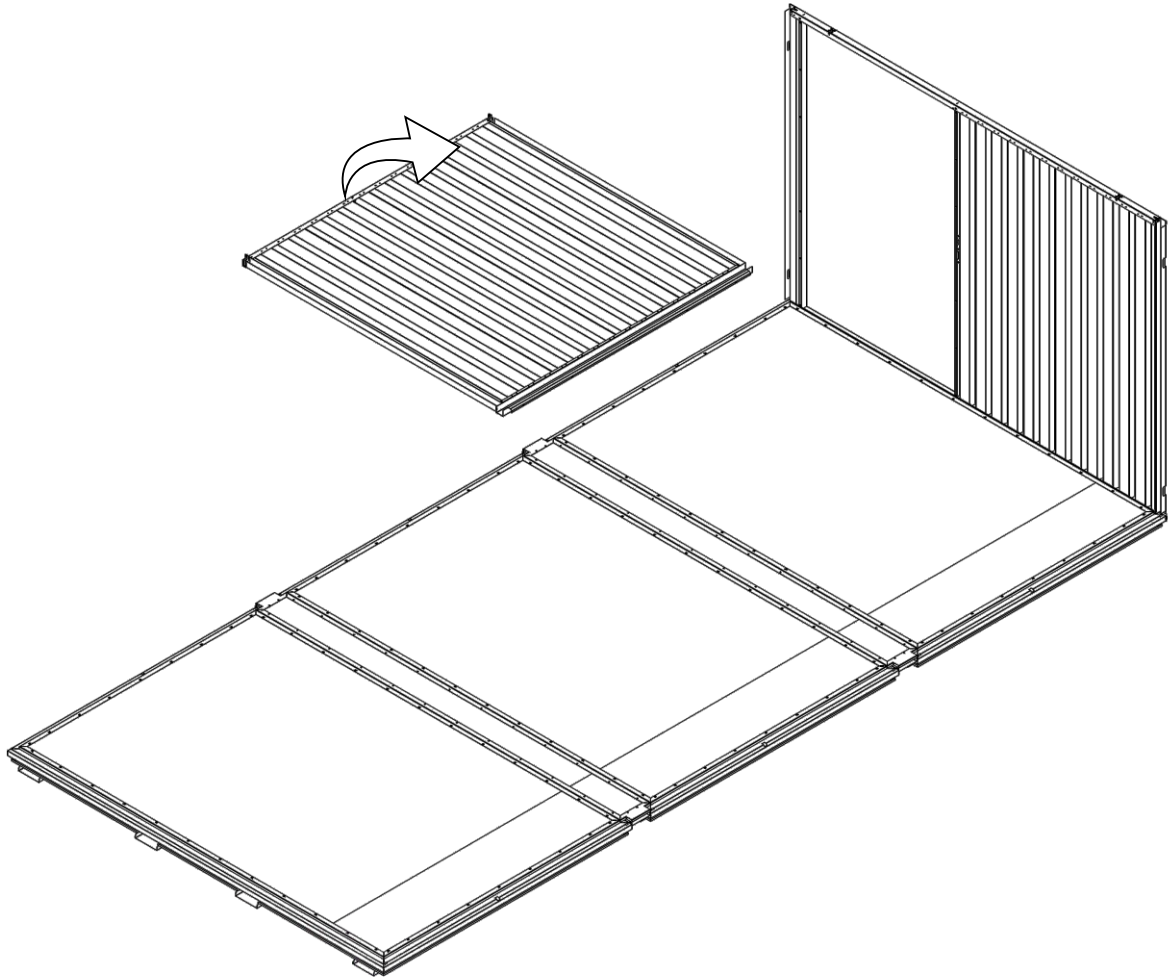

3.1.

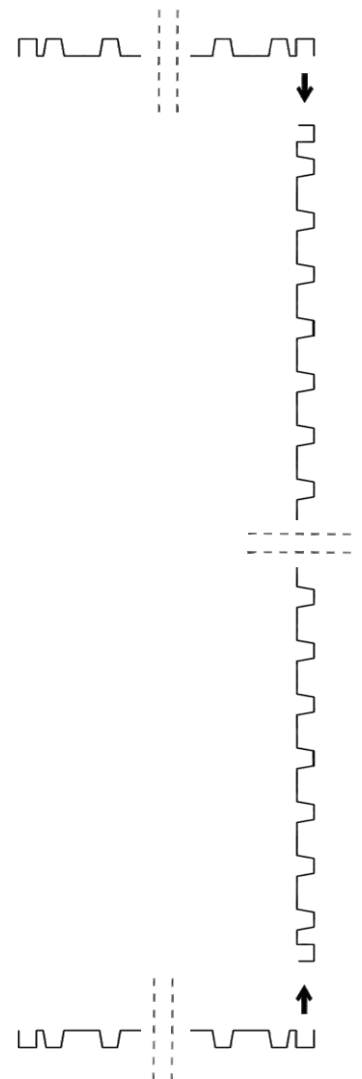
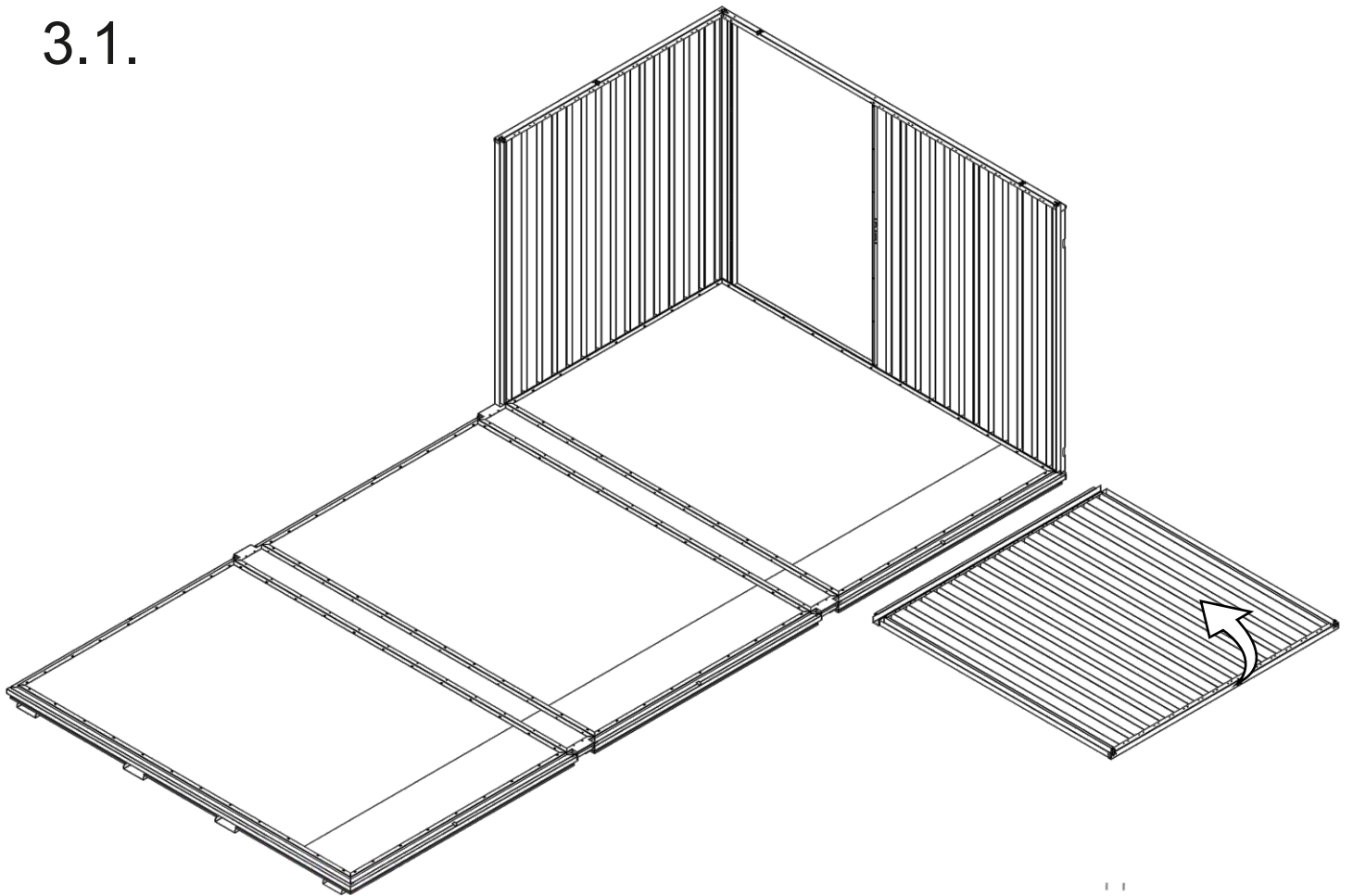

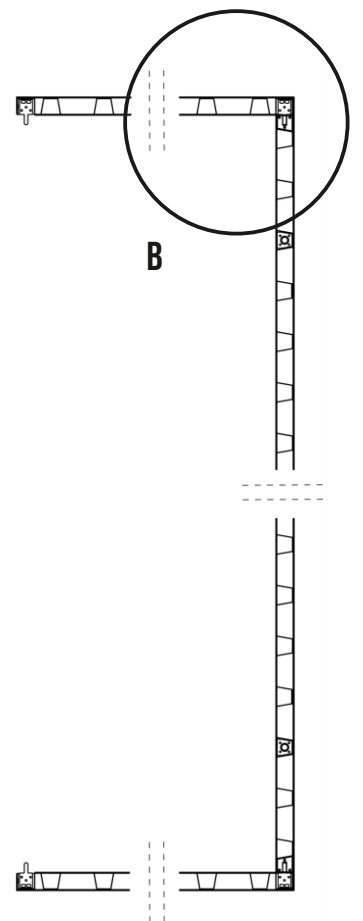
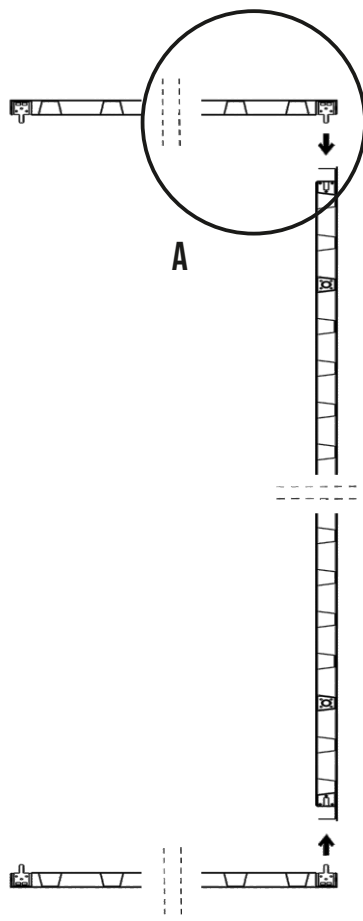
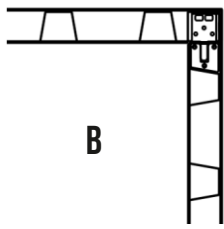
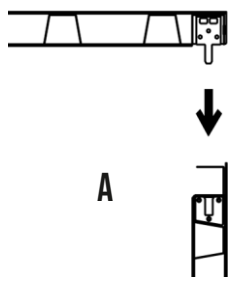

3.2.

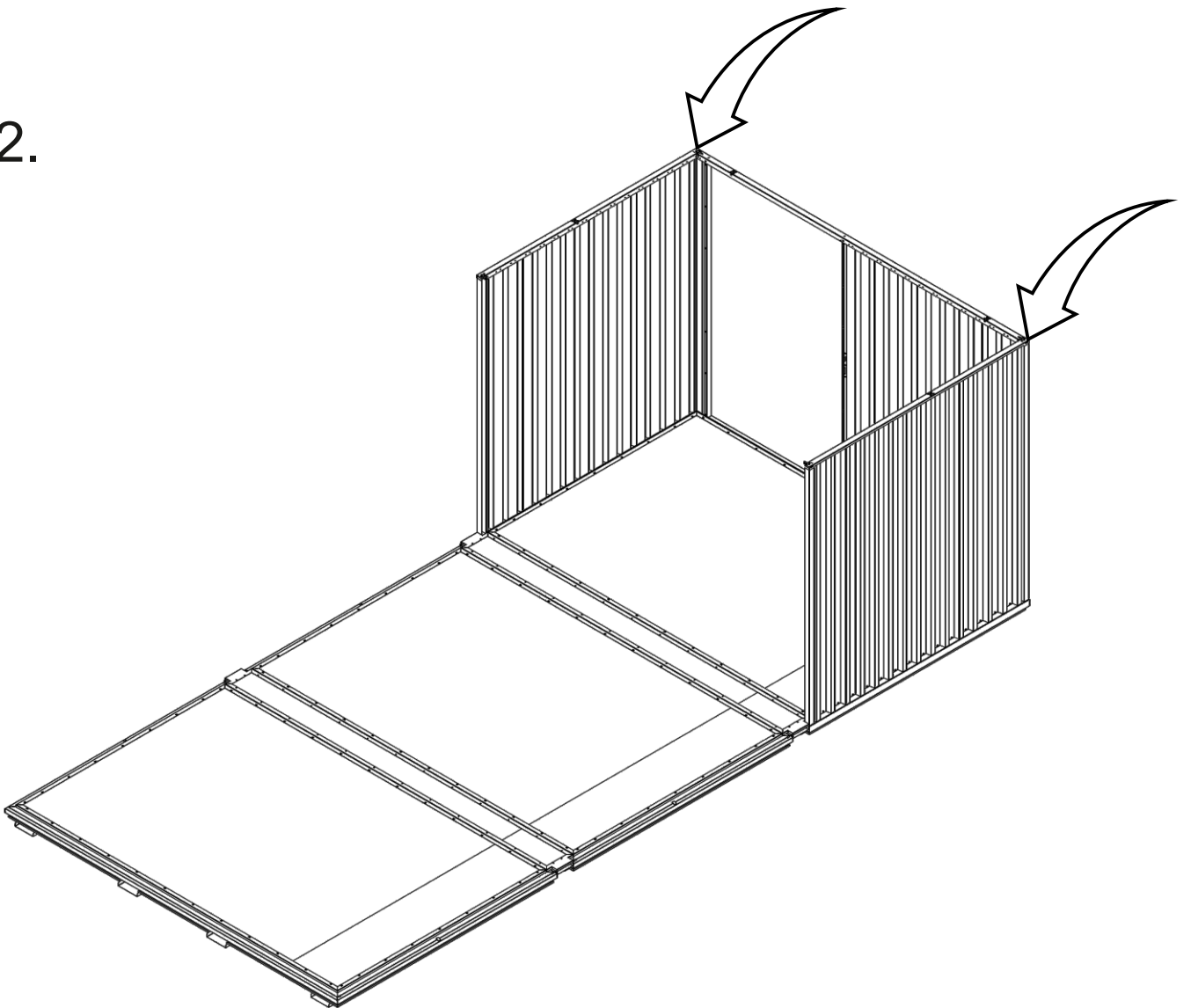

3.3.

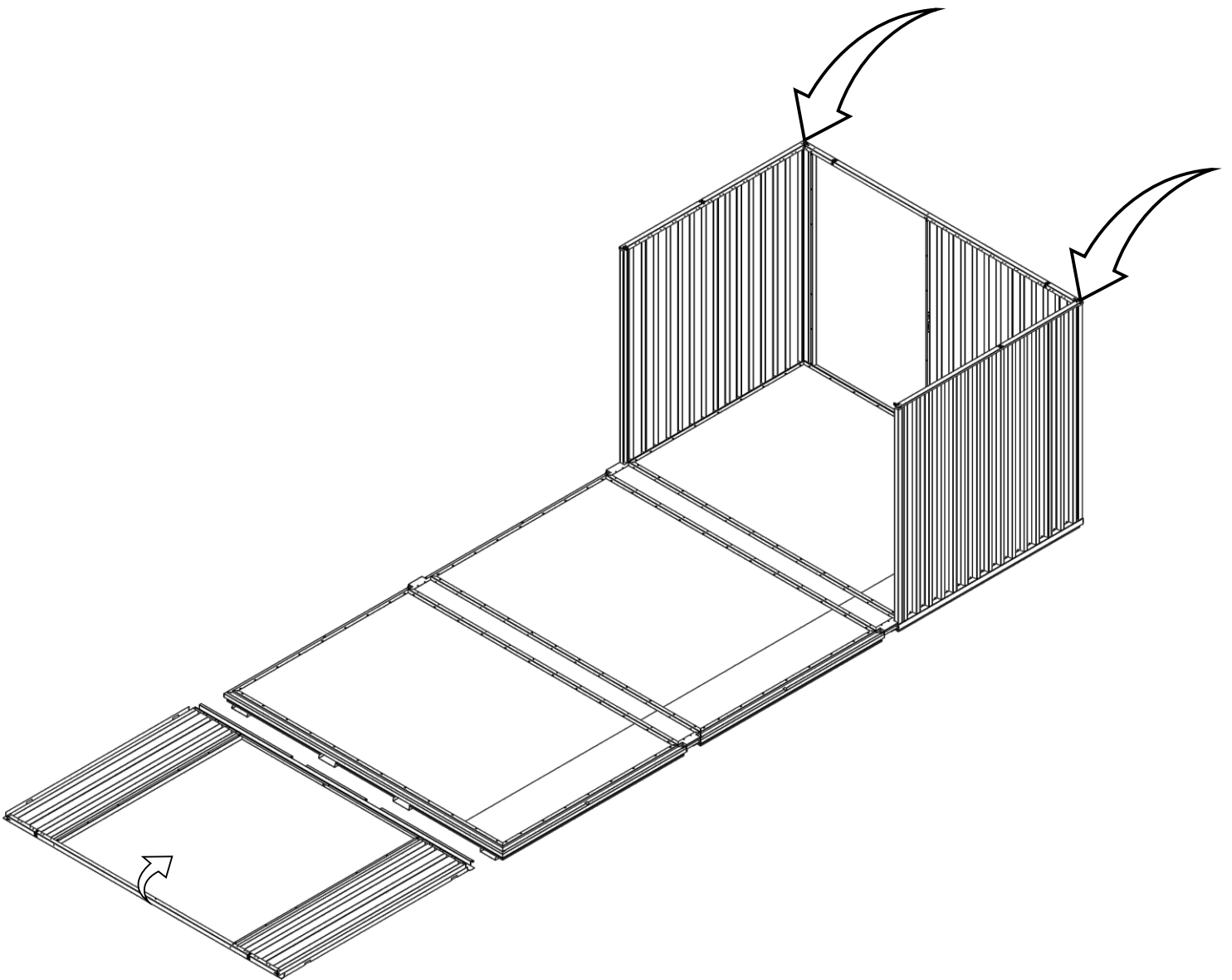
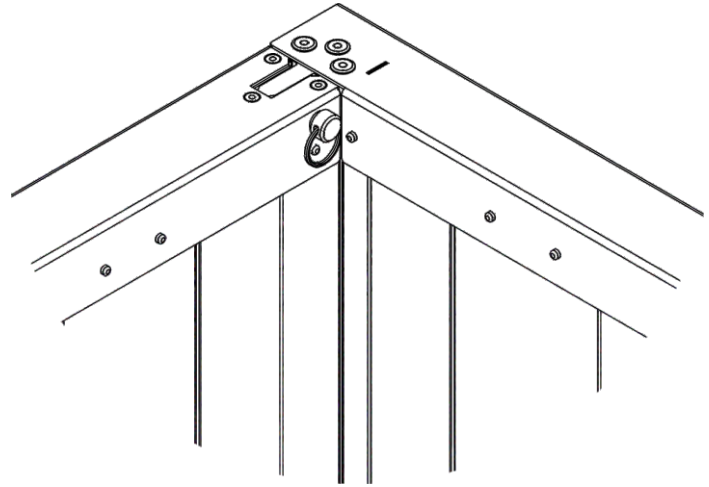
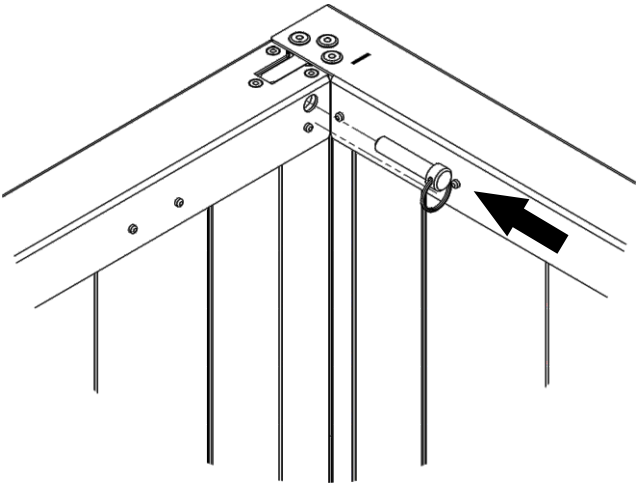

4.1.

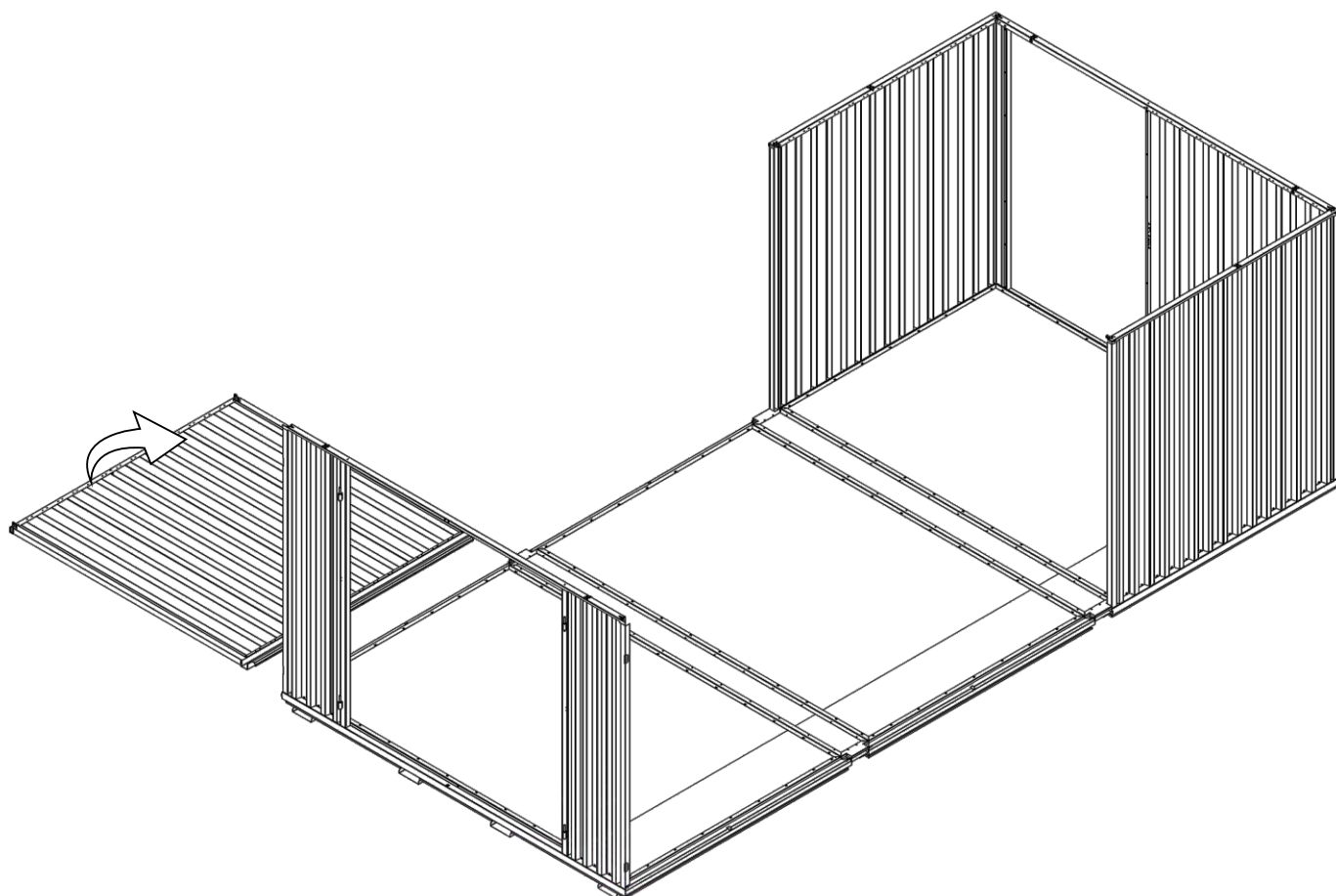
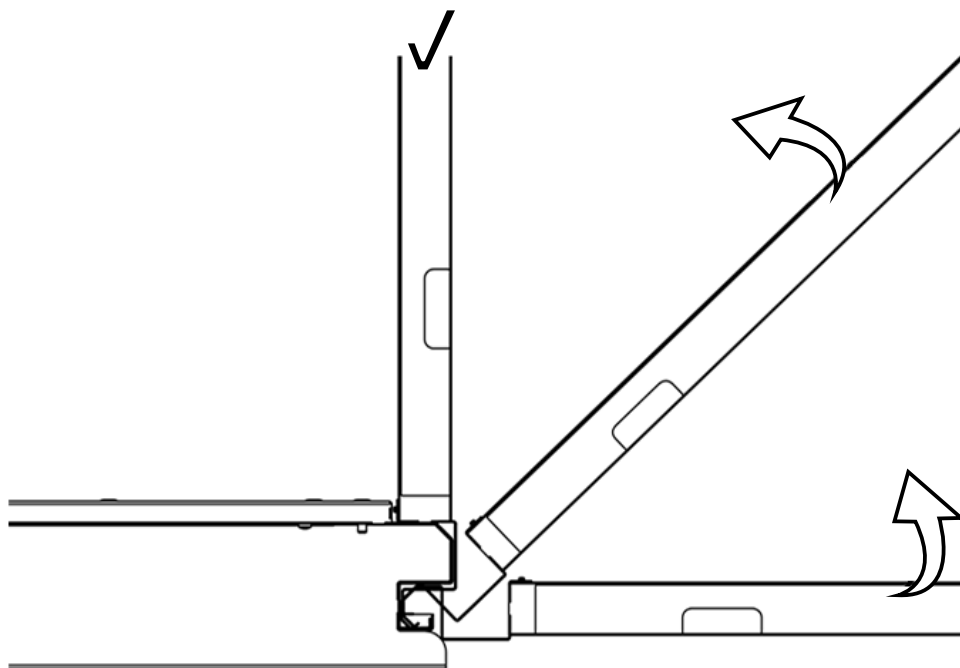

5.1.

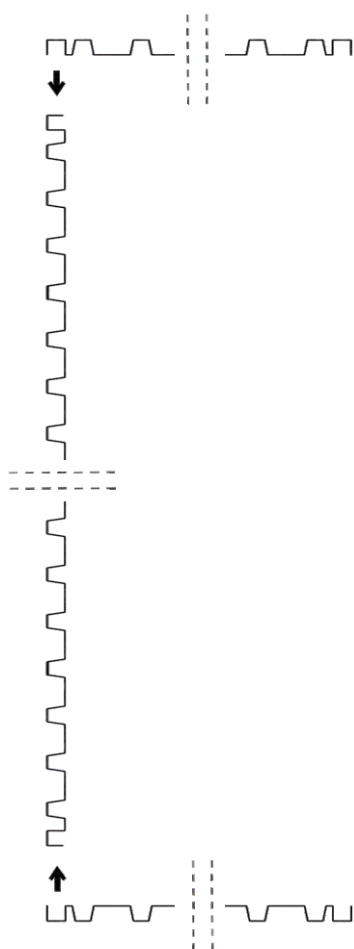
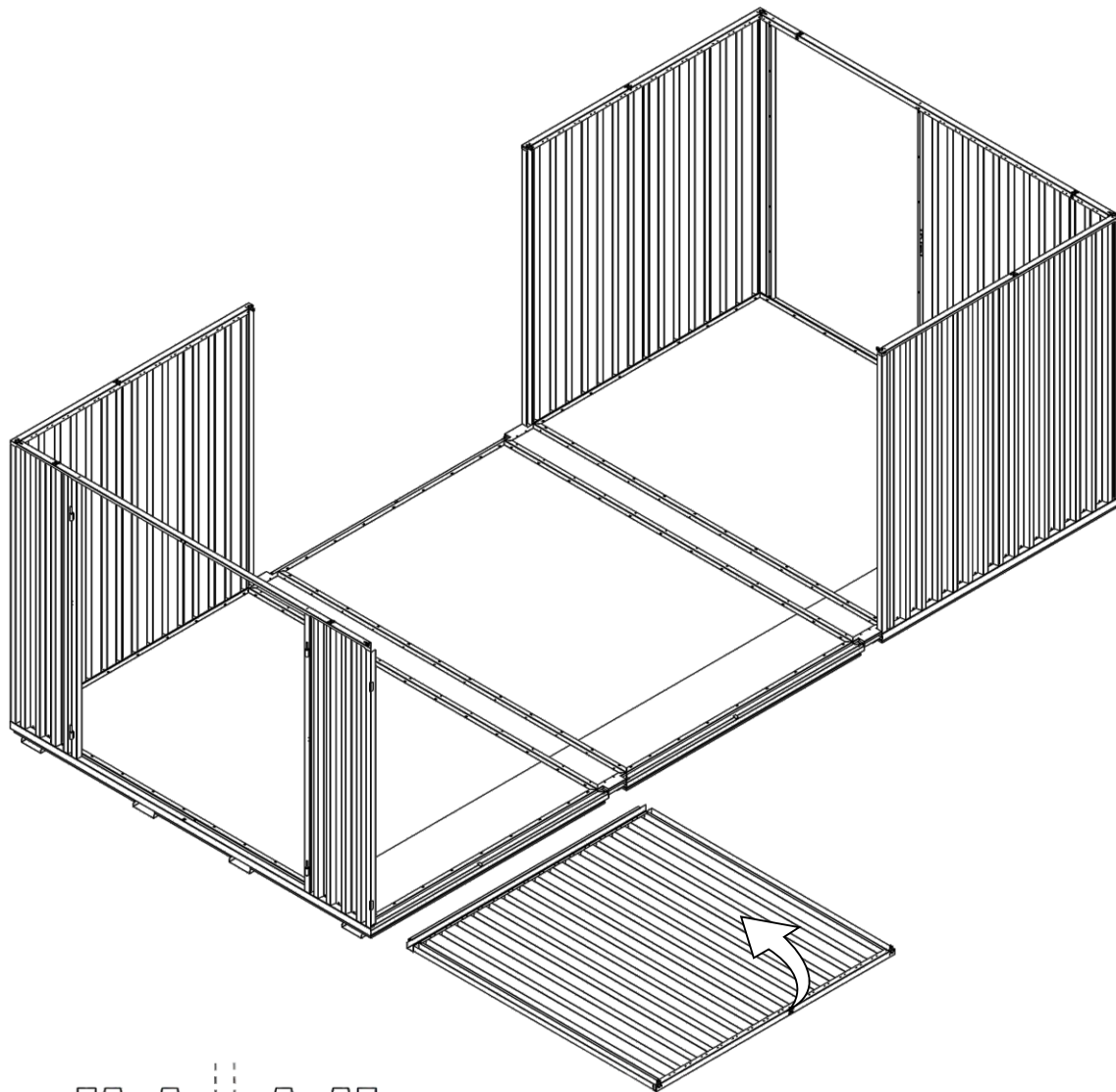

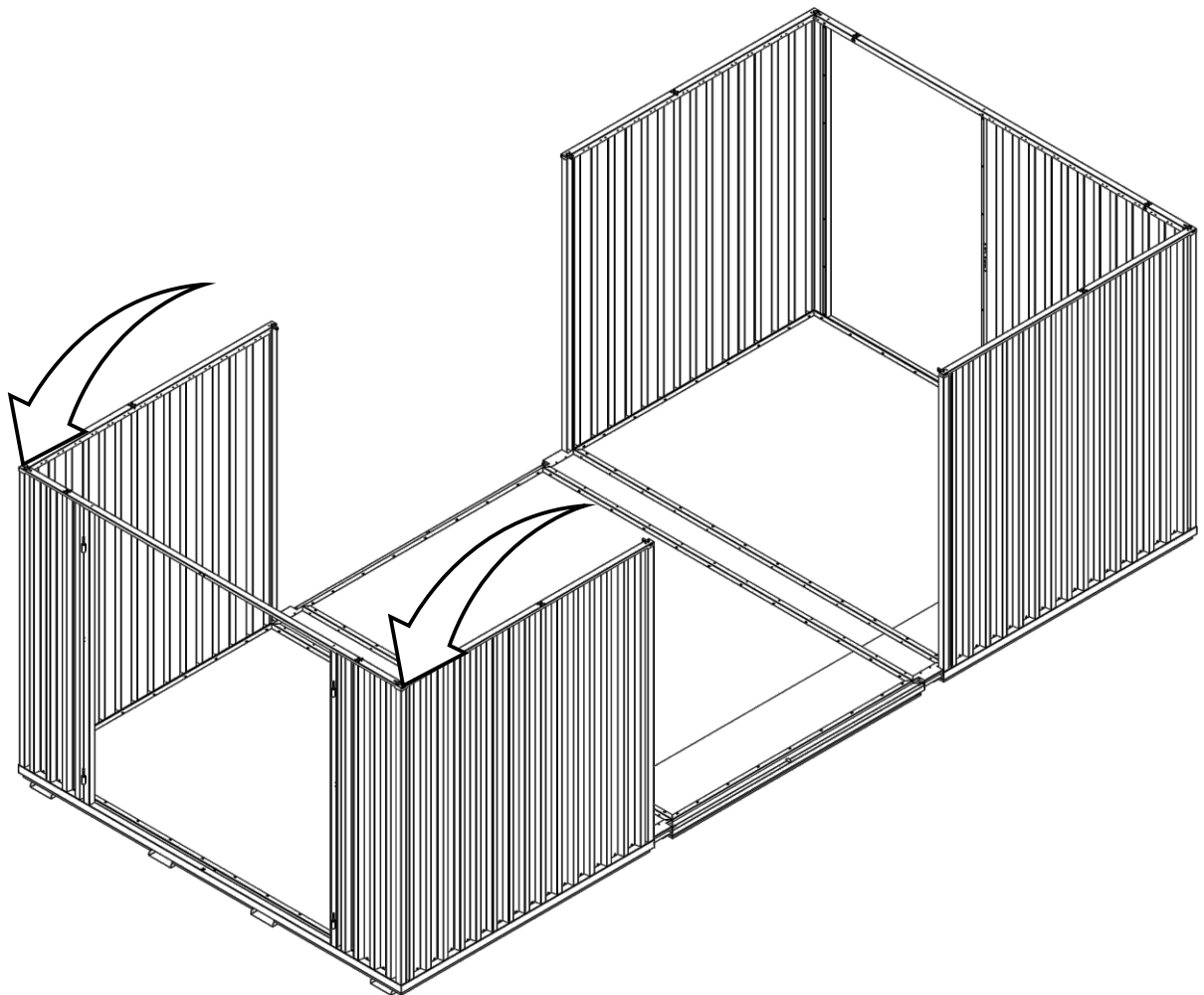
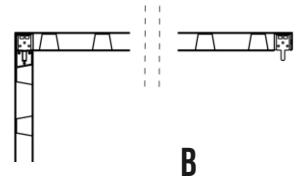
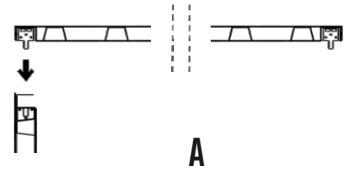
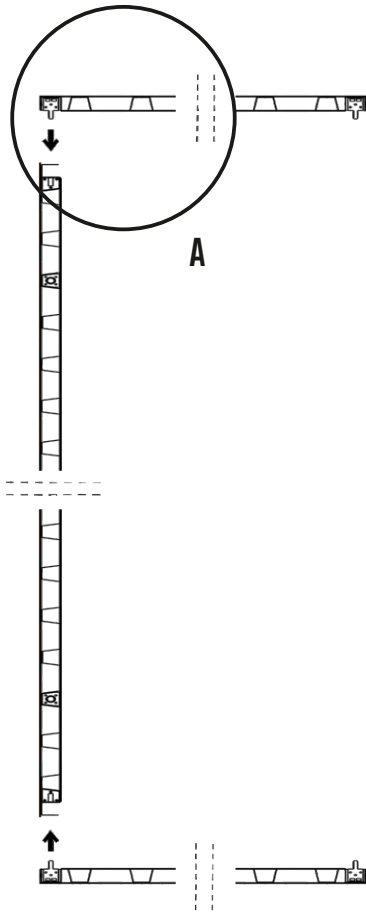
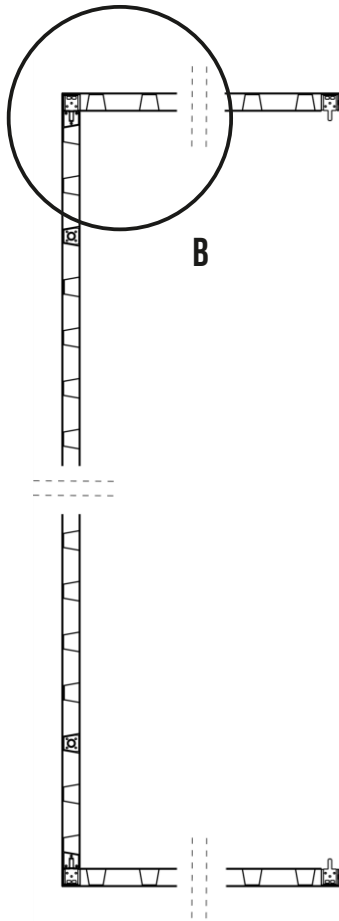

5.2.

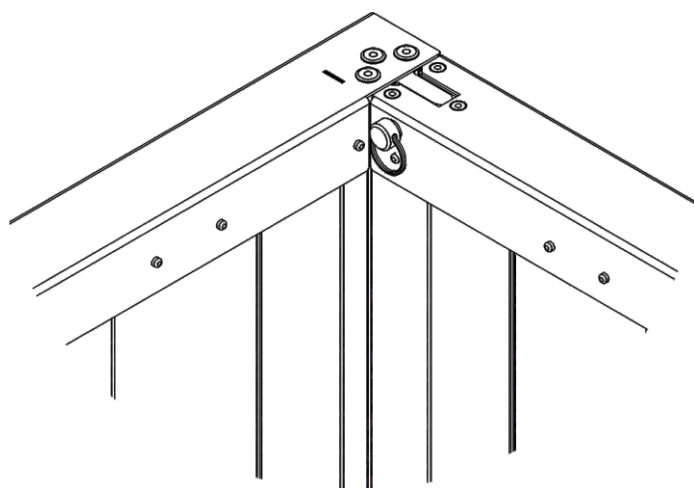
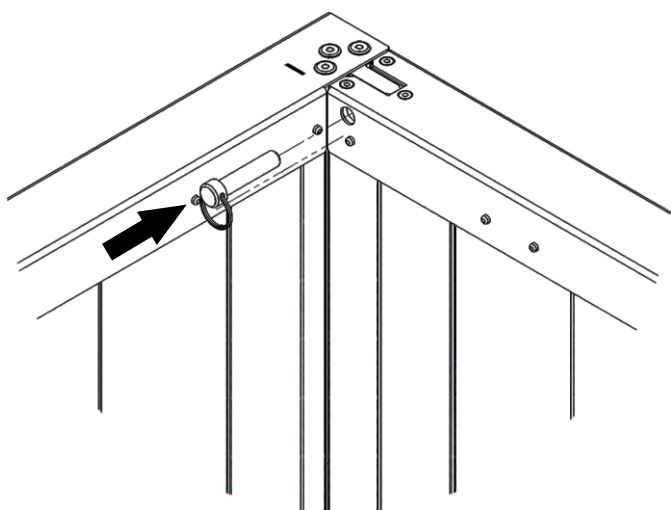
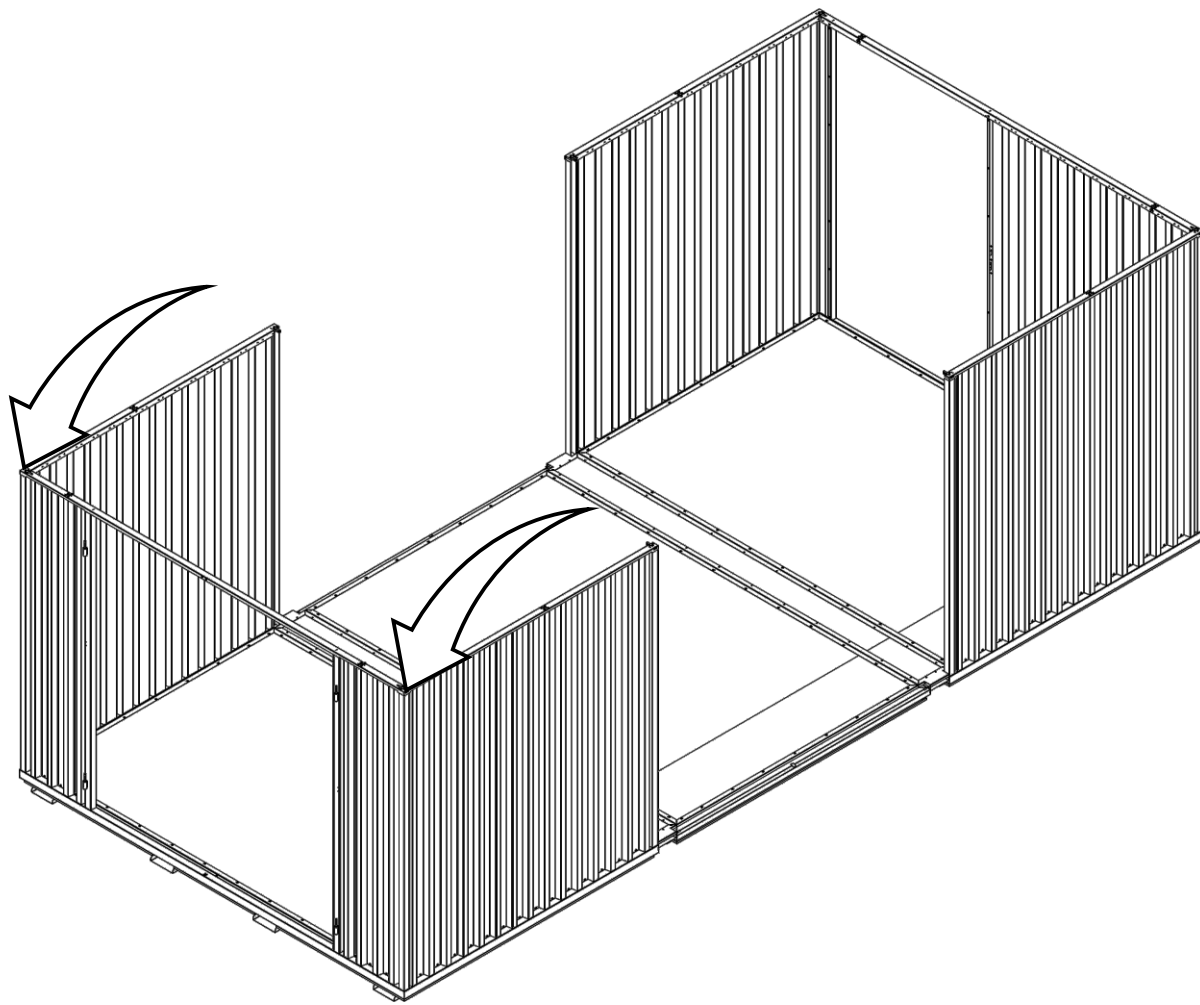

6.1.

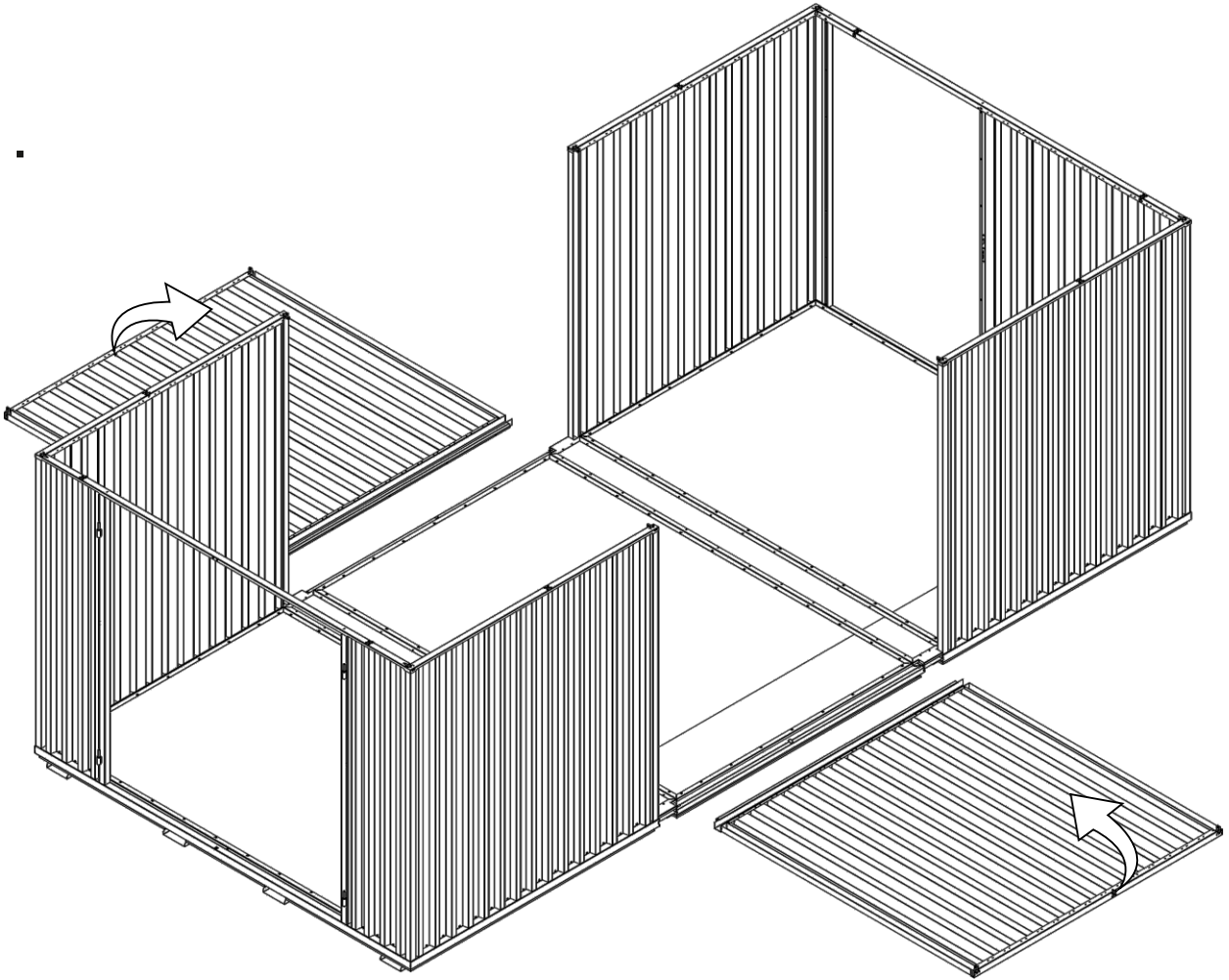

6.2.

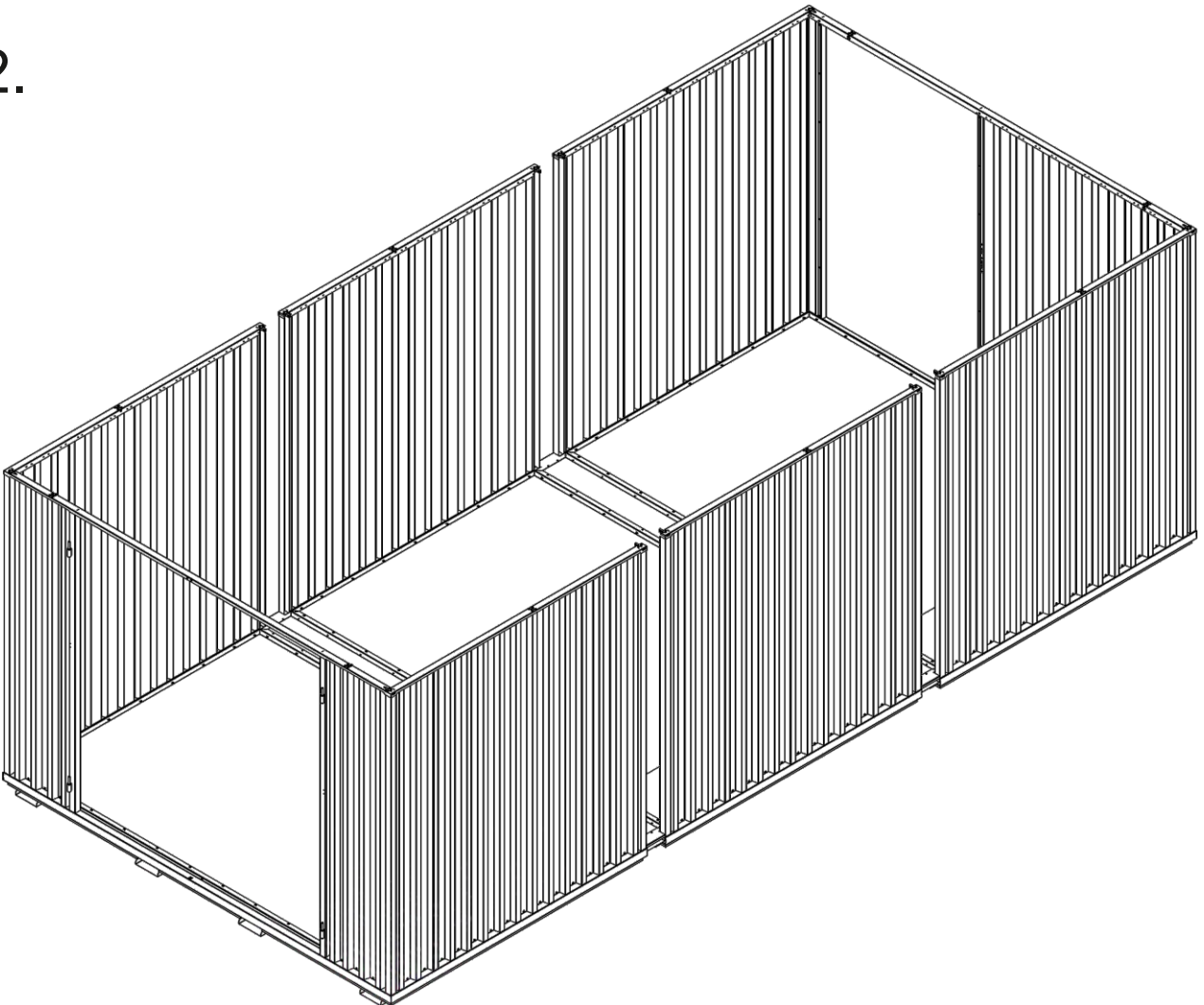

7.1.

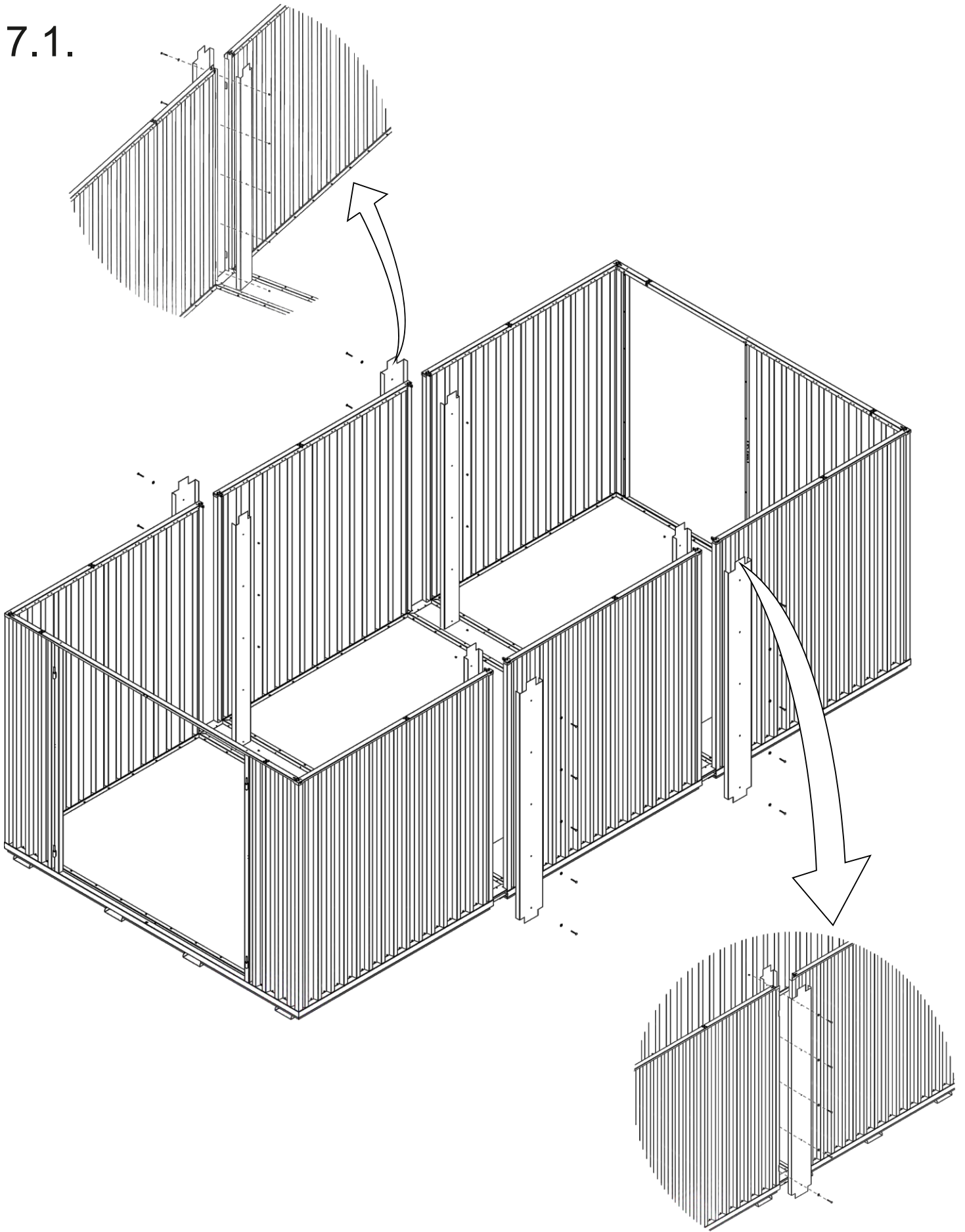



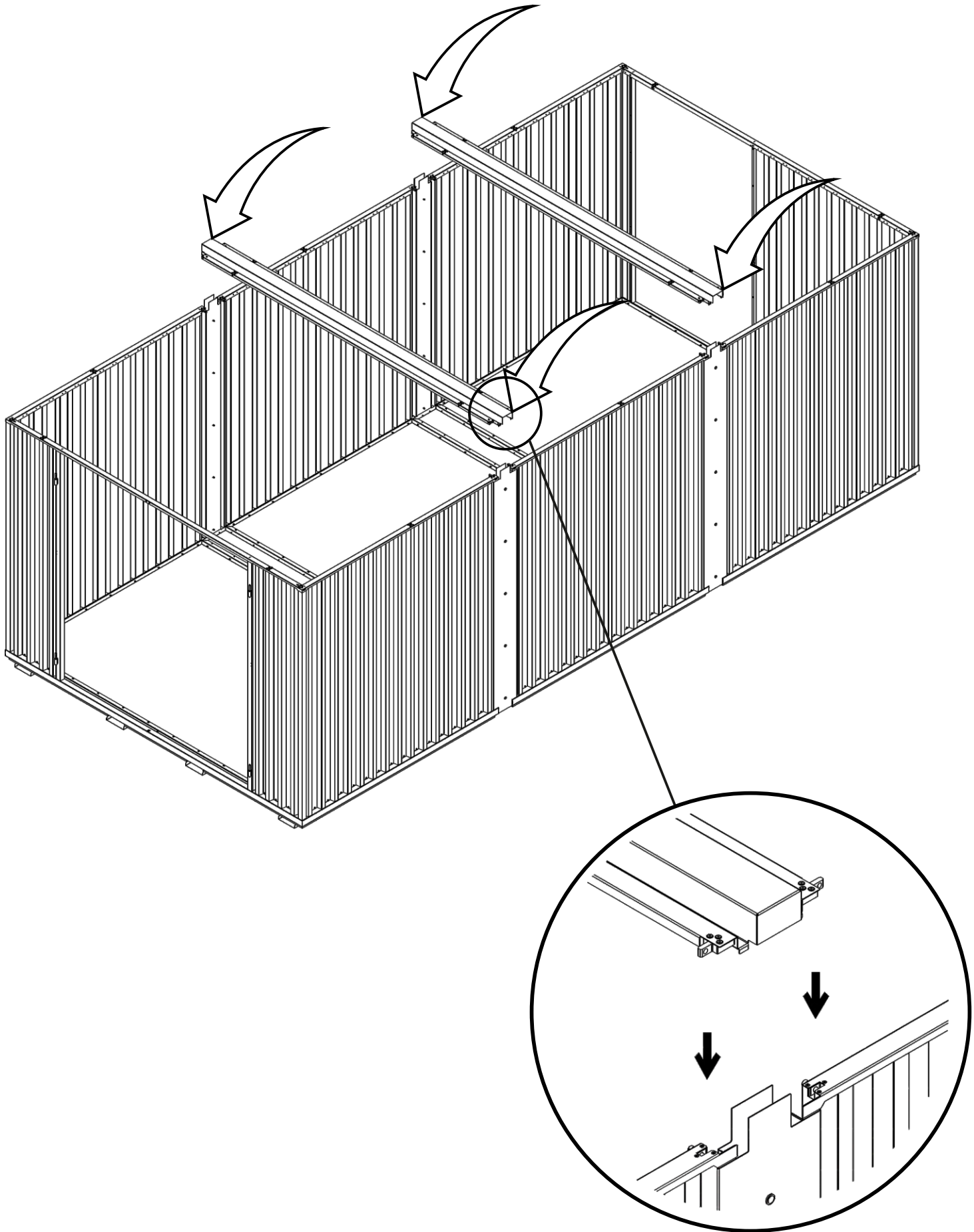

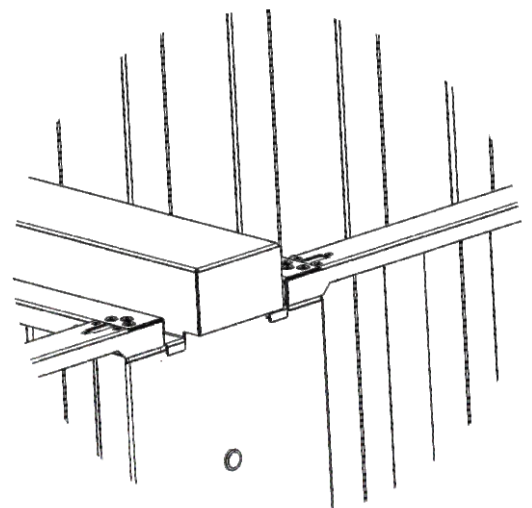
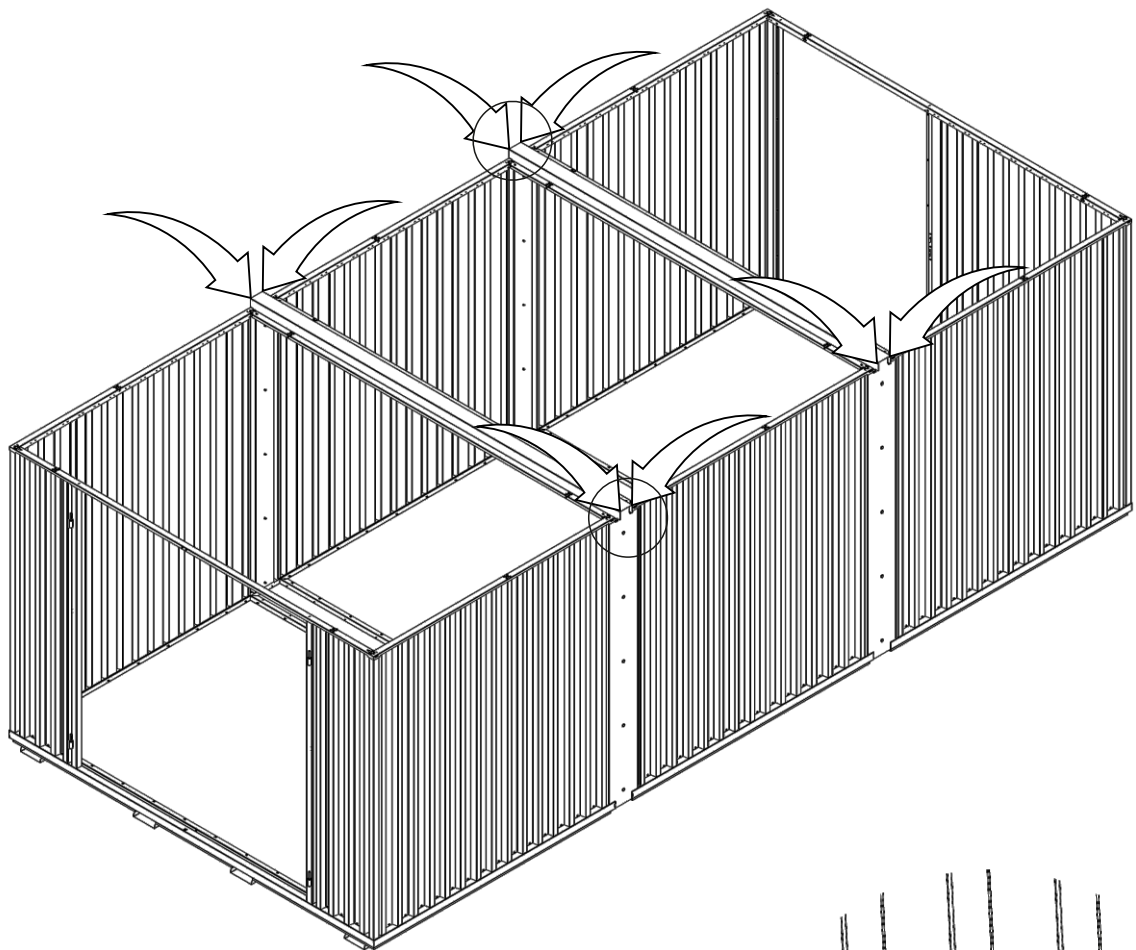
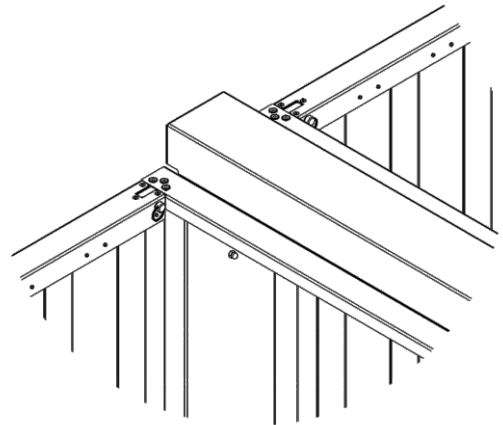
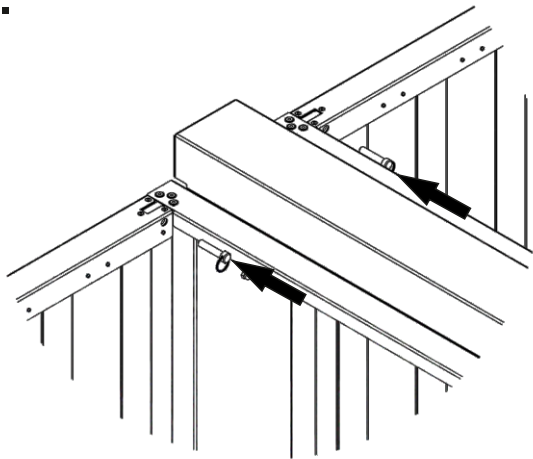

8.1.



8.2.



9.1.

 Mass ...Kg.	 Total ... Kg.	 1640 MM	Model Code Production Tracking Code   		
--	--	--	---	---	---

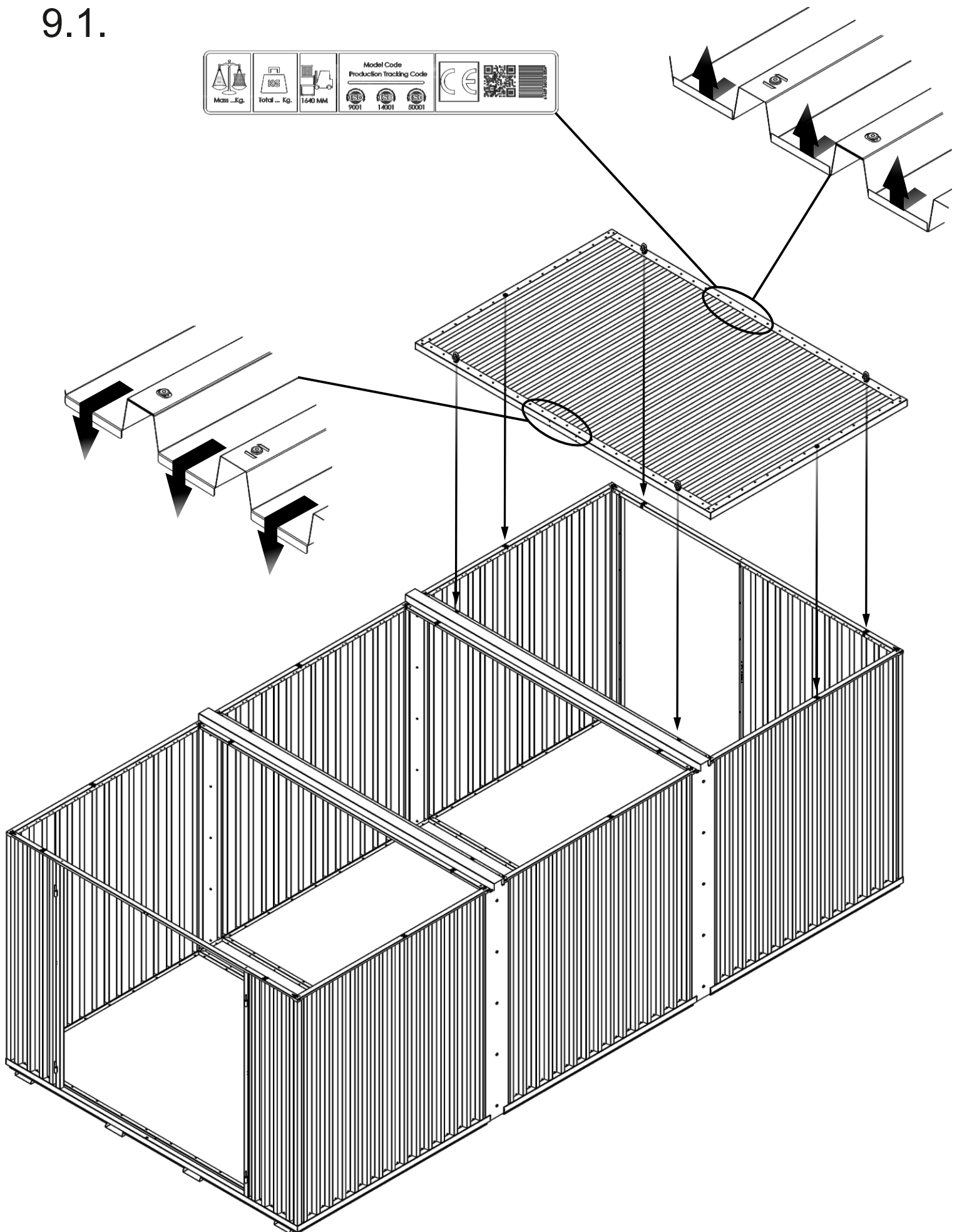

9.2.

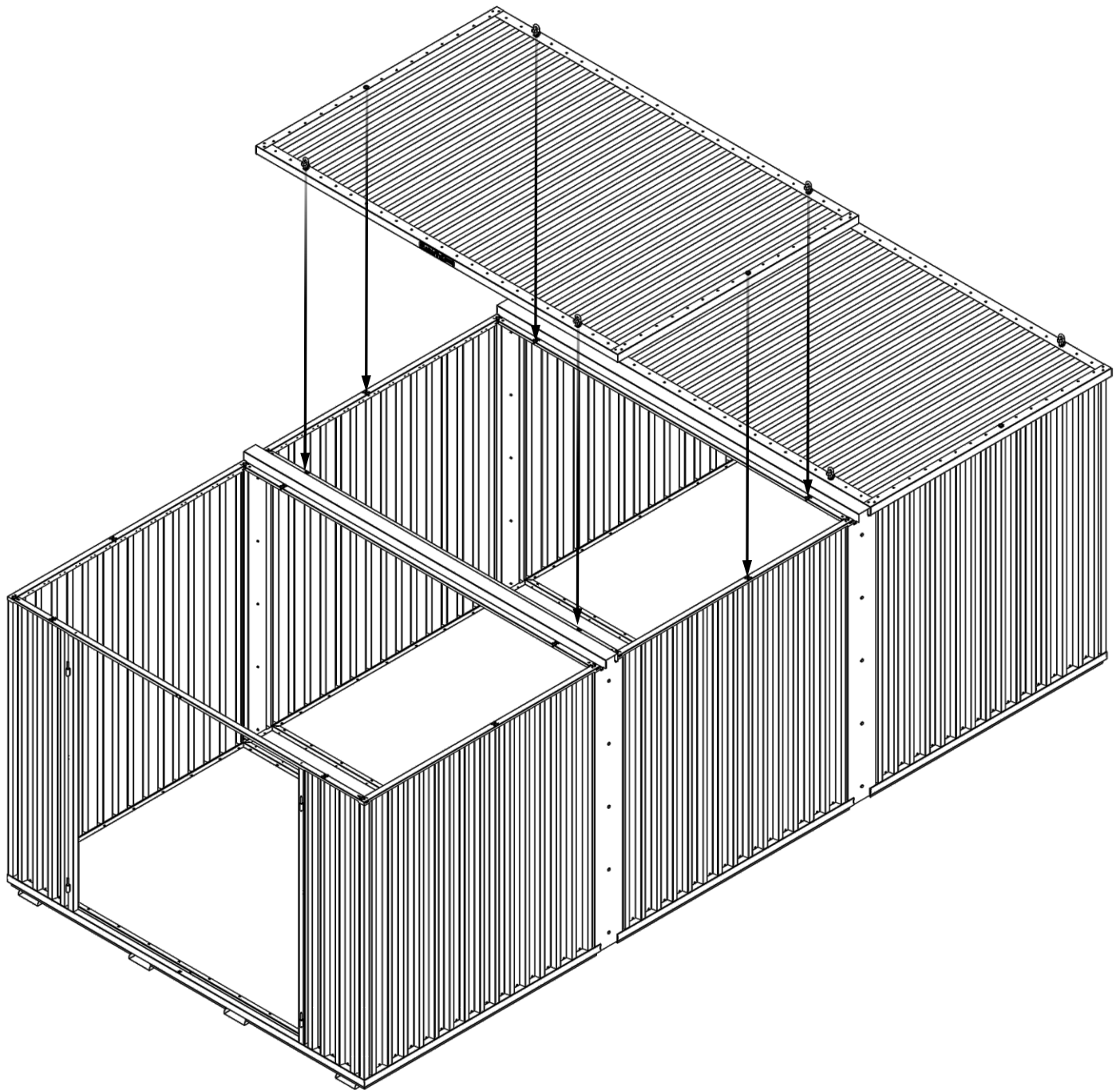

9.3.

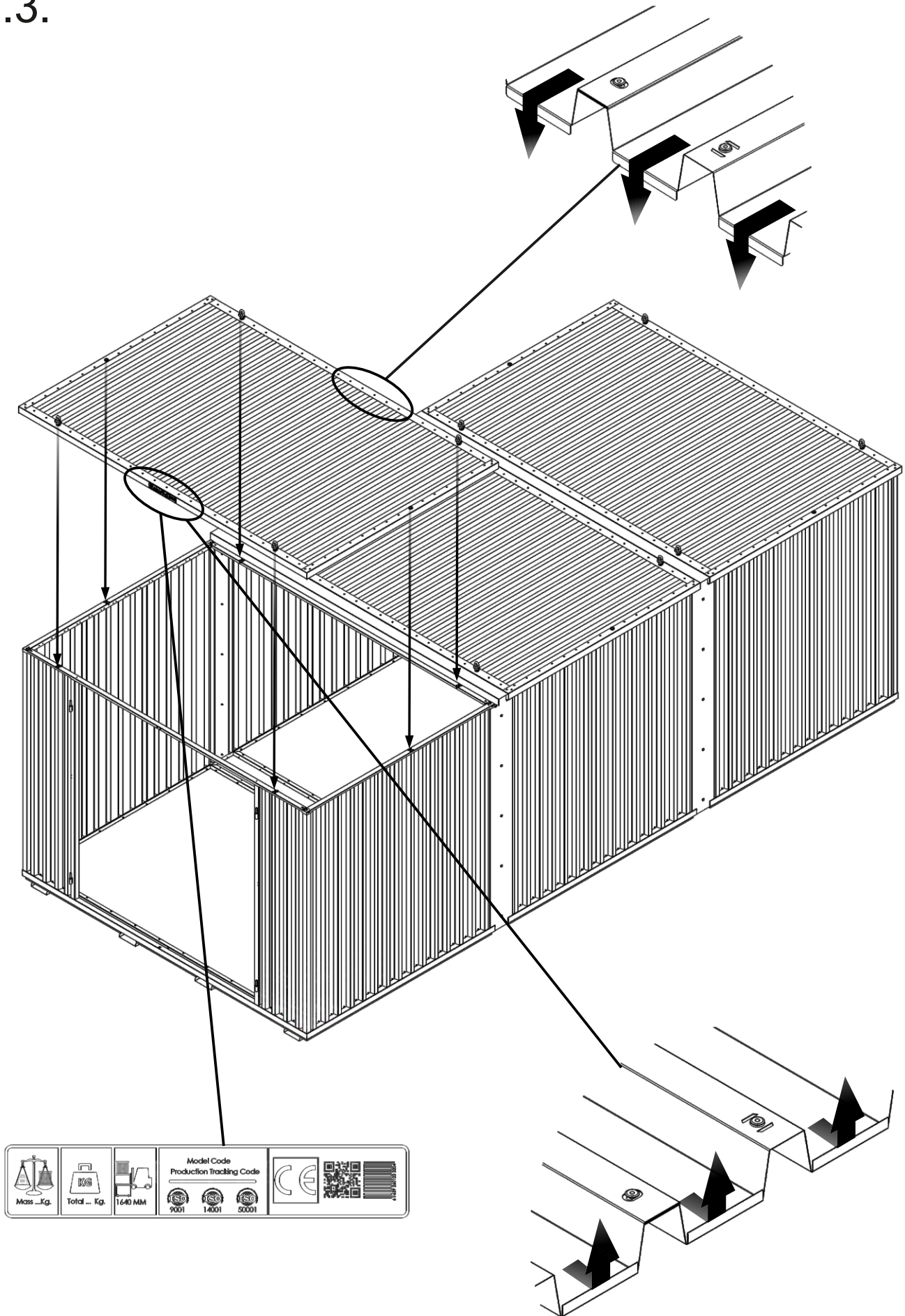

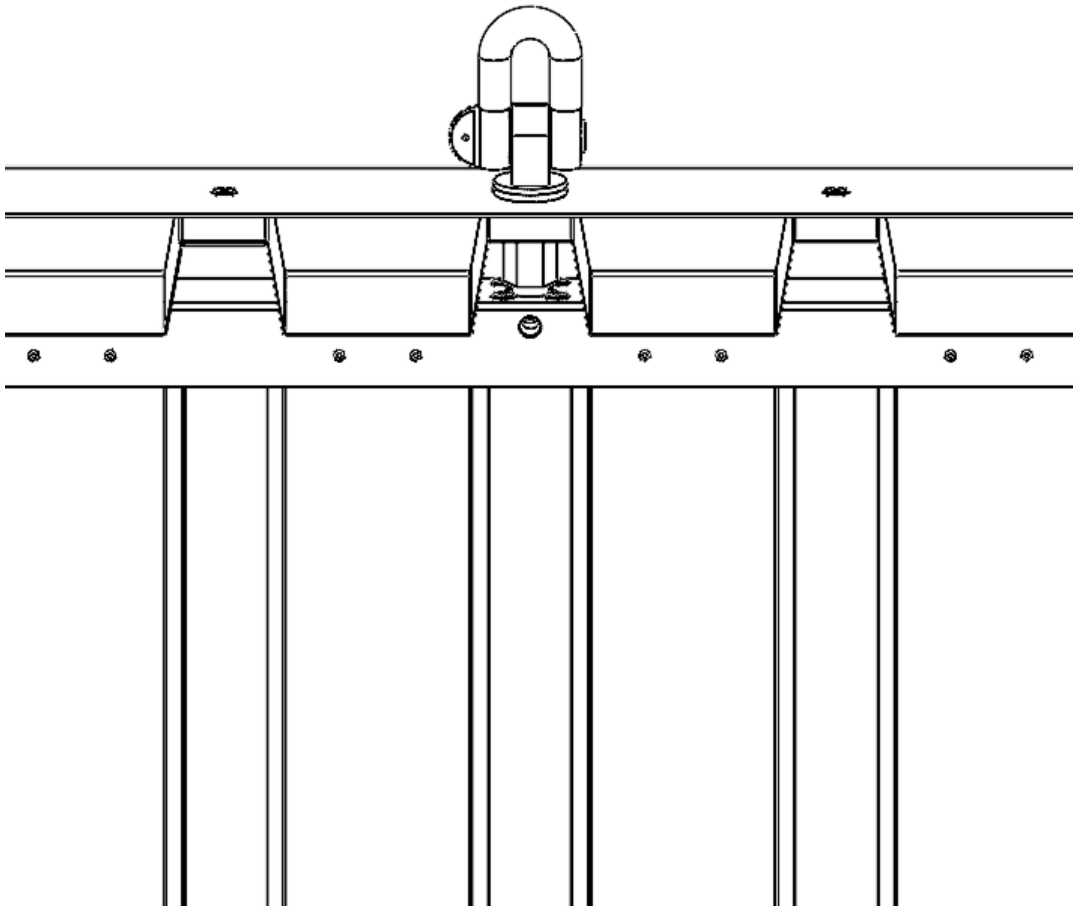
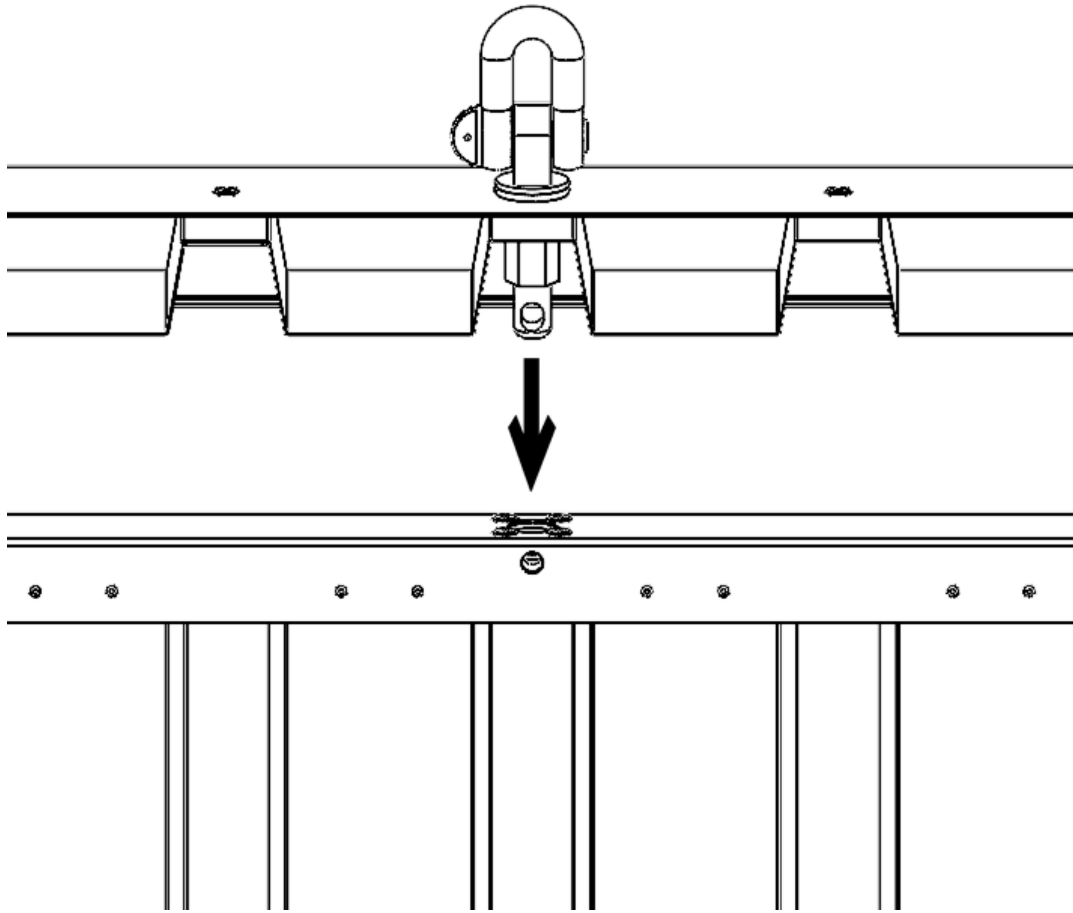

9.4.

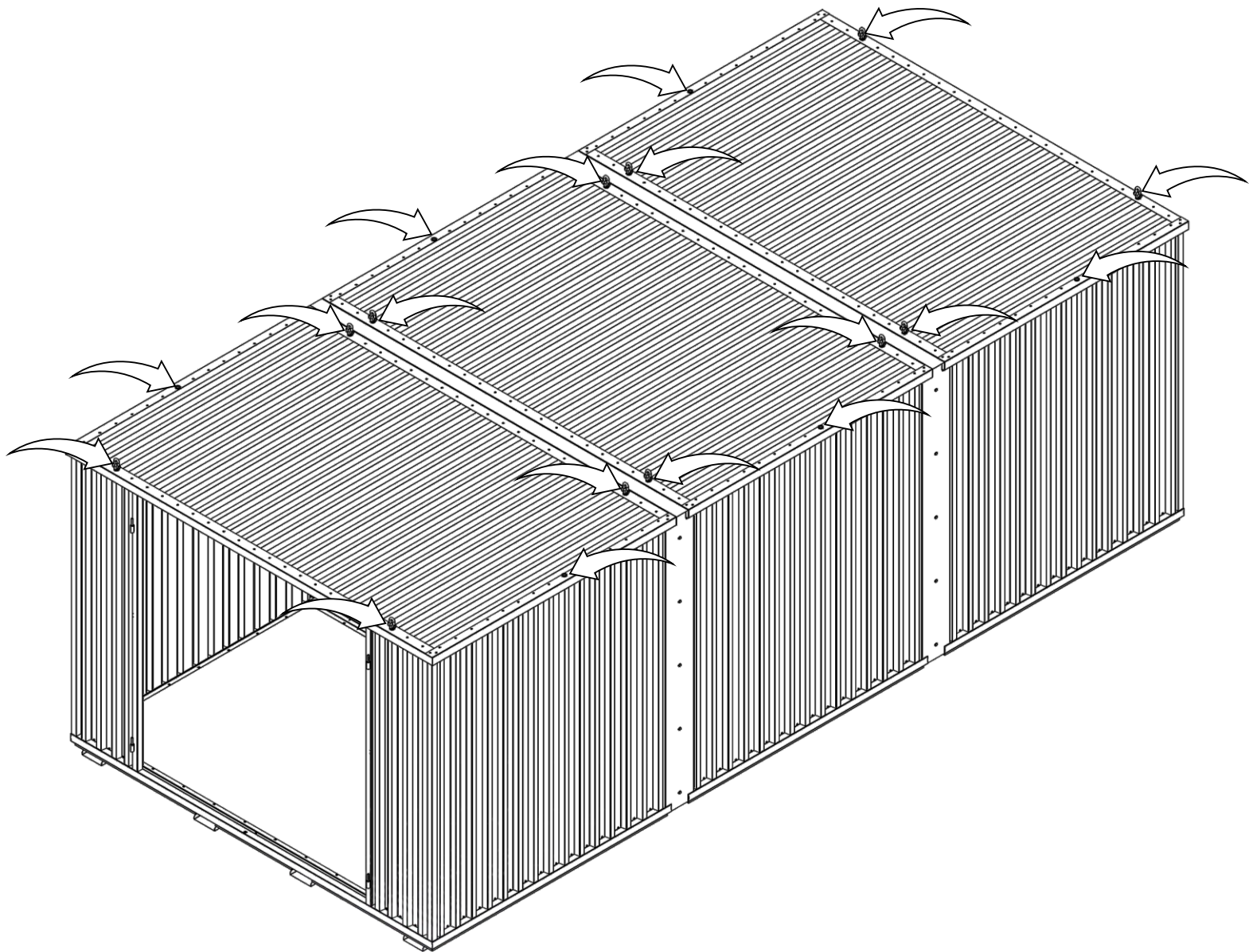

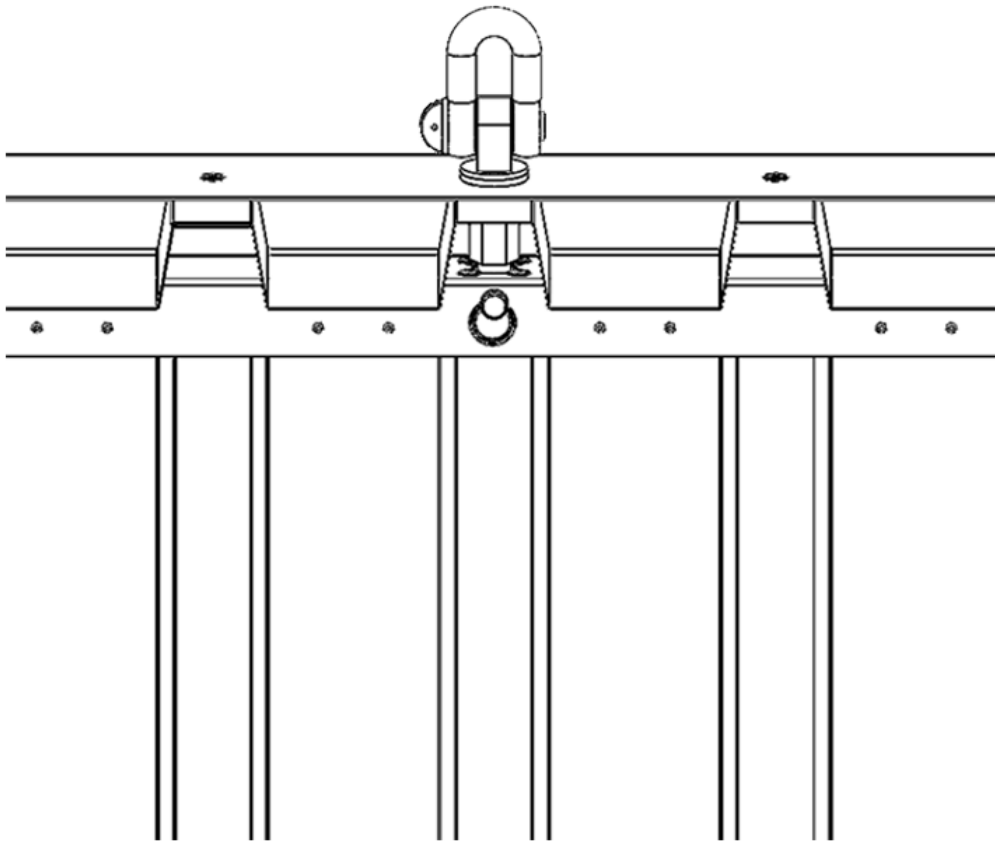
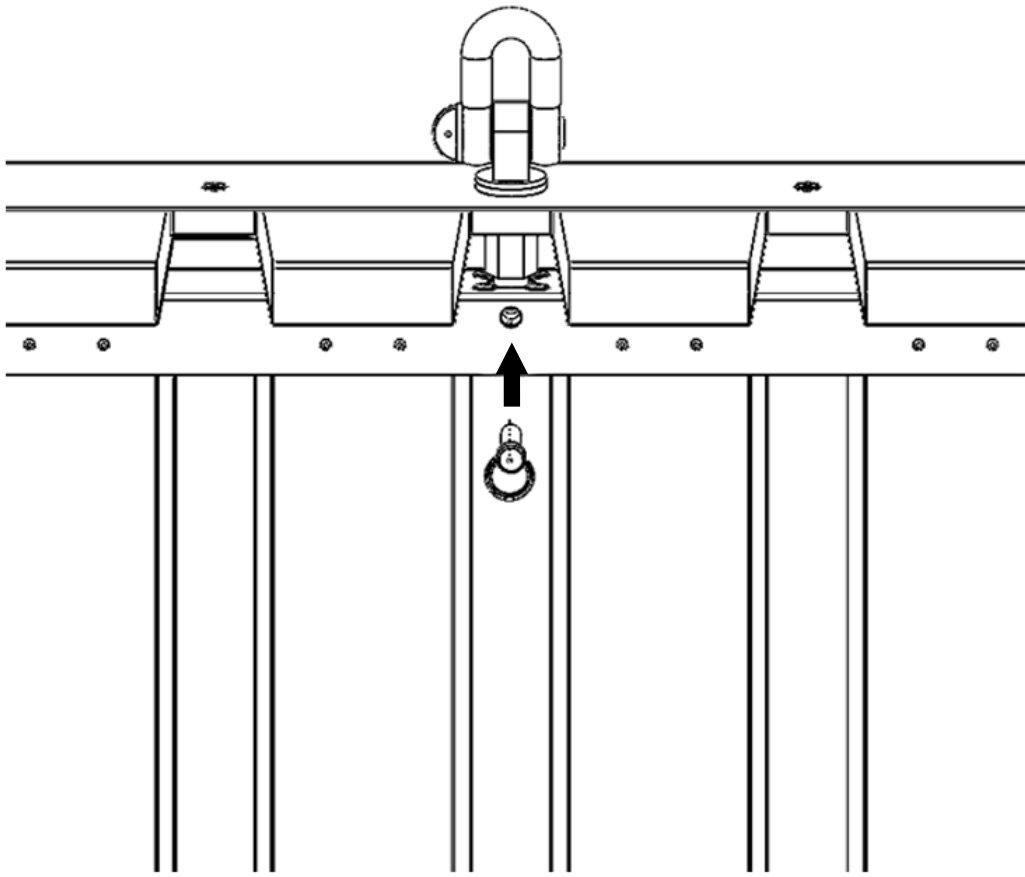

10.1.

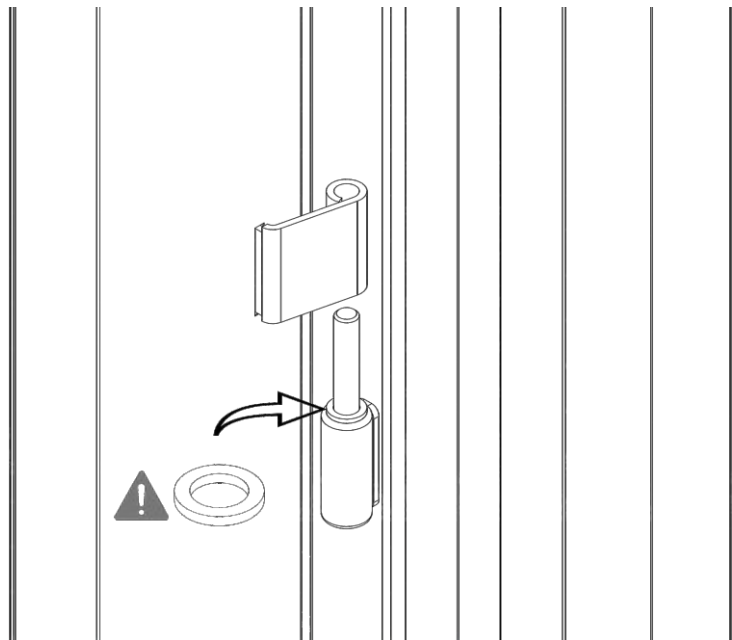
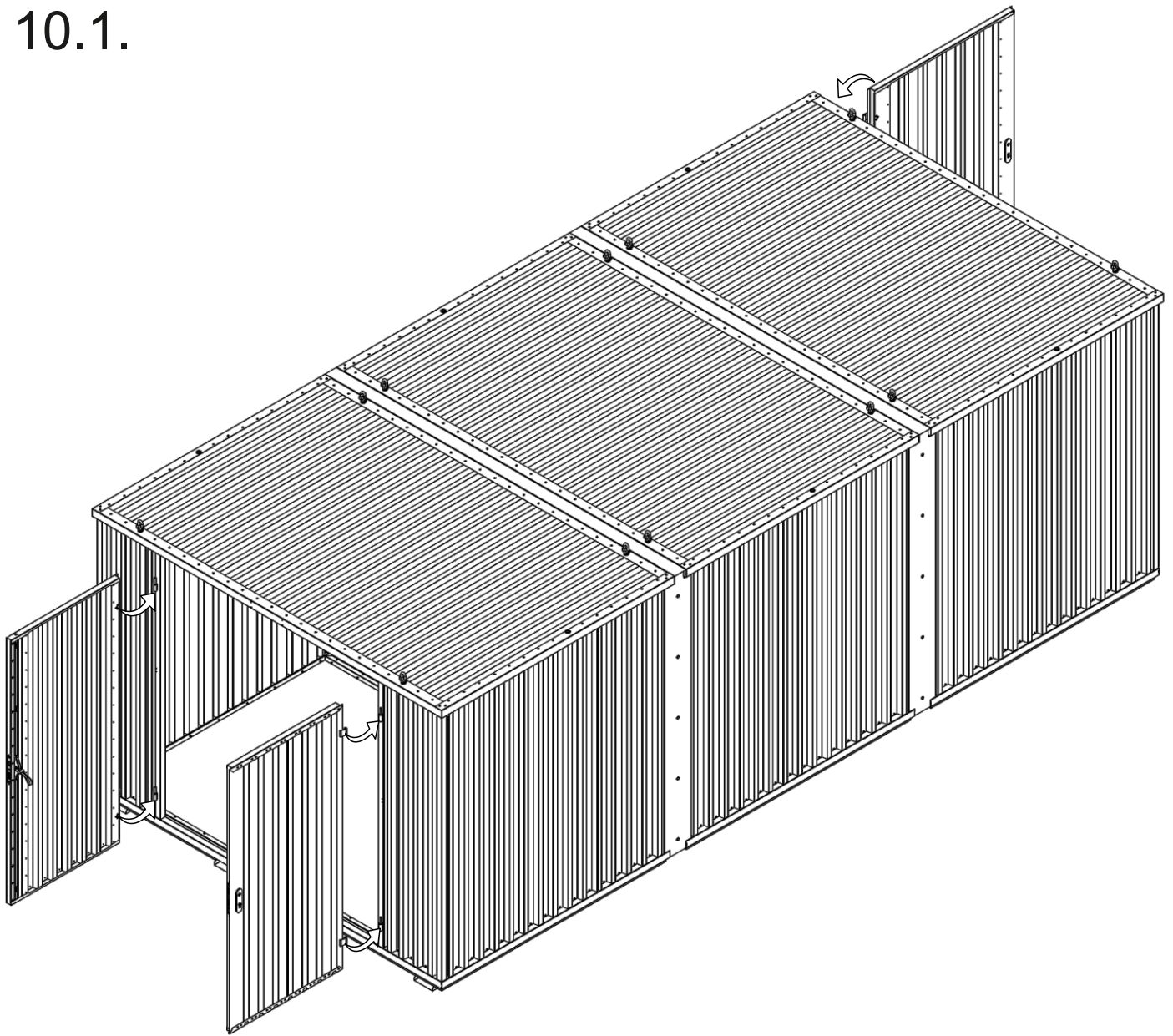

10.2.

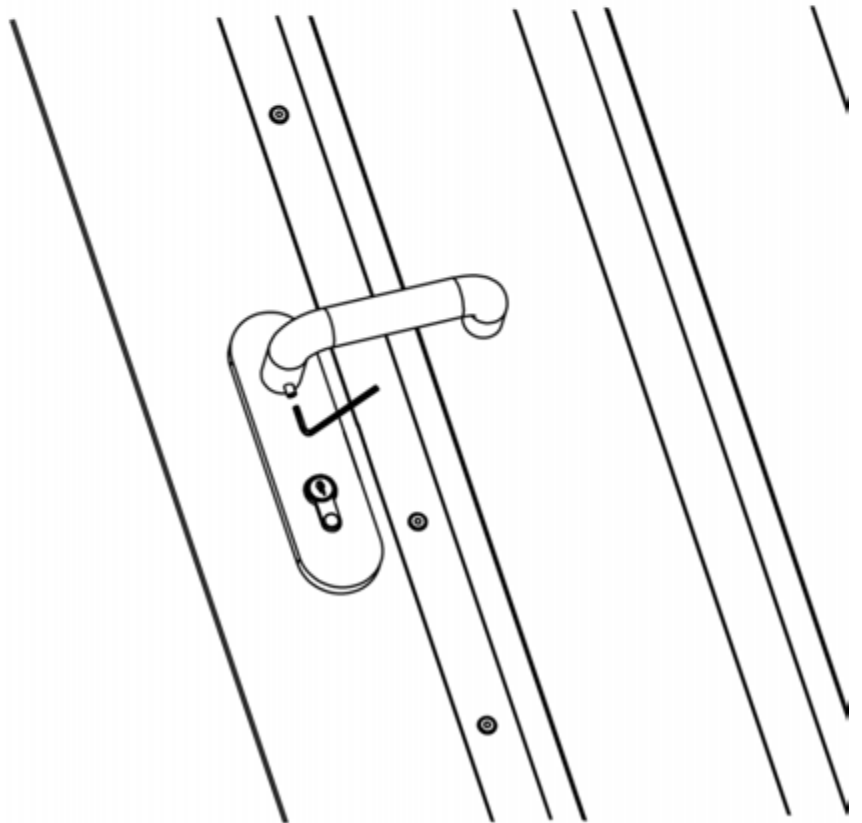
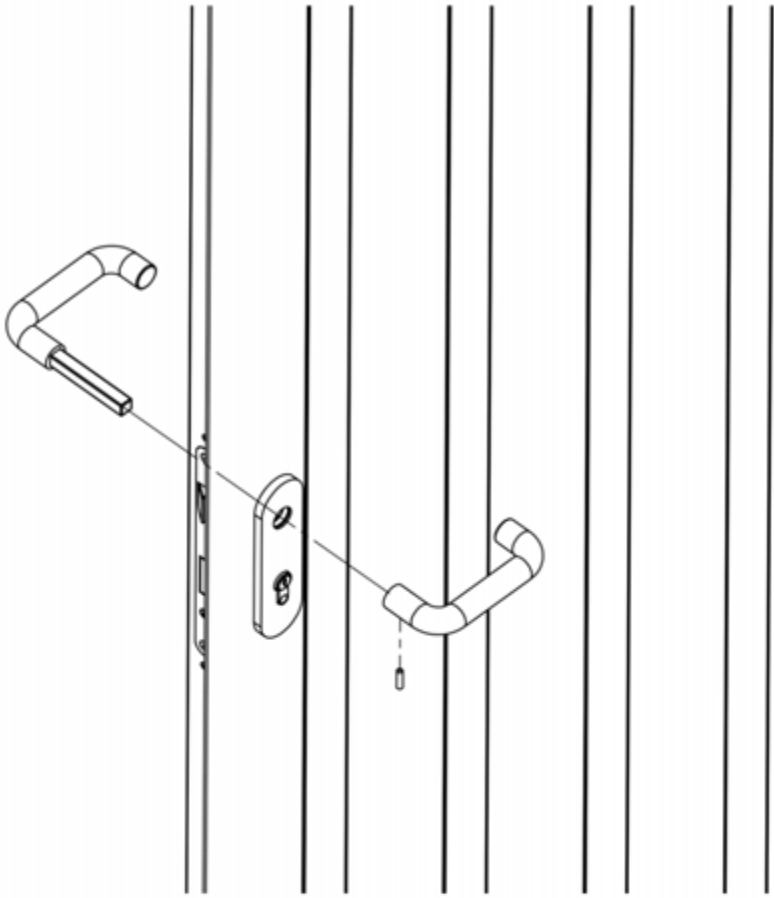

11.1.

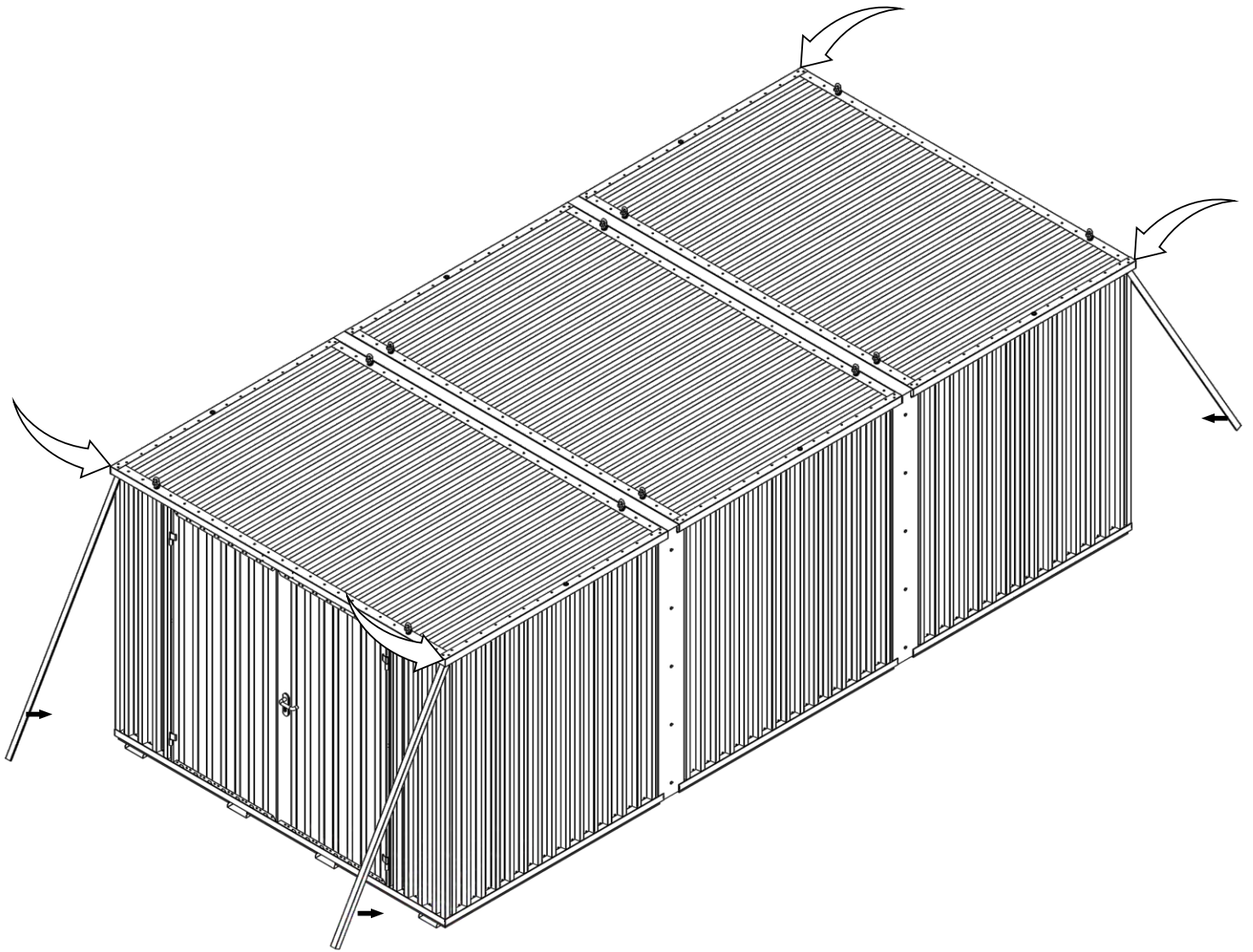

12.1.

