

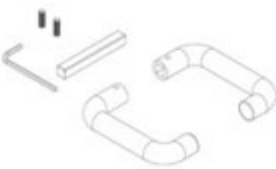



PRODUCT CODE :303.110.430.450



	20 pcs.
	1 pcs.
	1 pcs.
	10 pcs.
	10 pcs.
	10 pcs.

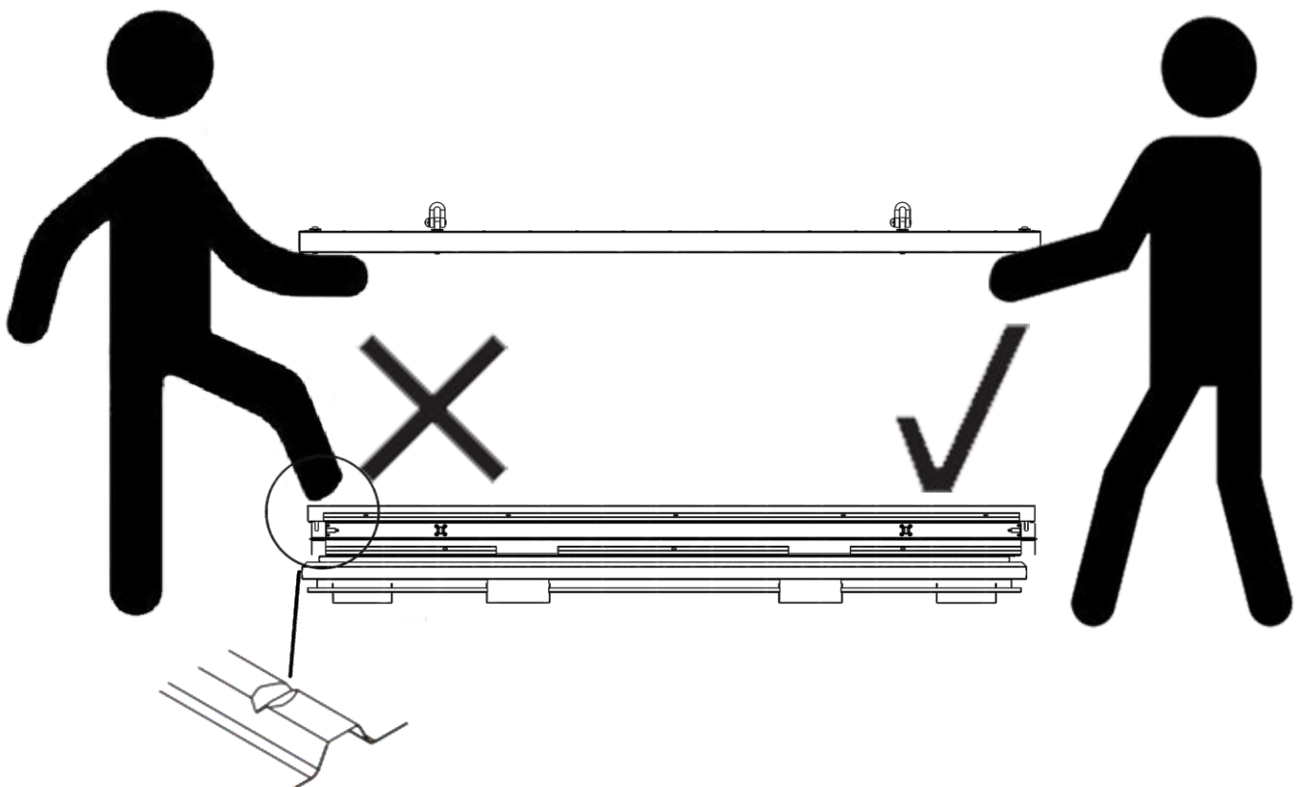
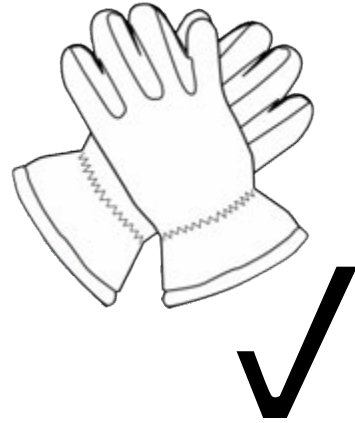

1.1.

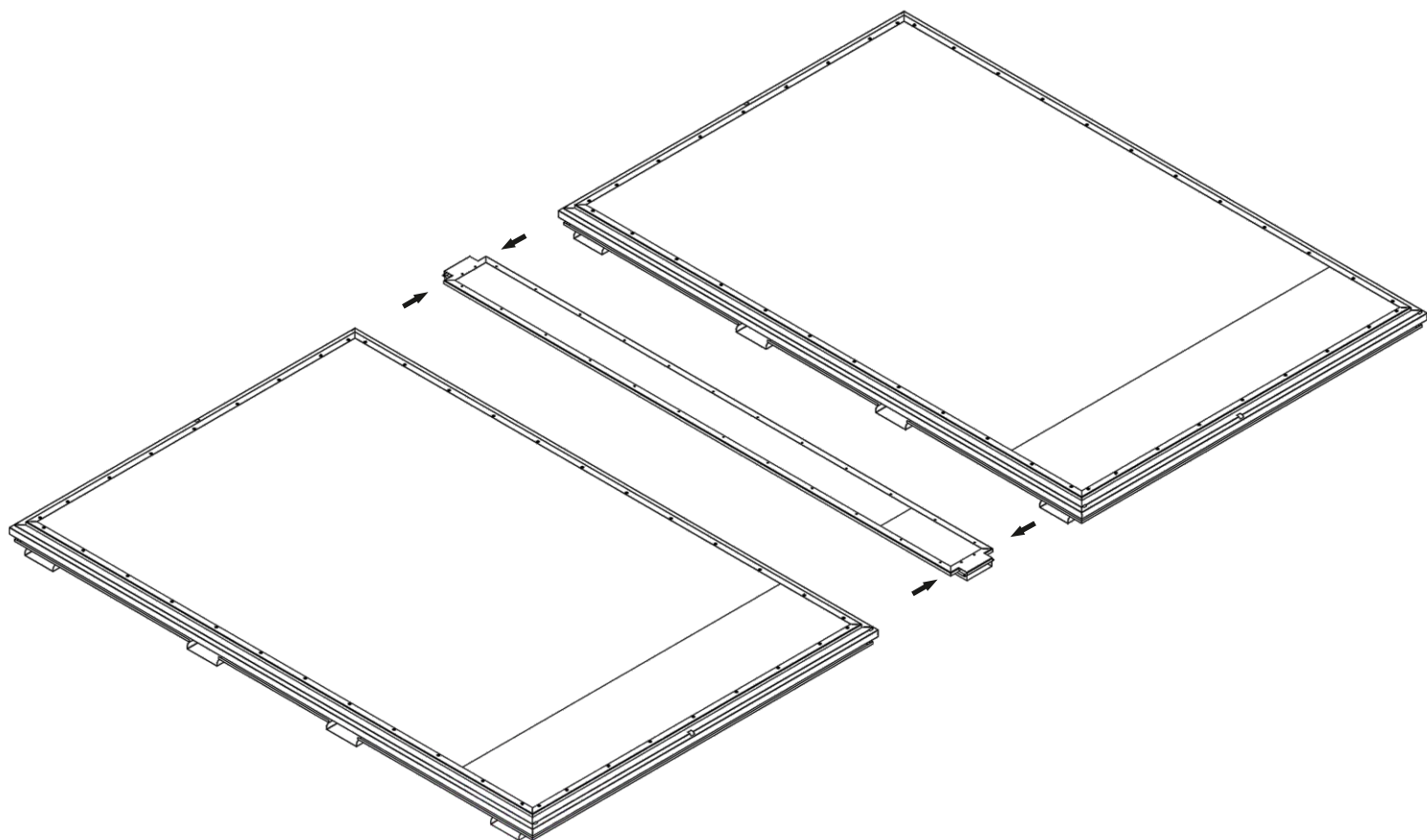

1.2.

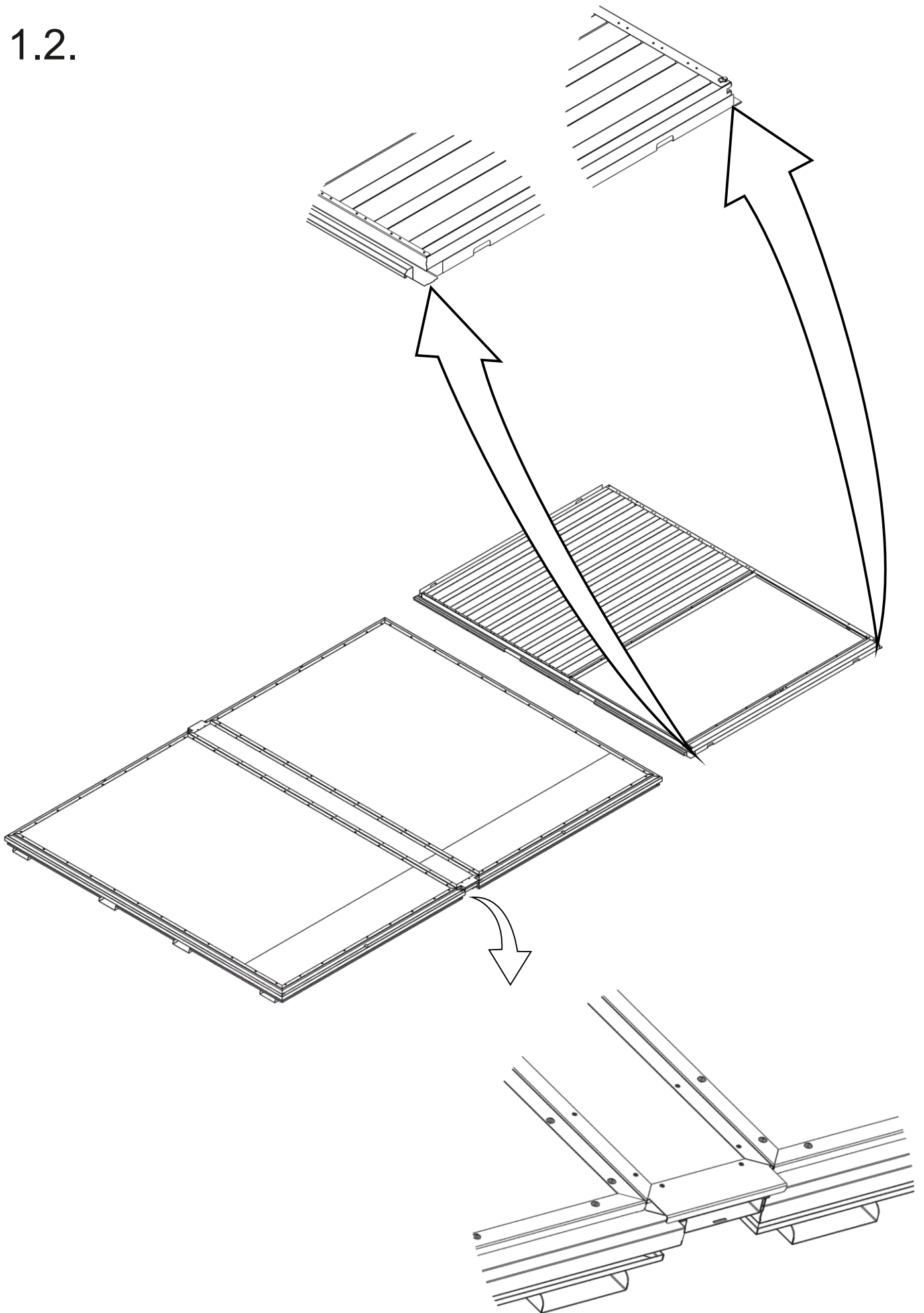

2.1.

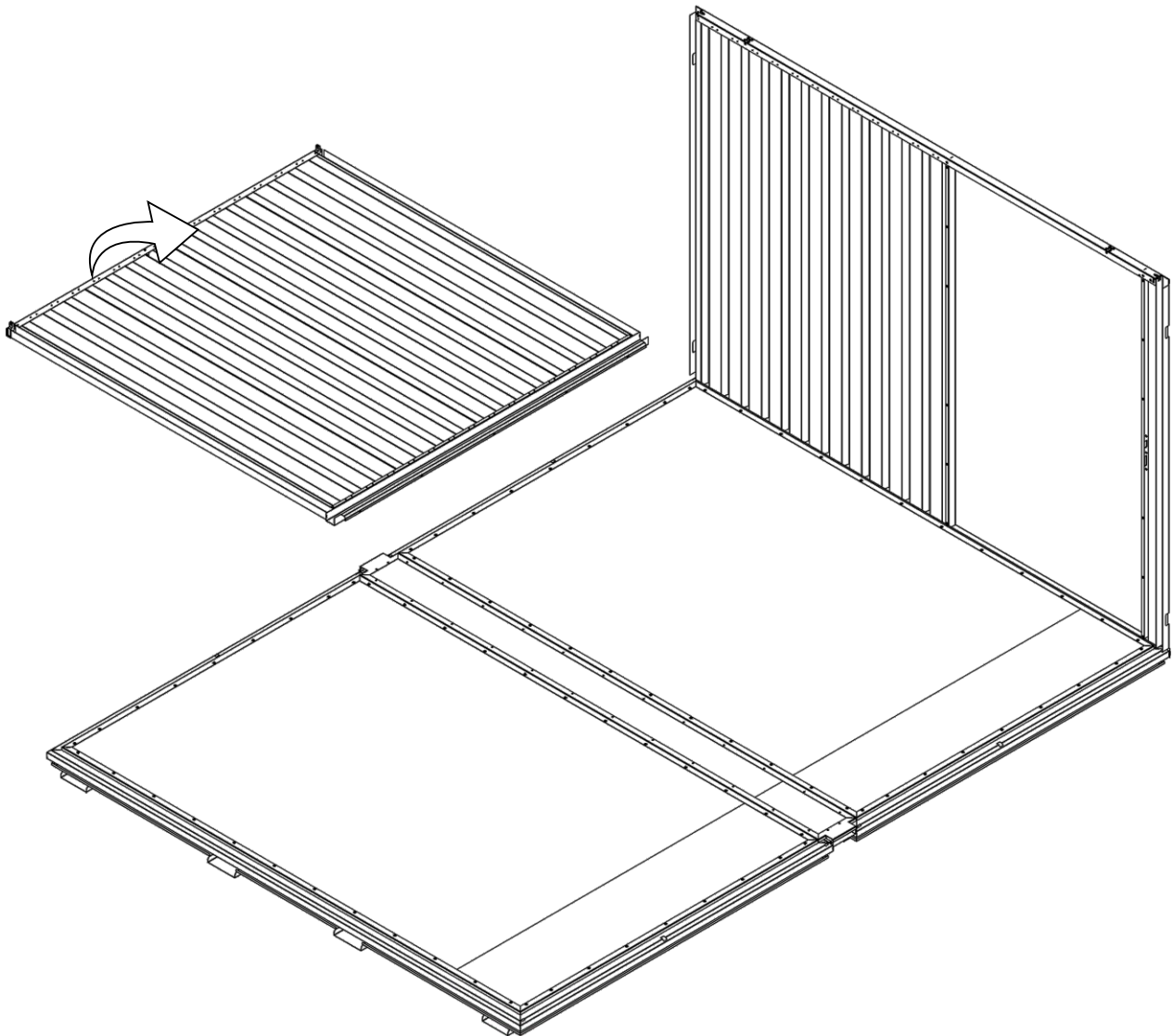
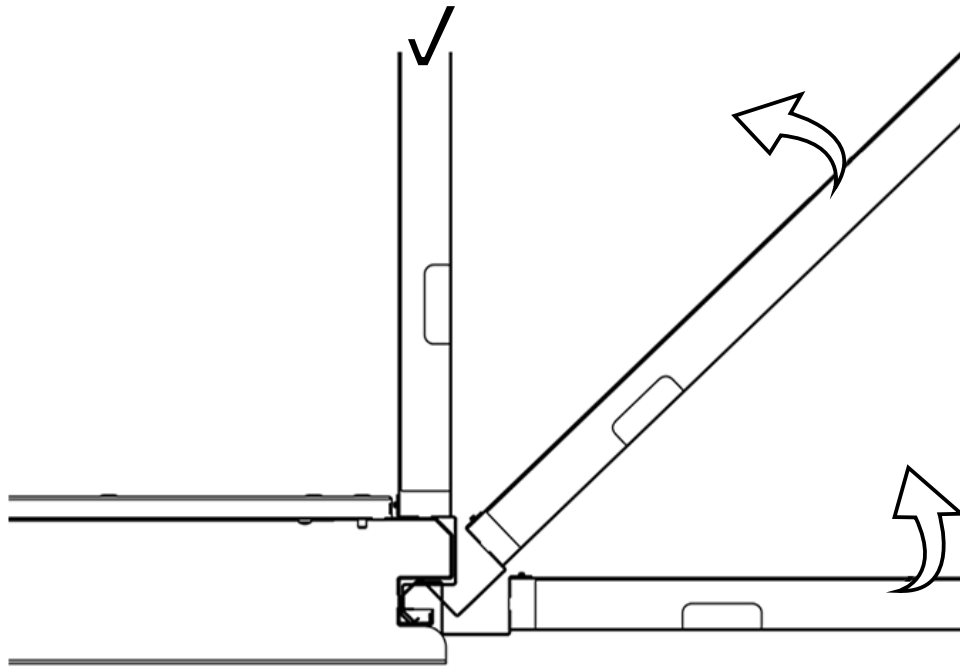

3.1.

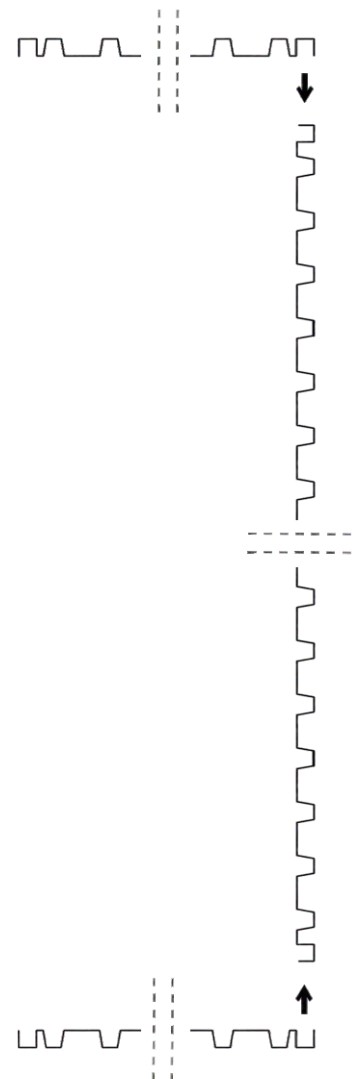
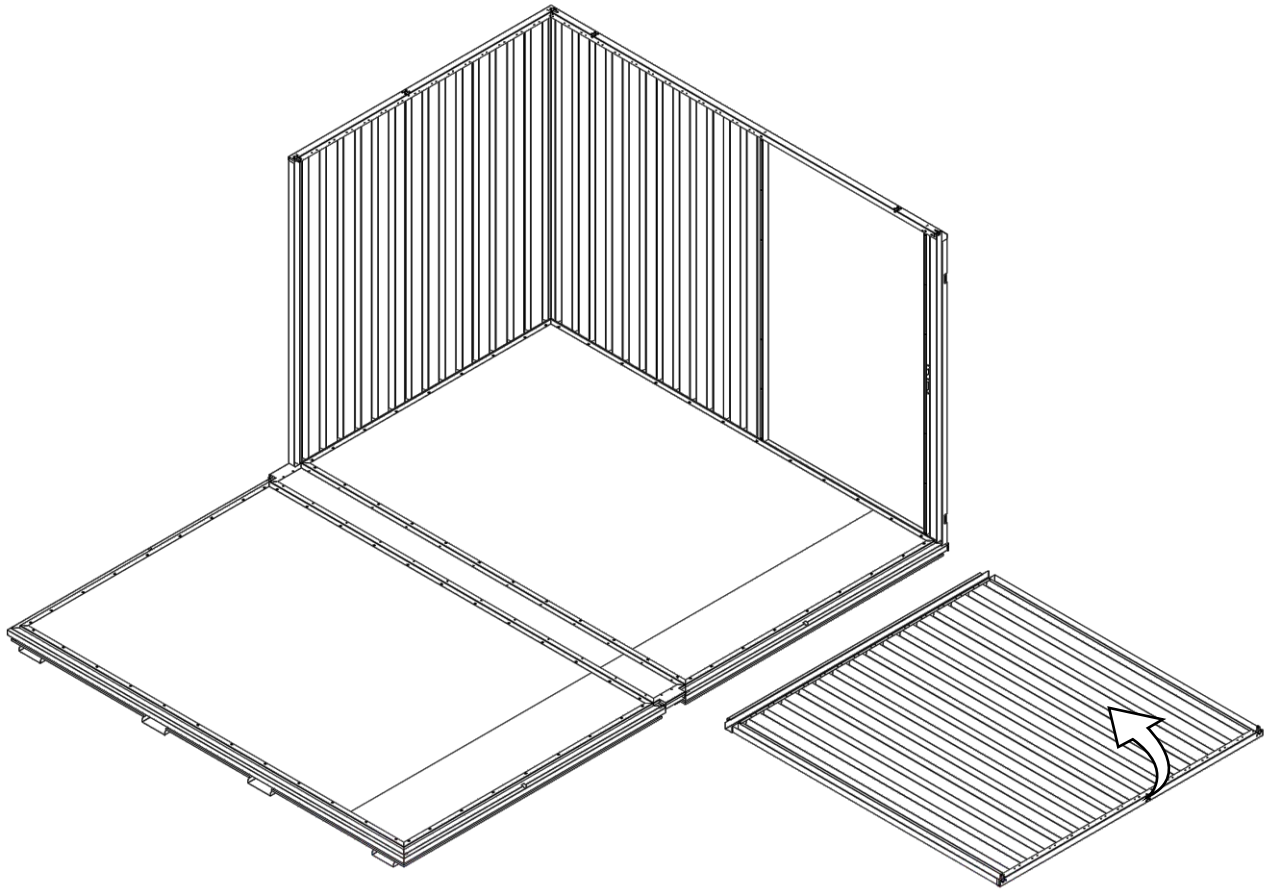

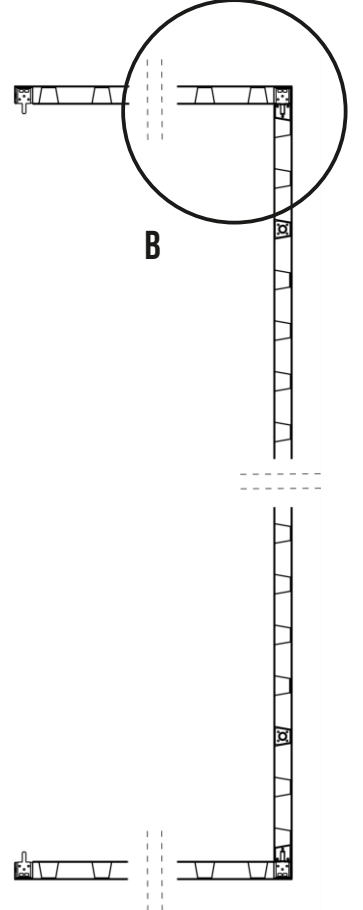
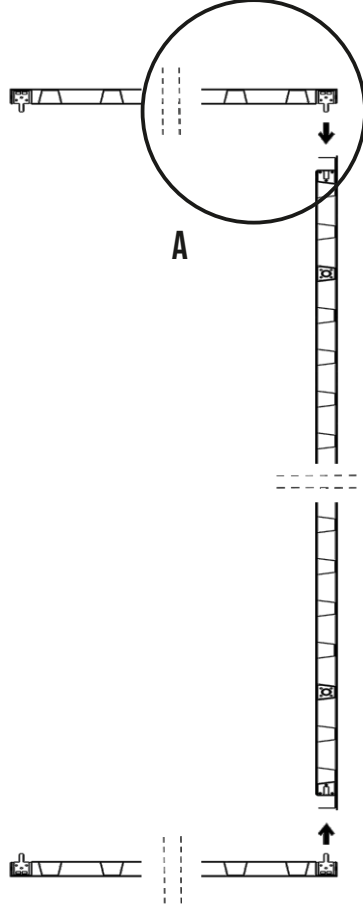
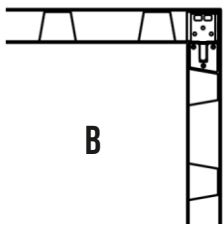
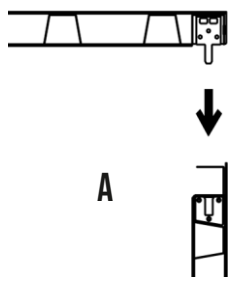

3.2.

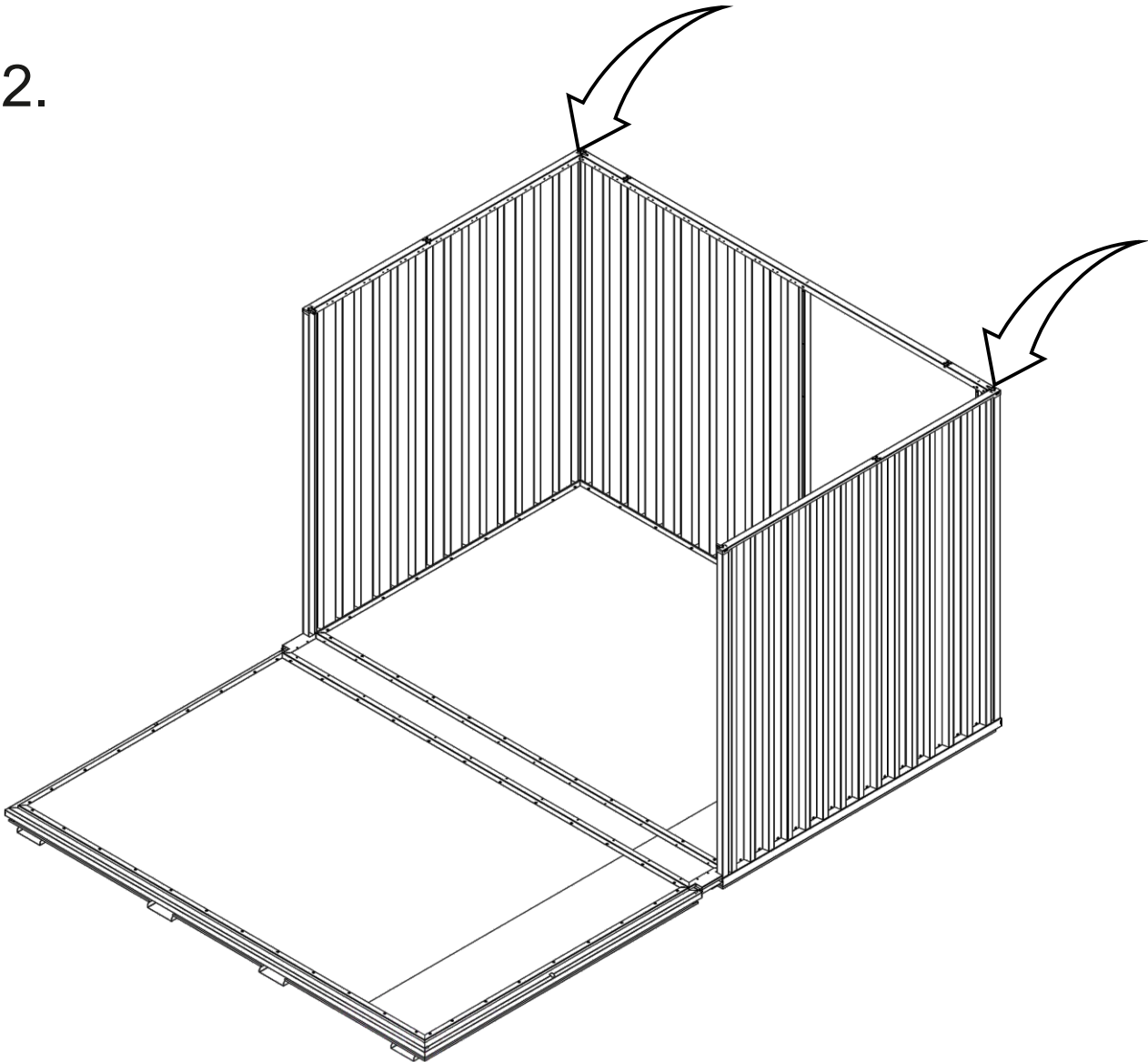

3.3.

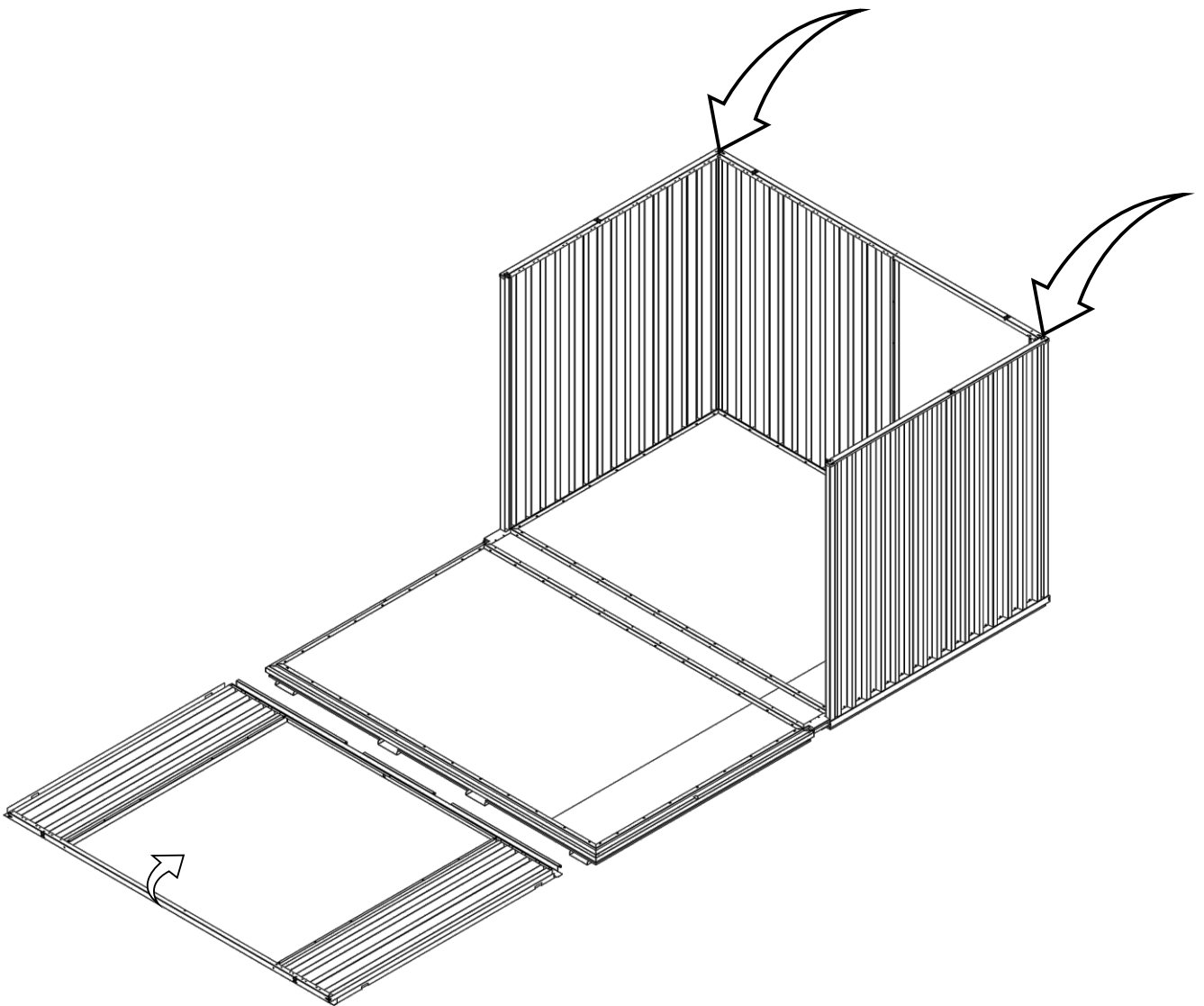
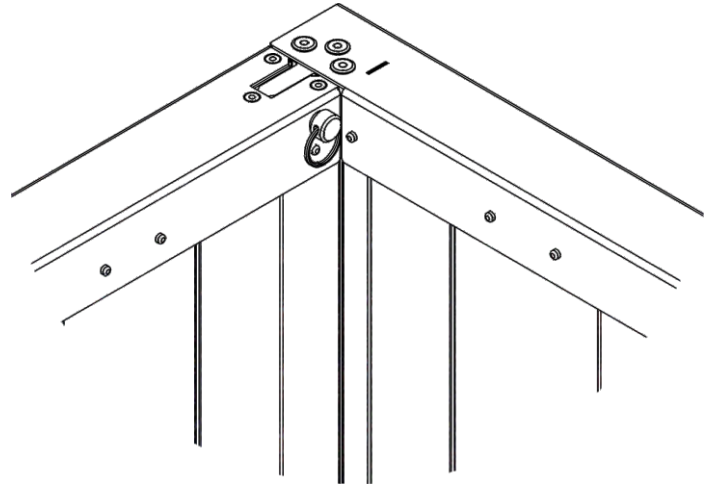
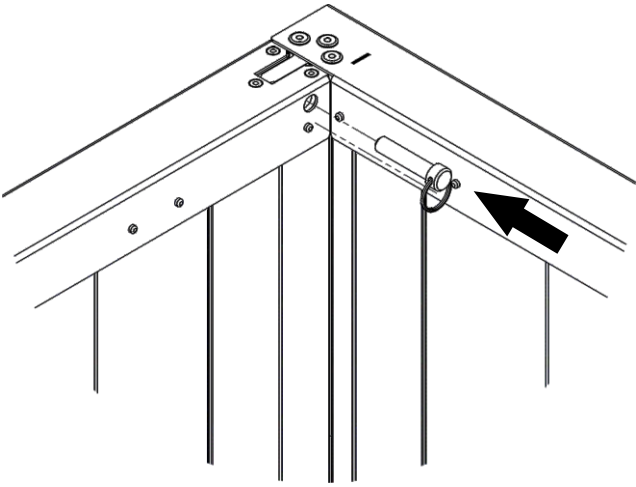

4.1.

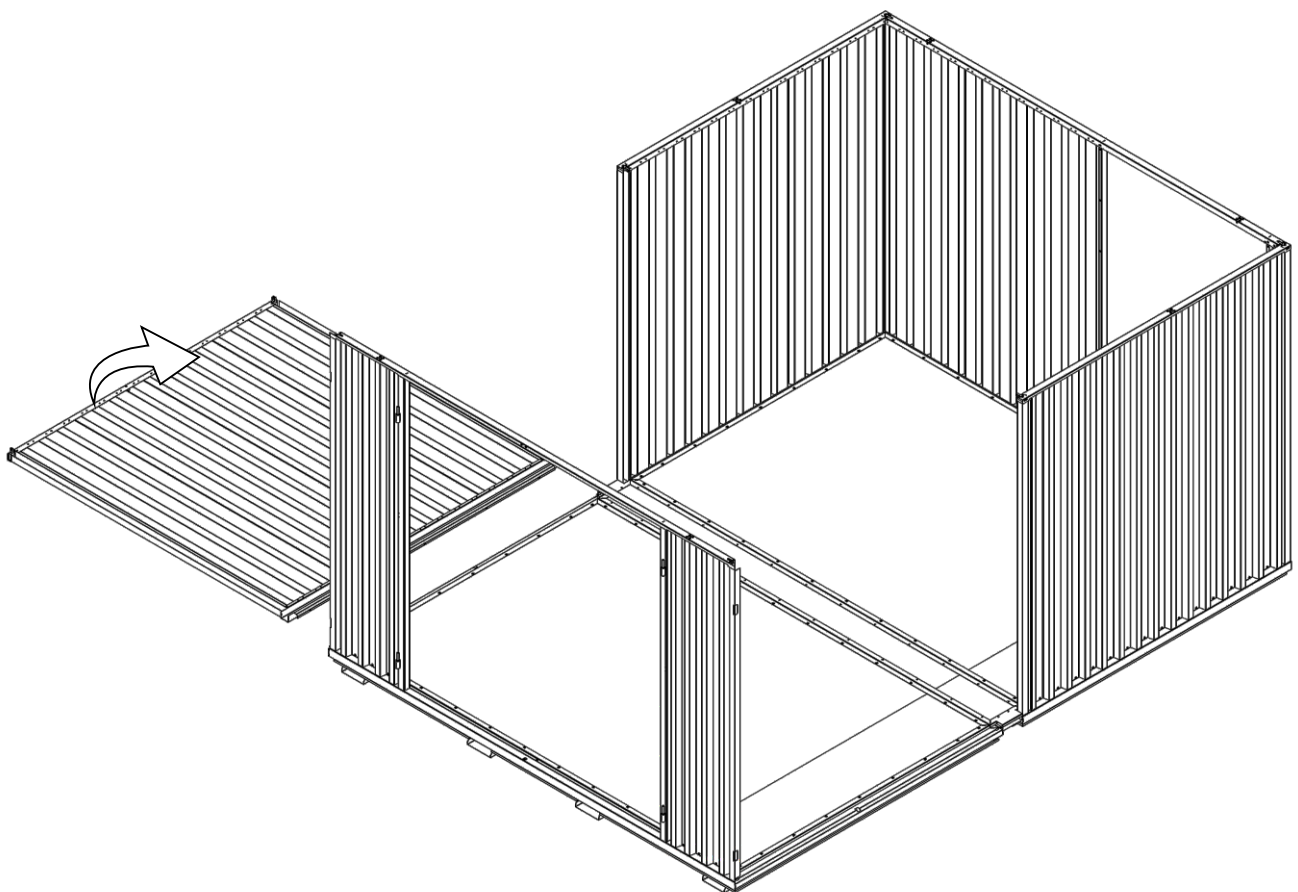
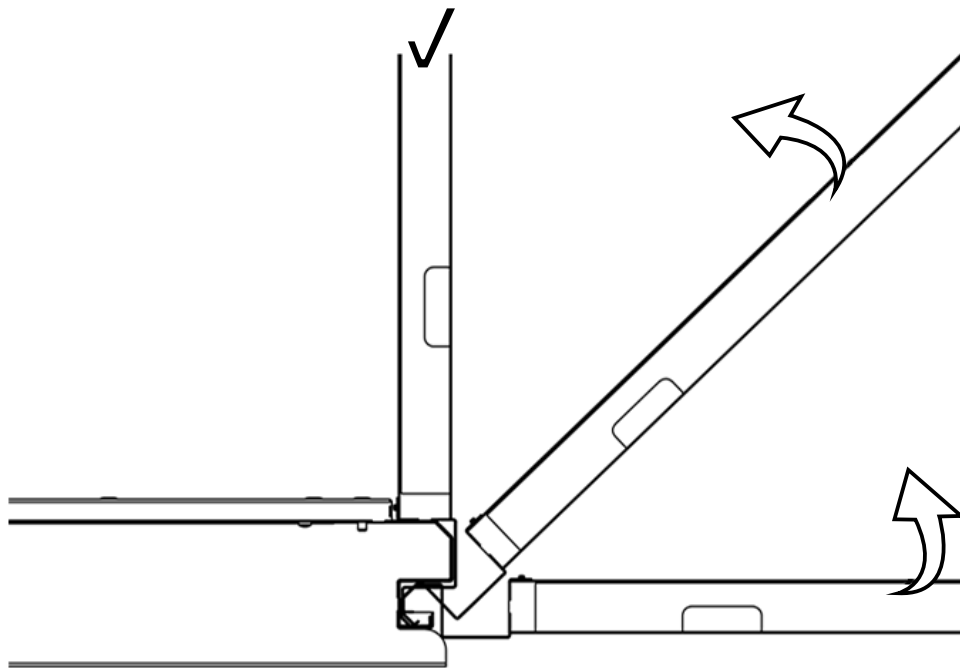

5.1.

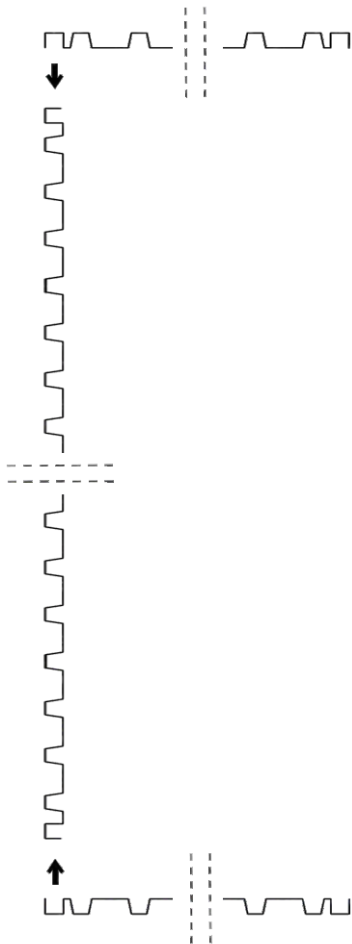
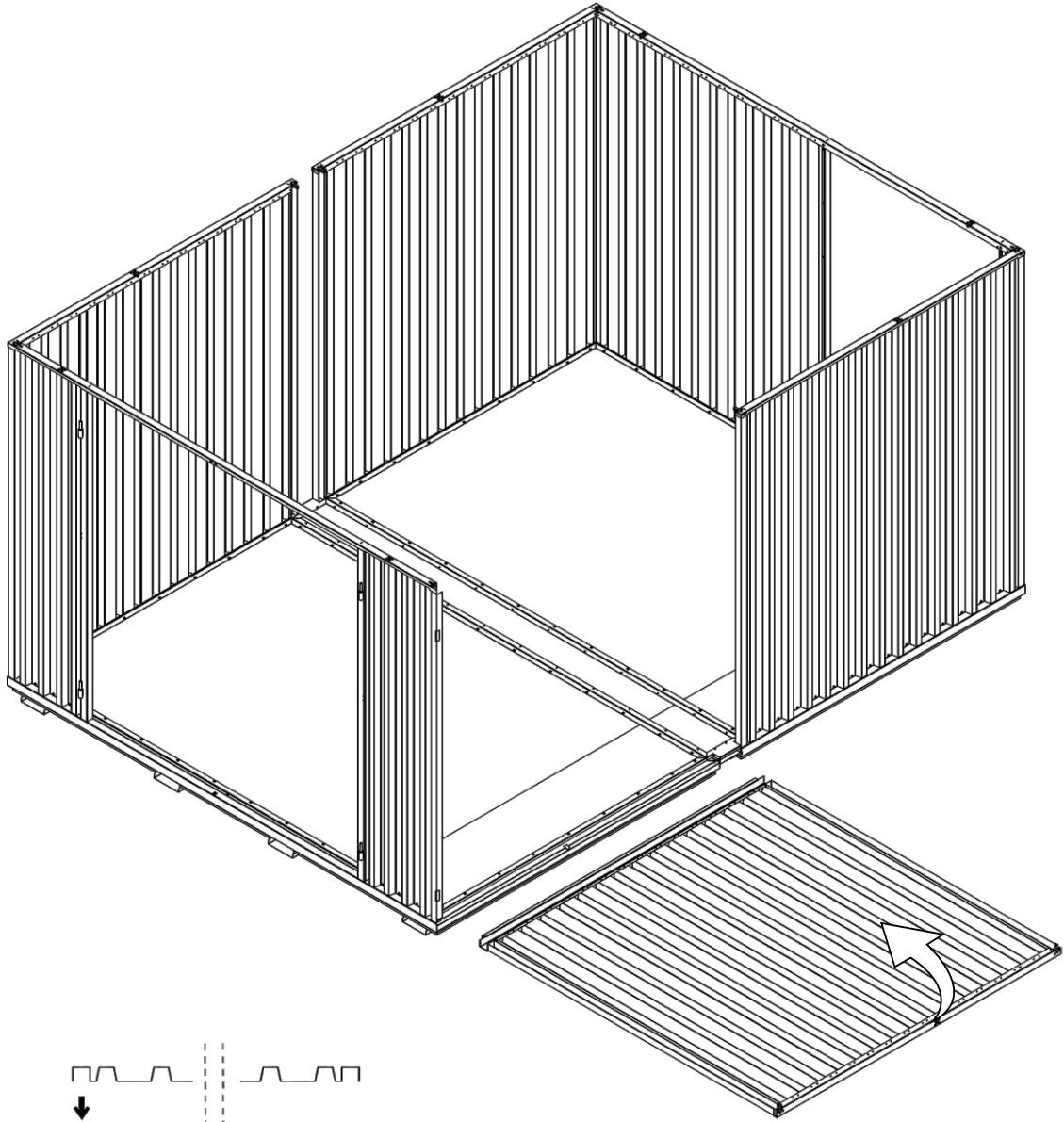

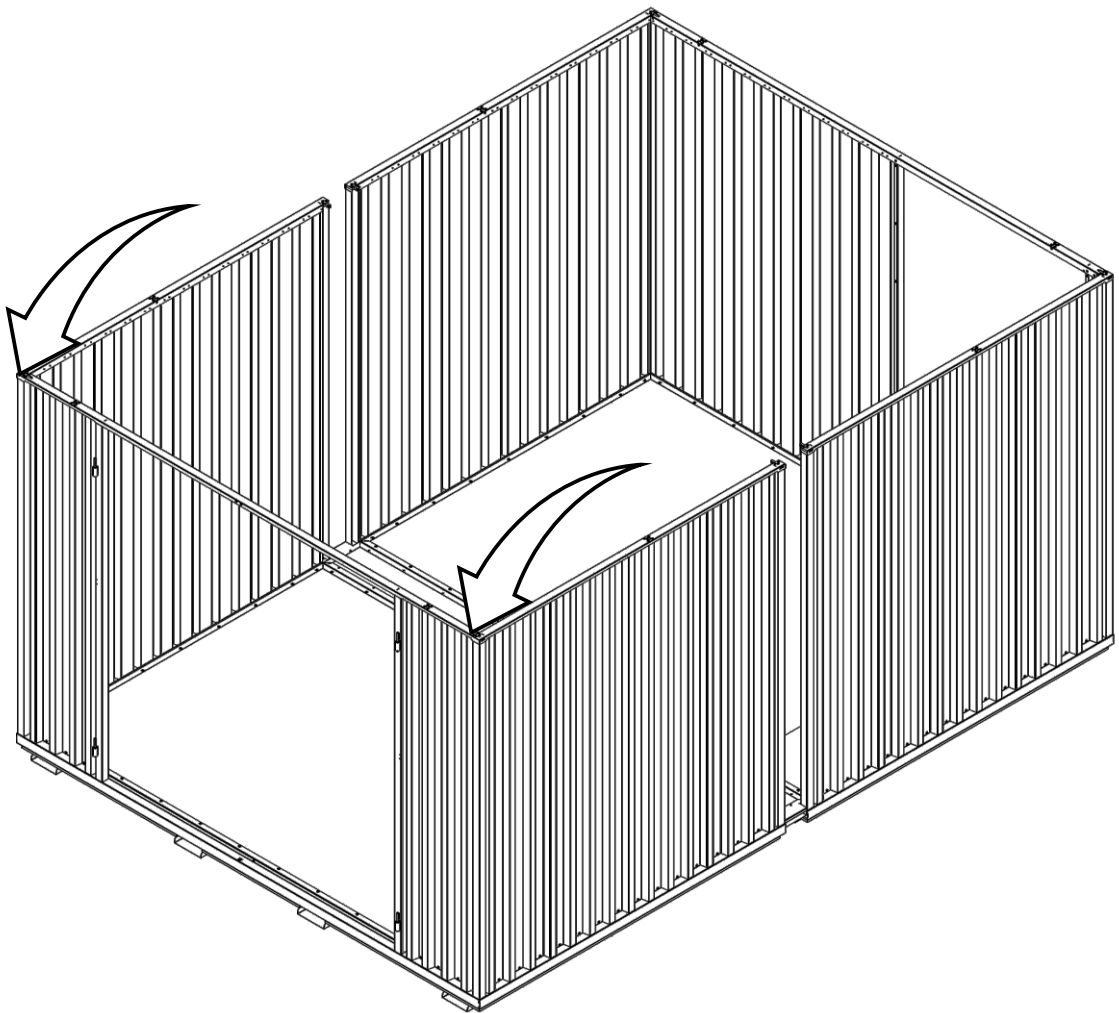
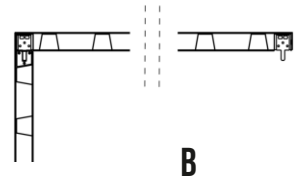
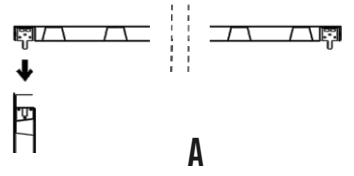
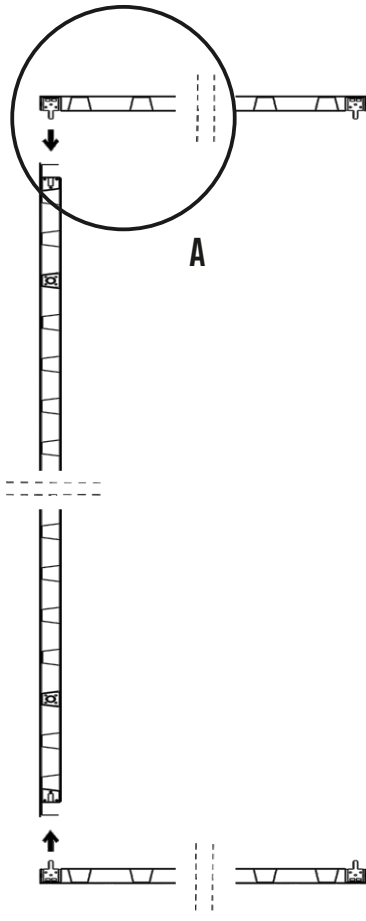
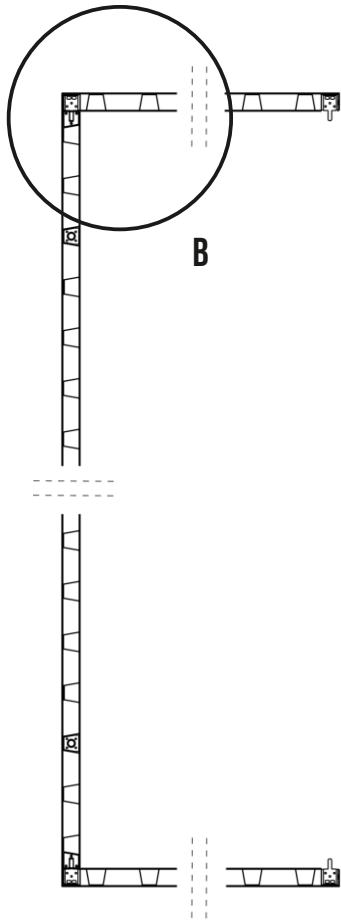

5.2.

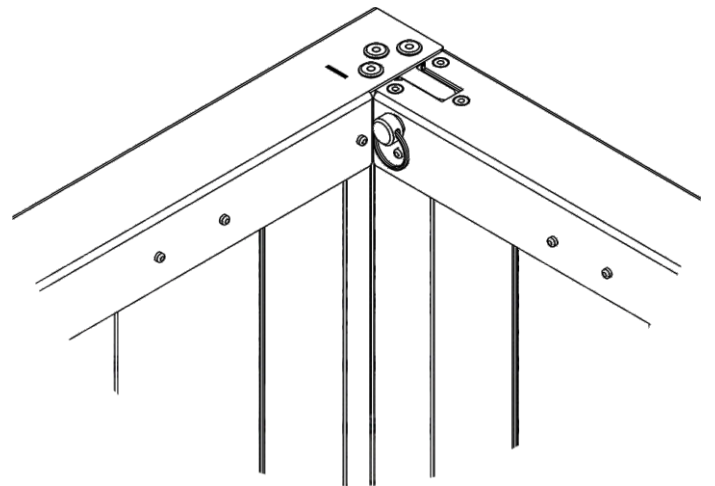
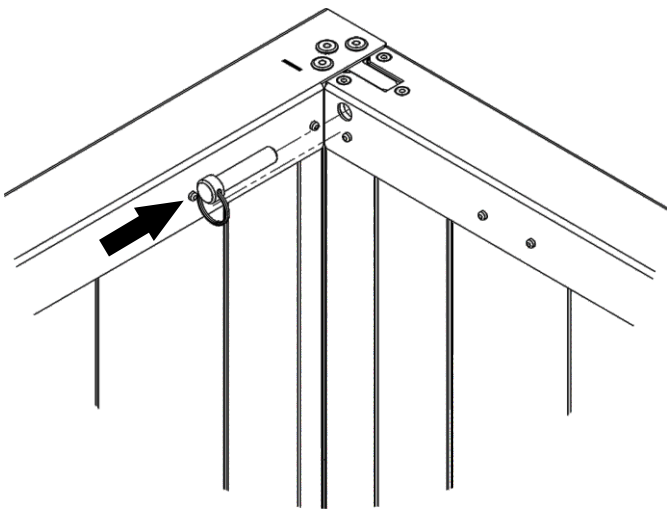
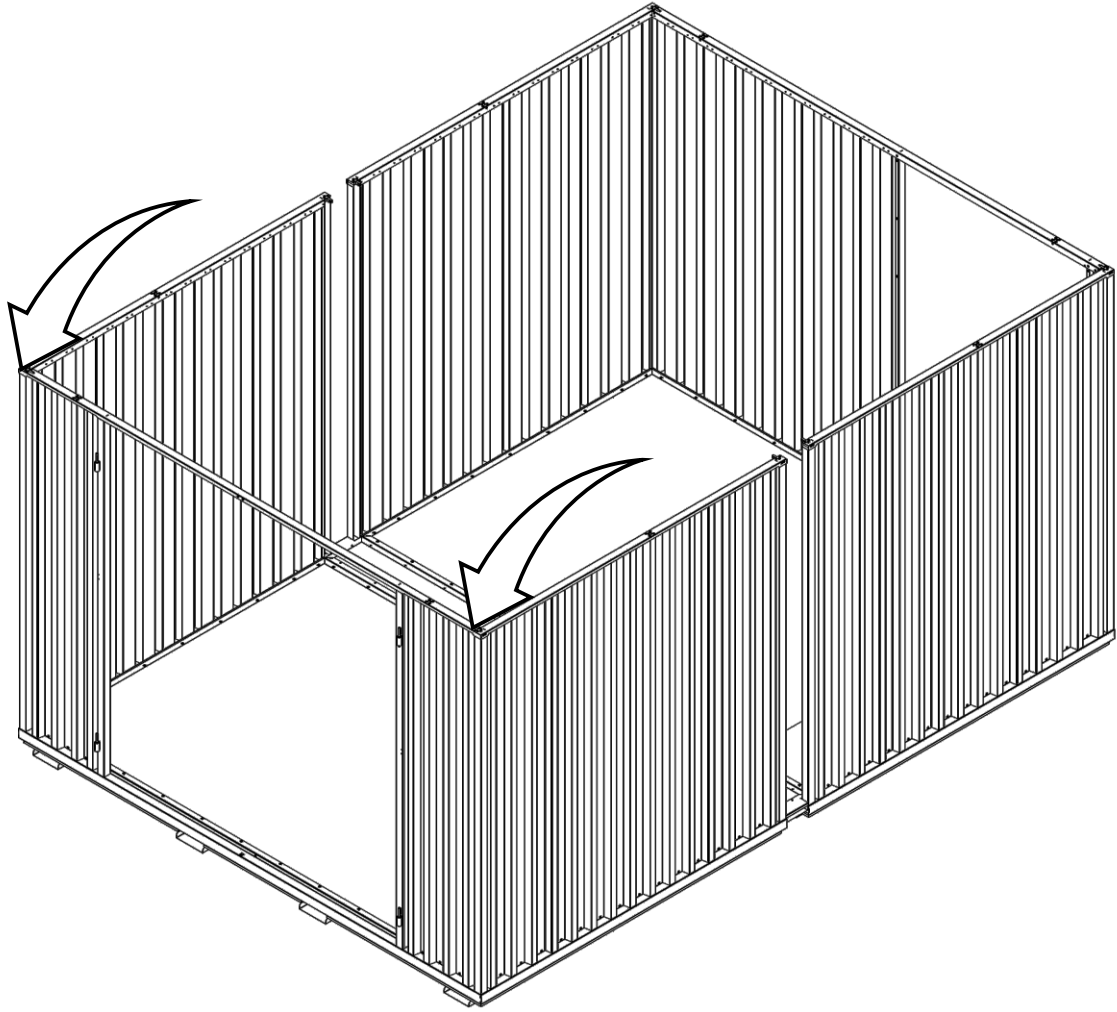

7.1.

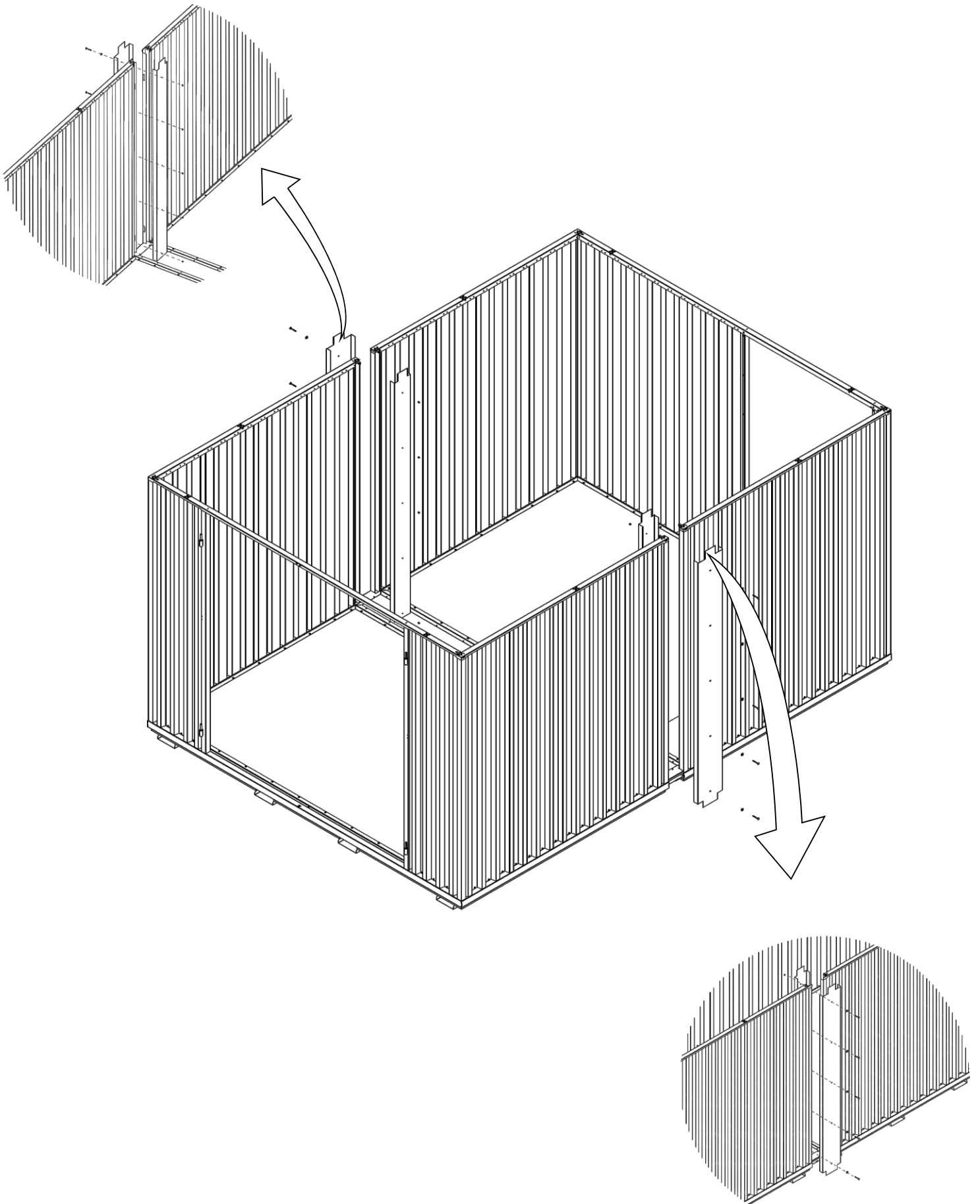



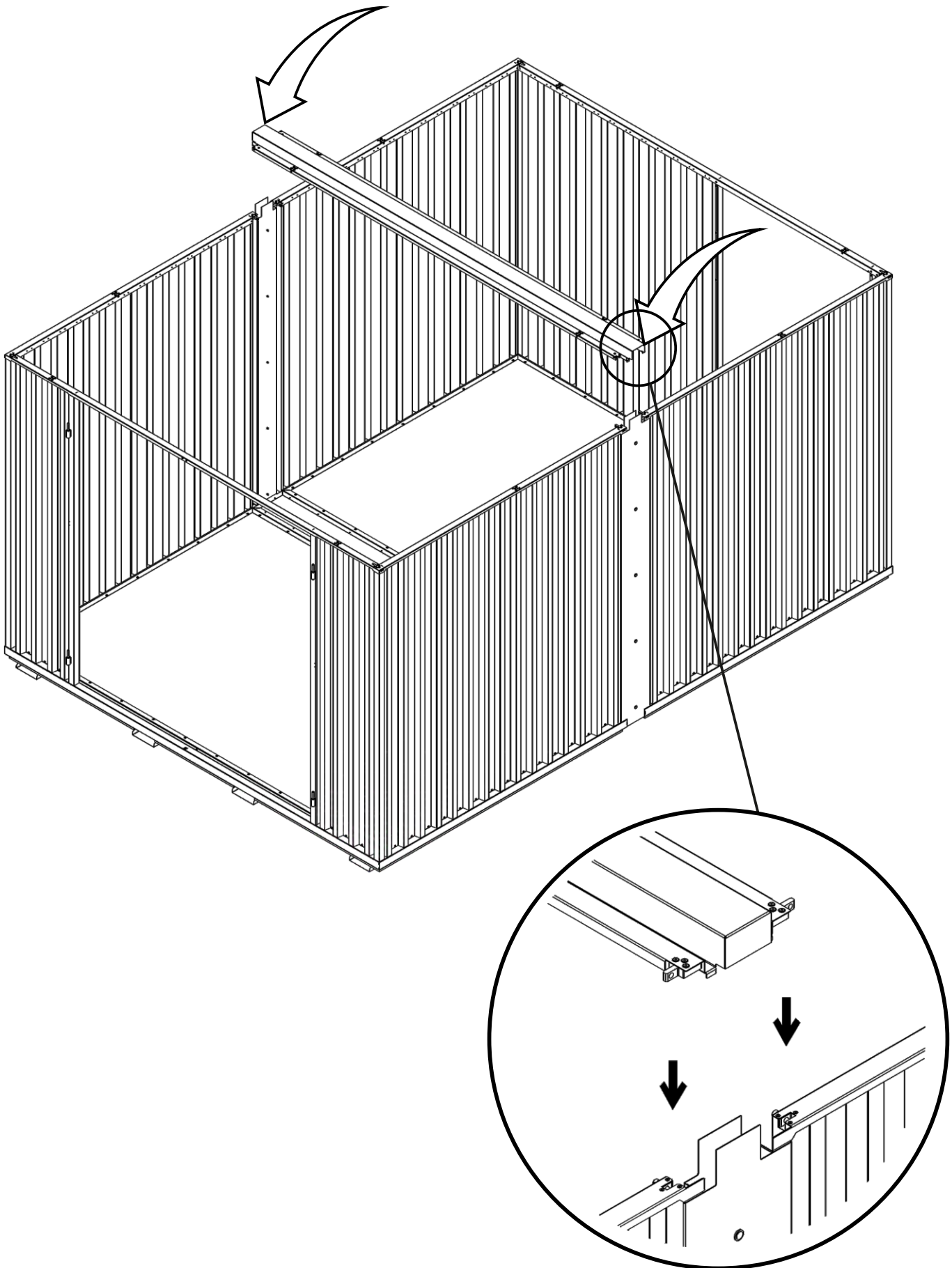



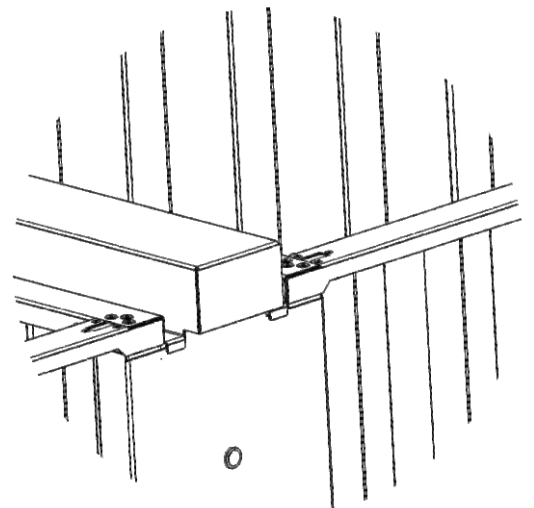
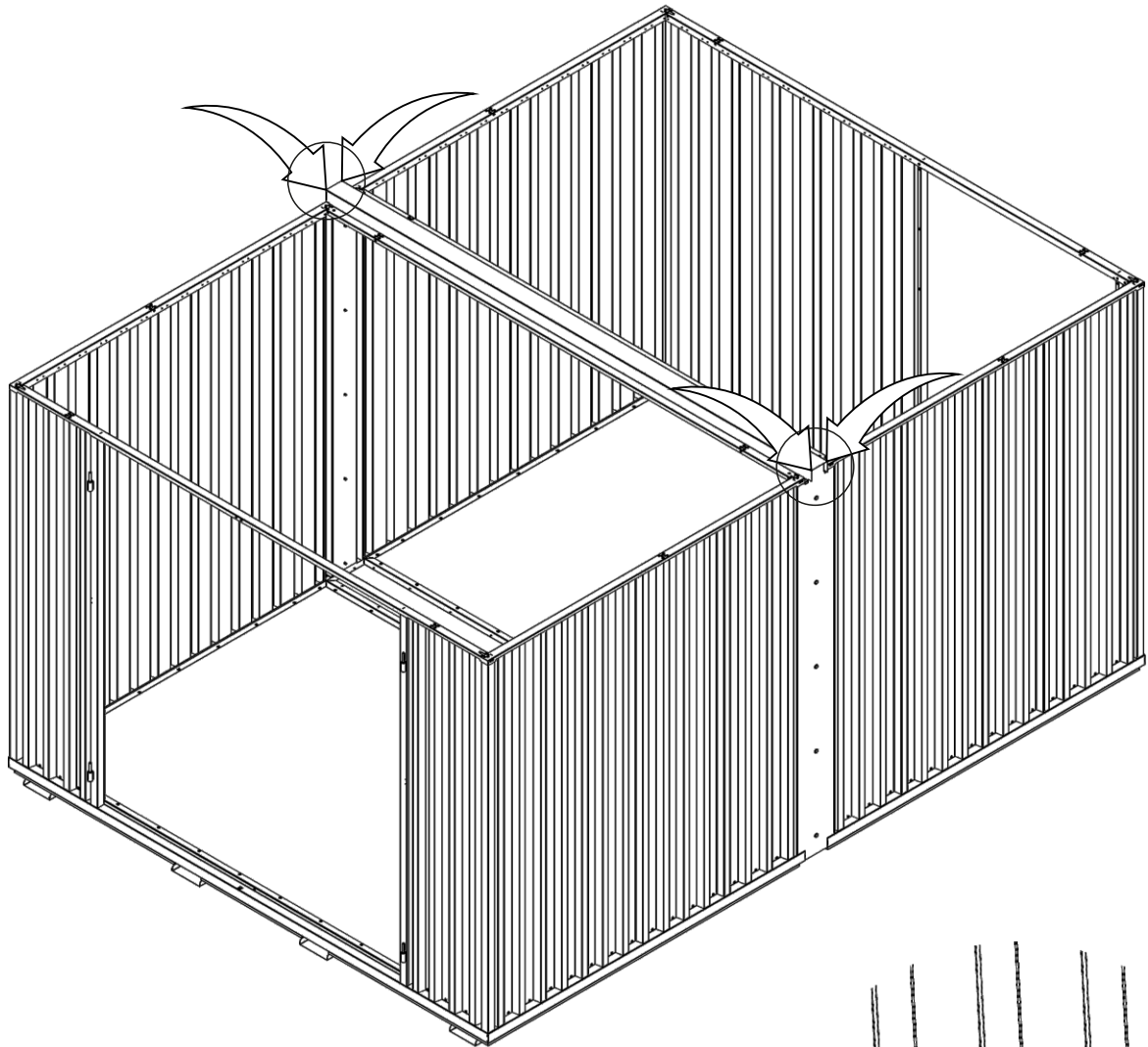
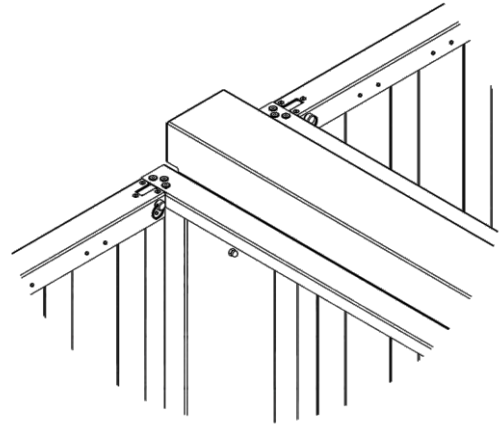
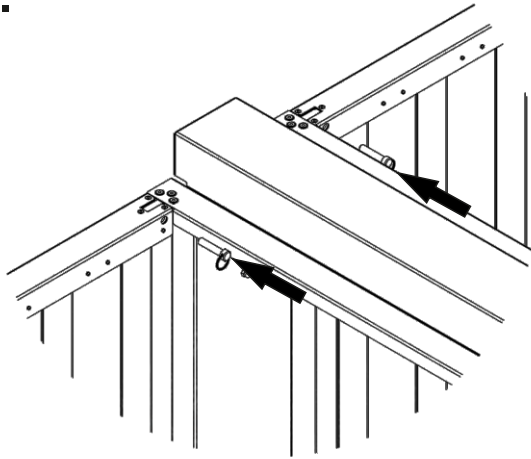

8.1.



8.2.



9.1.

 Mass ...Kg.	 Total ... Kg.	 1640 MM	Model Code Production Tracking Code   		
--	--	--	---	---	---

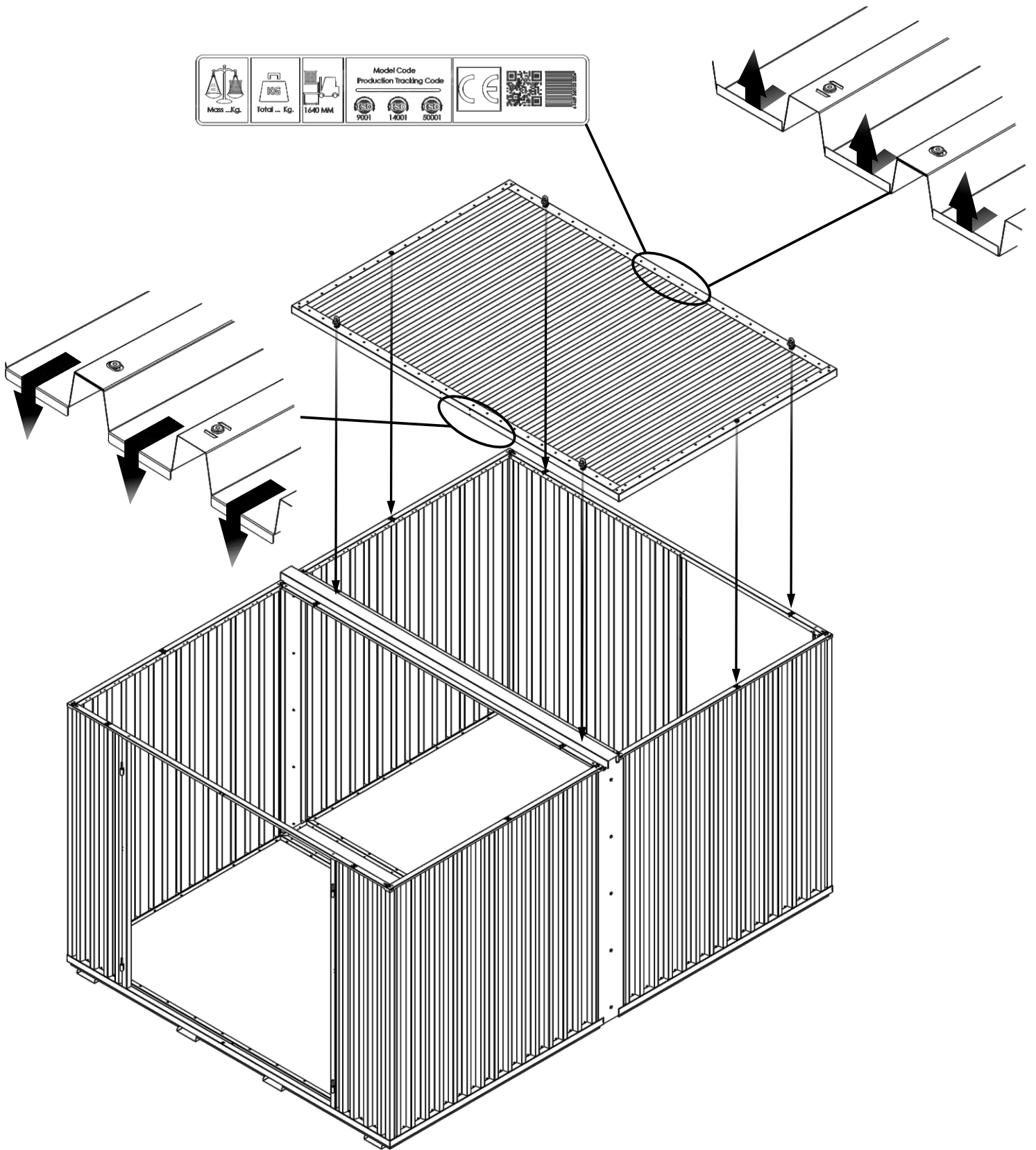

9.2.

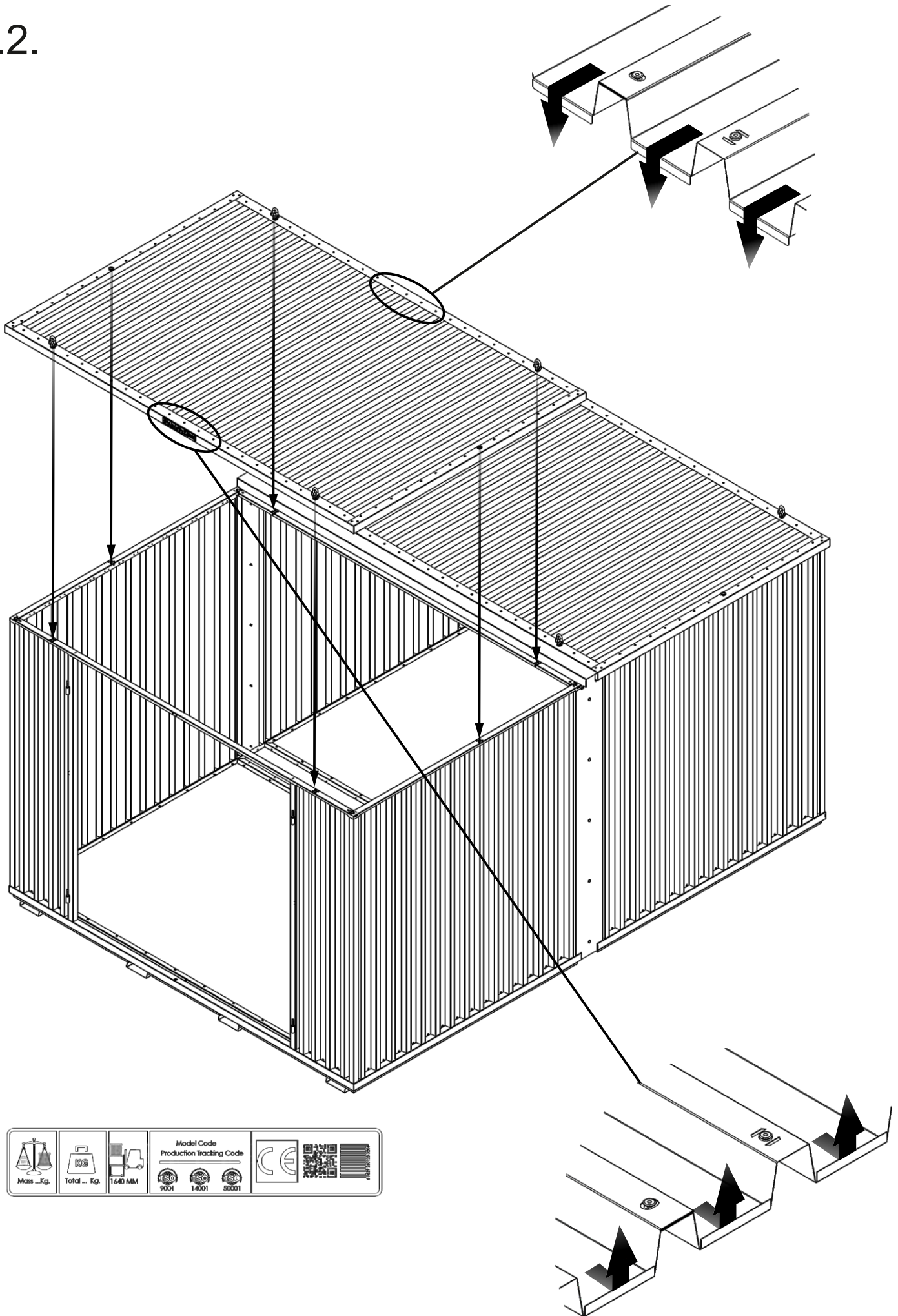

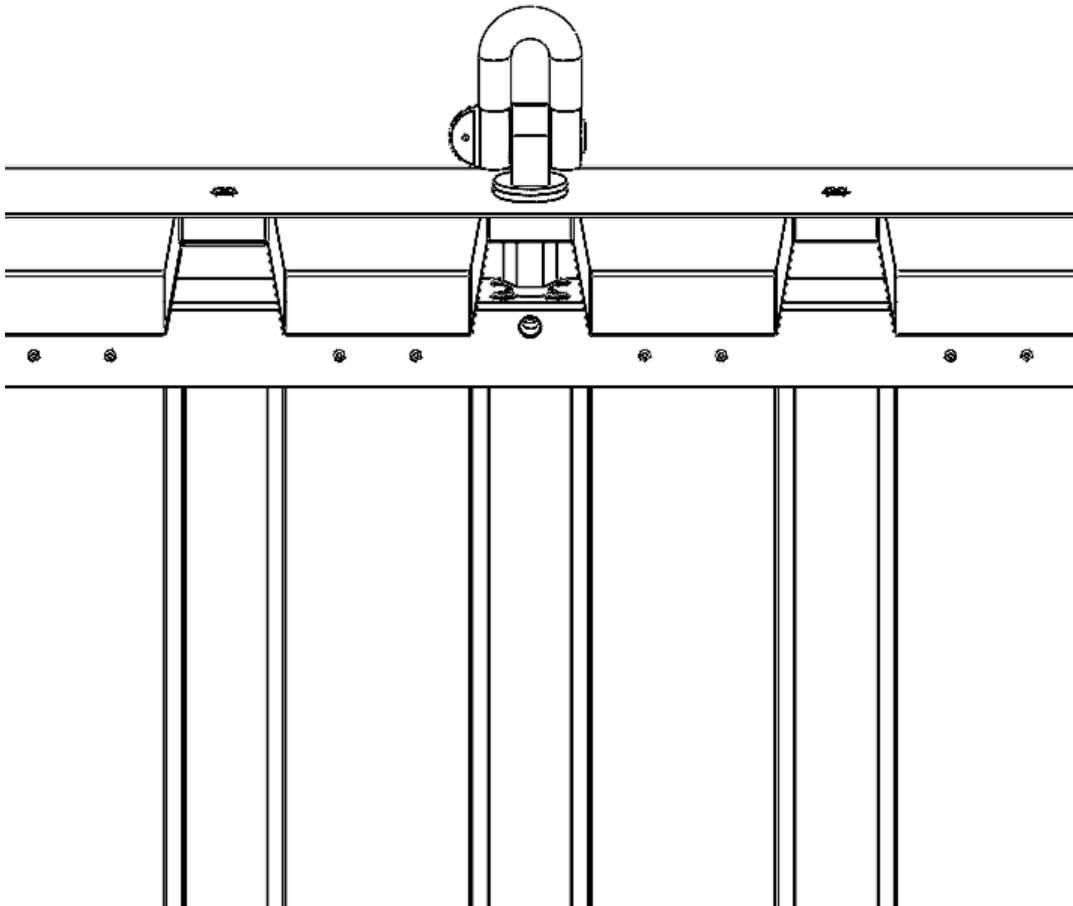
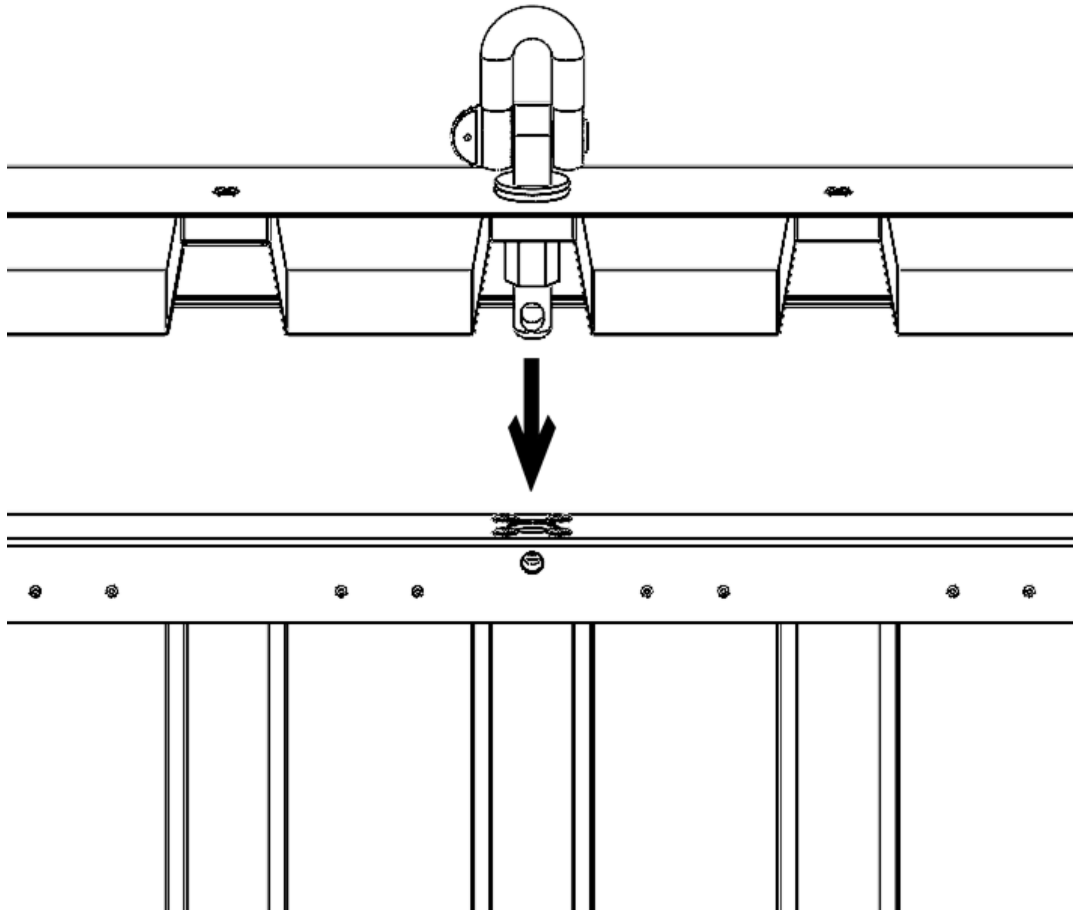

9.4.

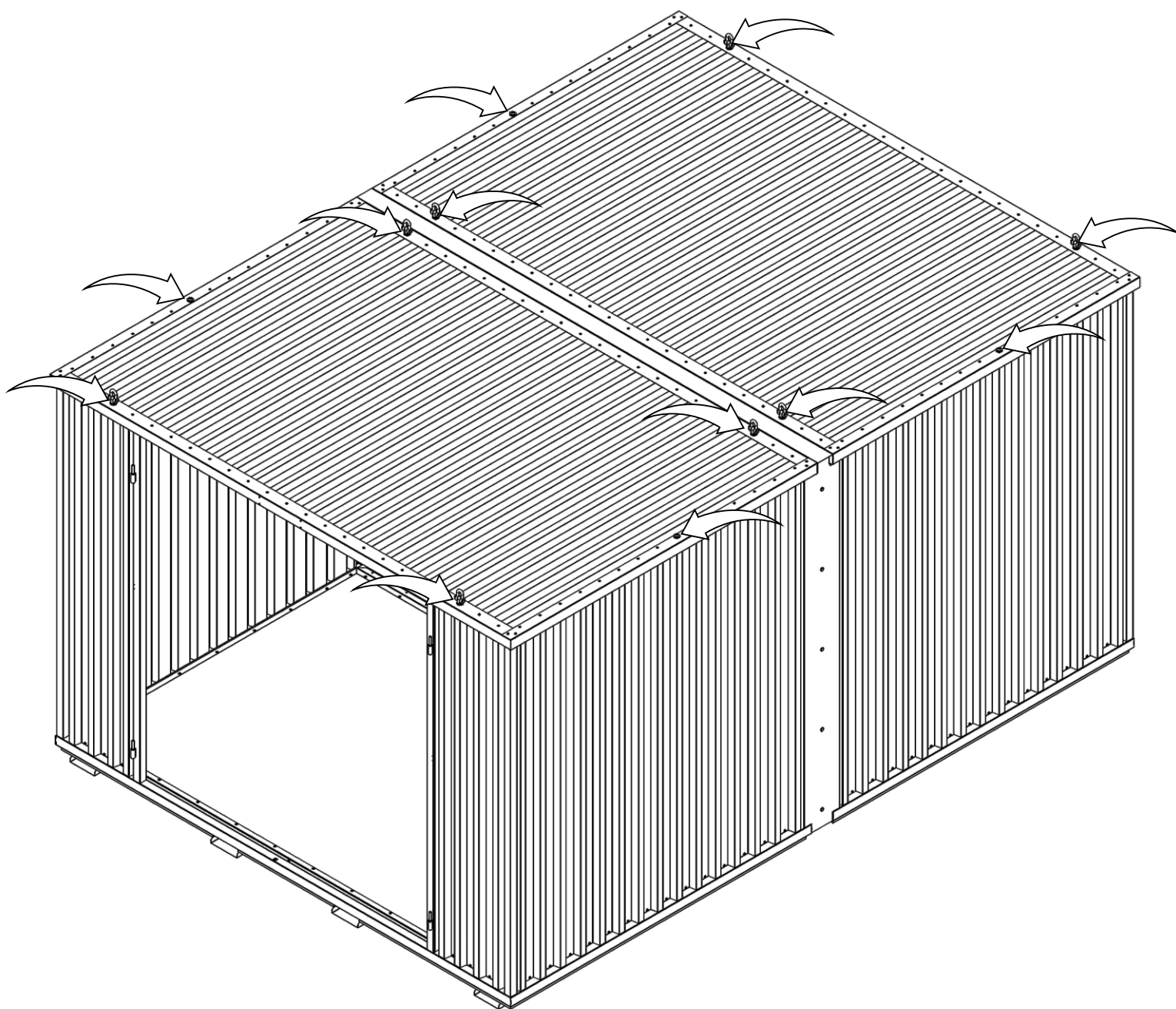

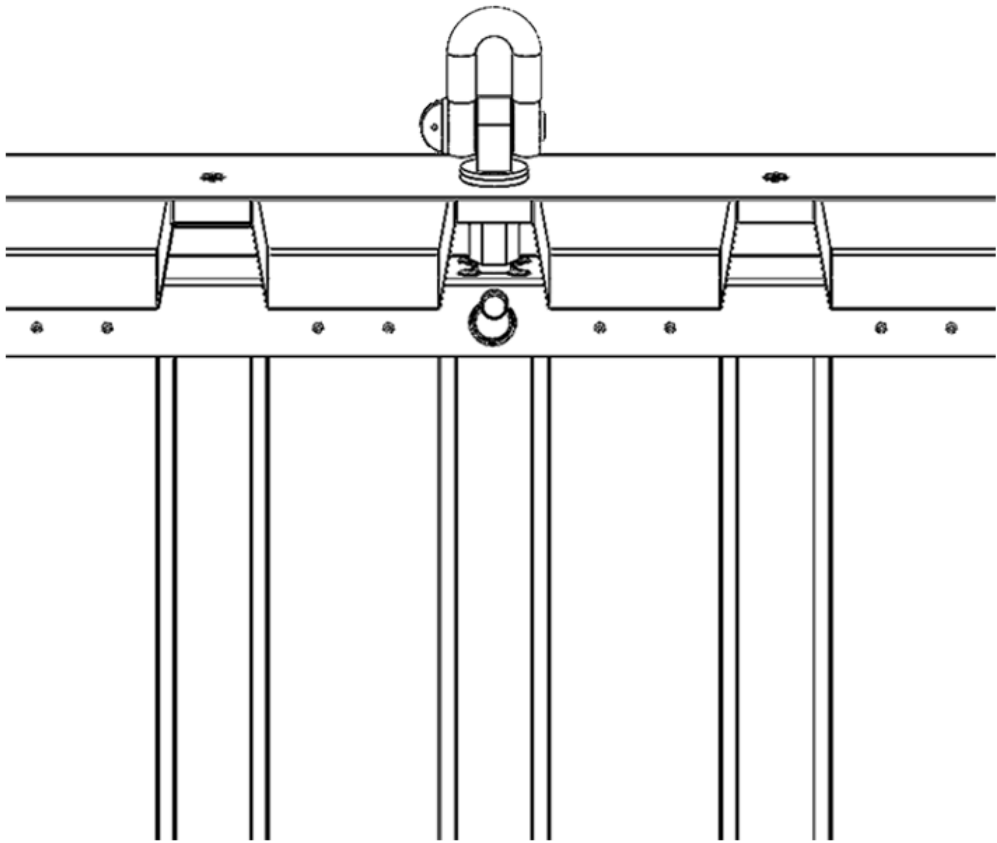
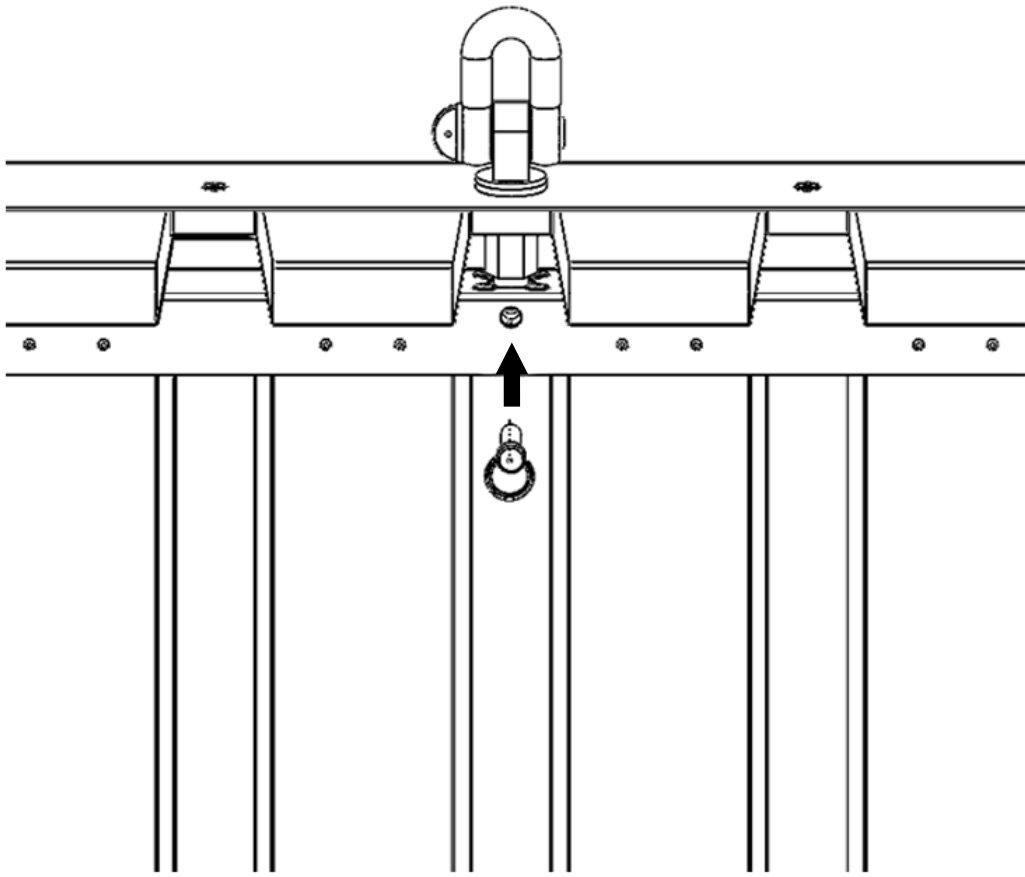

10.1.

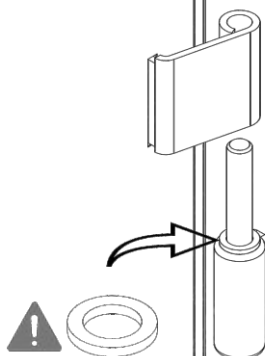
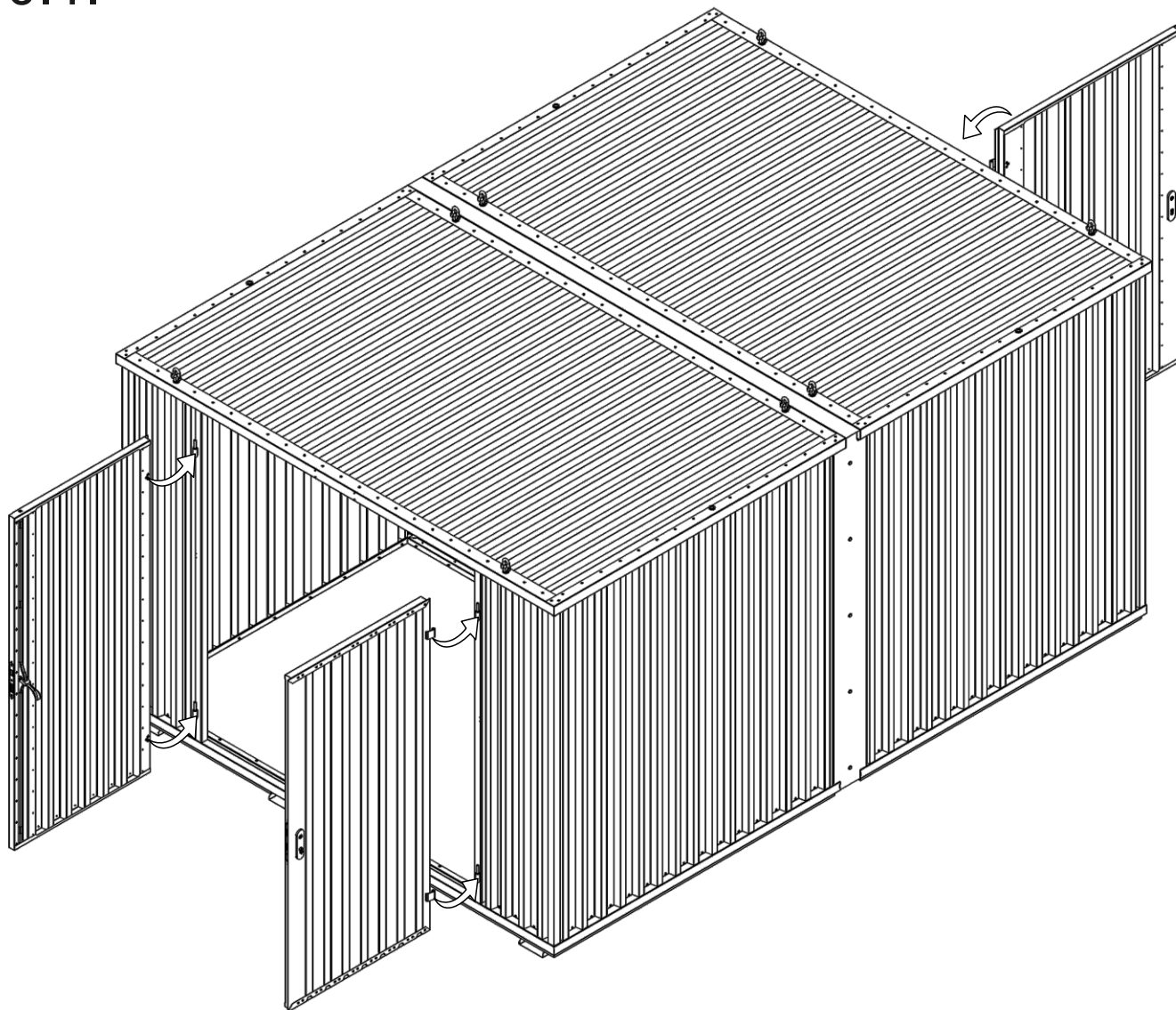

10.2.

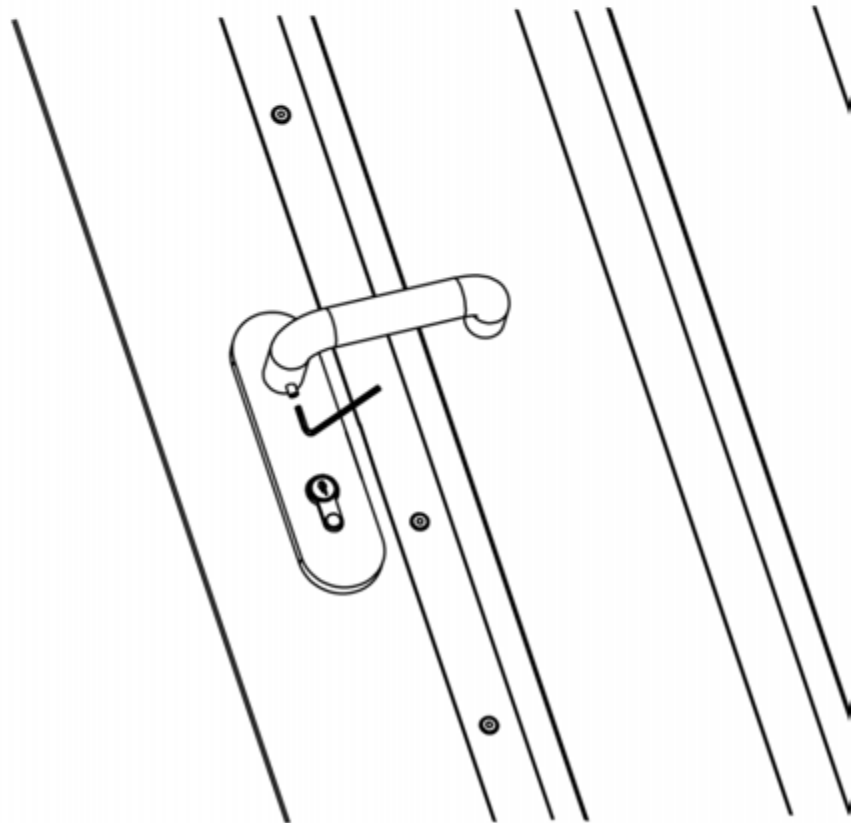
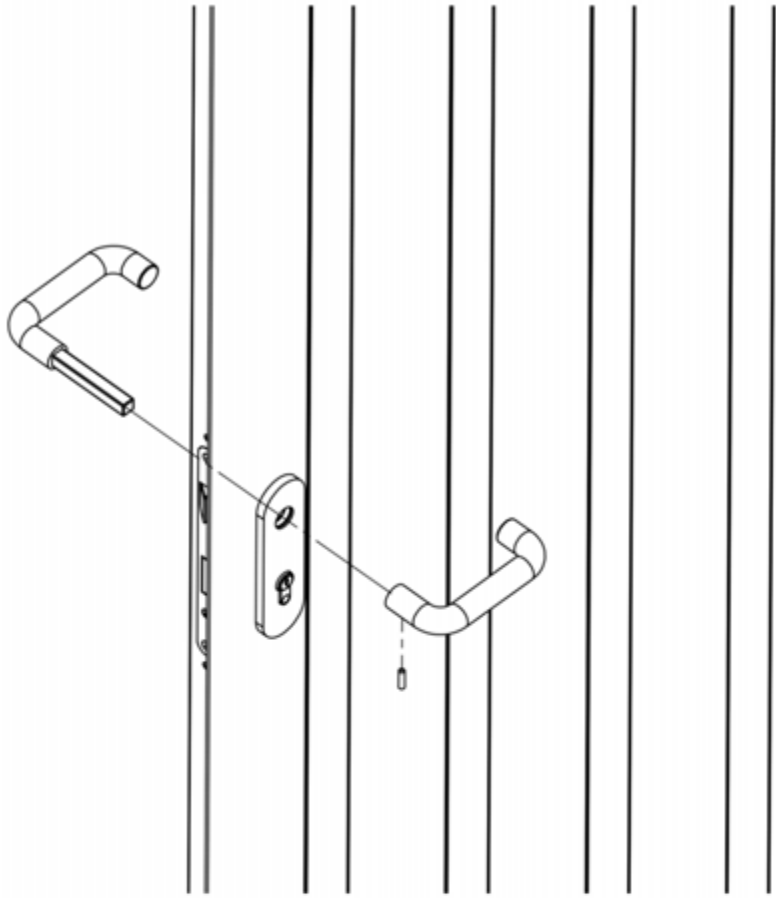

11.1.

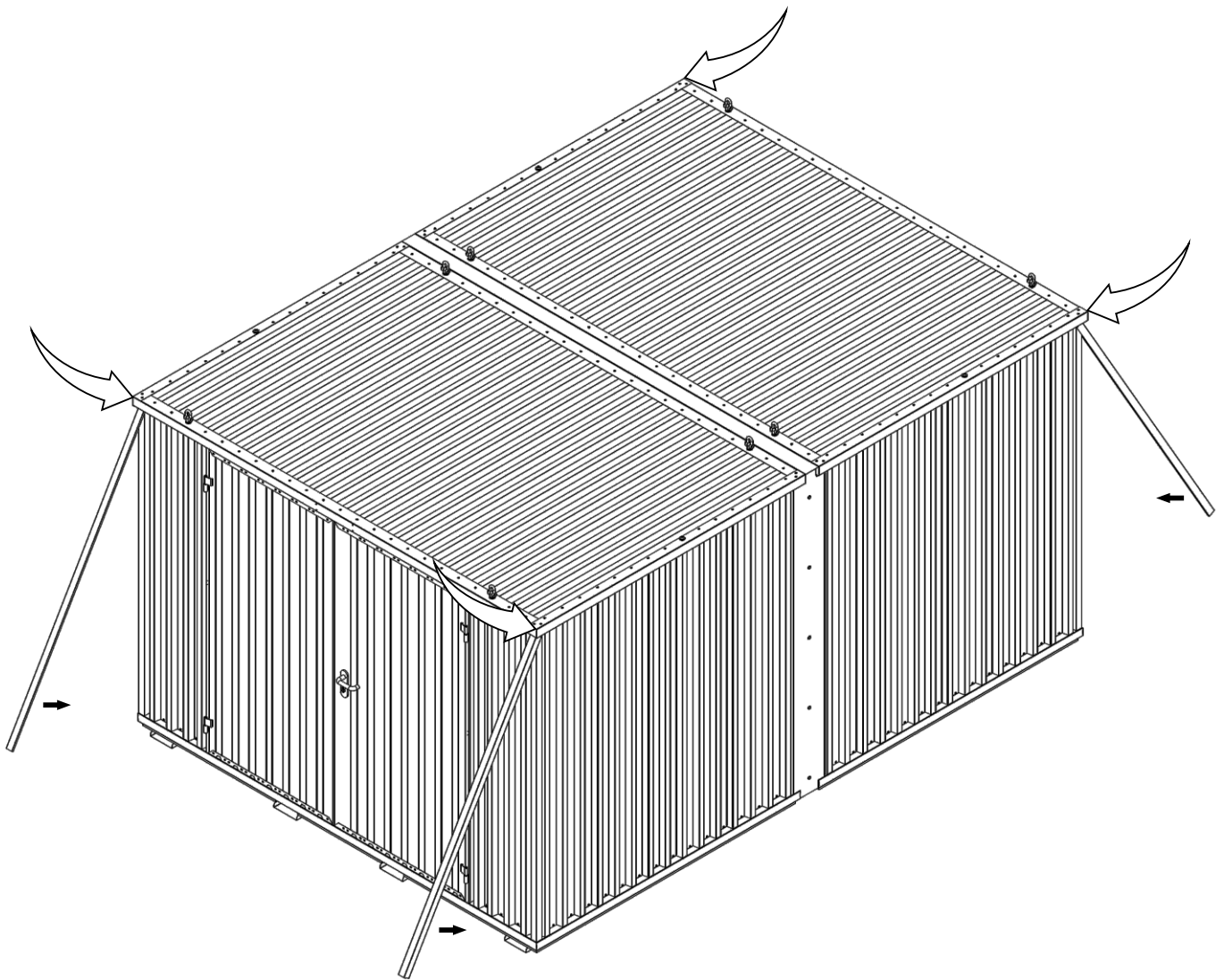

12.1.

