

PRODUCT CODE:505.110.430.440

prefabase
Quick Build Solutions

Instructions and User Guide

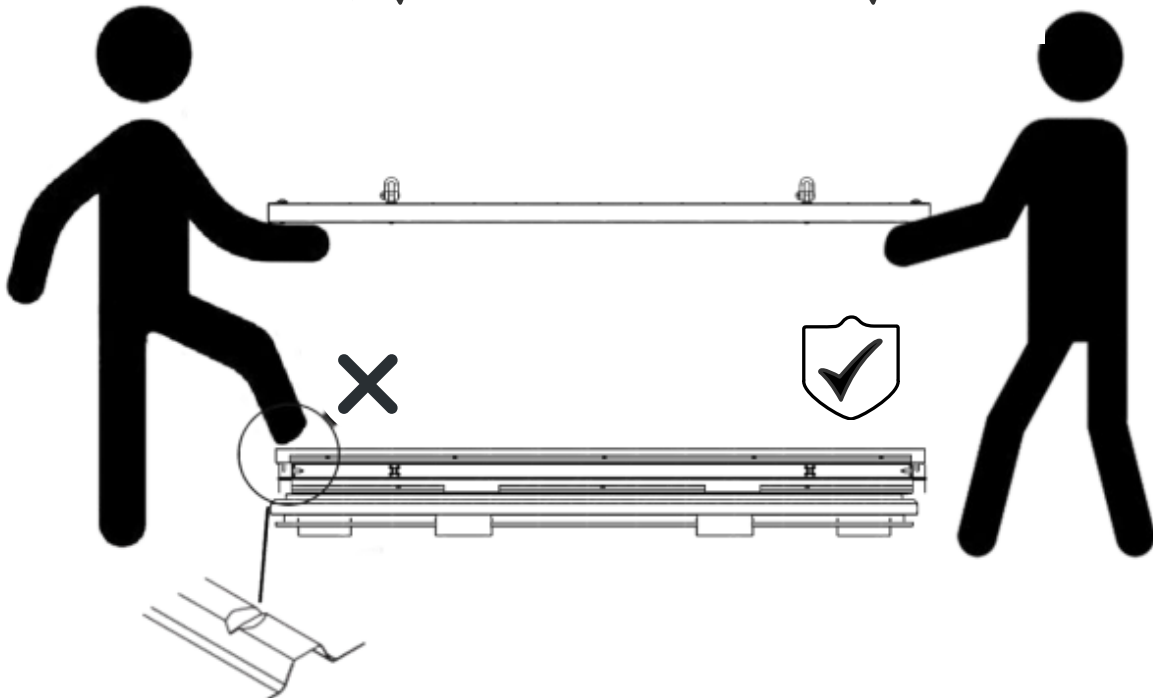

50.0110

2x

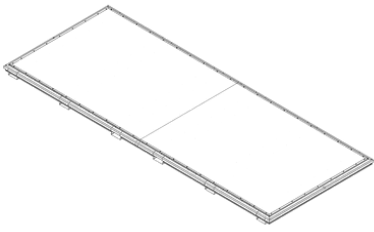

50.0510

2x

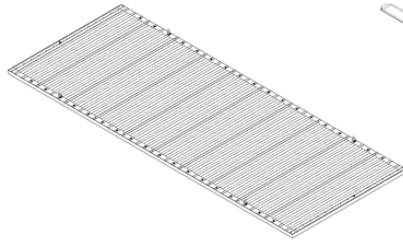

505.0110

1x



505.0510

1x



50.0430

1x

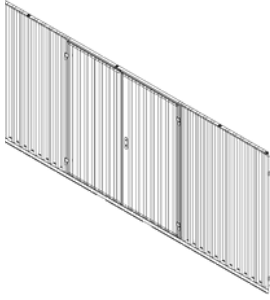

50.0440

1x

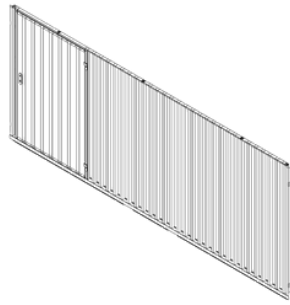

0310

4x

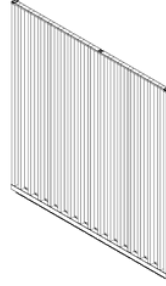

305.20.08

2x



305.20.09

2x



61.101

4x



24x

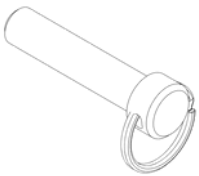

2x

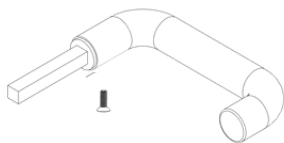

10x



10x

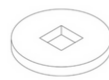

10x



1x



2x



1

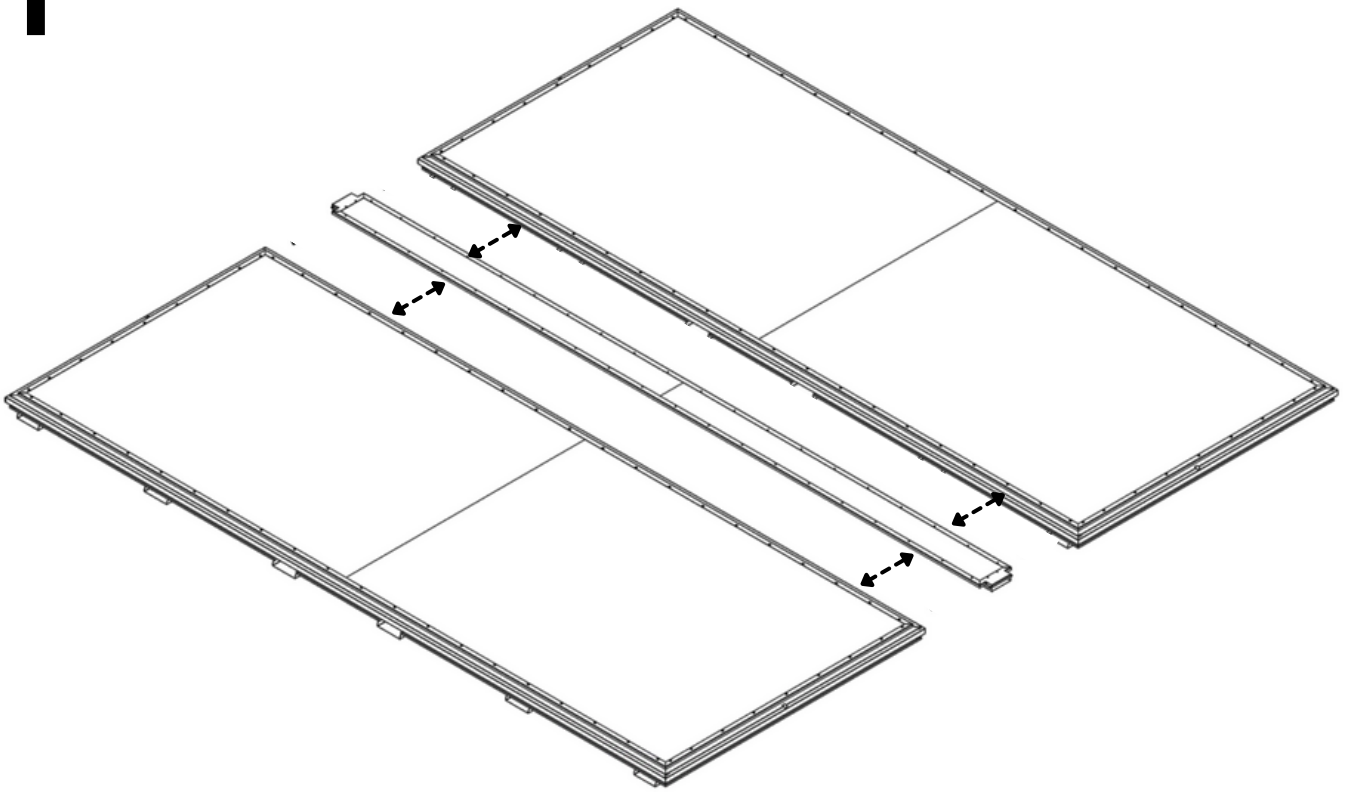

2

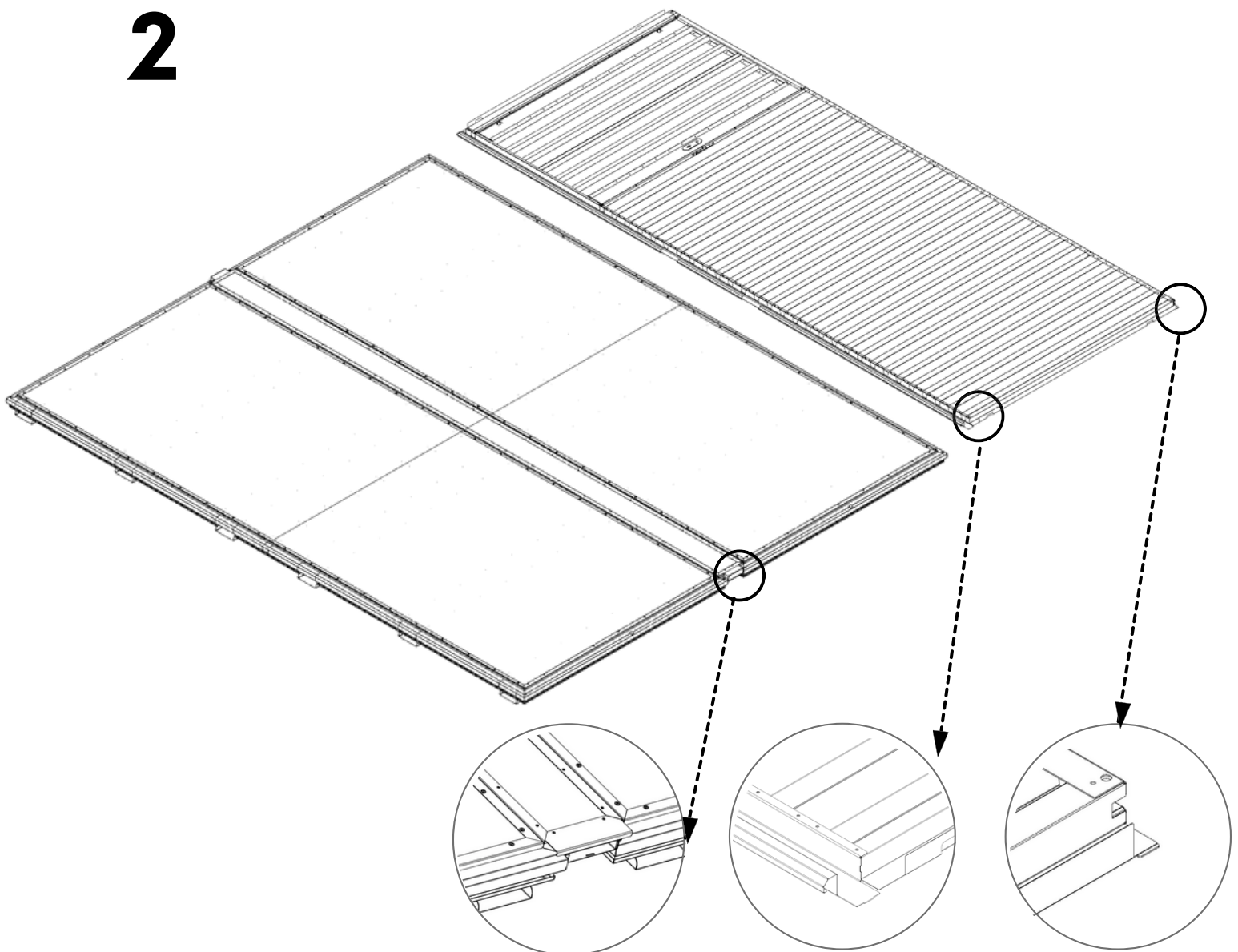

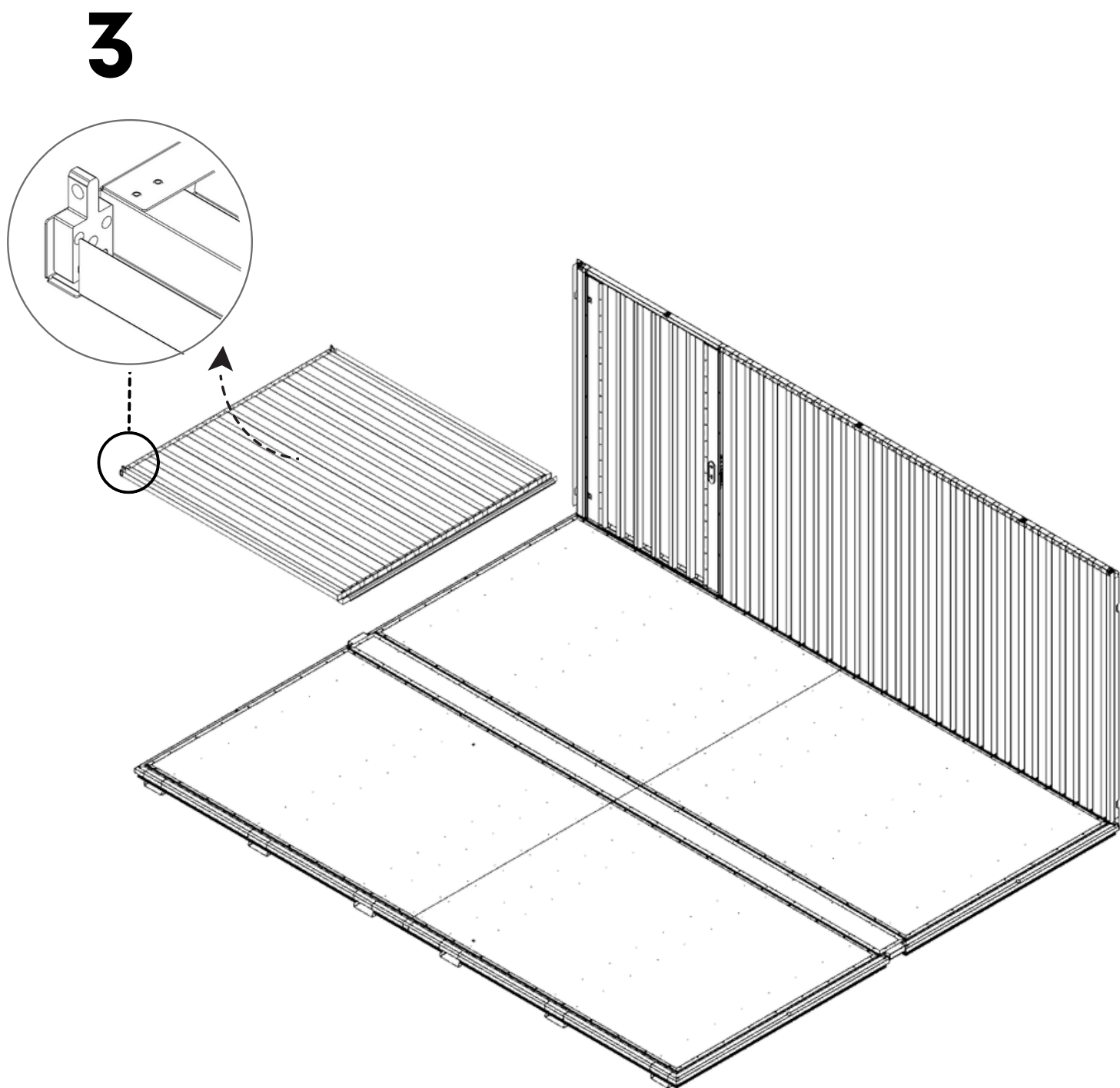
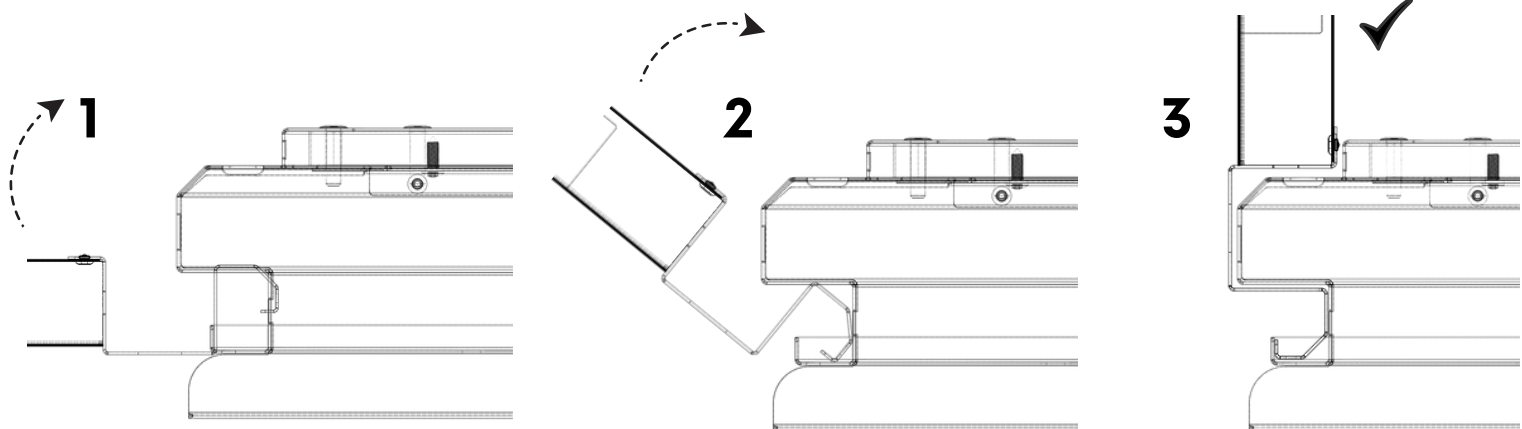

4

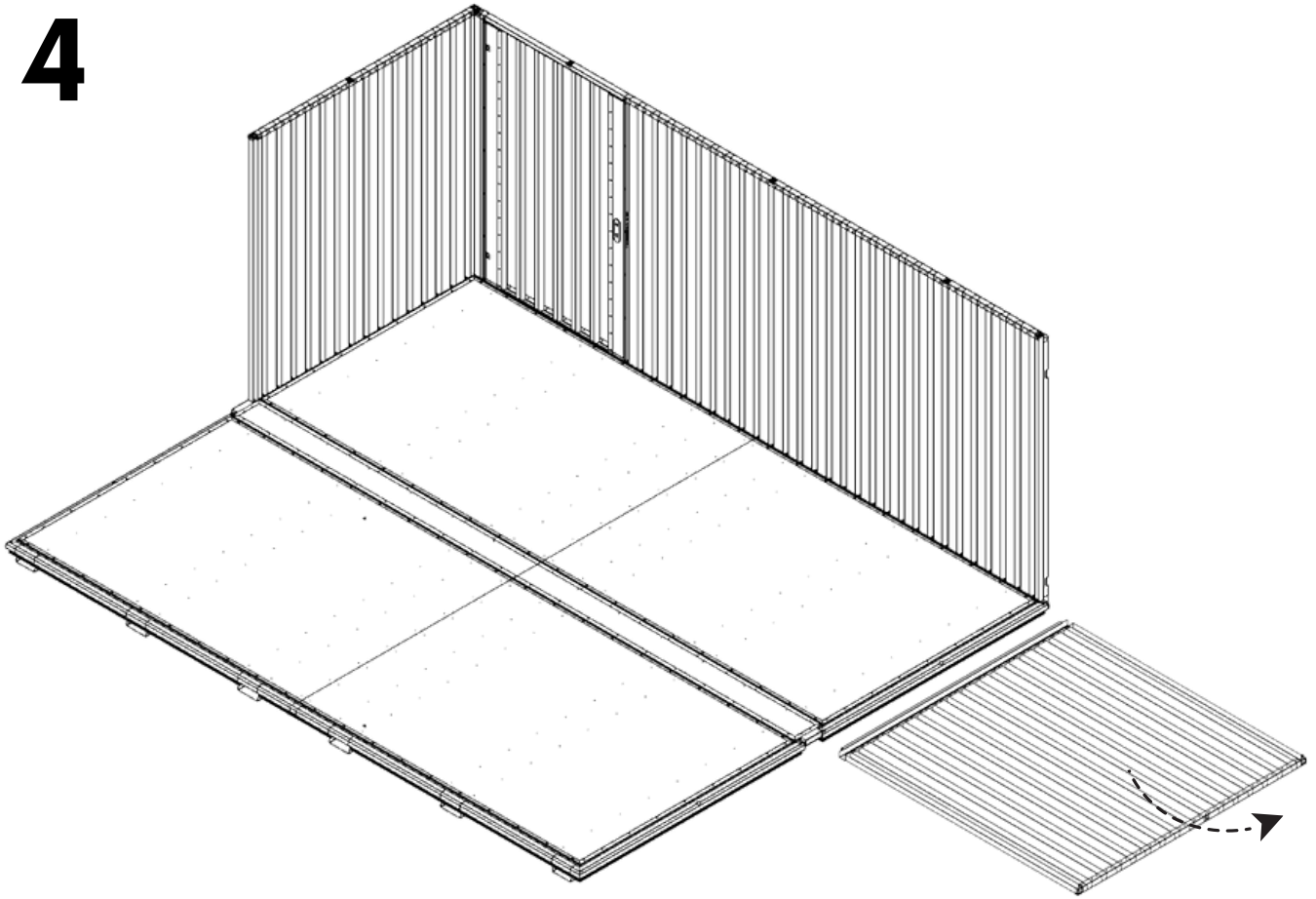

4.1

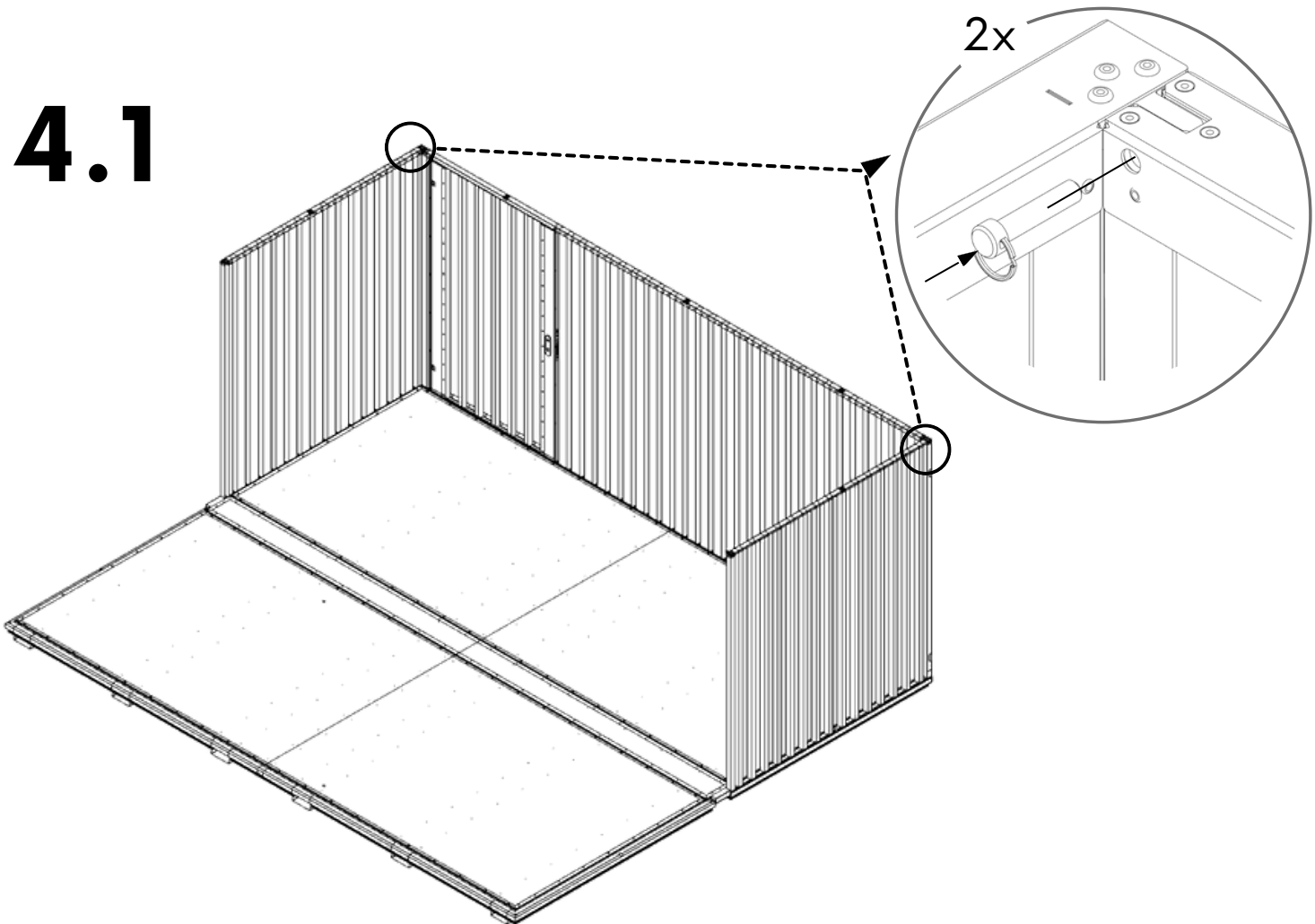

5

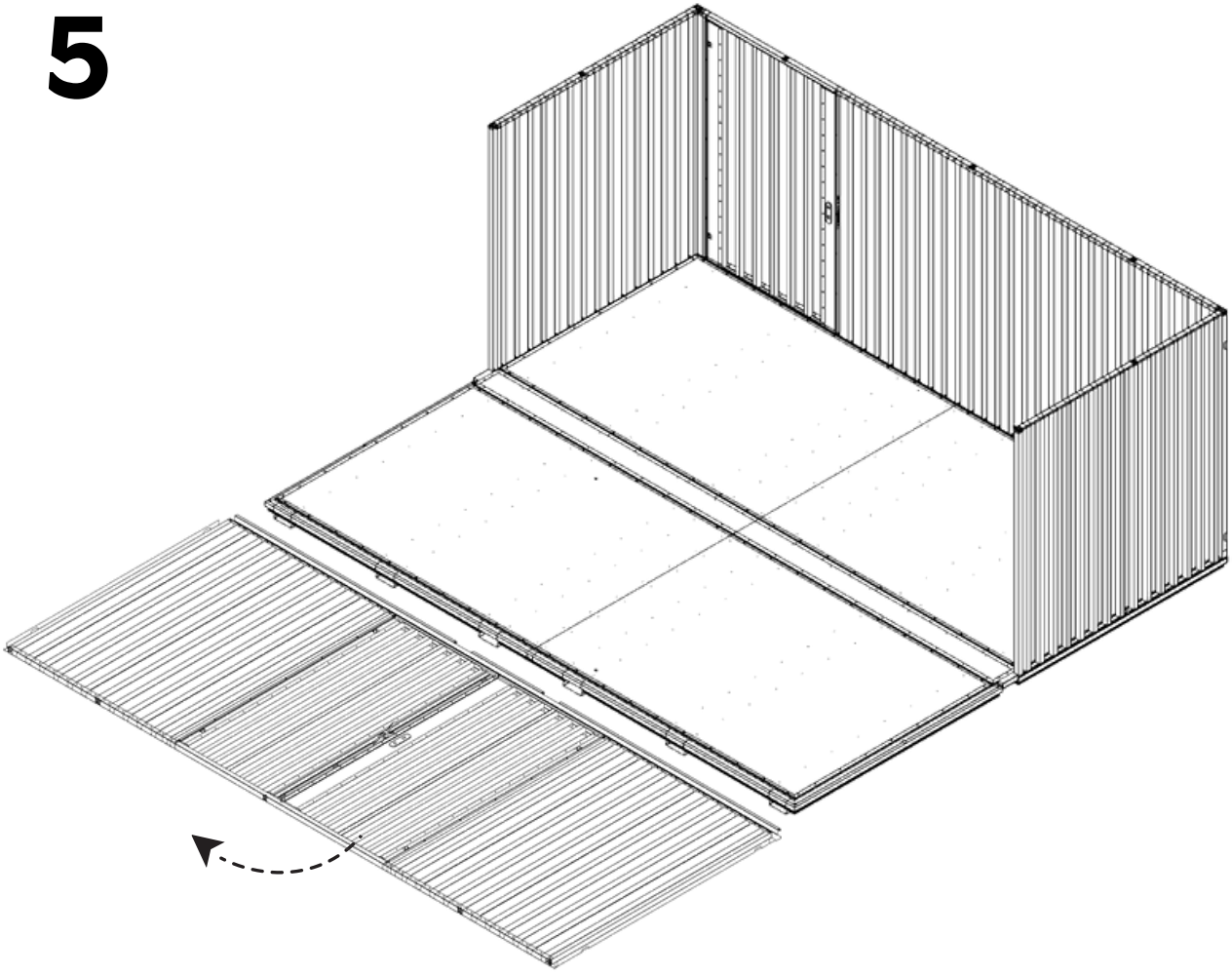

6

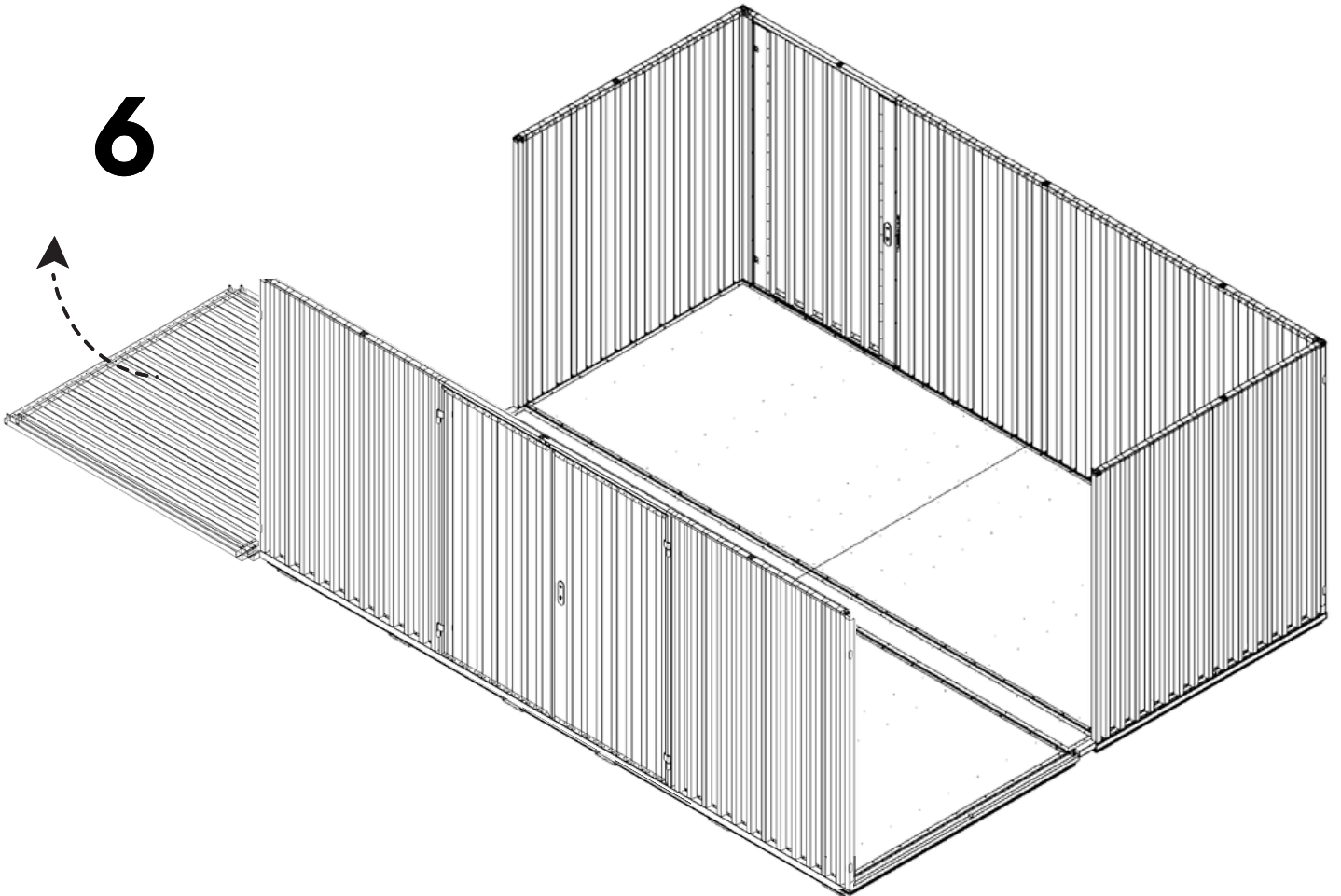

7

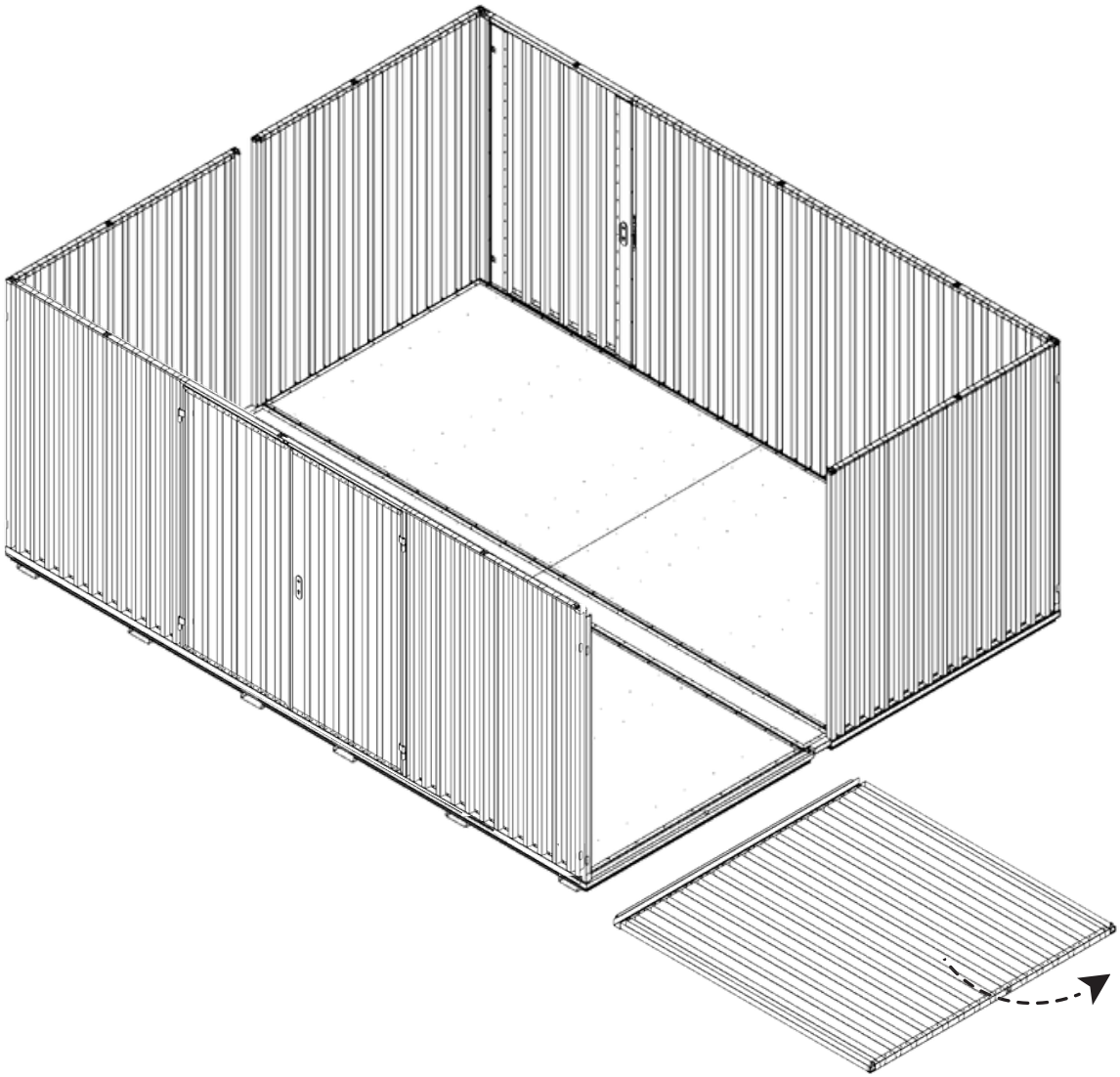

7.1

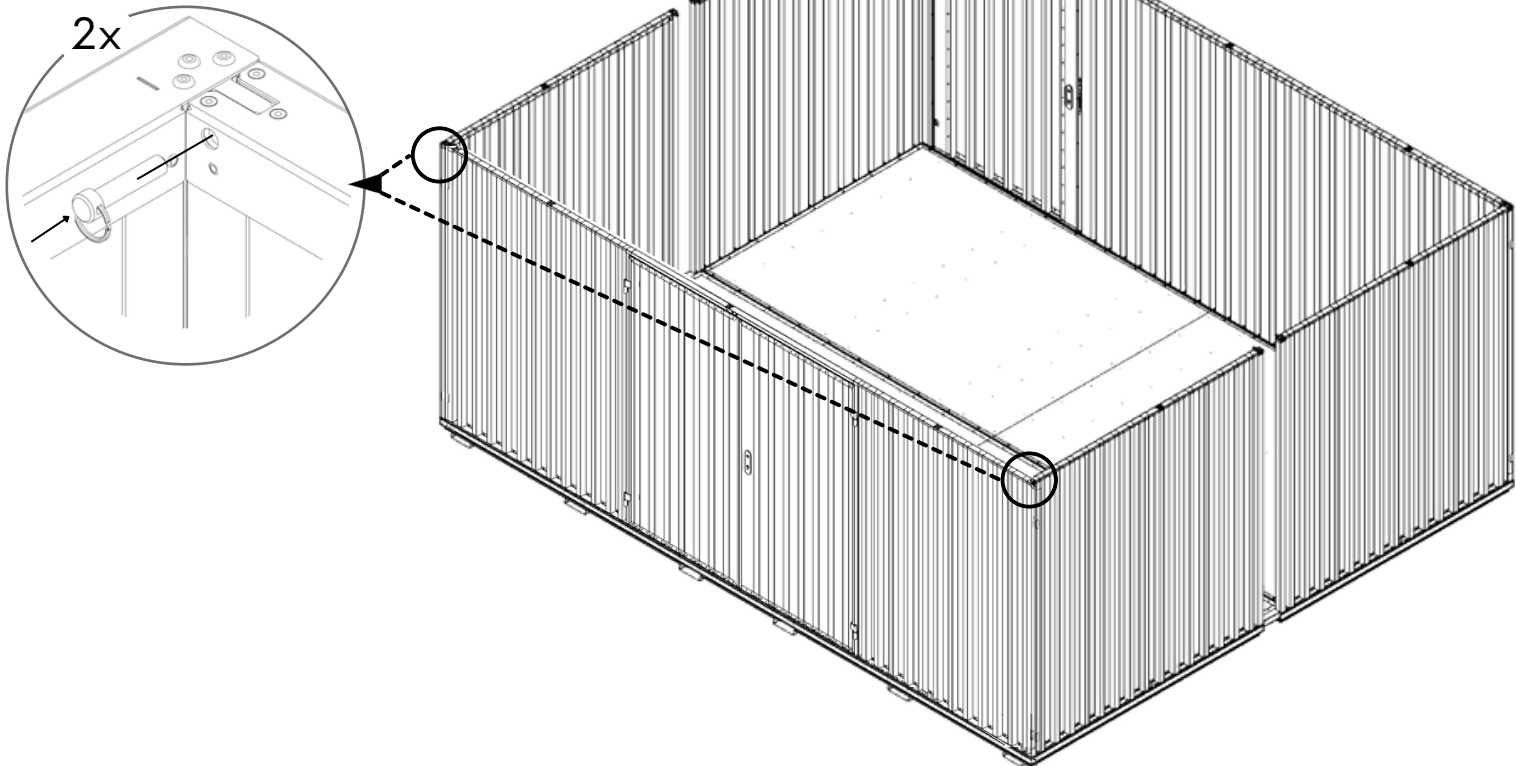

8

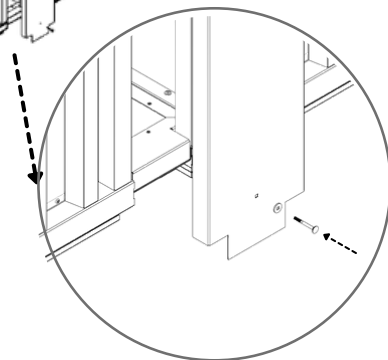
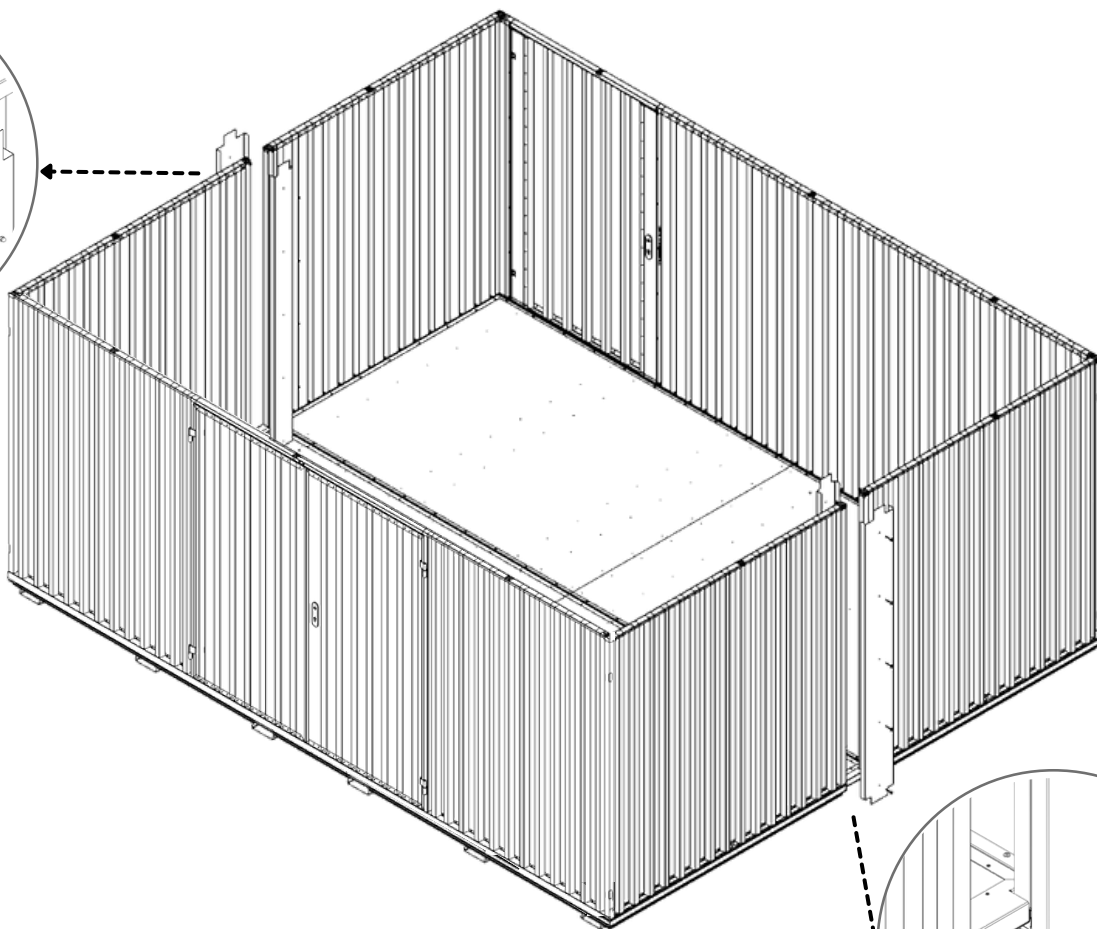
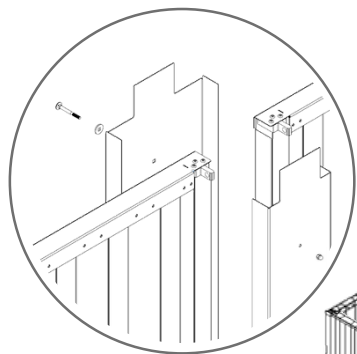

8.1

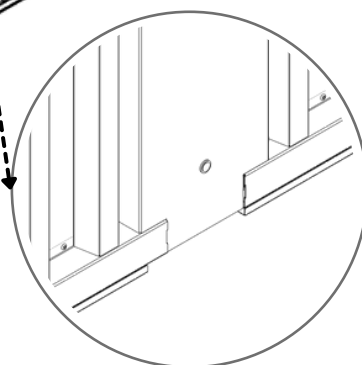
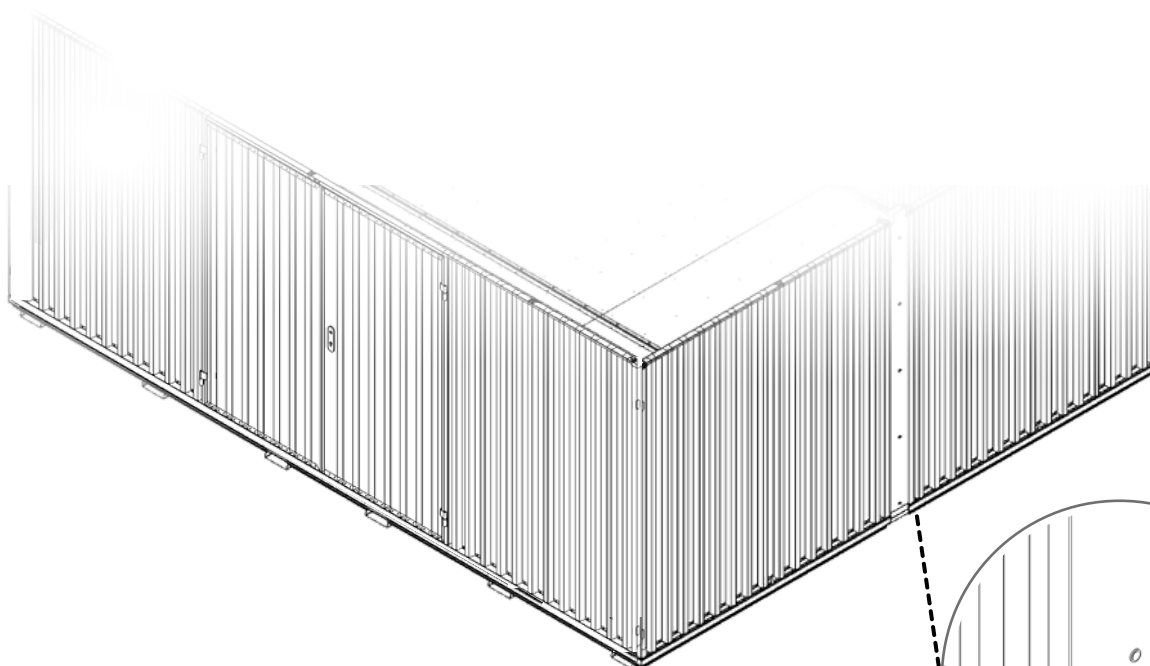



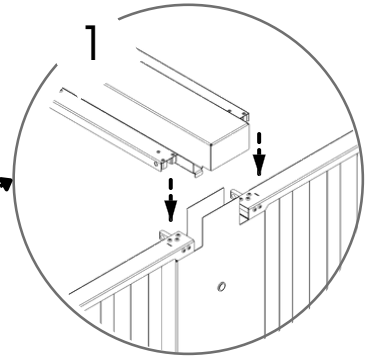
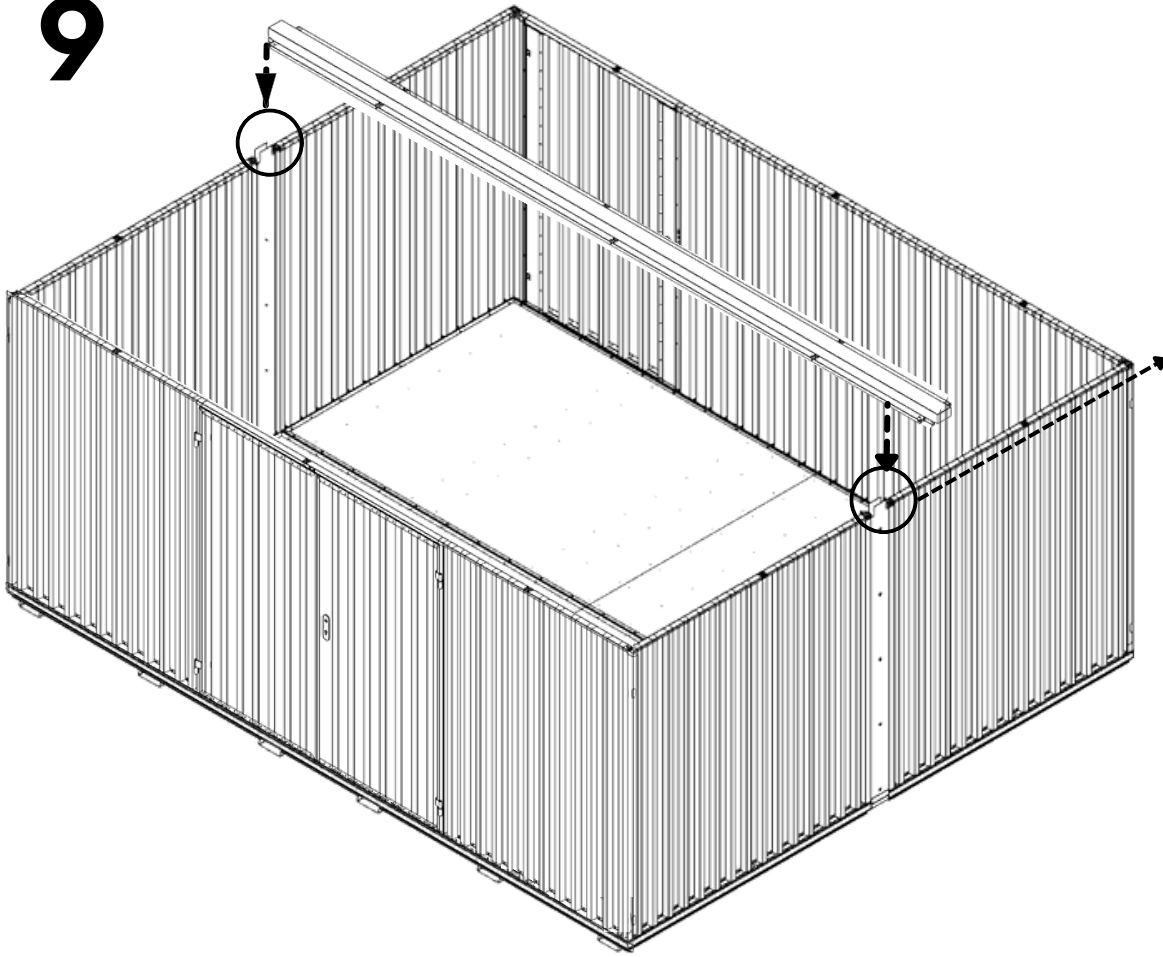



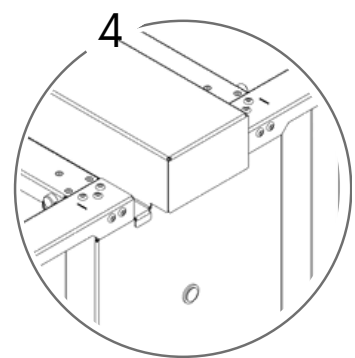
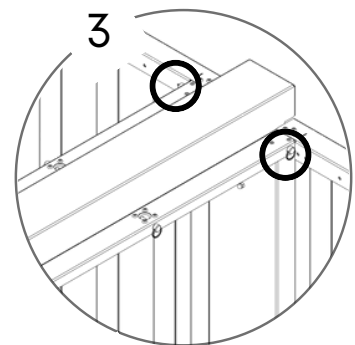
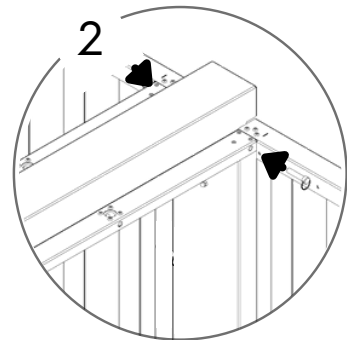
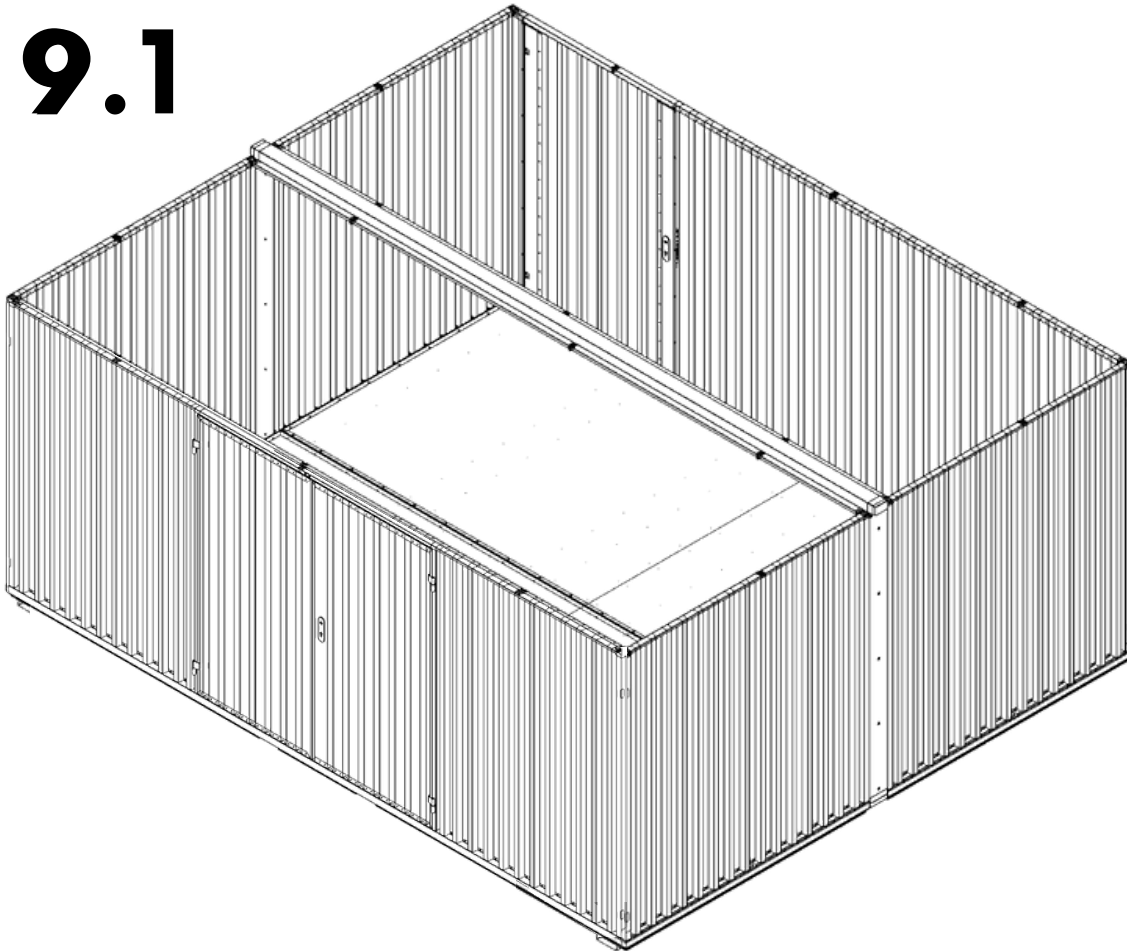

9



9.1





 898 KG	 1640 MM	Model Code: 505.110.430.440 Production Tracking Code:/X09.1.505.430.440	 9001	 14001	 50001			
---	--	---	---	--	--	---	---	---

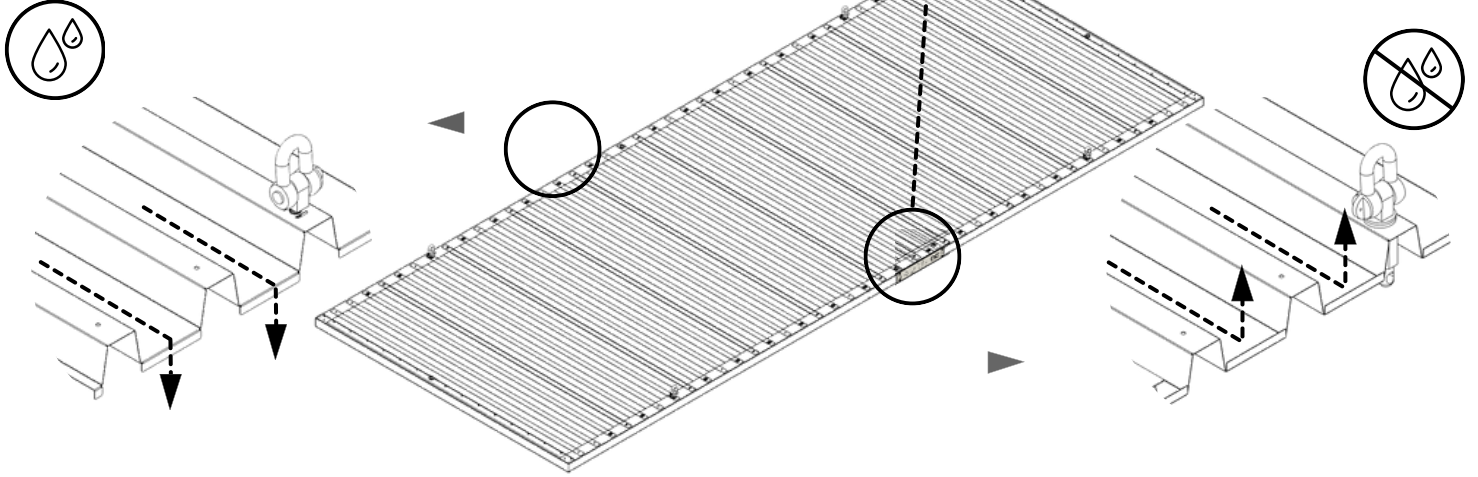

10

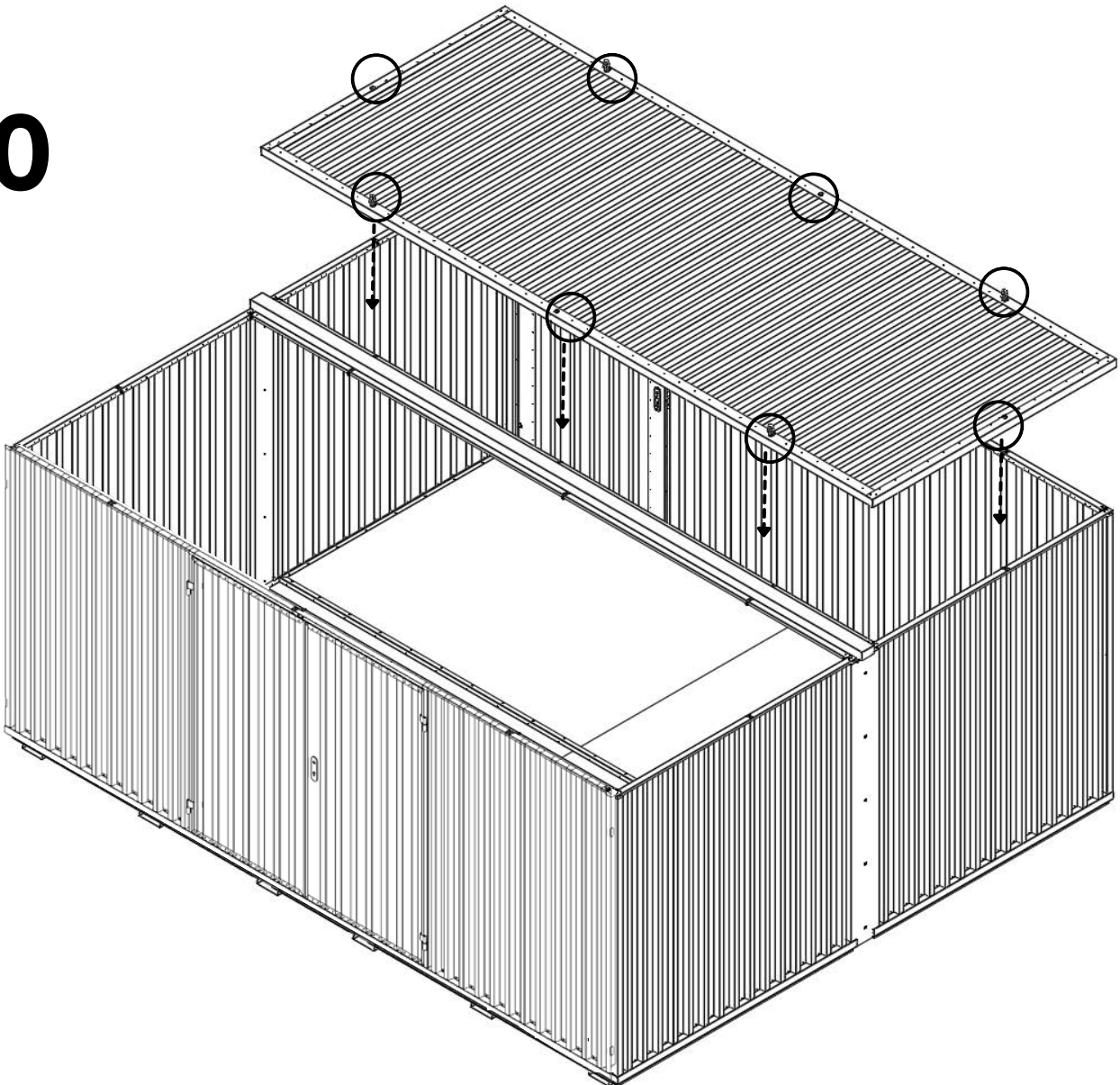

11

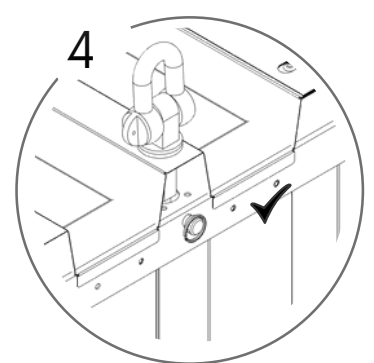
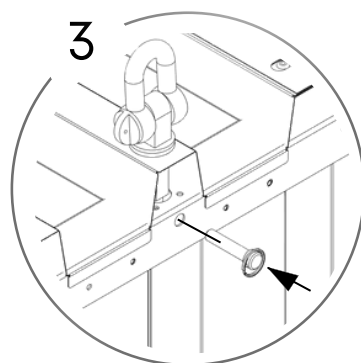
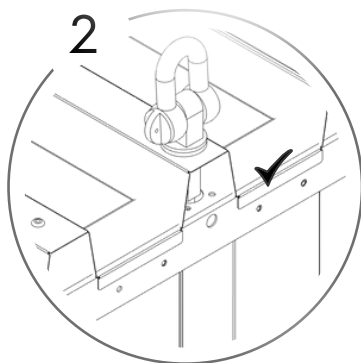
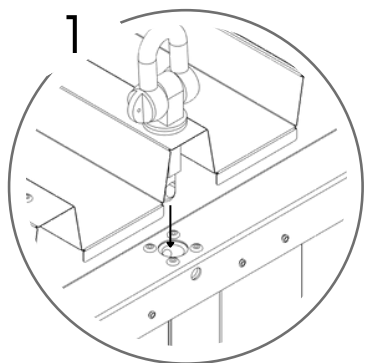
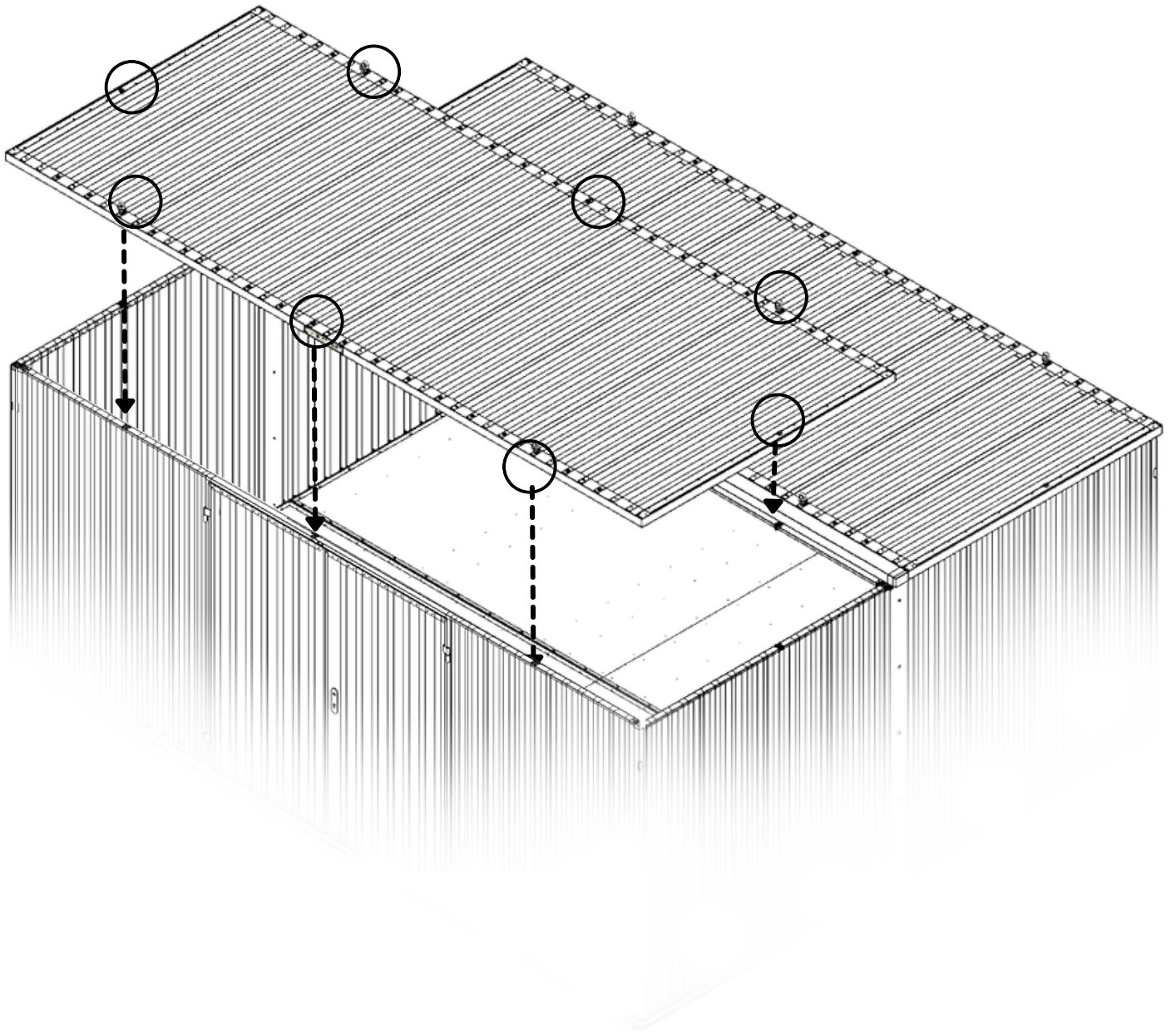

12

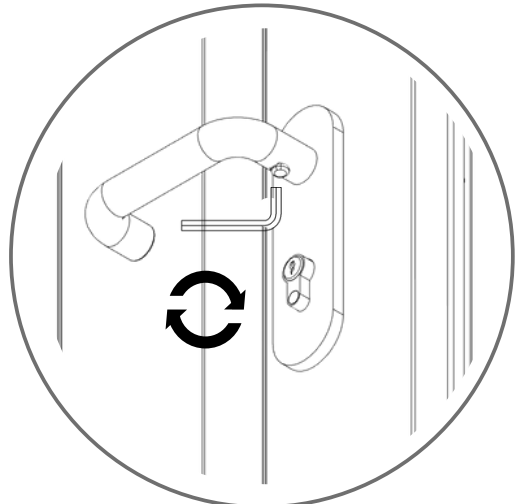
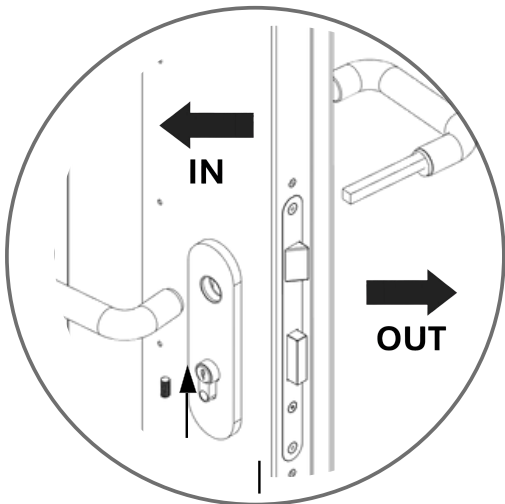
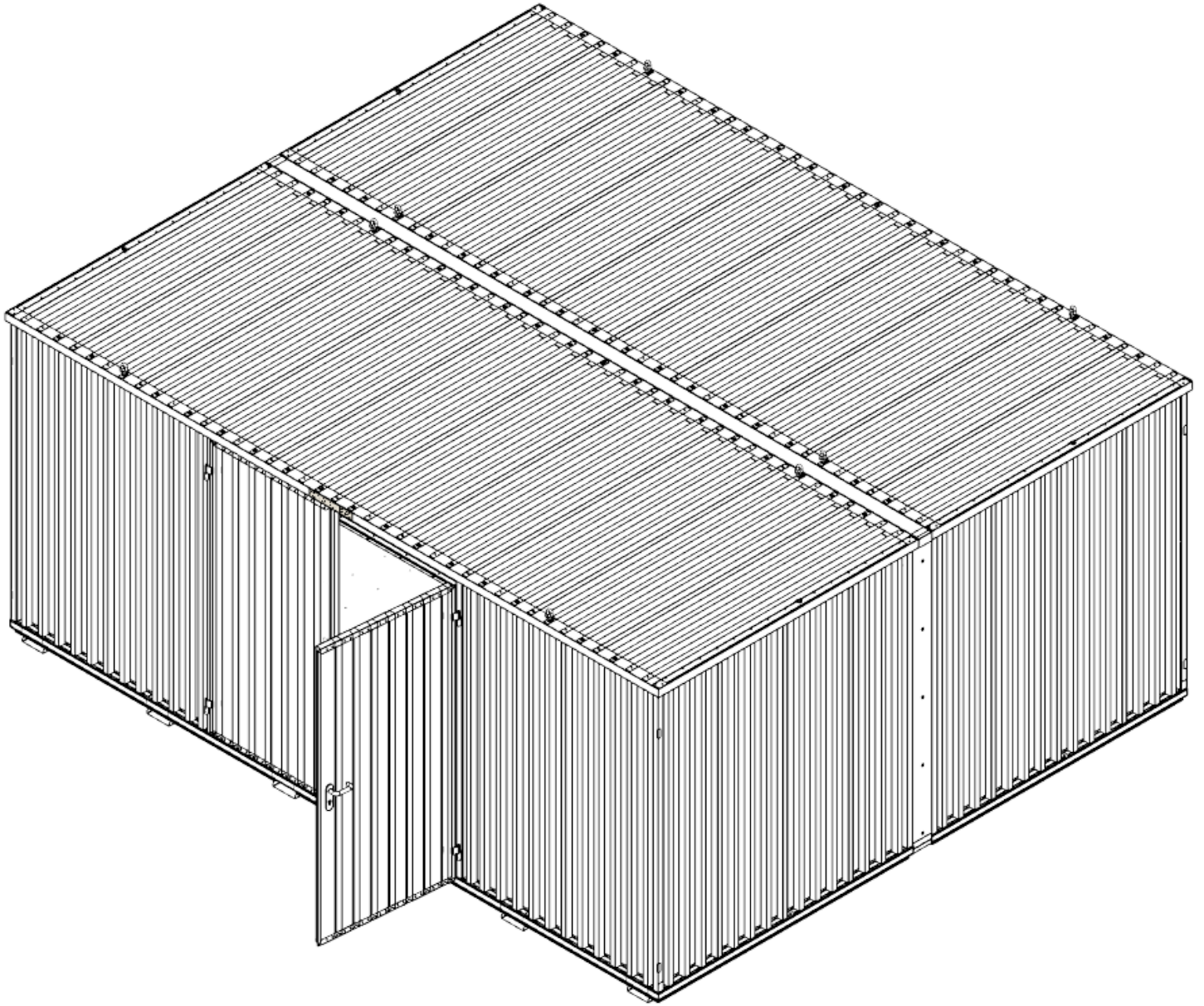

13

