

PRODUCT CODE:5050.110.440.320

prefabase
Quick Build Solutions

Instructions and User Guide

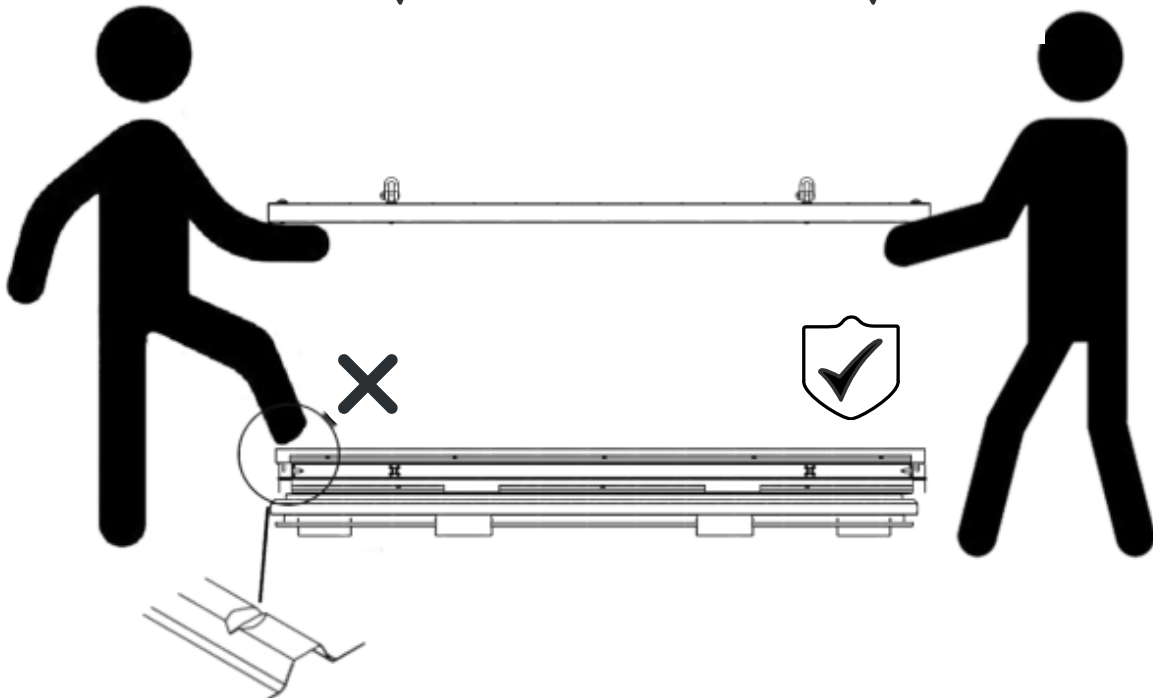
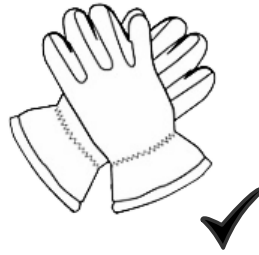
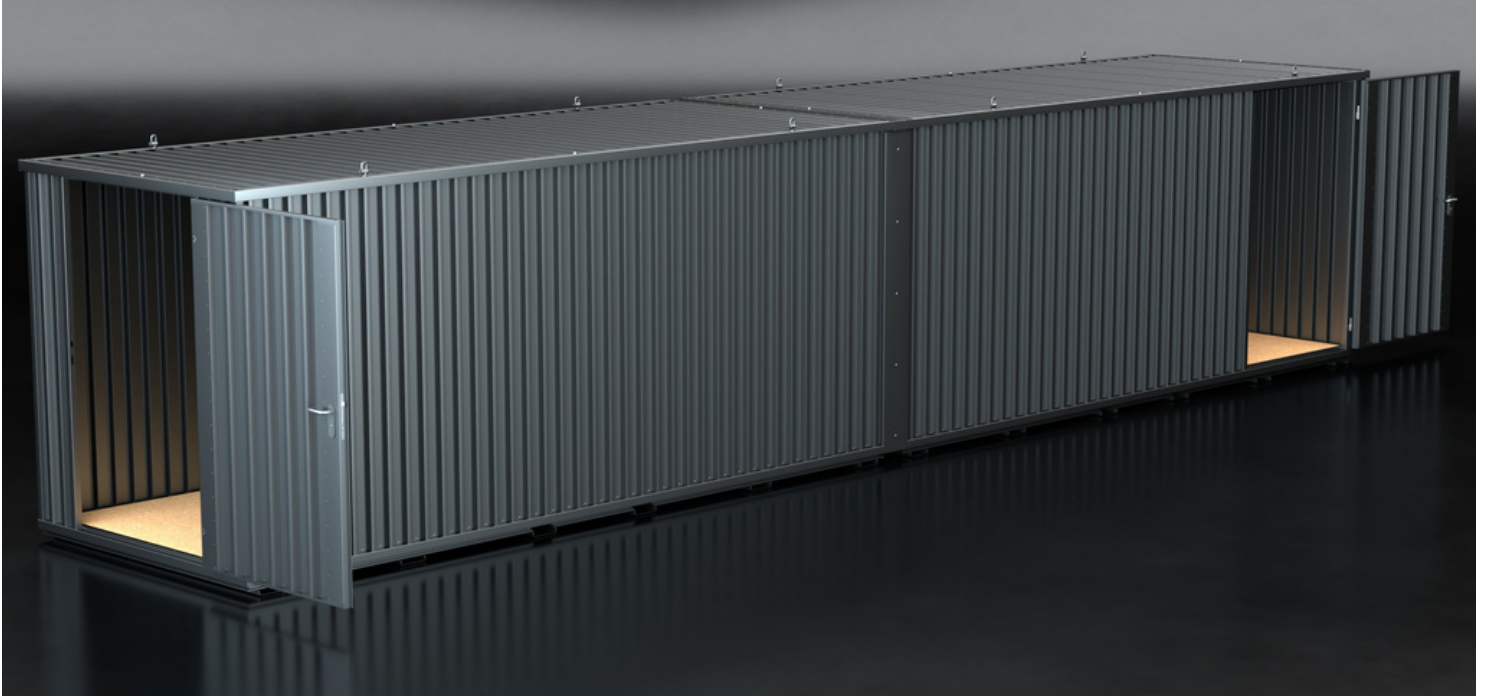

50.0110

2x

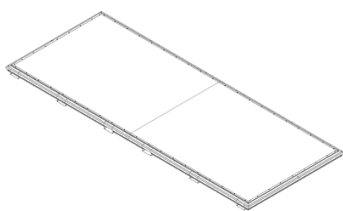

50.0510

2x

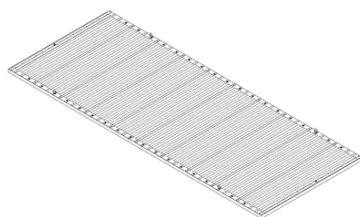

306.0110

1x



306.0510

1x



50.0410

3x

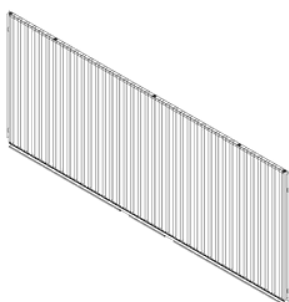

50.0440

1x

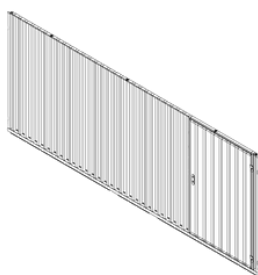

0310

1x

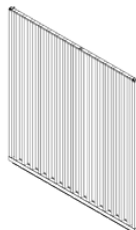

0320

1x



306.40.05

2x



306.40.04

2x



61.101

4x



24x

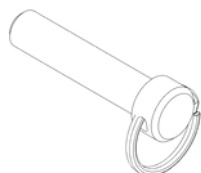

2x

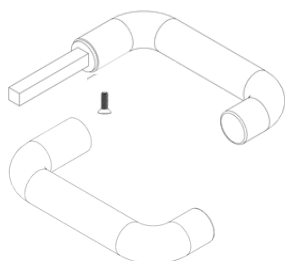

10x



10x



10x



1x



2x



1

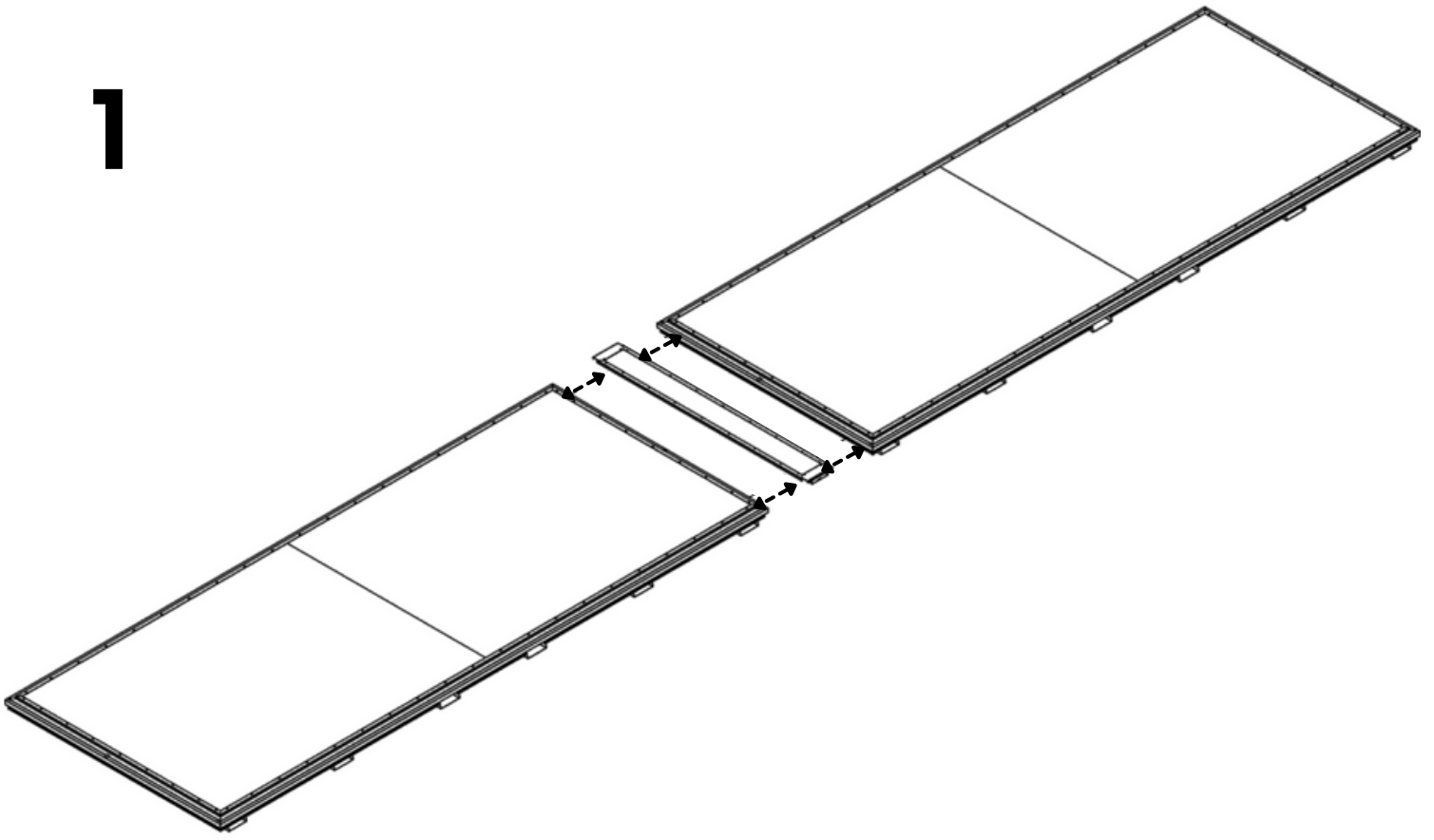

2

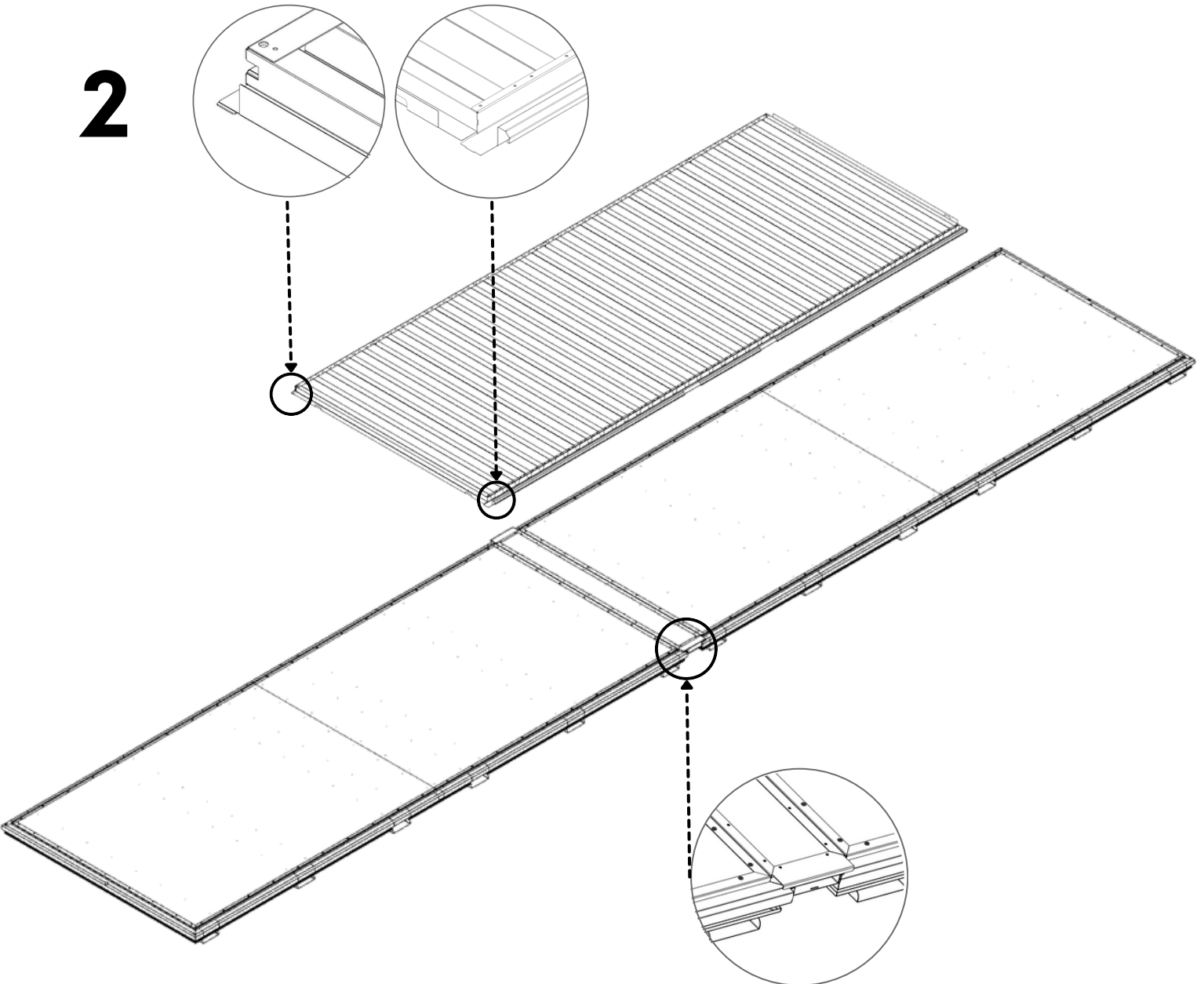

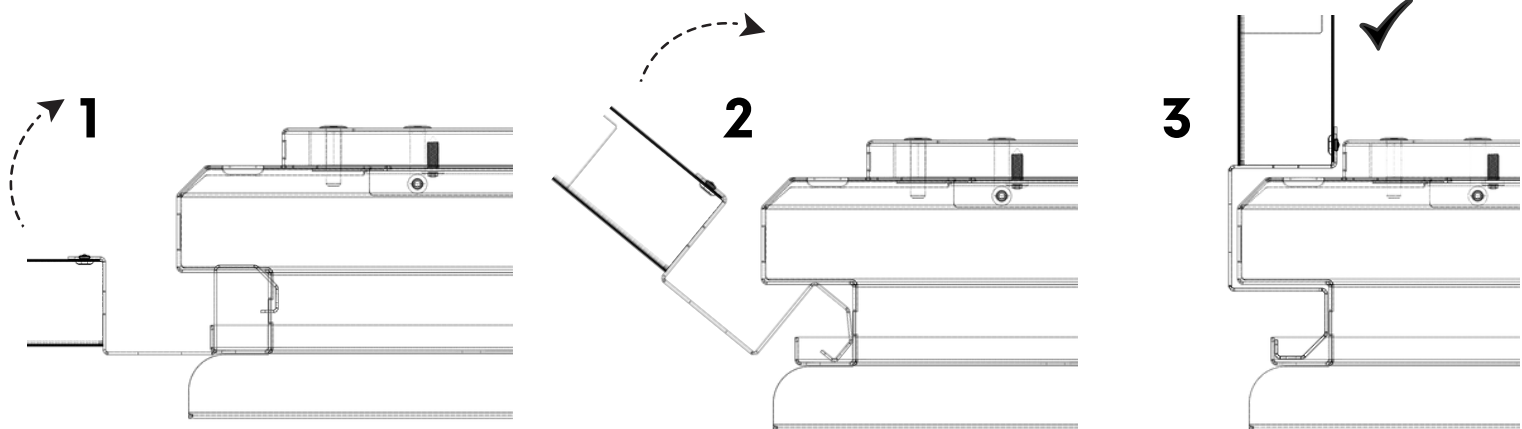

3

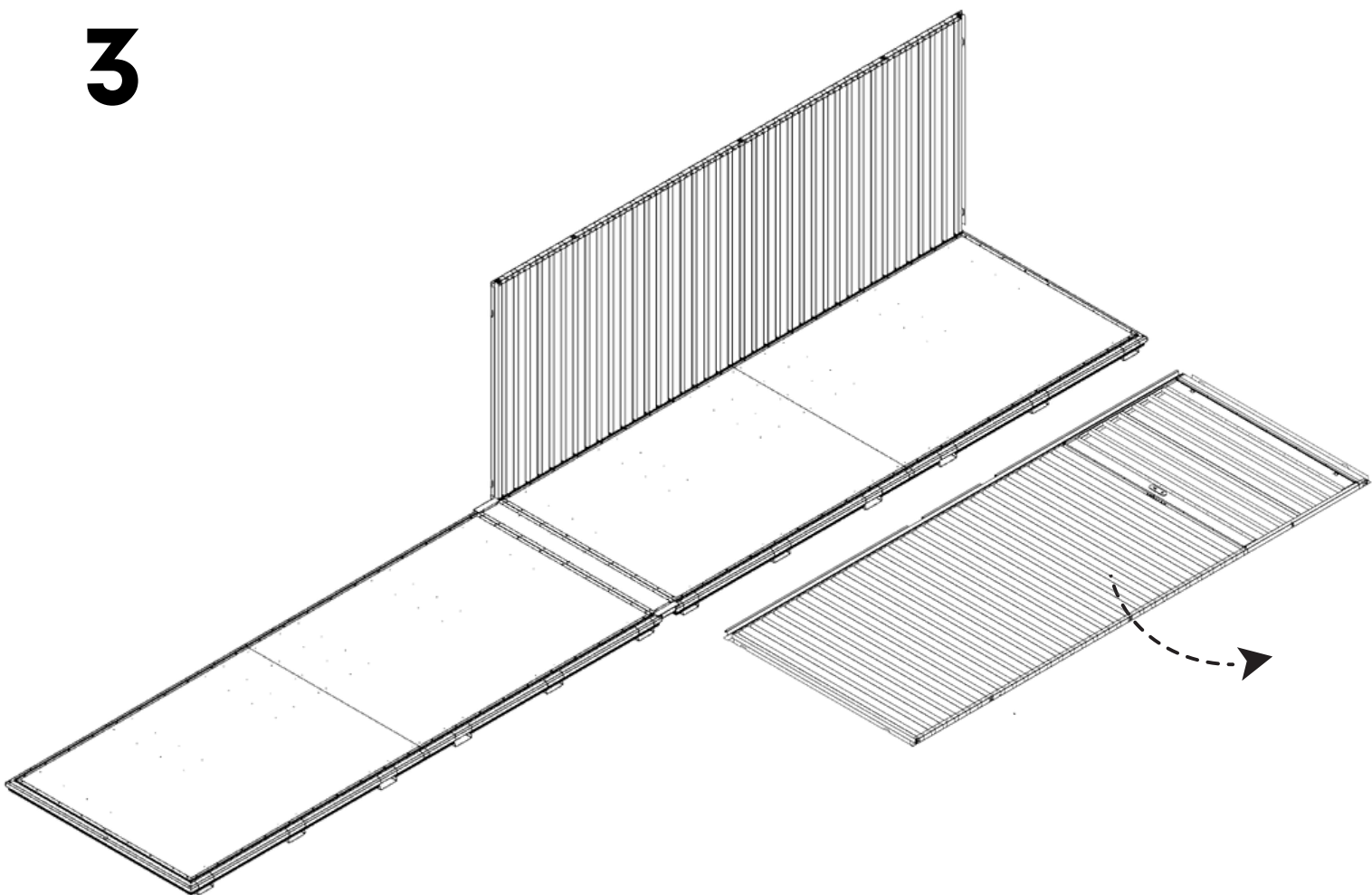

4

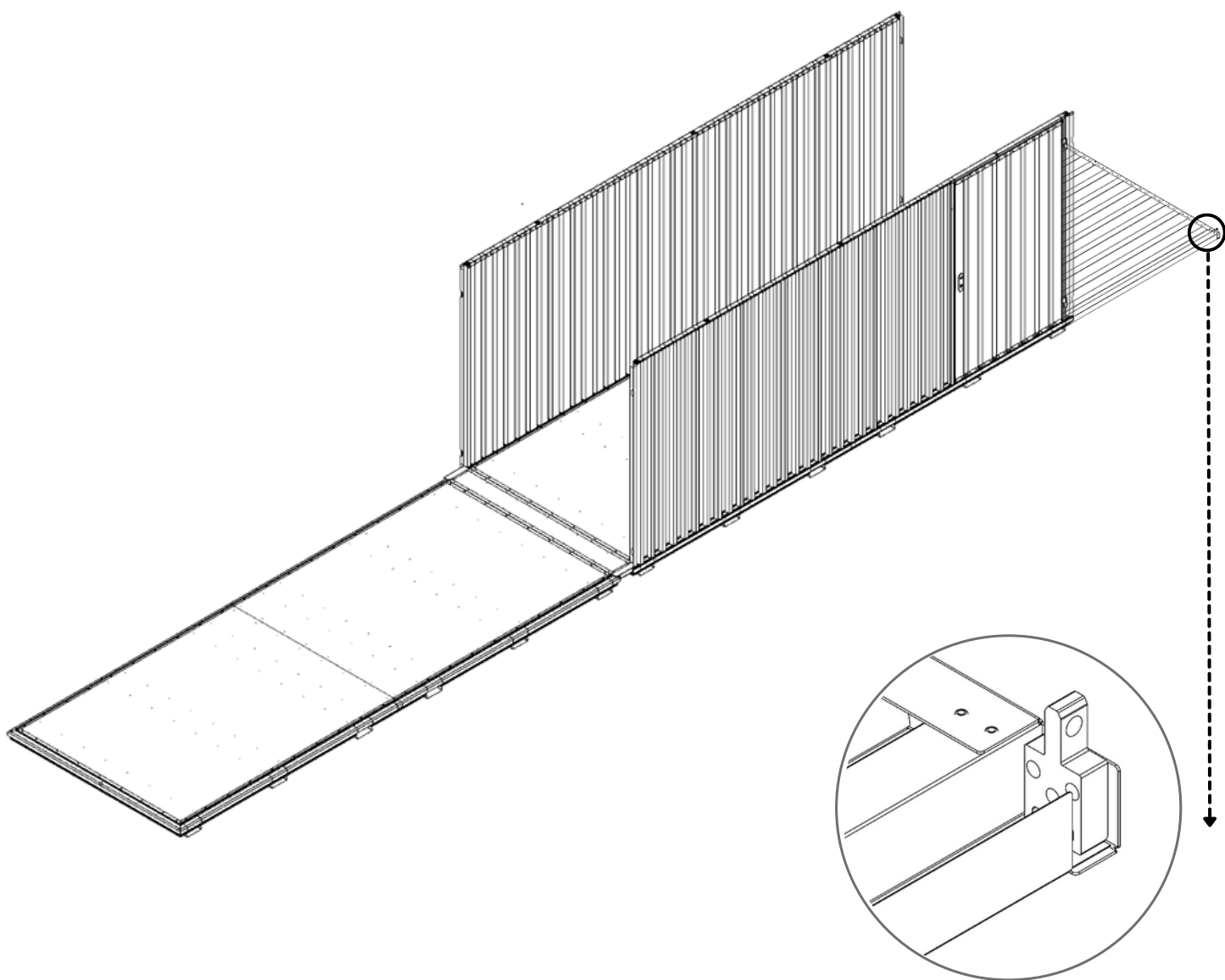

4.1

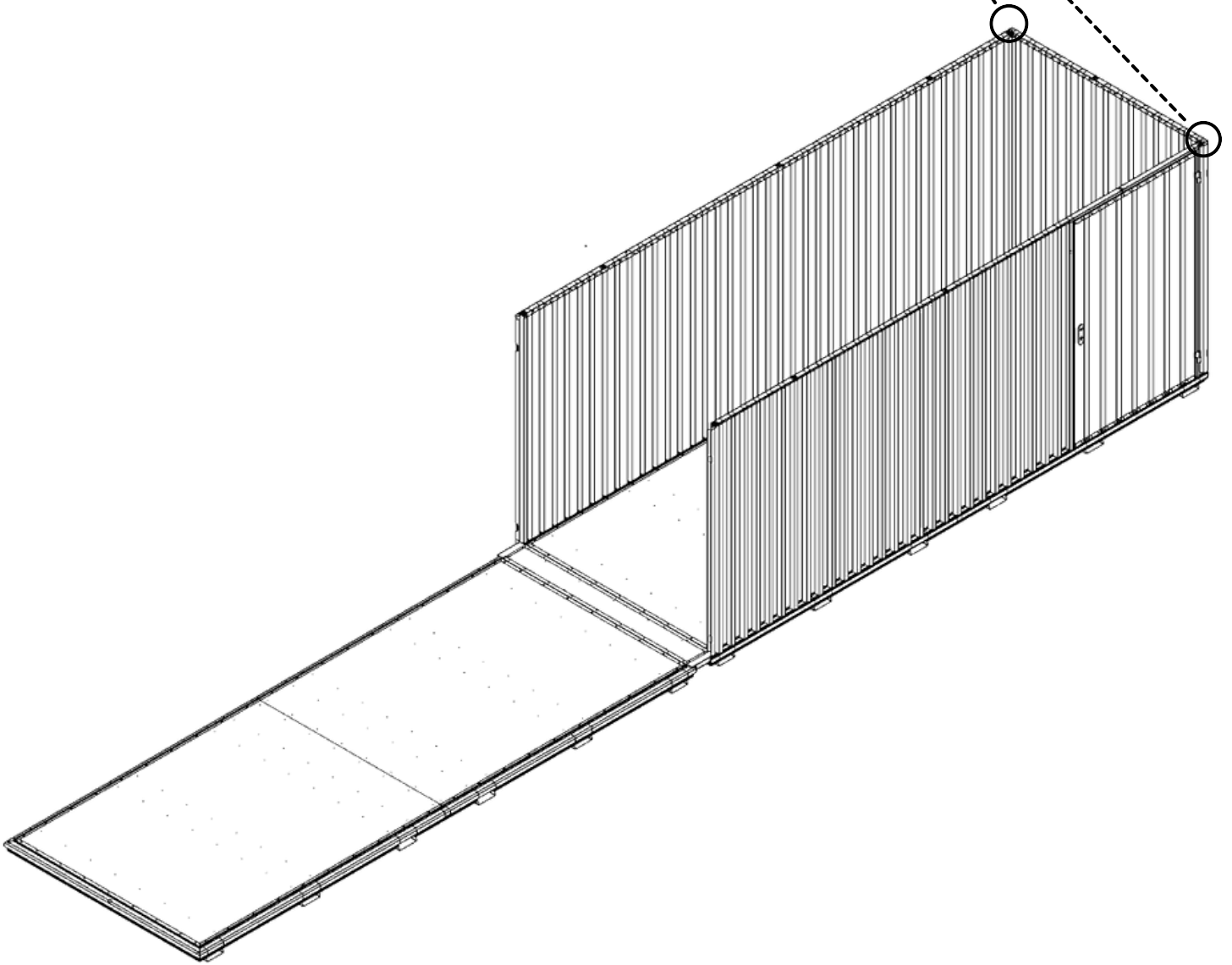
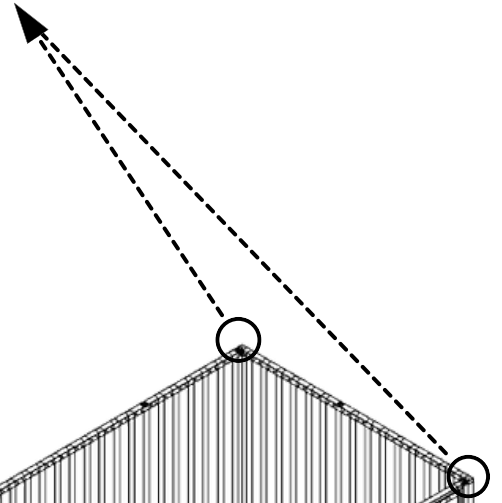
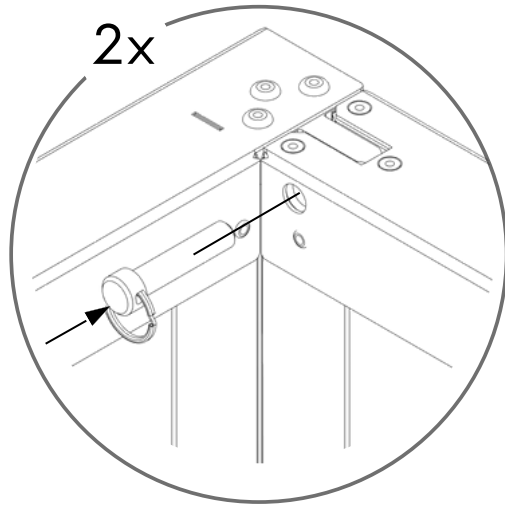

5

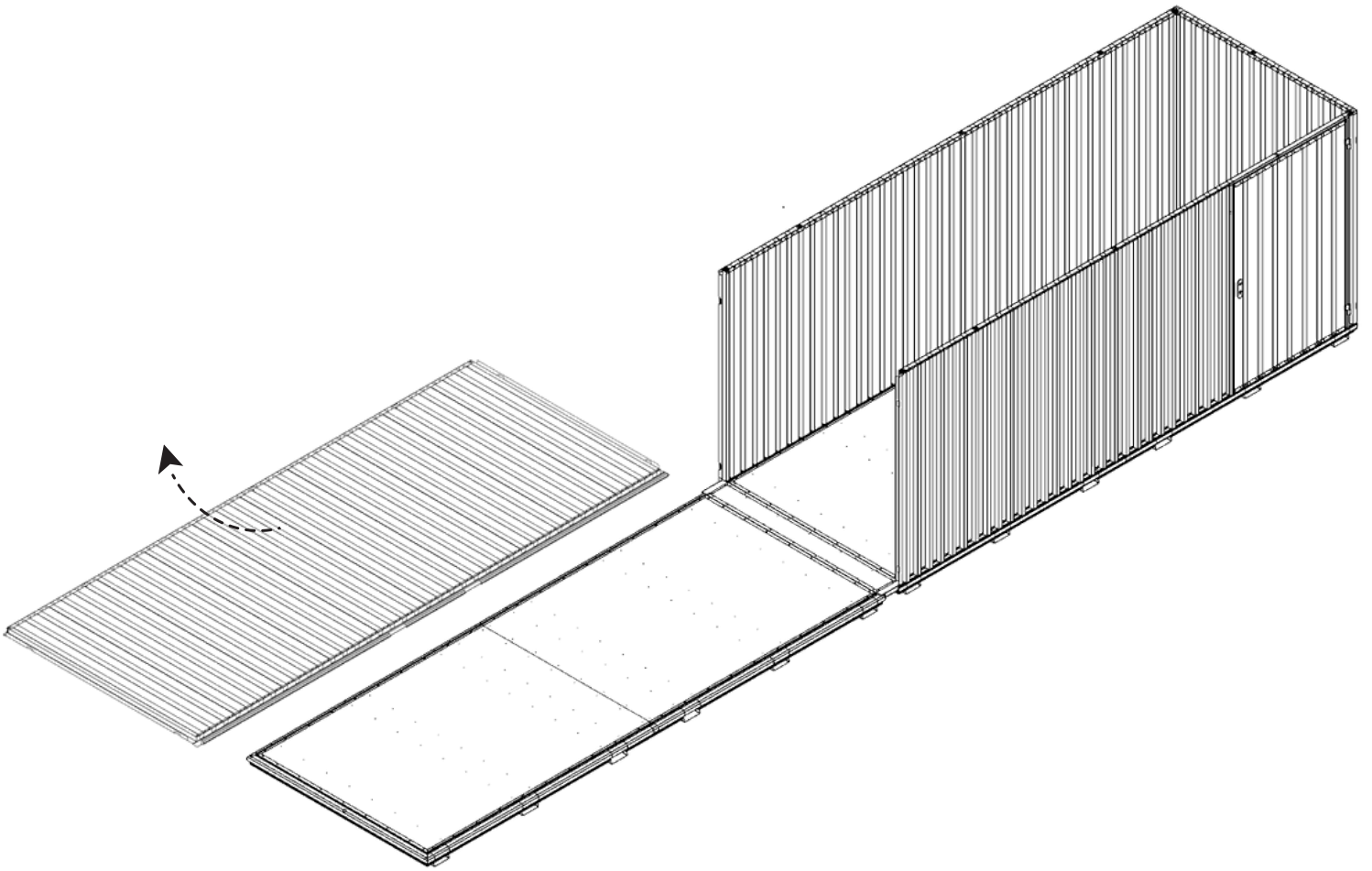

6

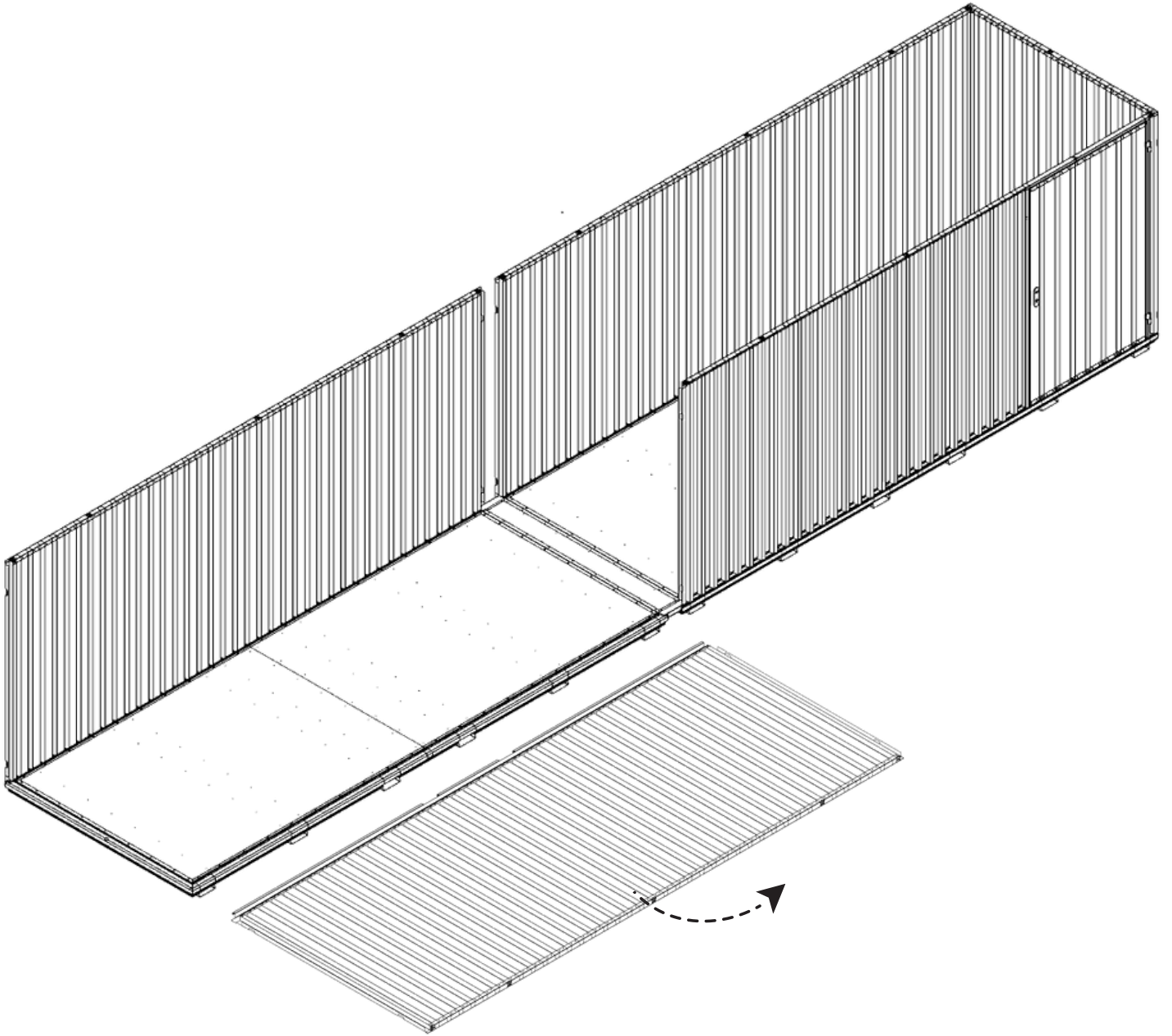

7

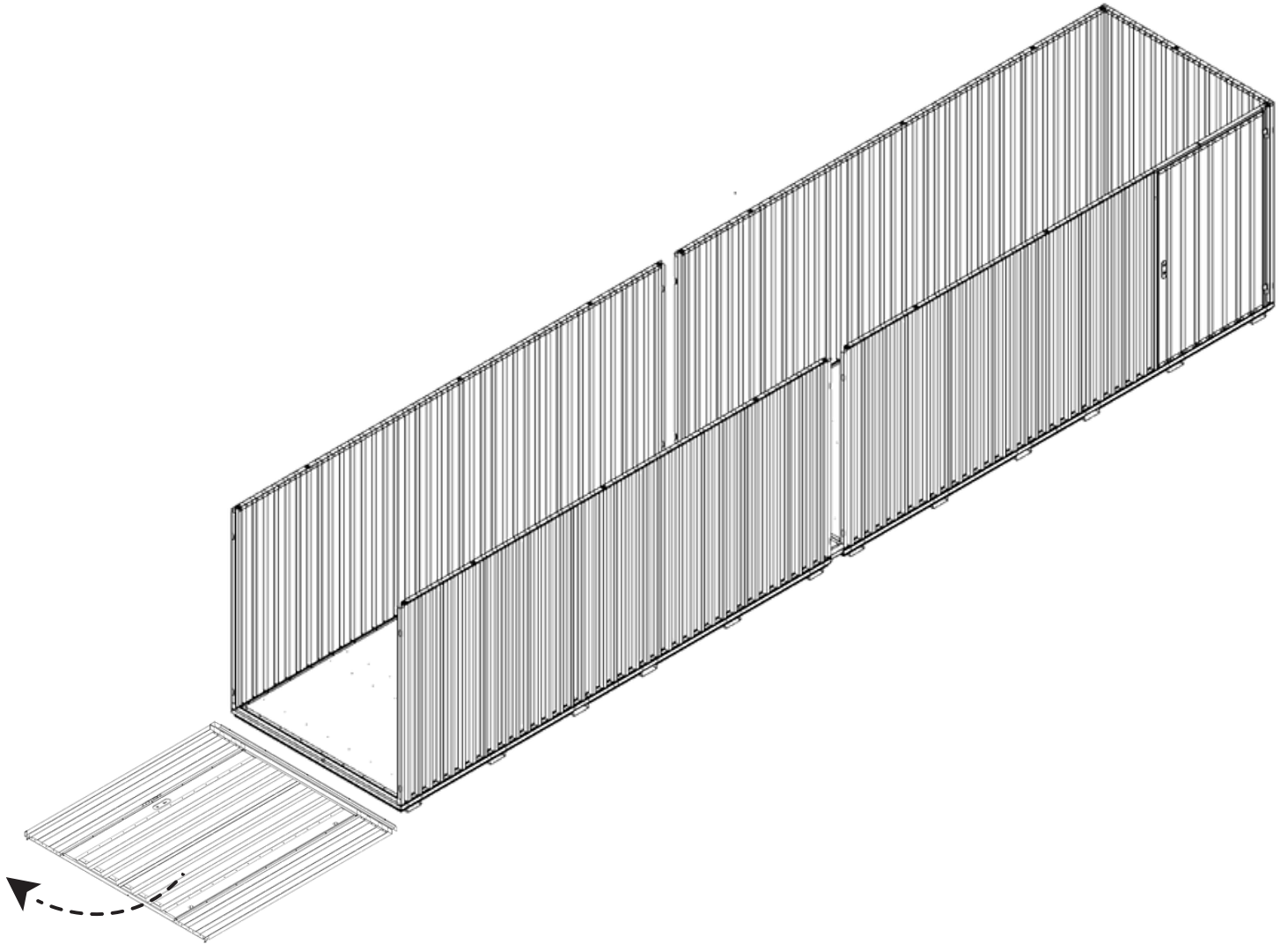

7.1

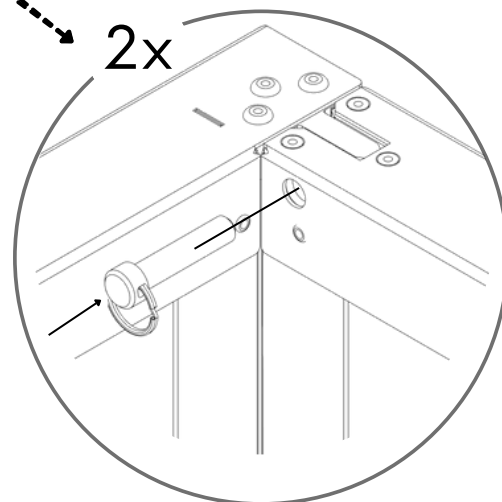
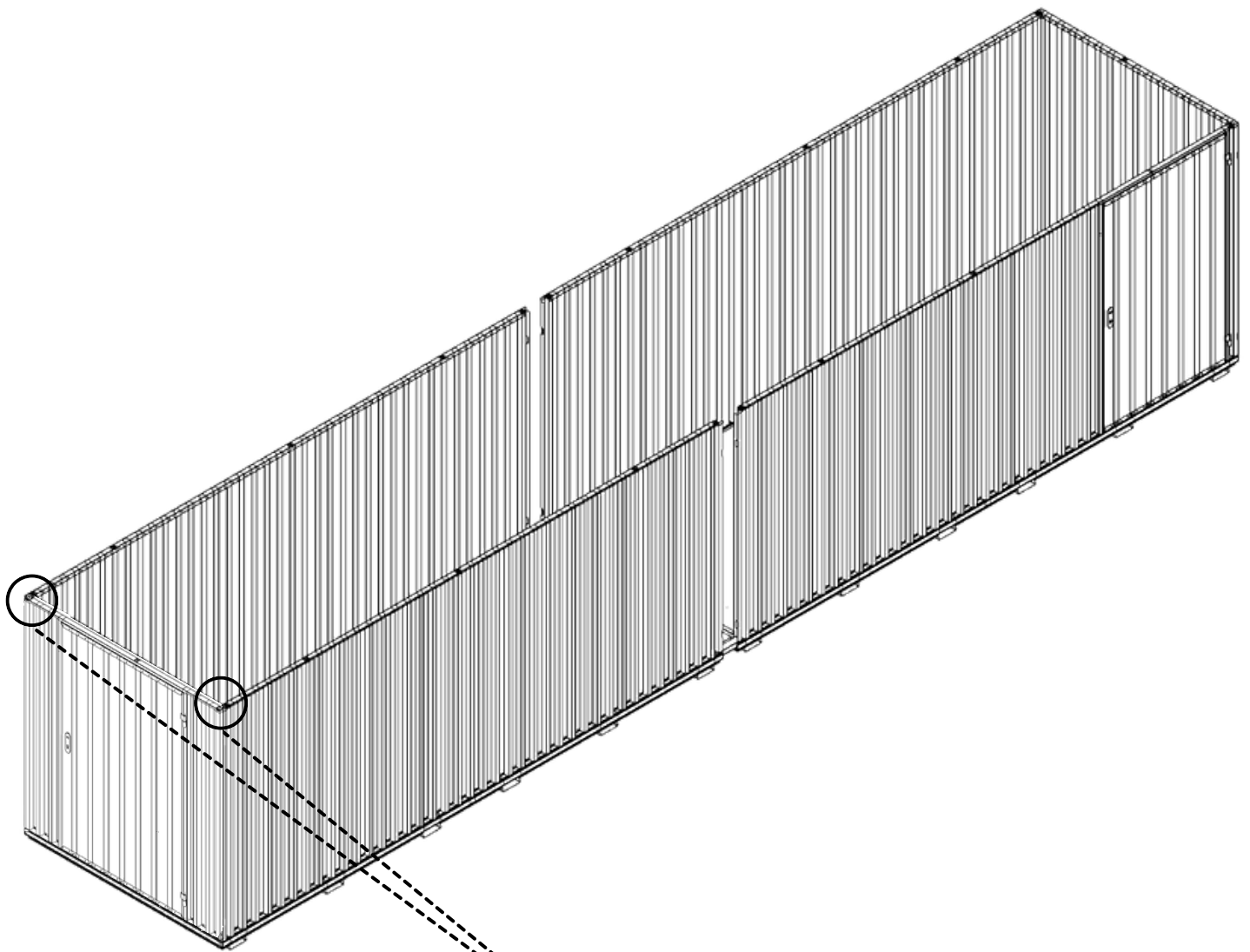

8

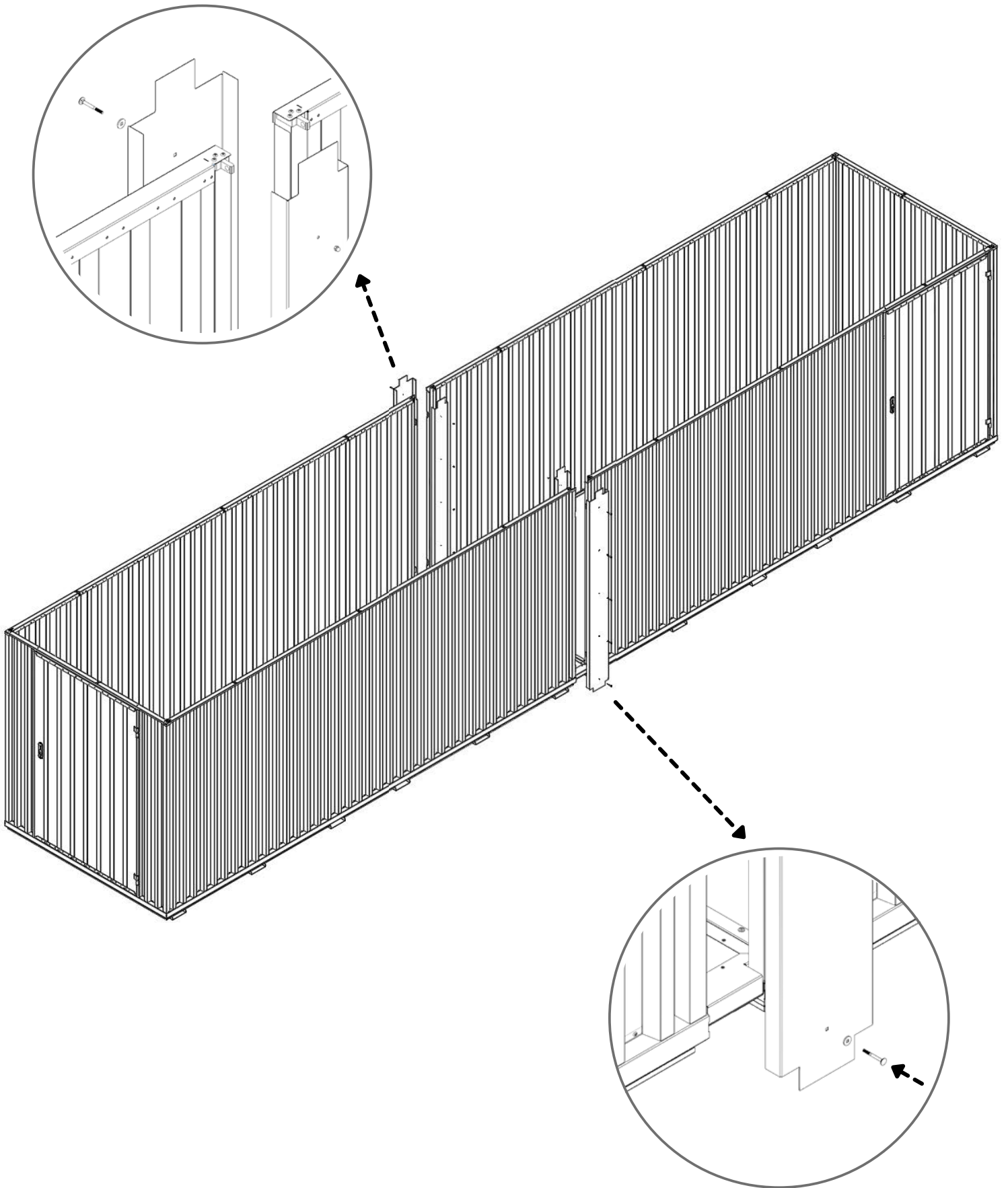

9

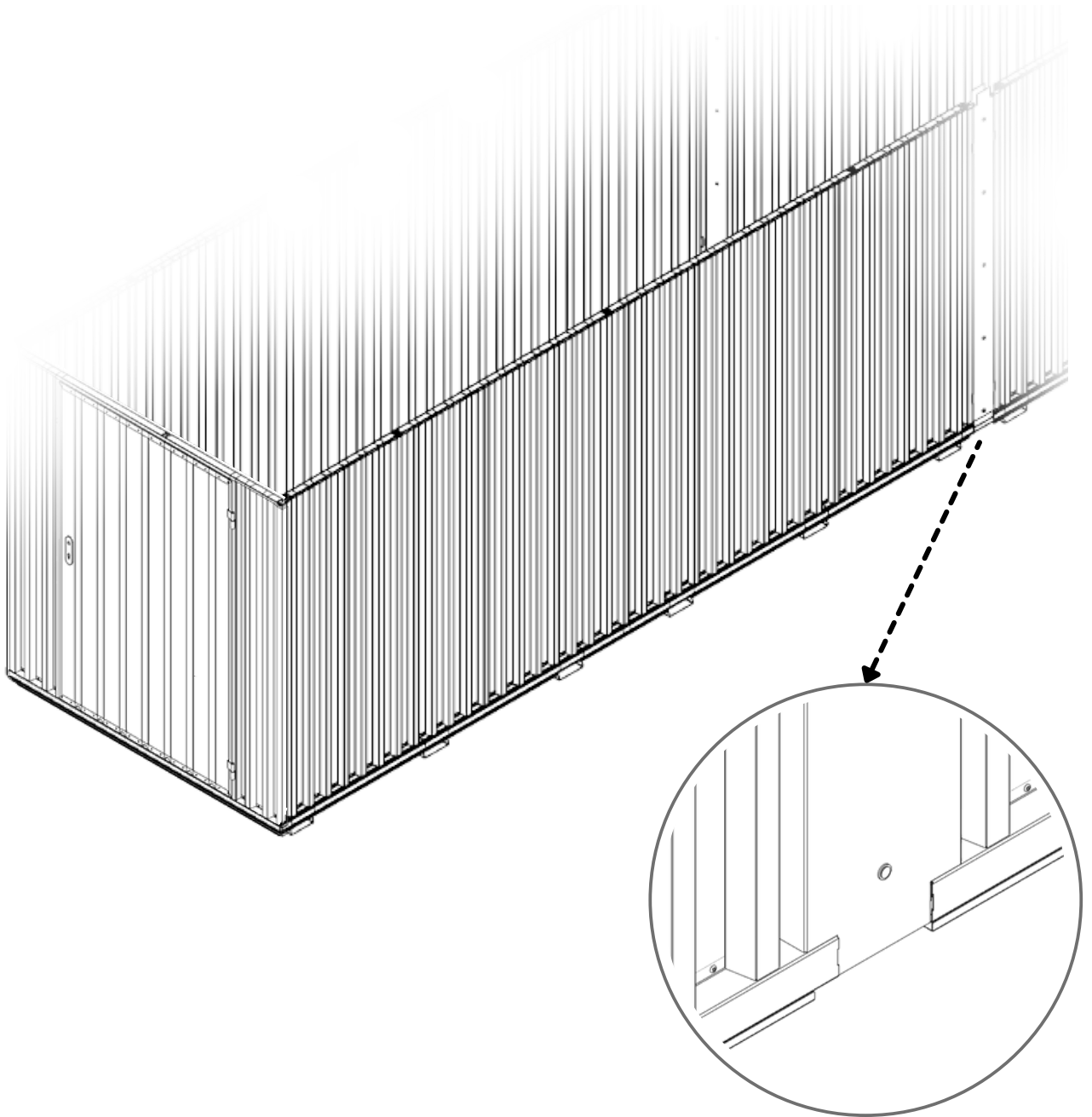



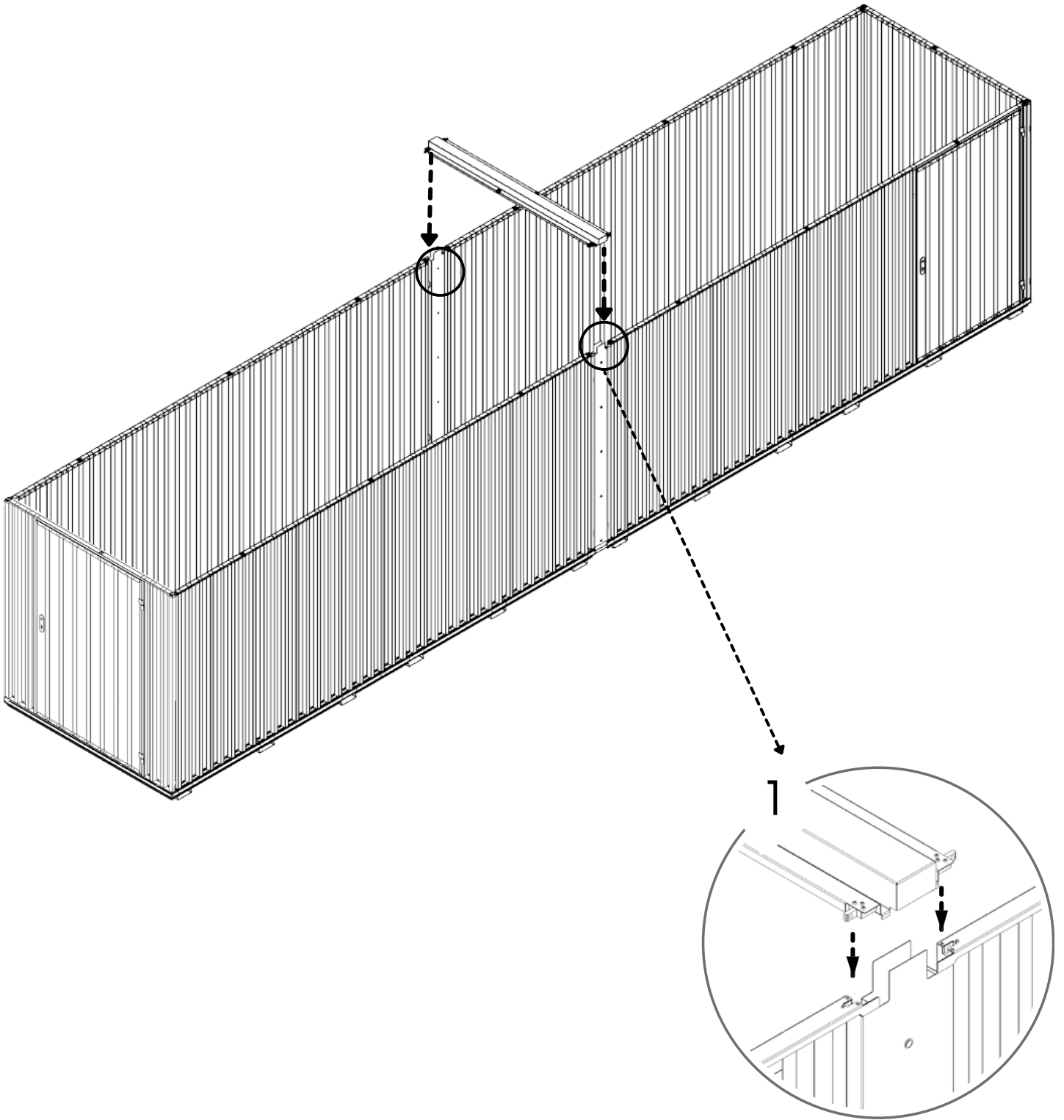



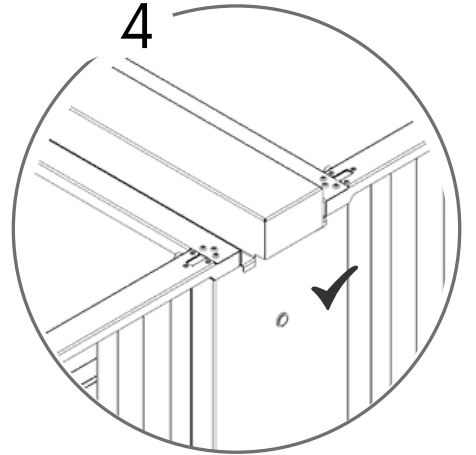
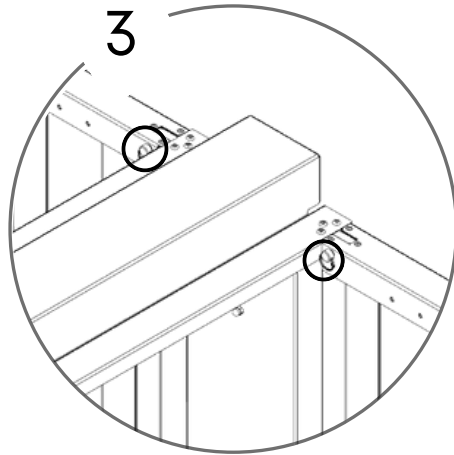
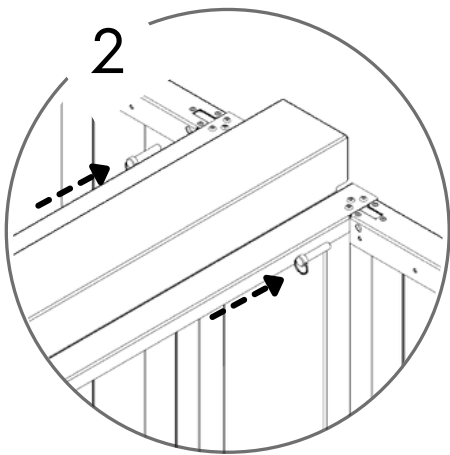
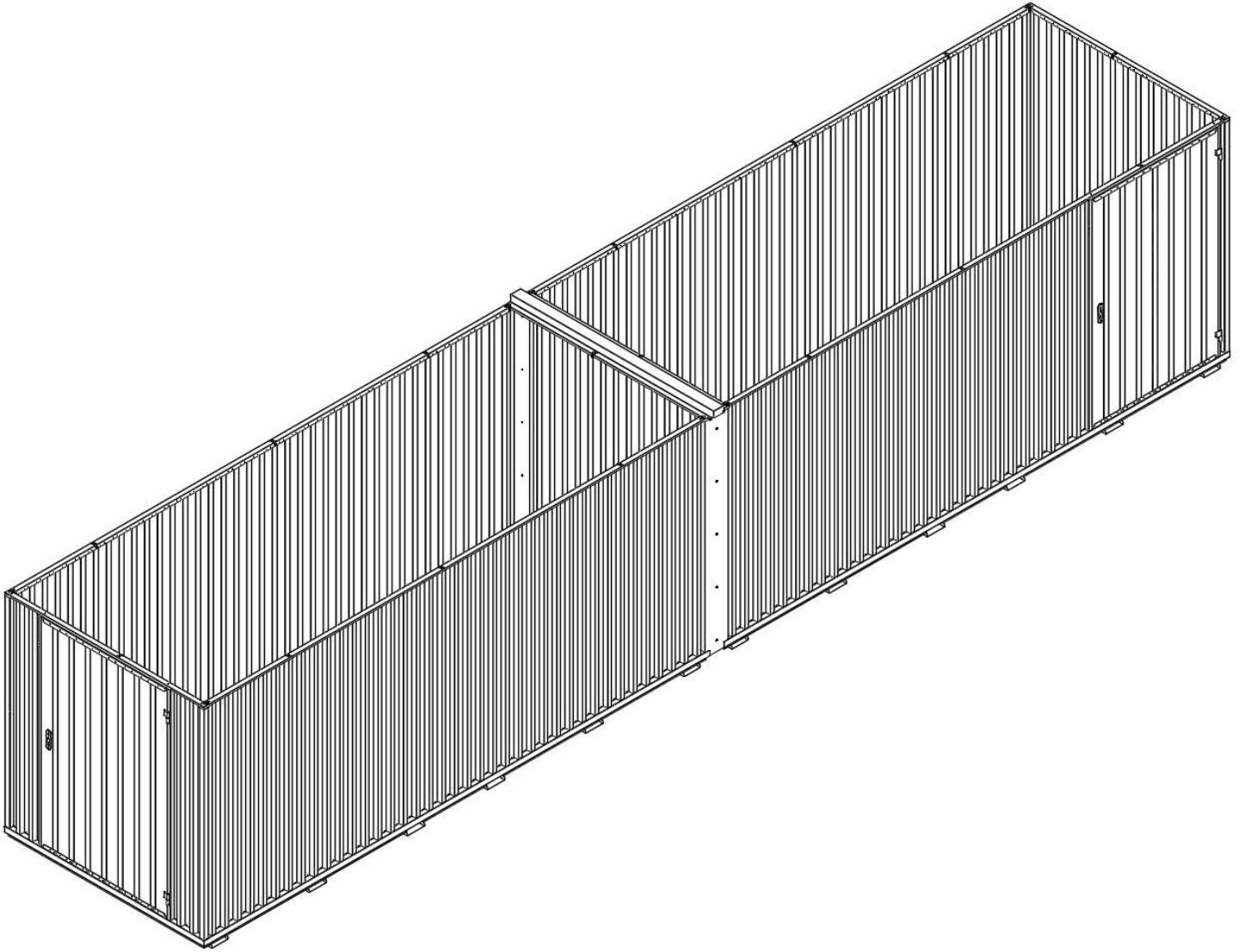

10



11





 954 KG	 1640 MM	Model Code: 5050.110.440.320 Production Tracking Code:/X09.1.5050.440.320	 9001	 14001	 50001			
---	--	---	---	--	--	---	---	---

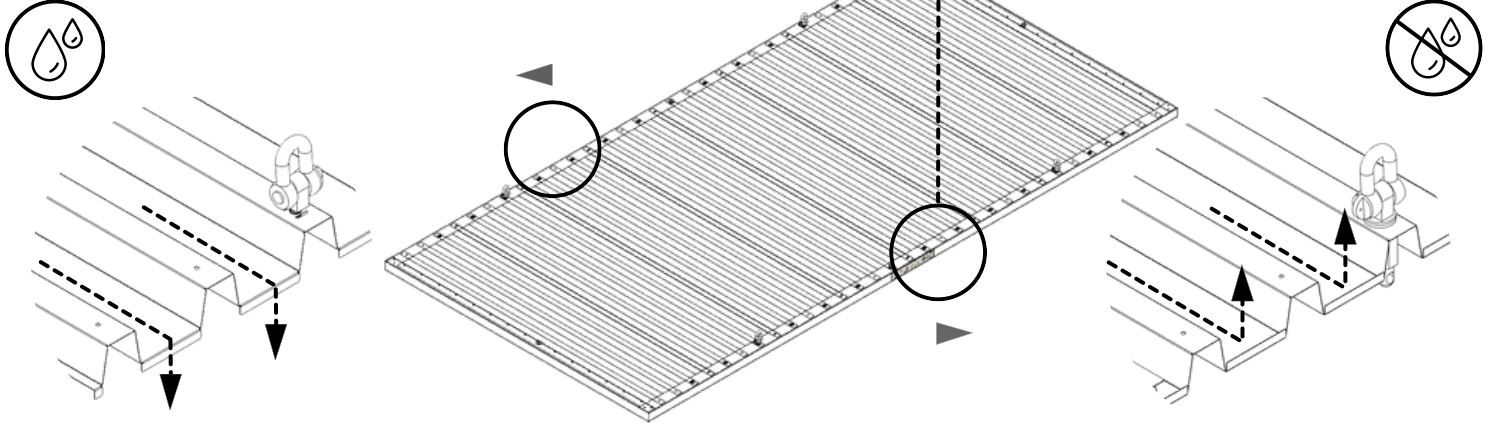

12

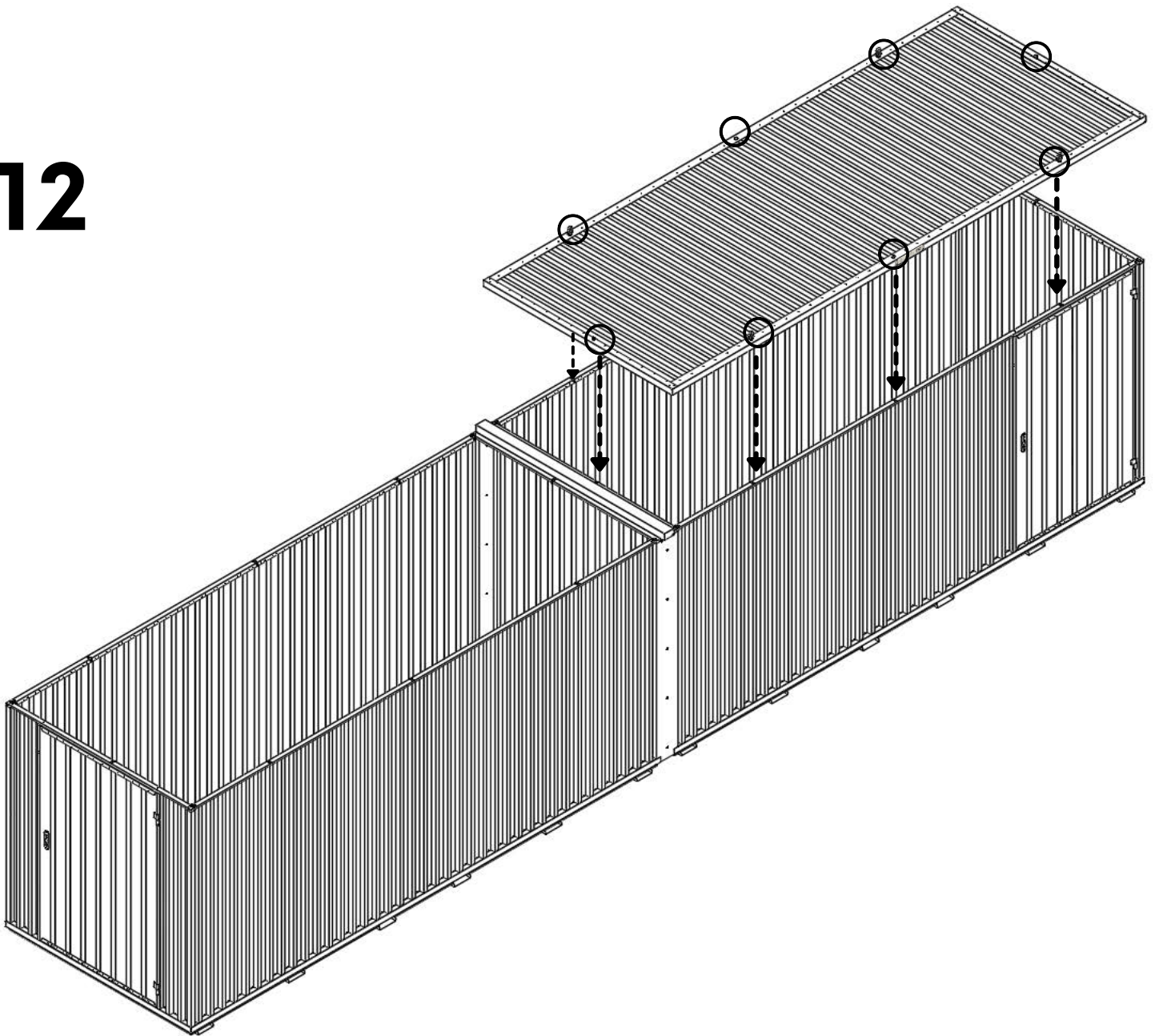

13

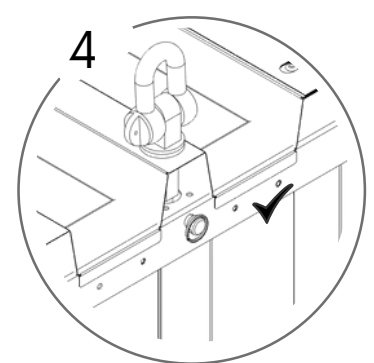
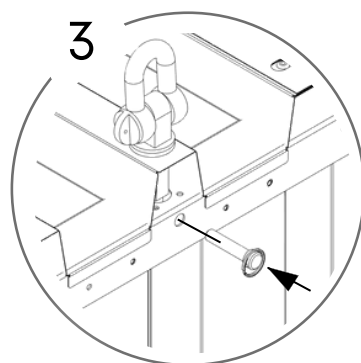
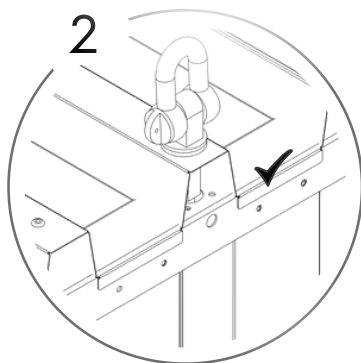
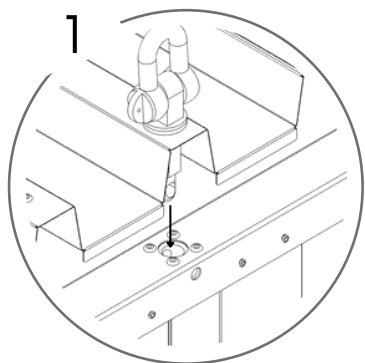
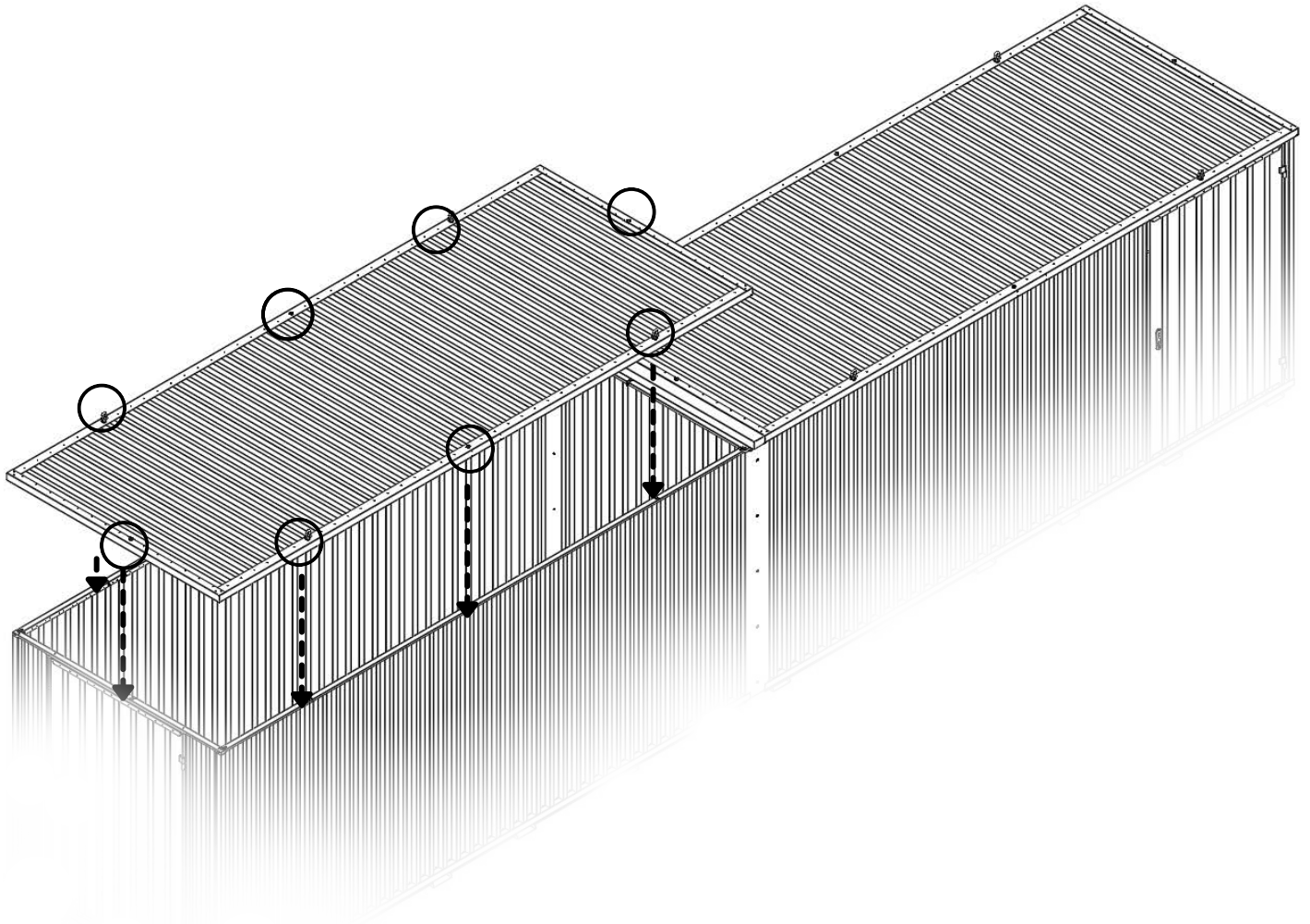

14

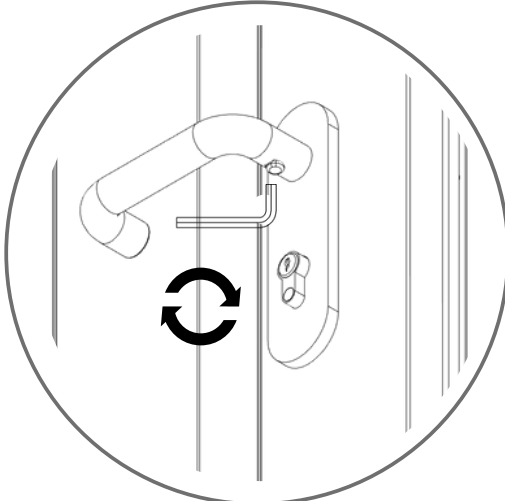
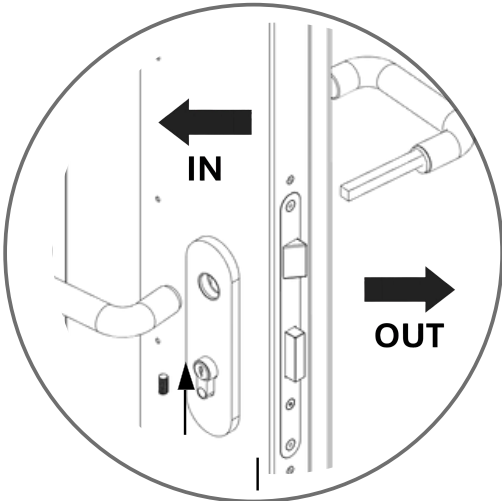
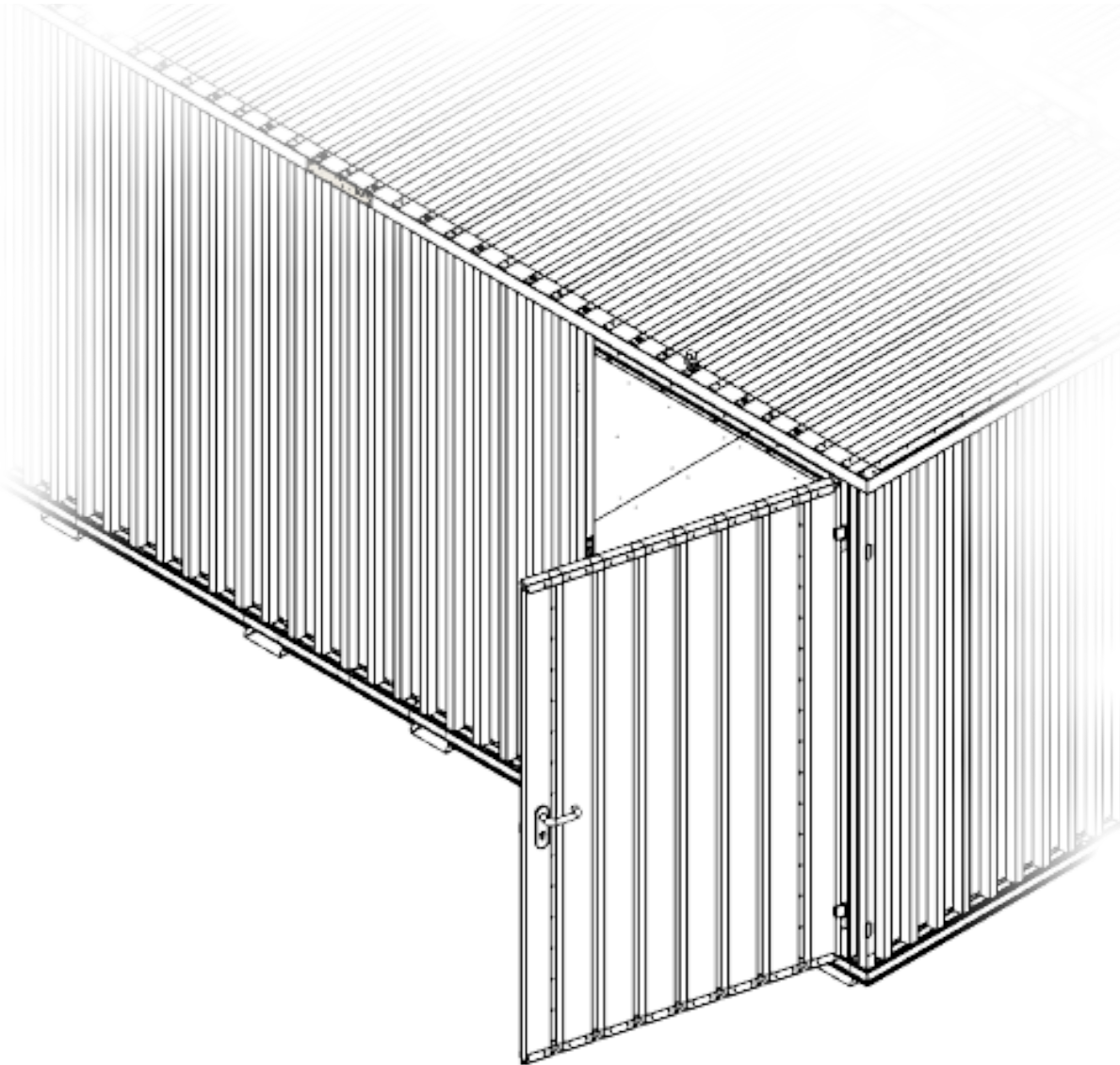

15

