

PRODUCT CODE:50.110.450

prefabase
Quick Build Solutions

Instructions and User Guide

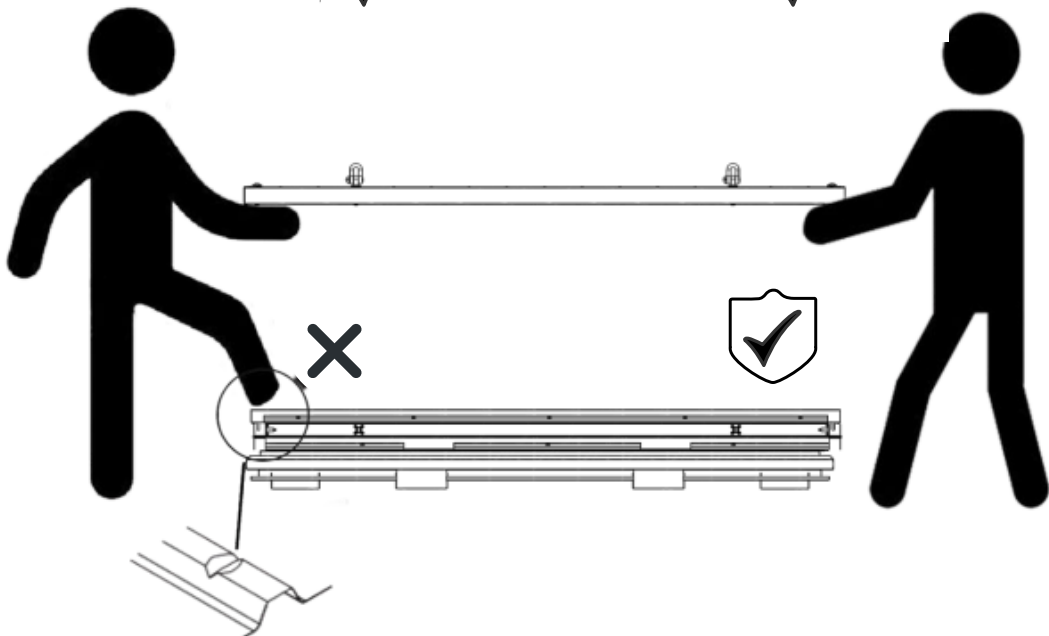
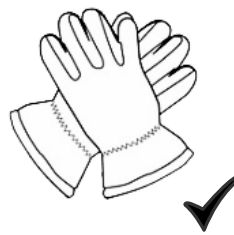

50.0110

1x

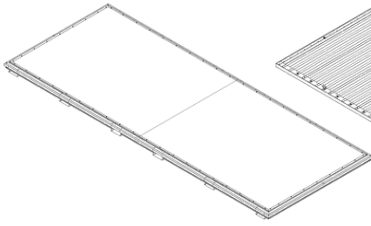

50.0510

1x

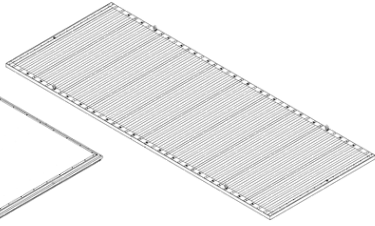

50.0410

1x

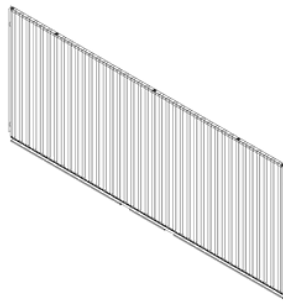

50.0450

1x

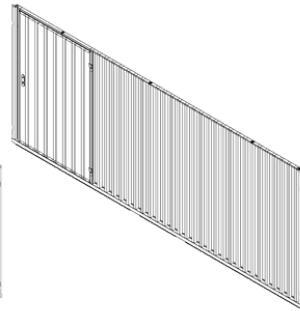

0310

2x

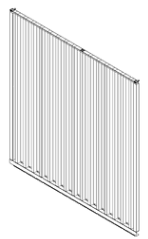

61.101

4x



12x

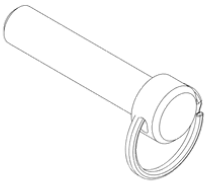

1x

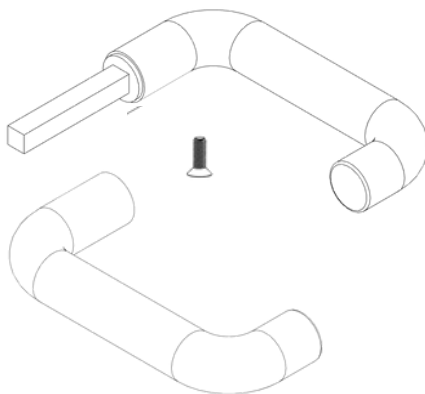

1x

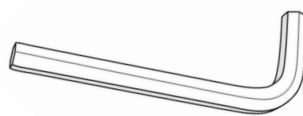

1x



1

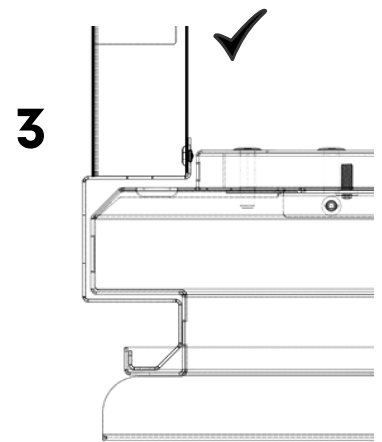
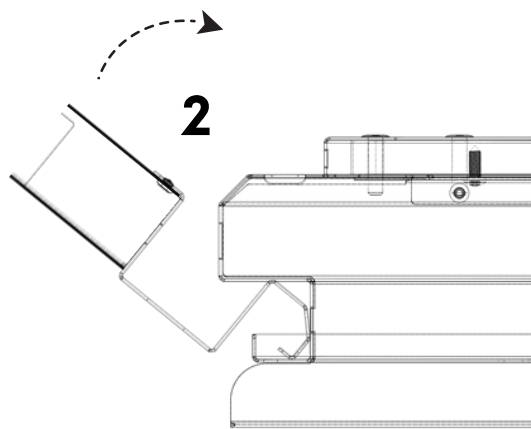
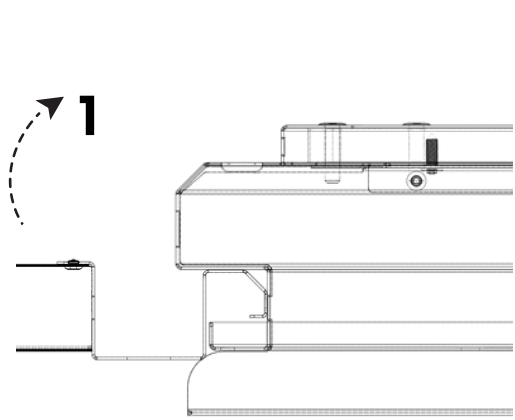
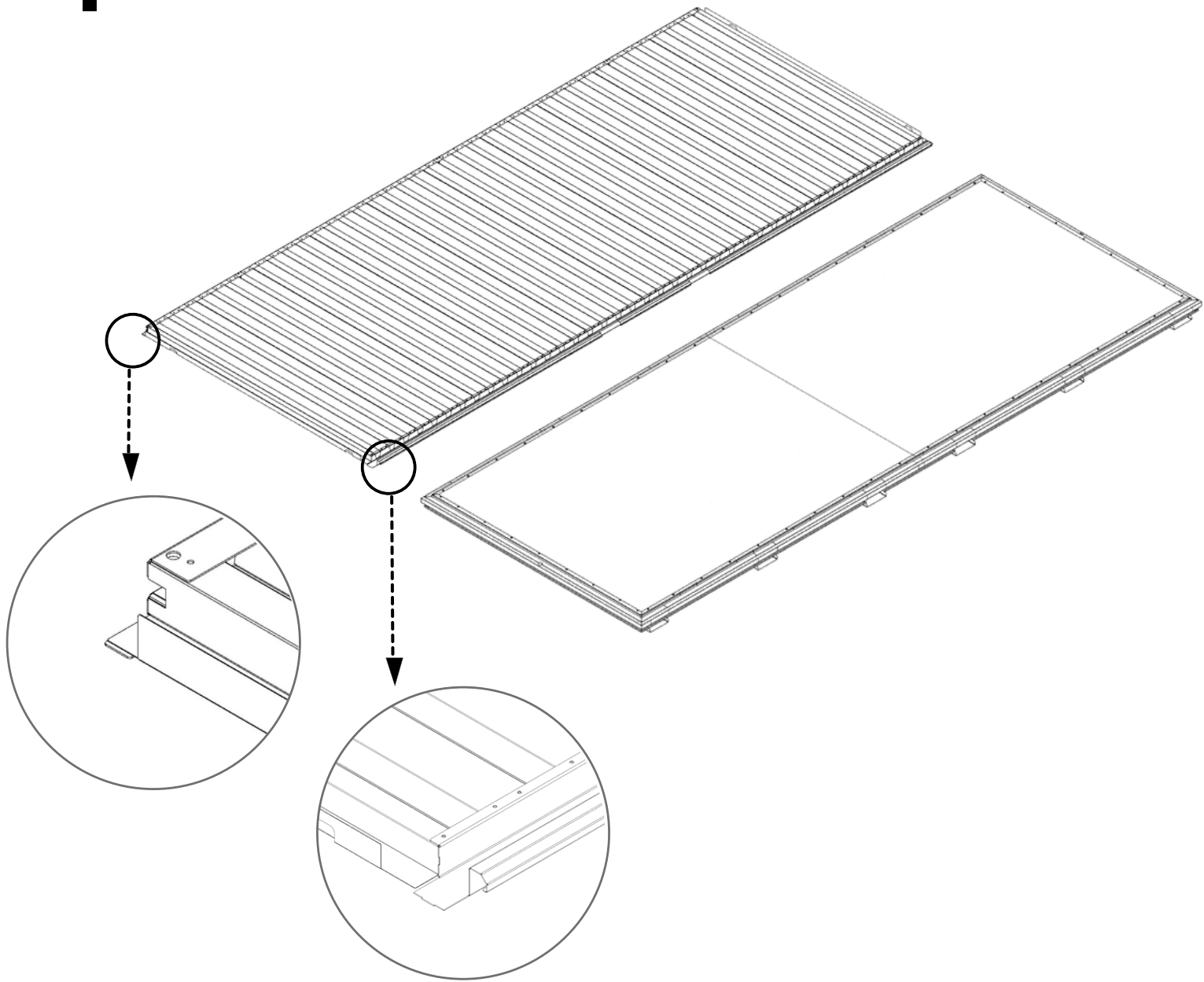

2

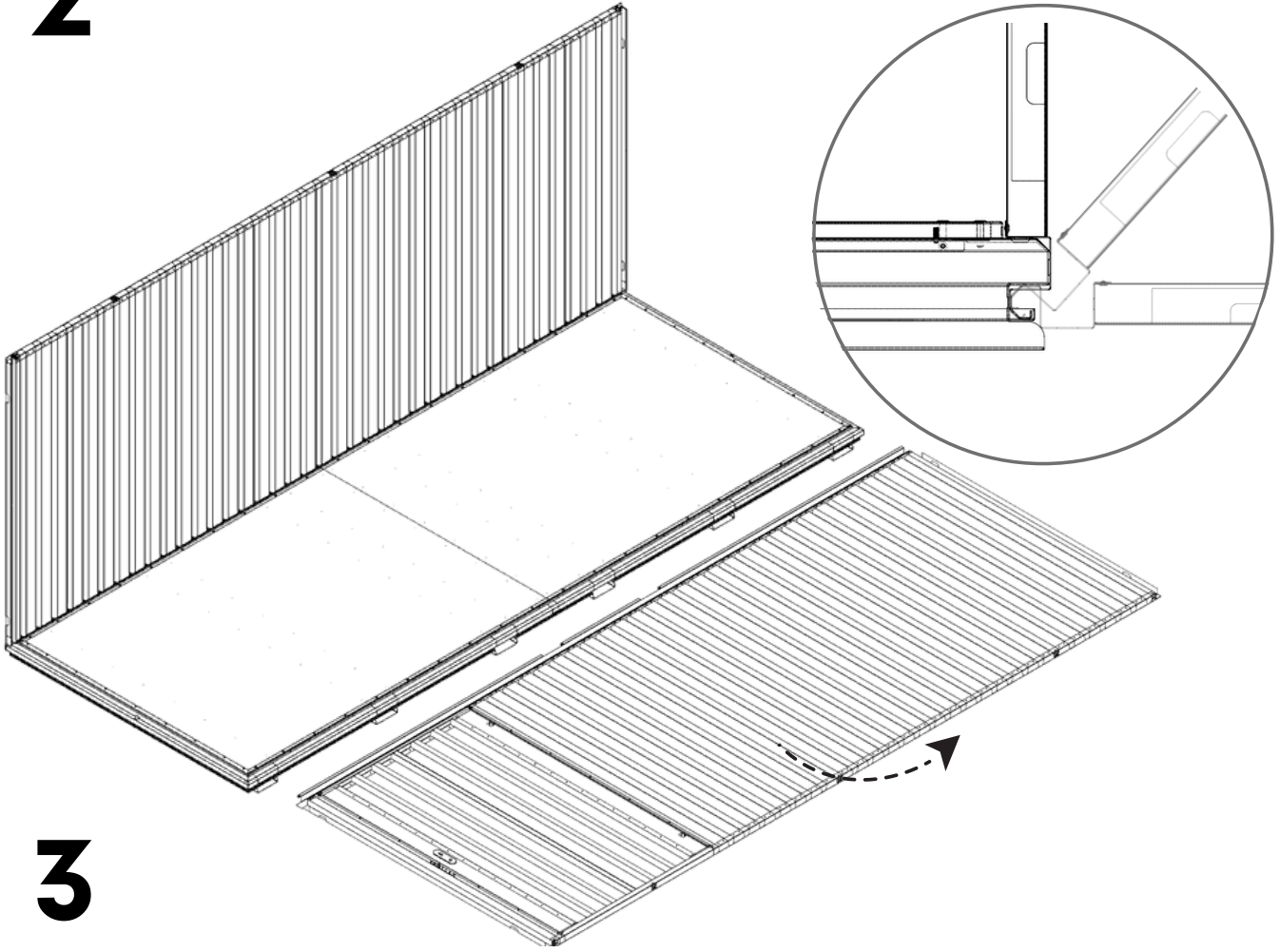

3

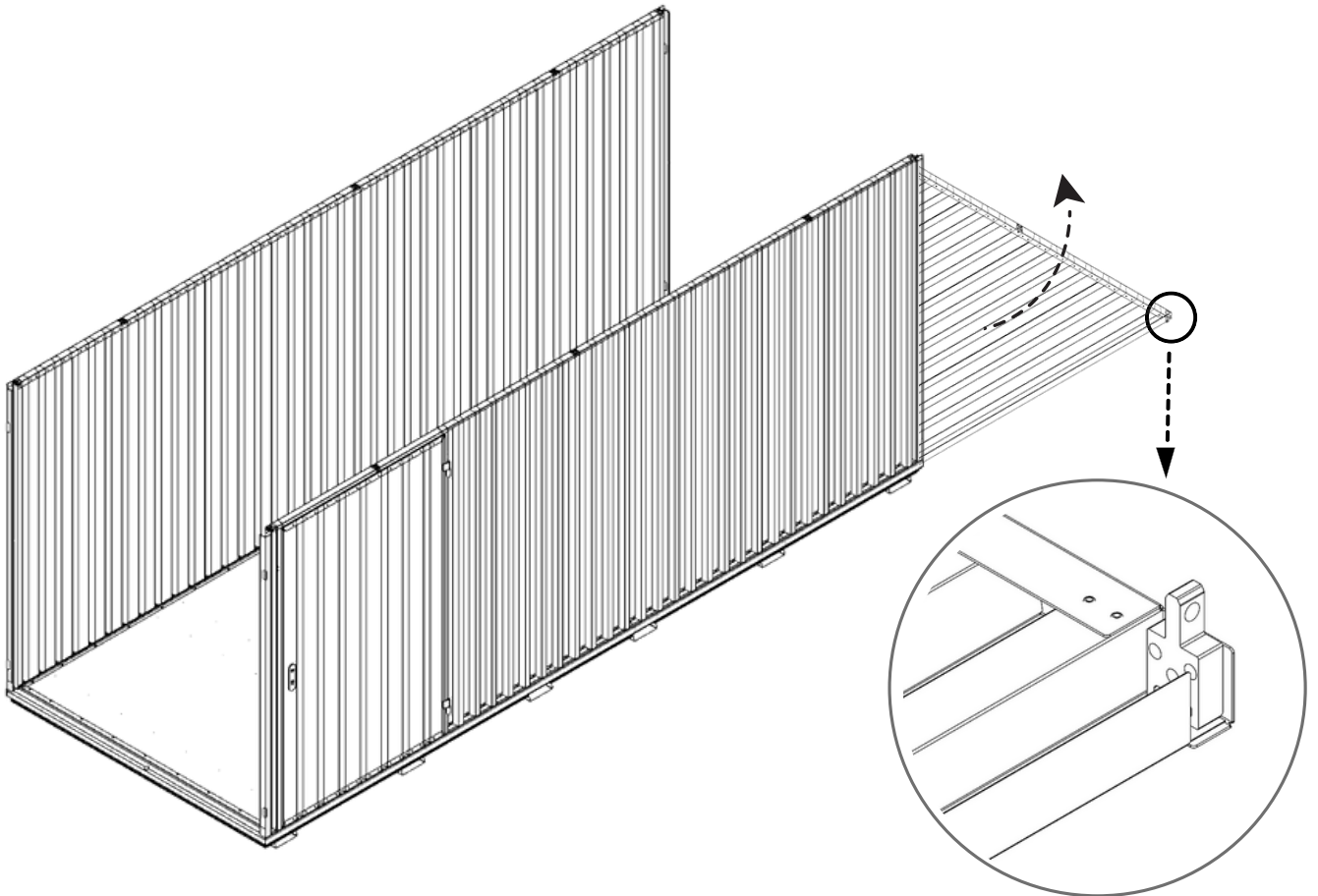

3.1

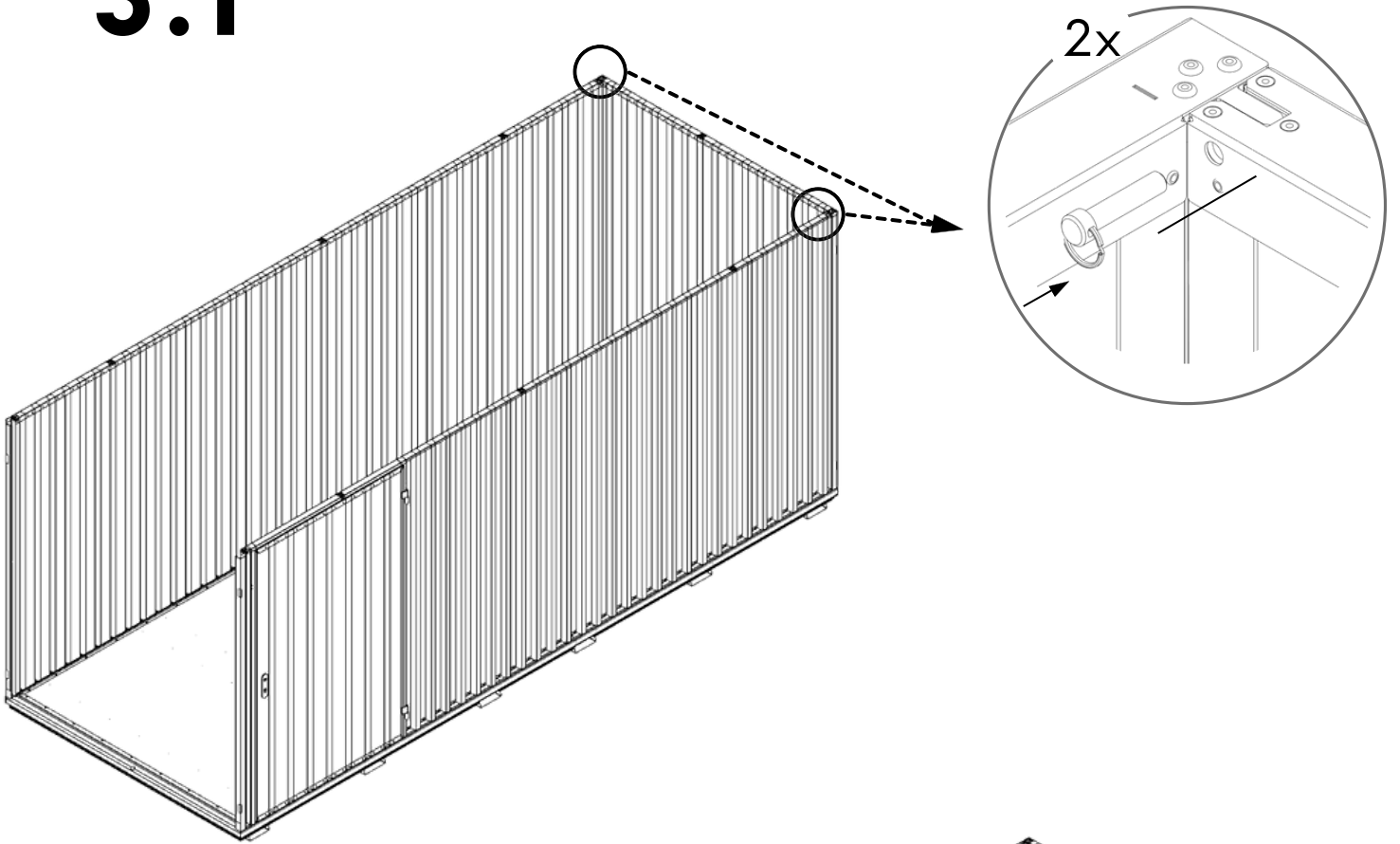



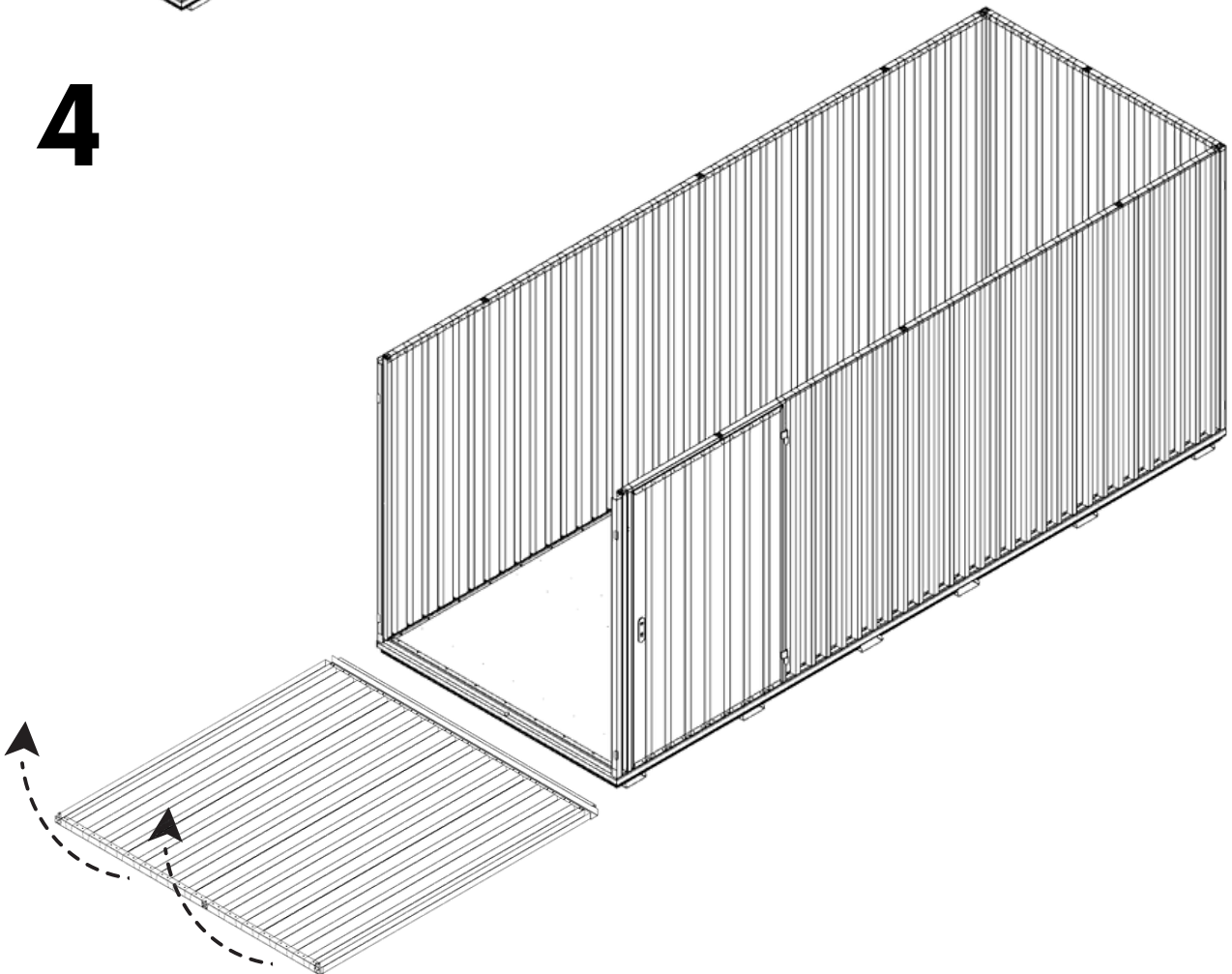



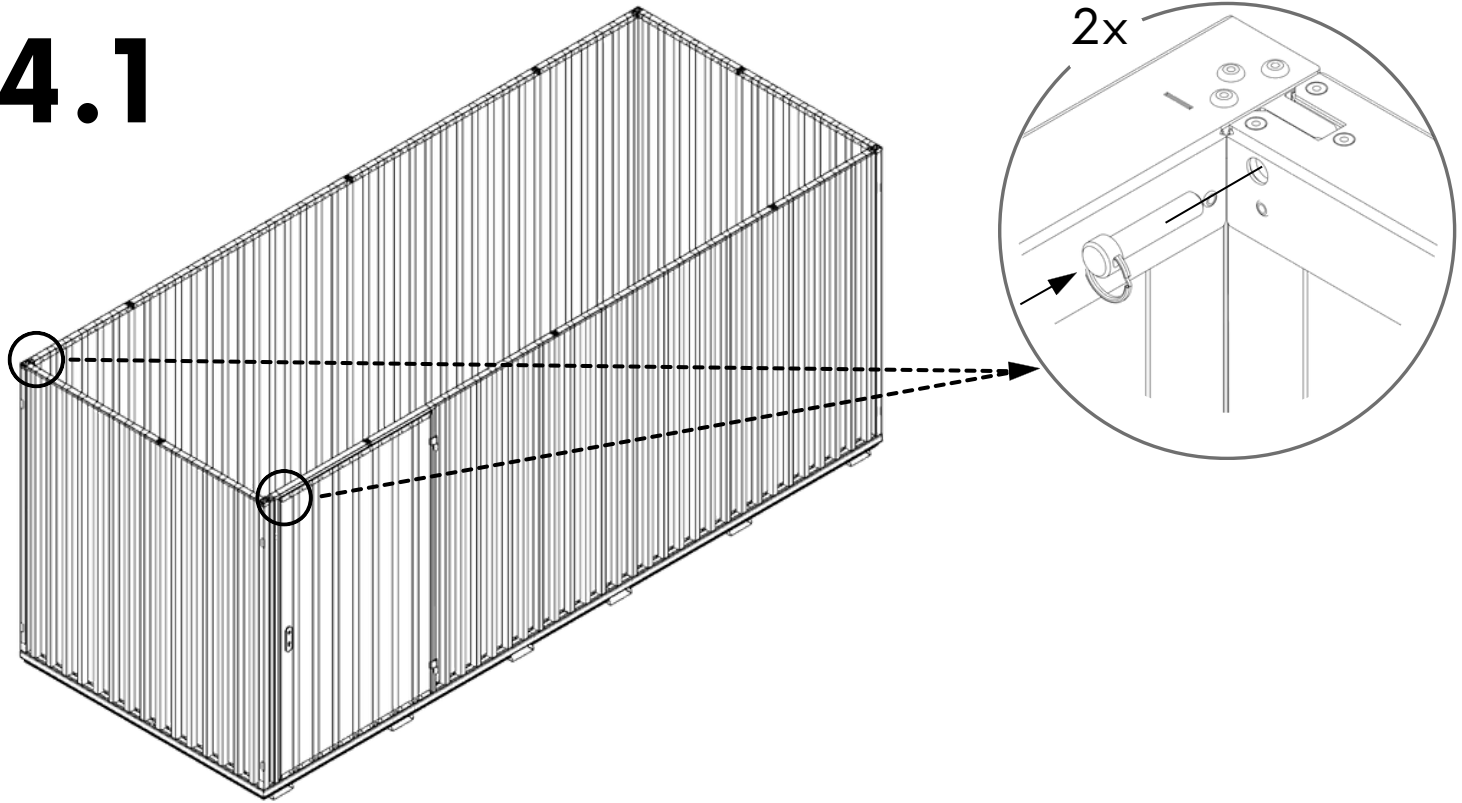

4



4.1



 492 KG	 1640 MM	Model Code: 50.110.450 Production Tracking Code: /X09.1.50.450    9001 14001 50001	 	
---	--	---	---	---

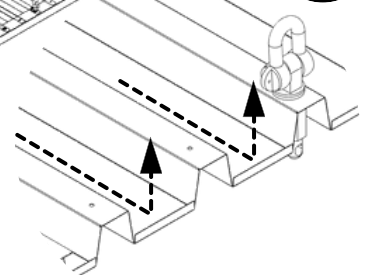
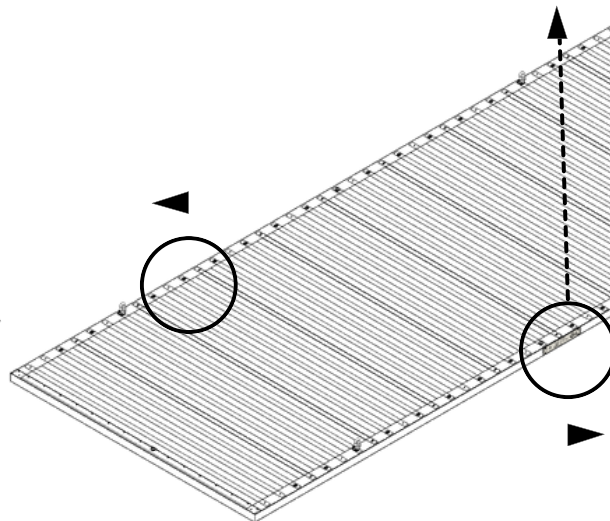
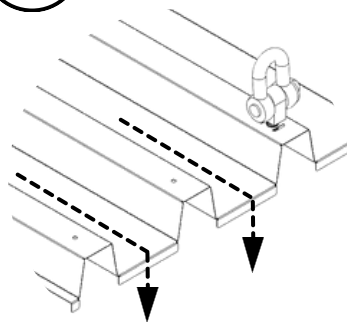

5

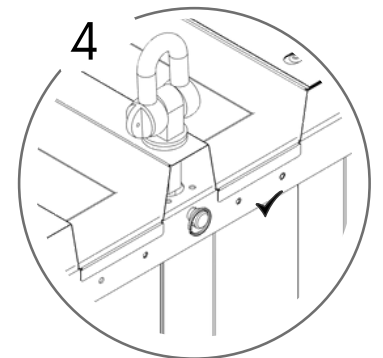
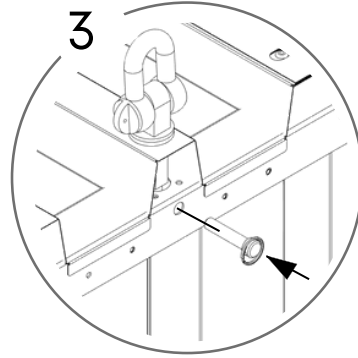
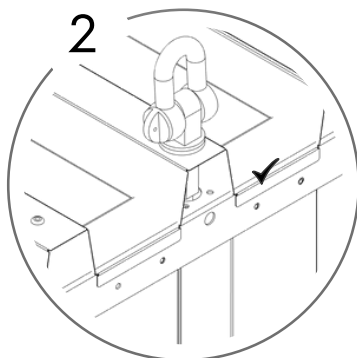
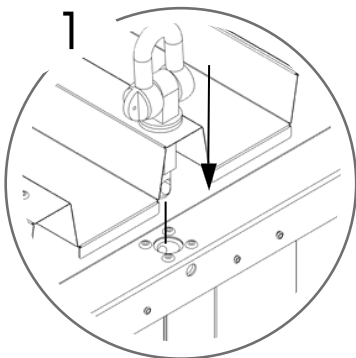
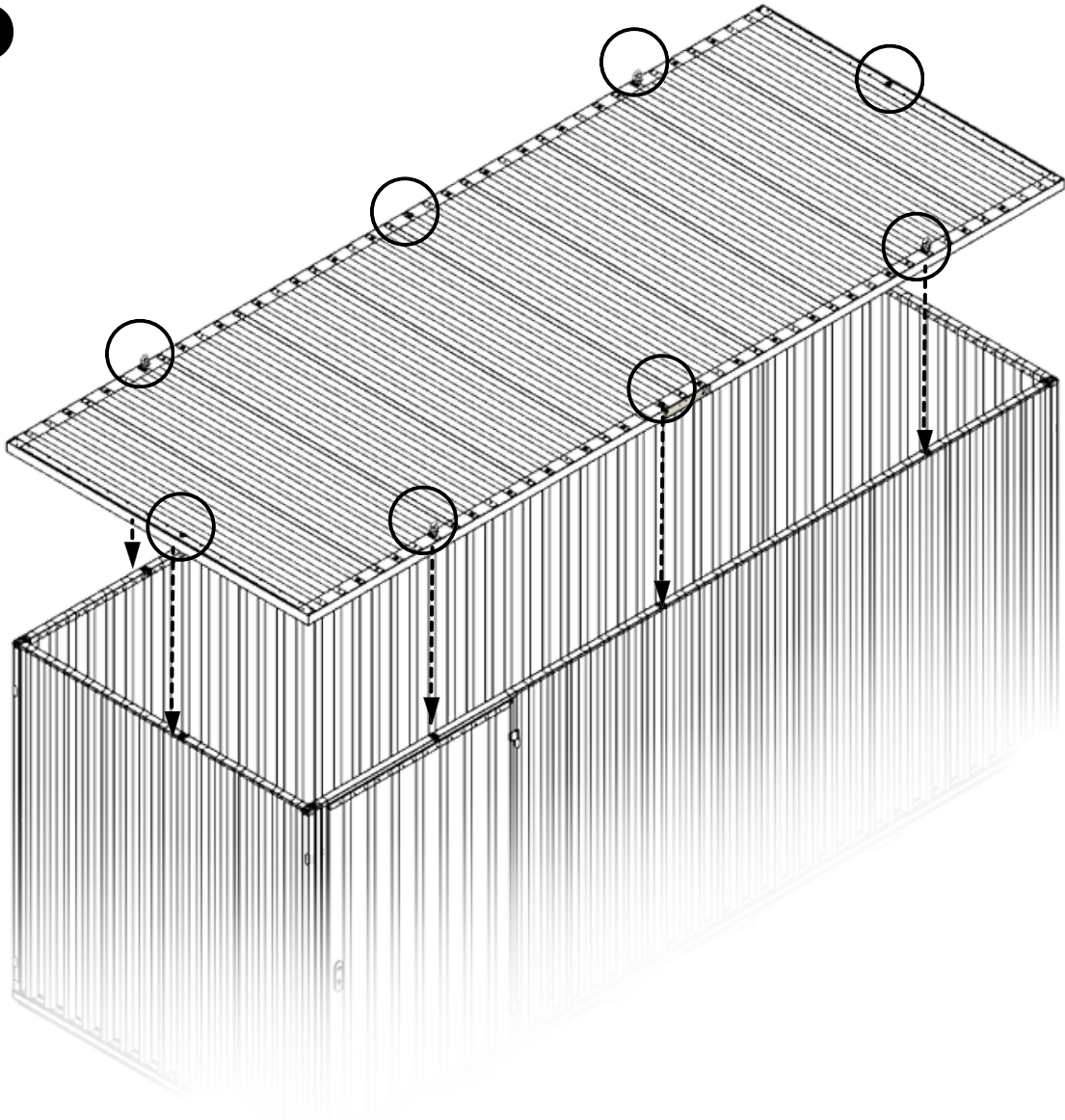

6

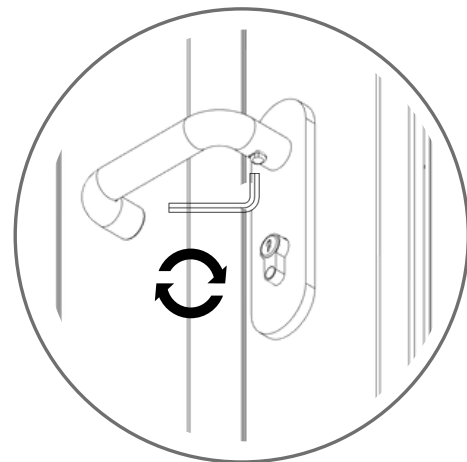
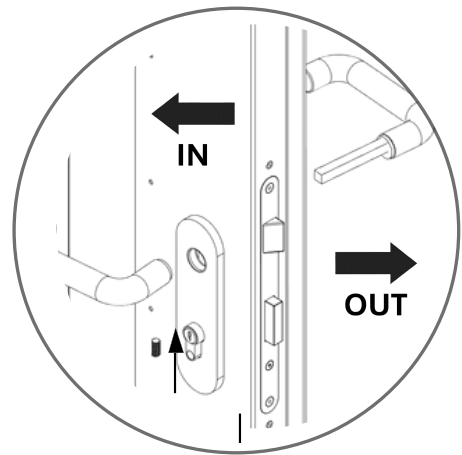
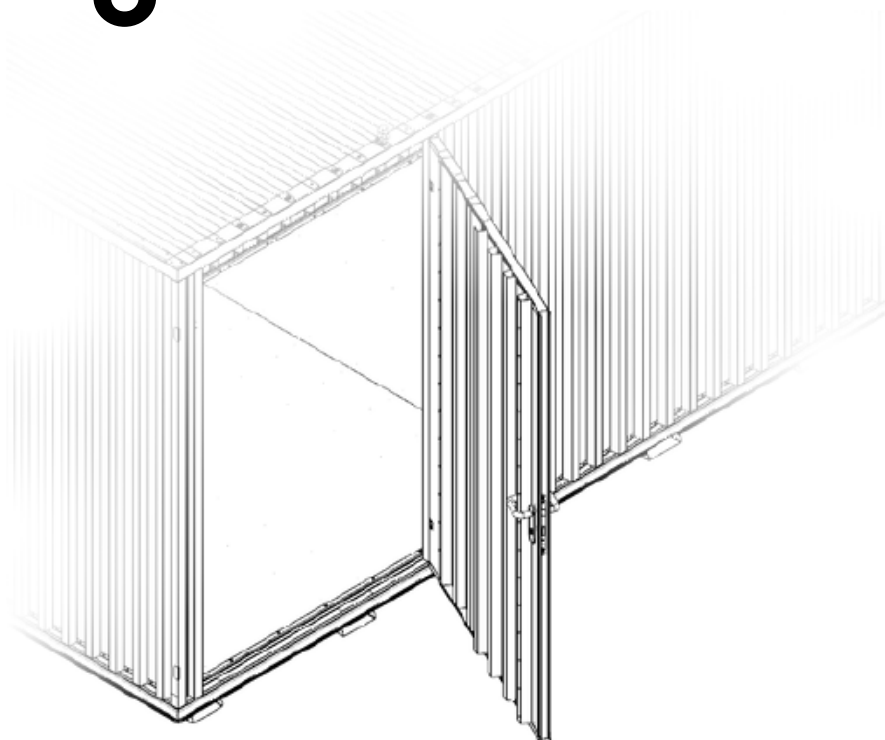

7

