

PRODUCT CODE:50.110.450.320

prefabase
Quick Build Solutions

Instructions and User Guide

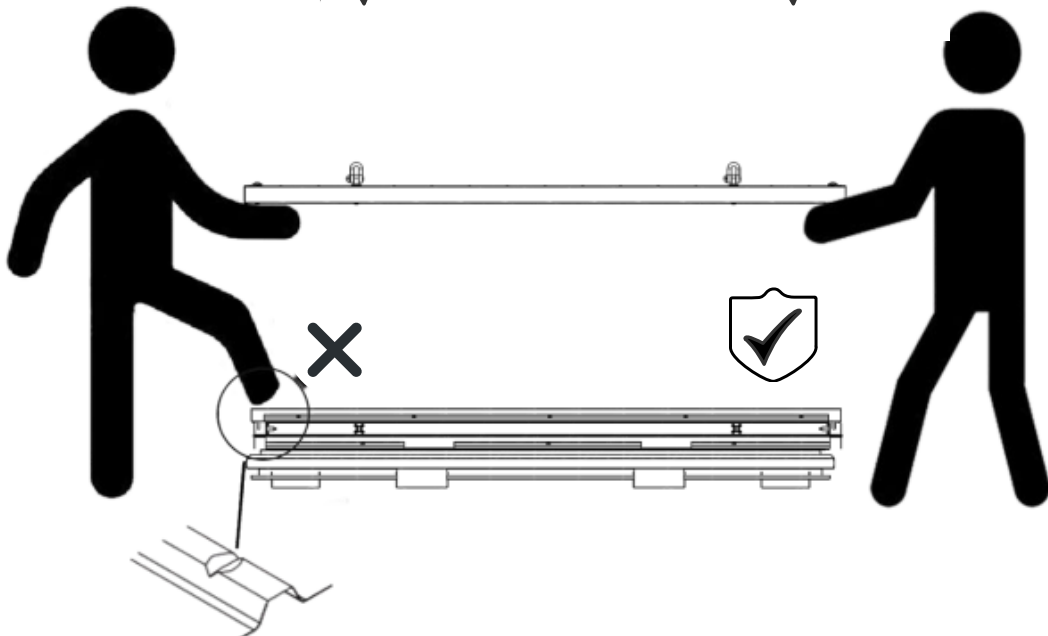
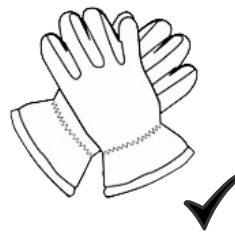
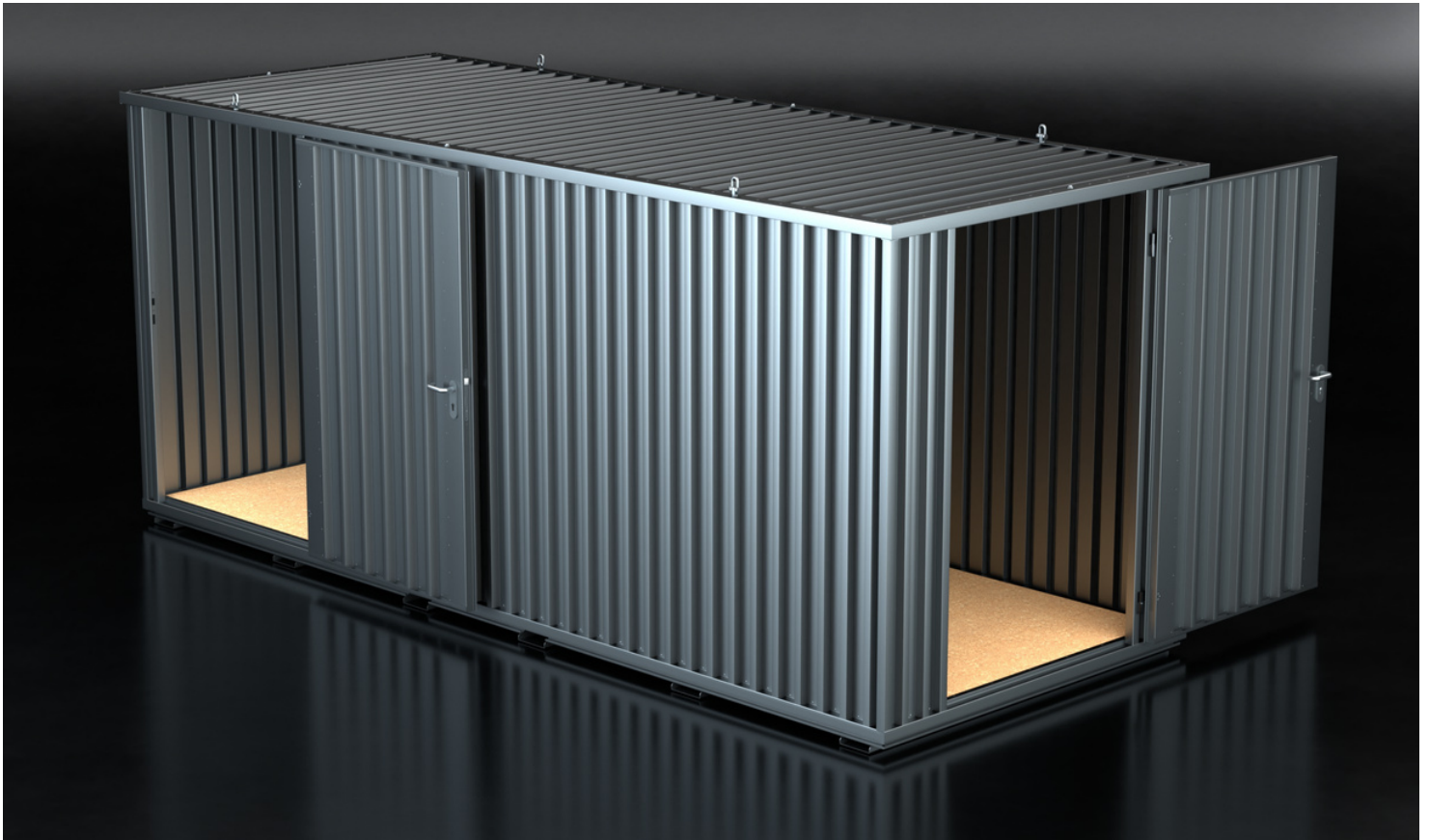

50.0110
1x

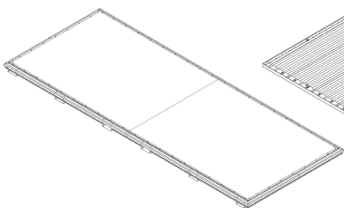

50.0510
1x

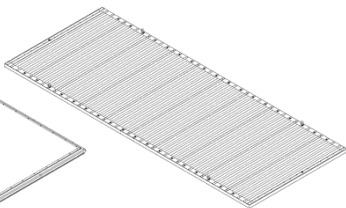

50.0410
1x

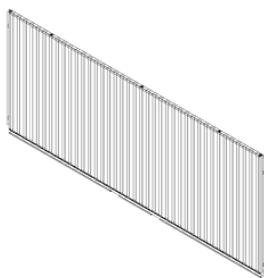

50.0450
1x

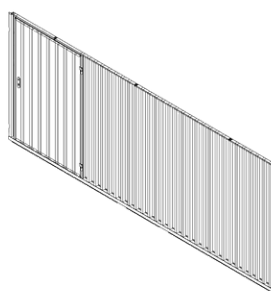

0310
1x

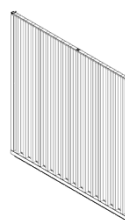

0320
1x



61.101
4x

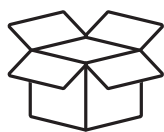

12x

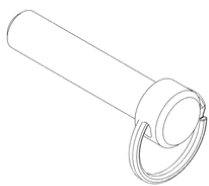

2x

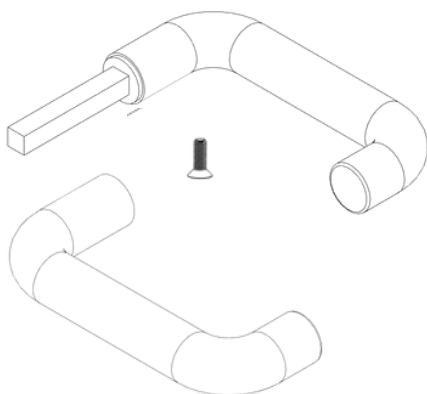

1x

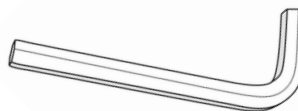

2x



1

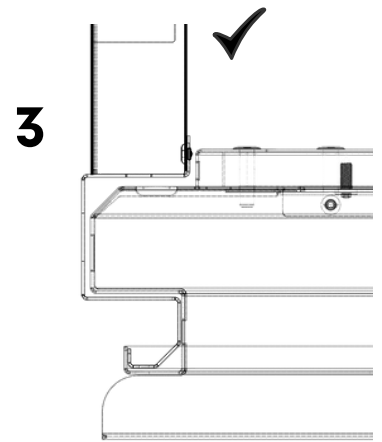
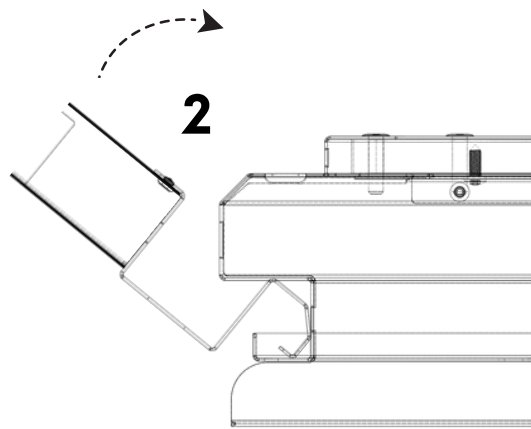
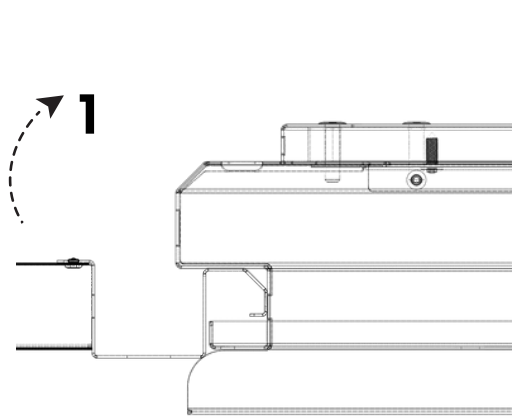
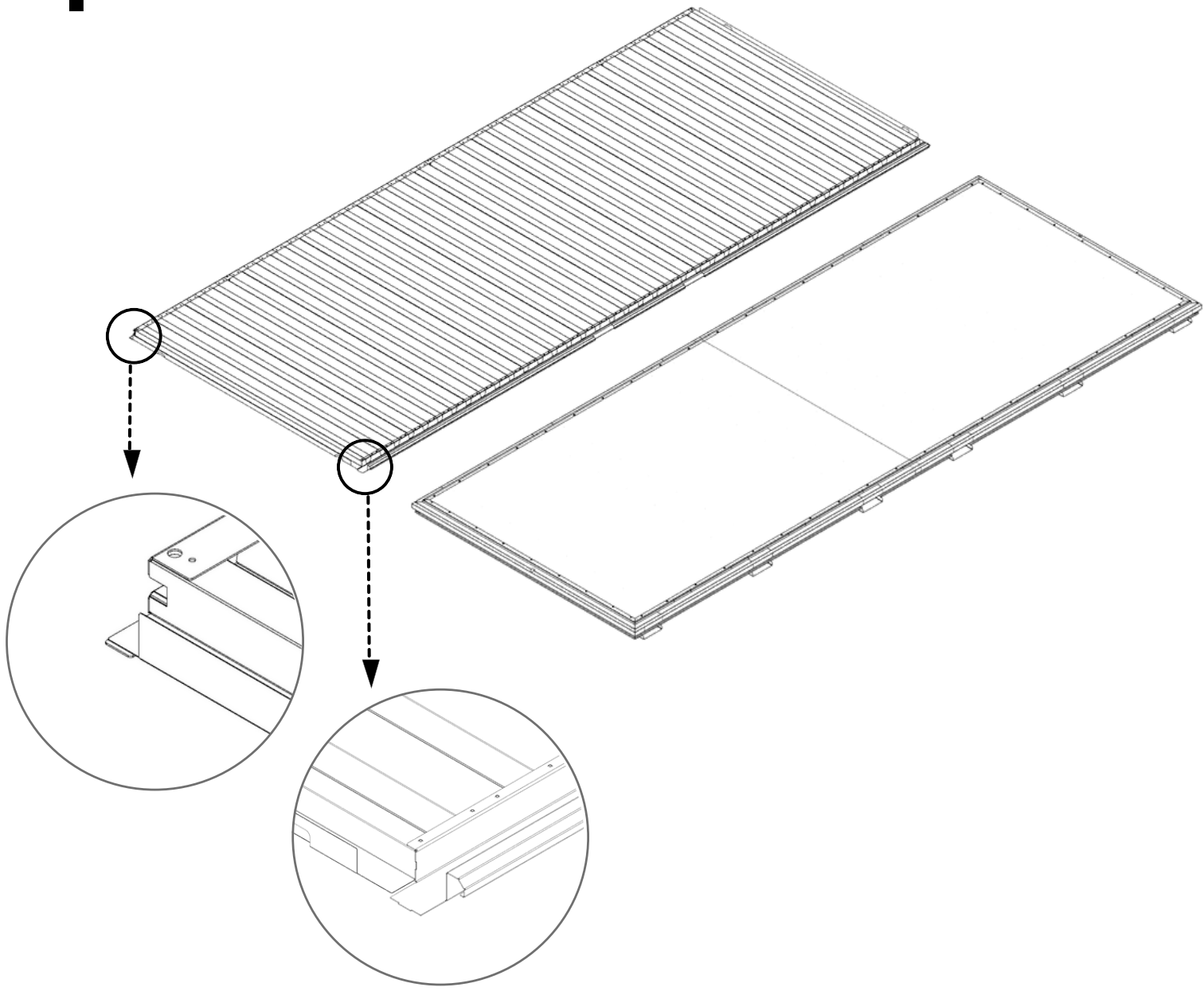

2

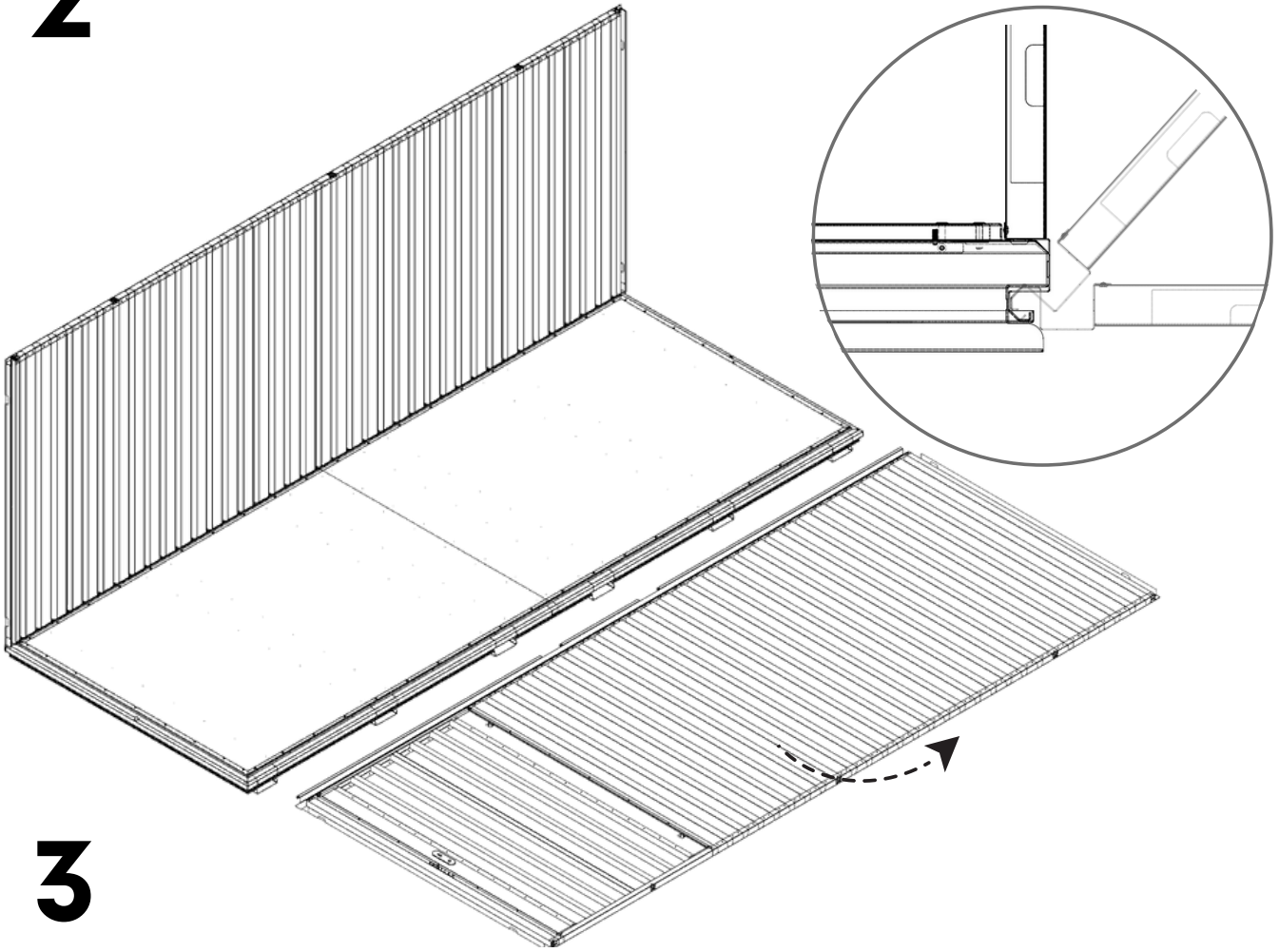

3

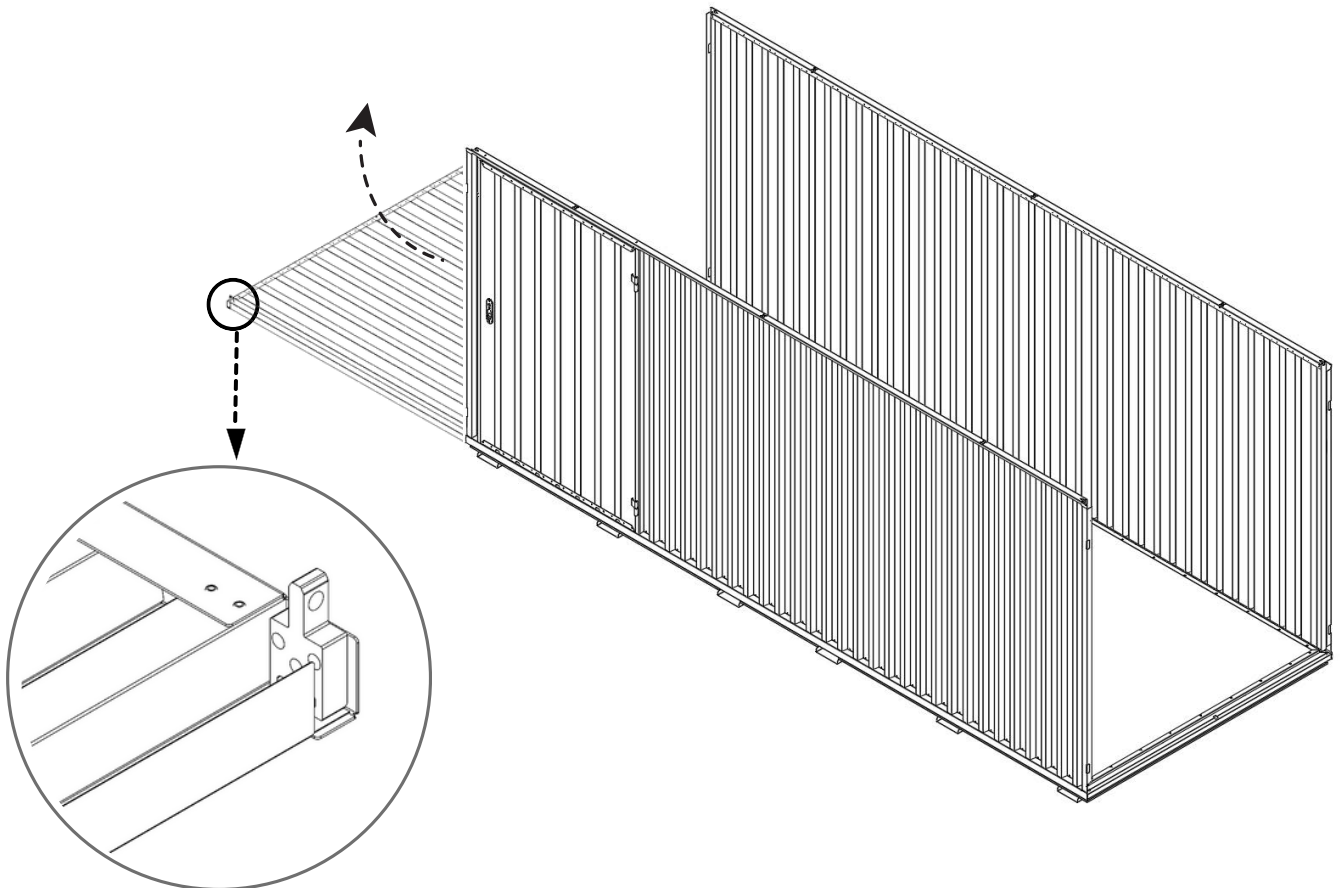

3.1

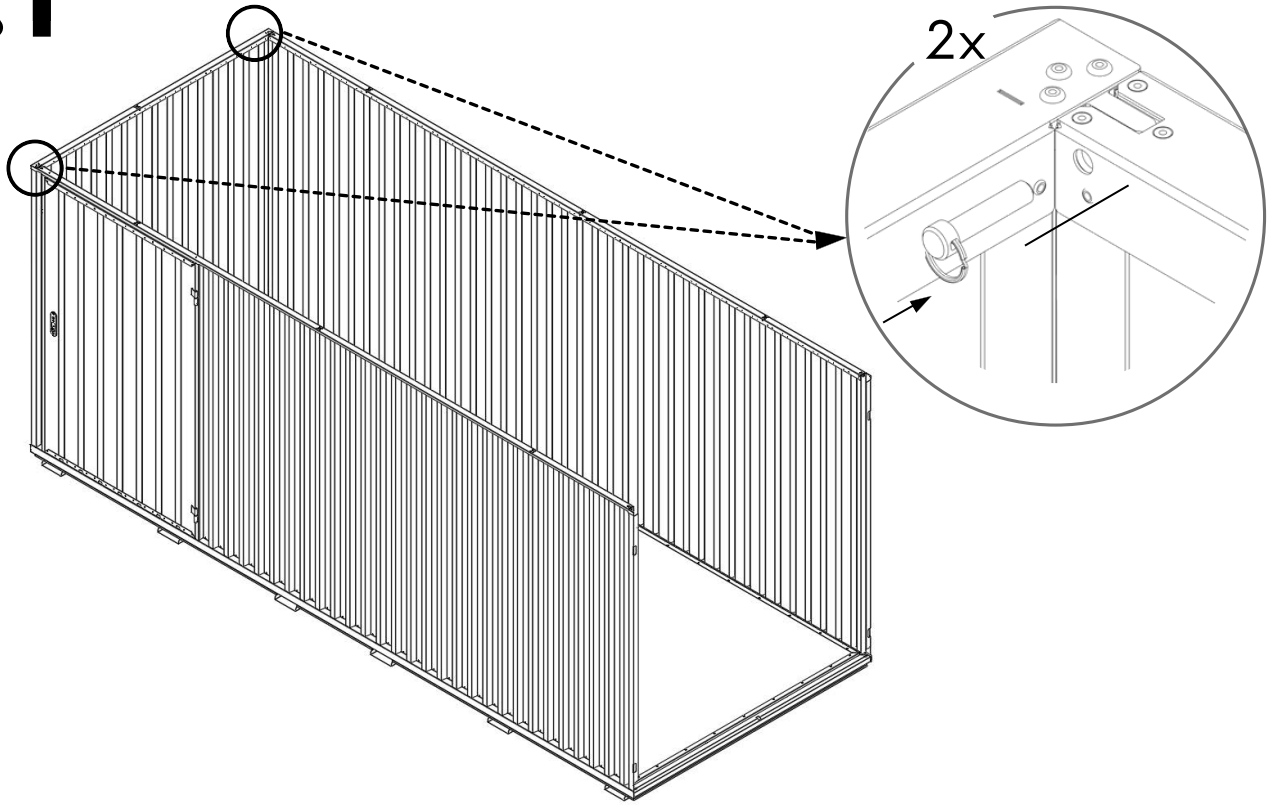



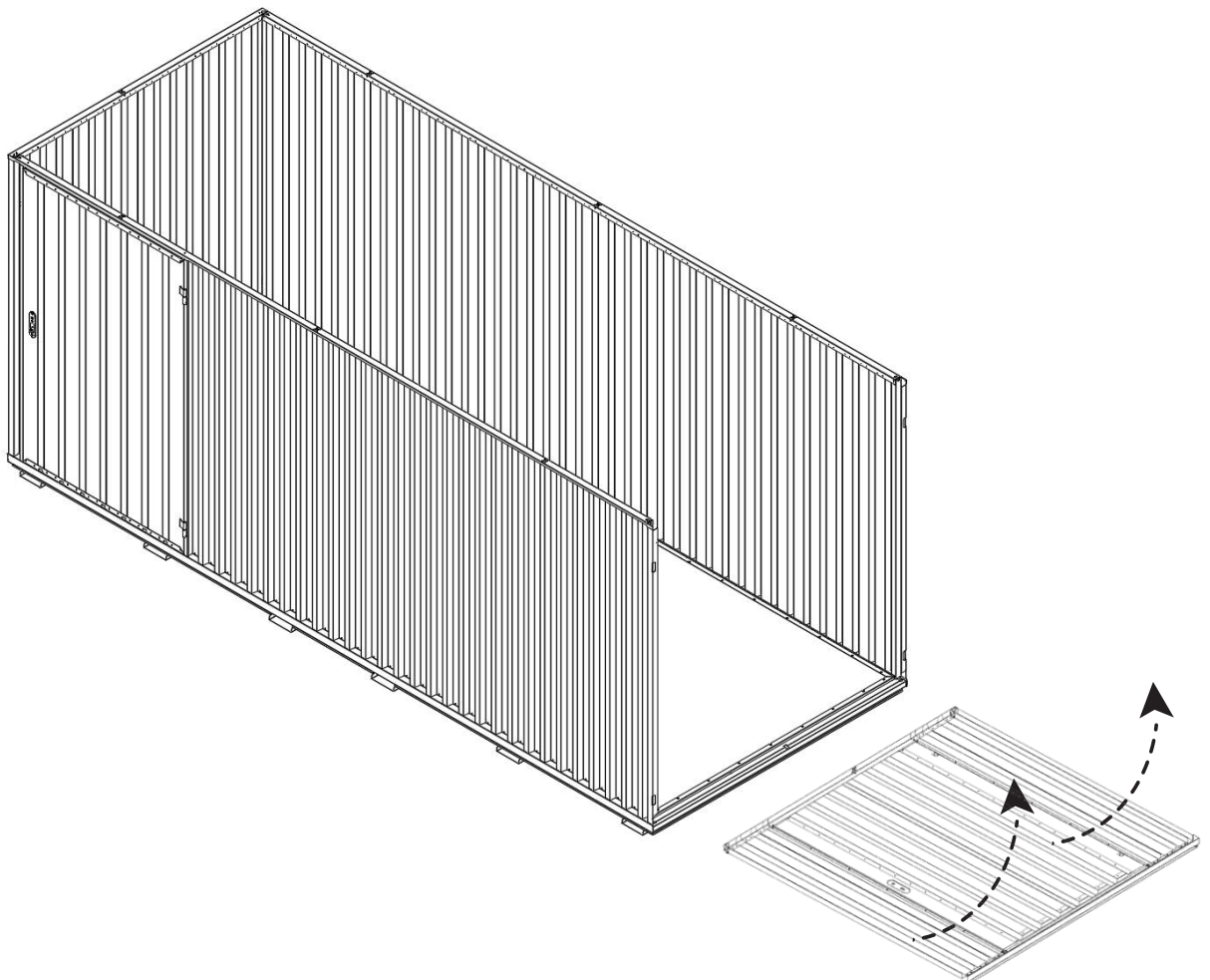



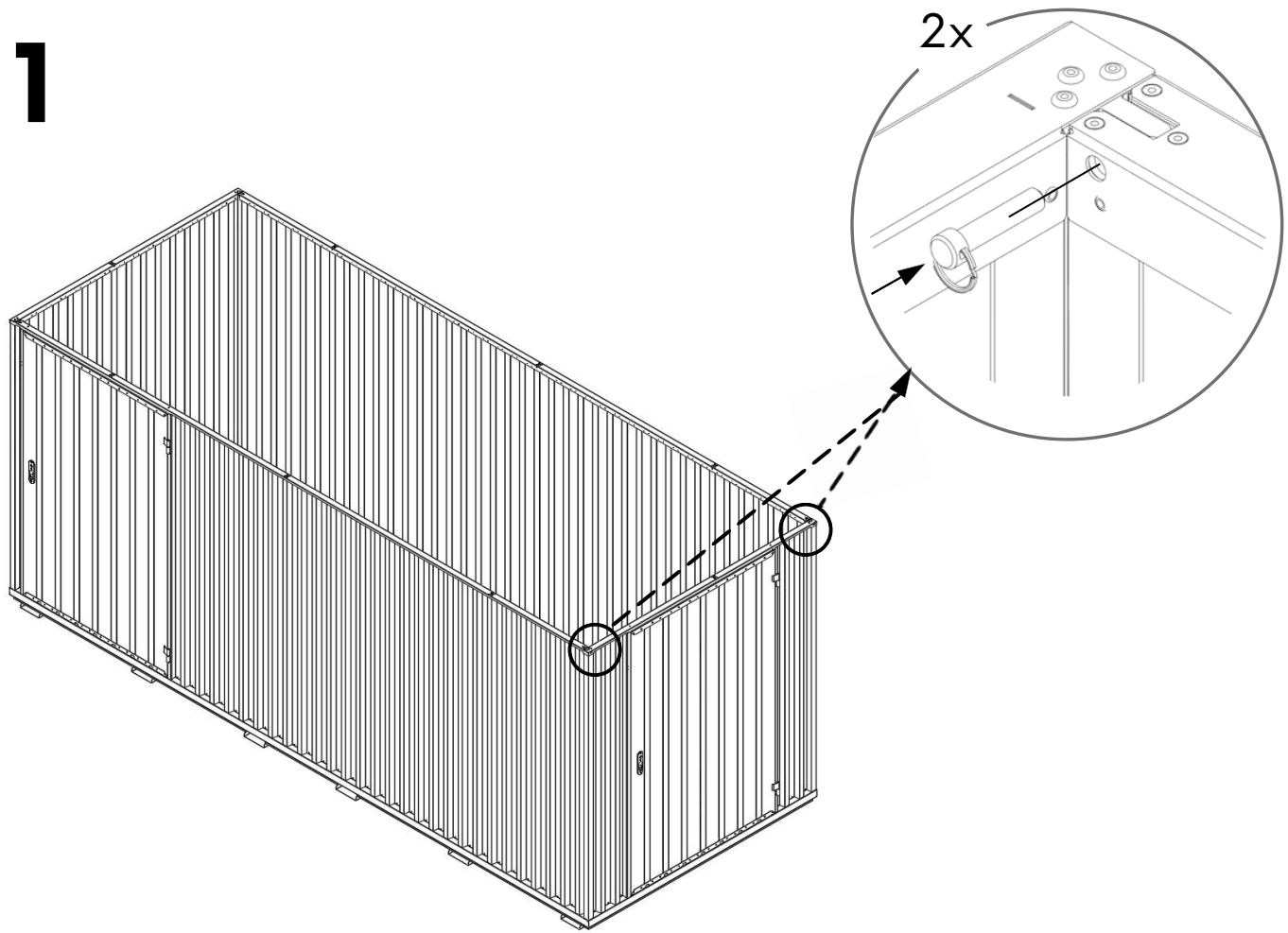

4



4.1



 508 KG	 1640 MM	Model Code: 50.110.450.320 Production Tracking Code:/X09.1.50.450.320    9001 14001 50001	 	
---	--	--	---	---

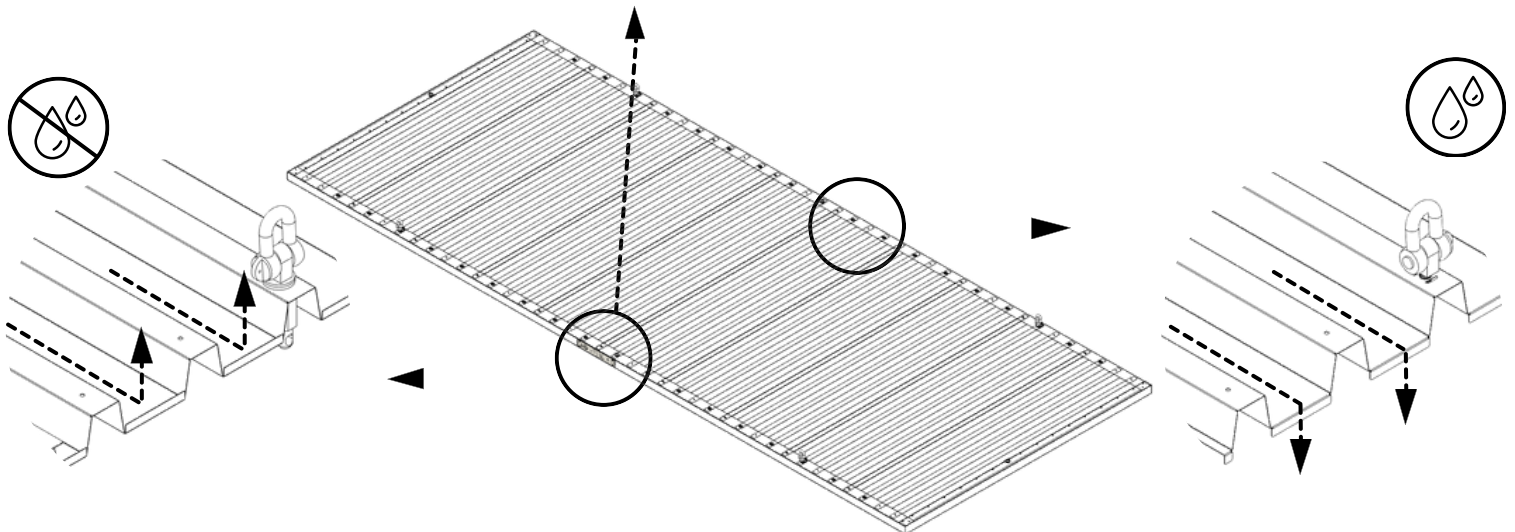

5

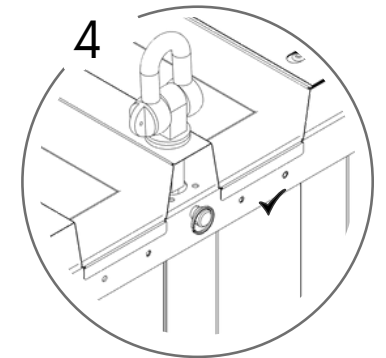
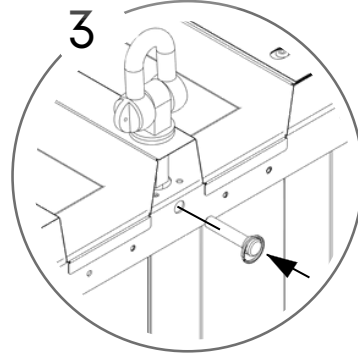
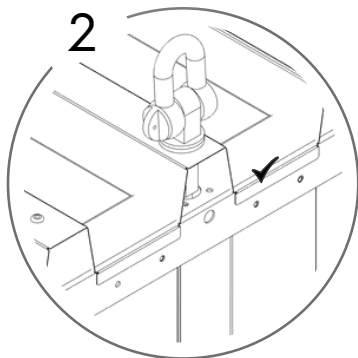
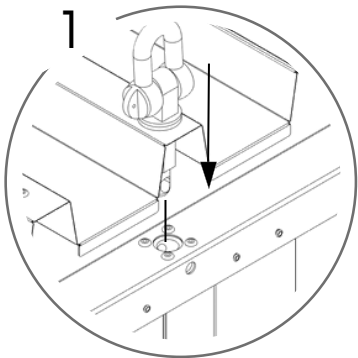
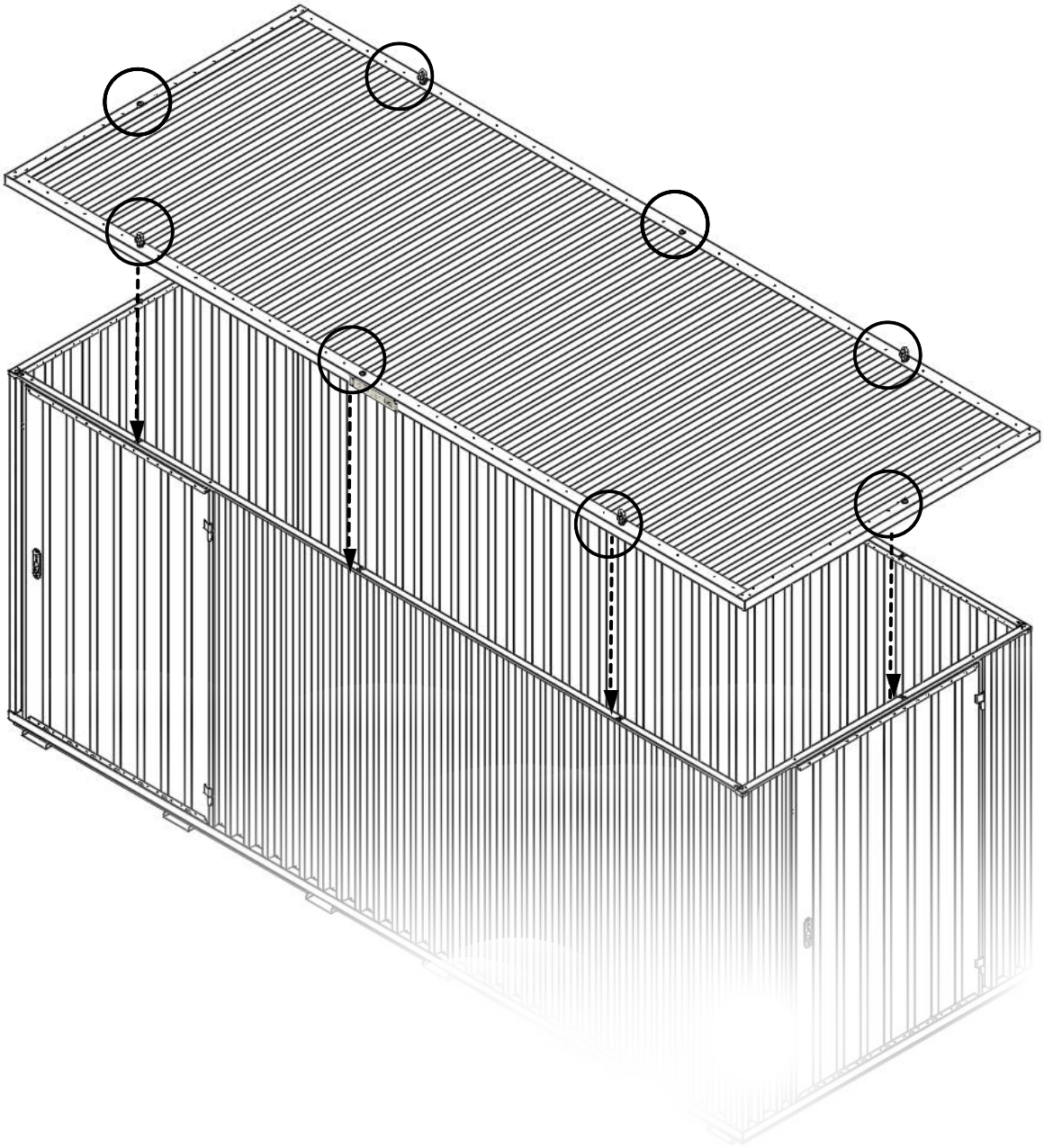

6

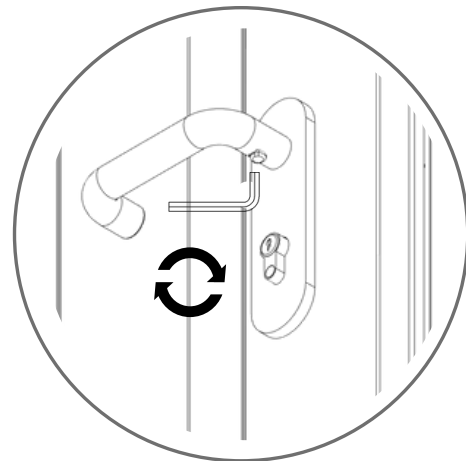
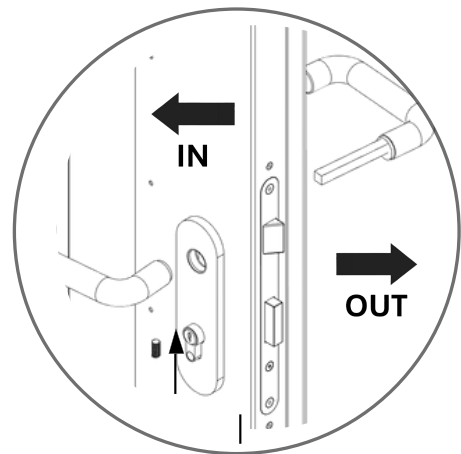
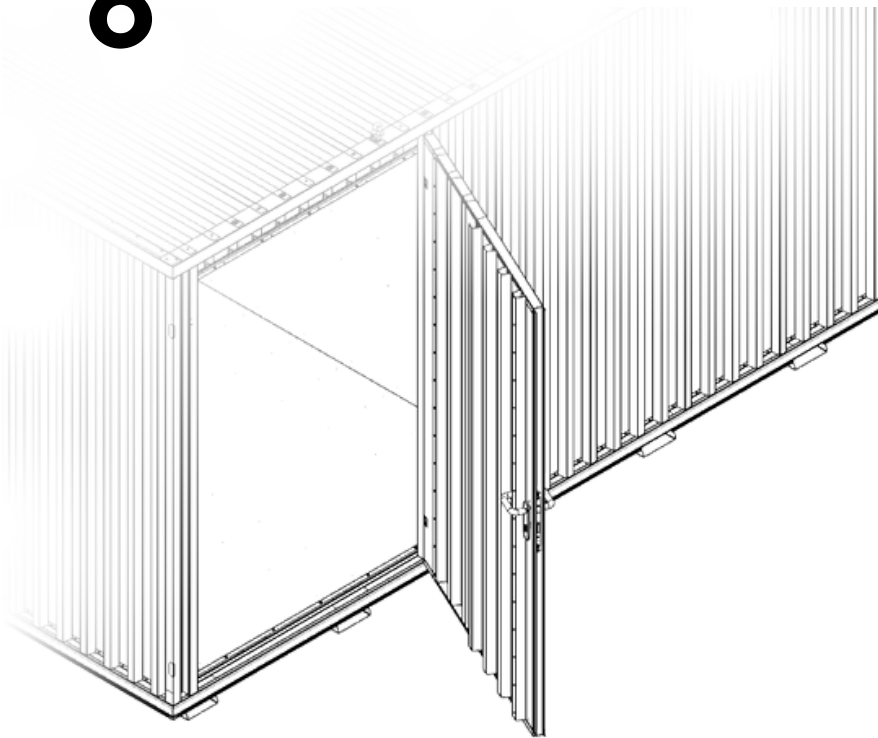

7

