

PRODUCT CODE:6050.110.450.330

prefabase
Quick Build Solutions

Instructions and User Guide

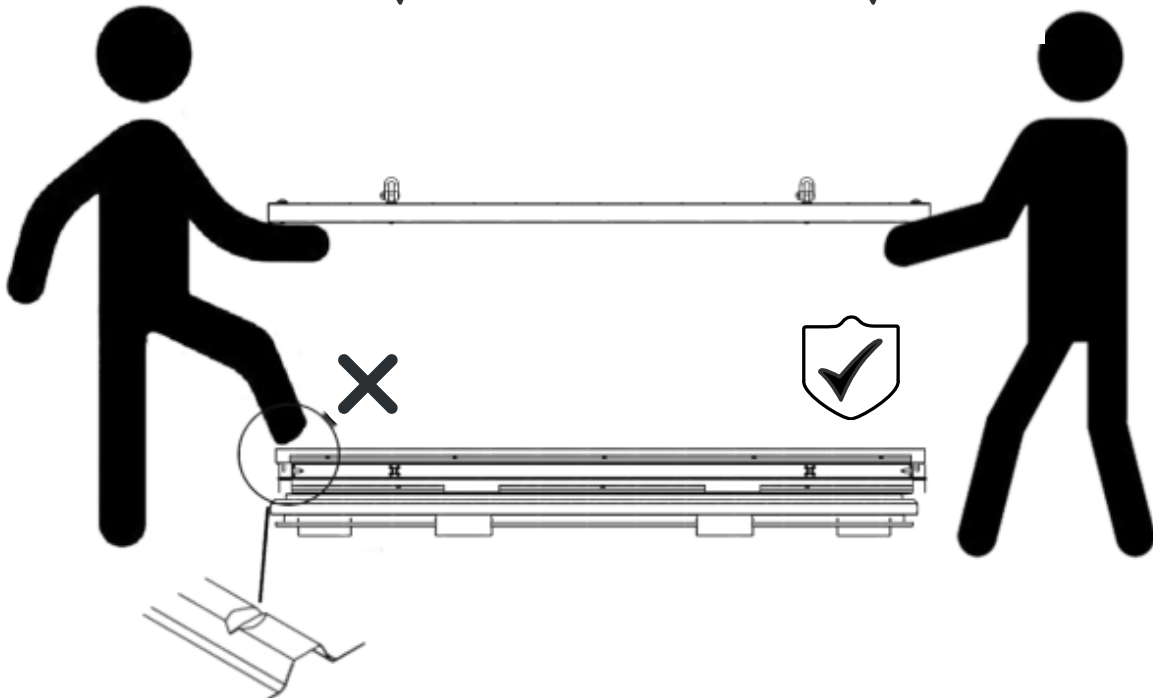
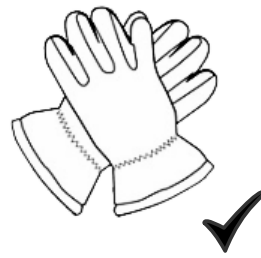
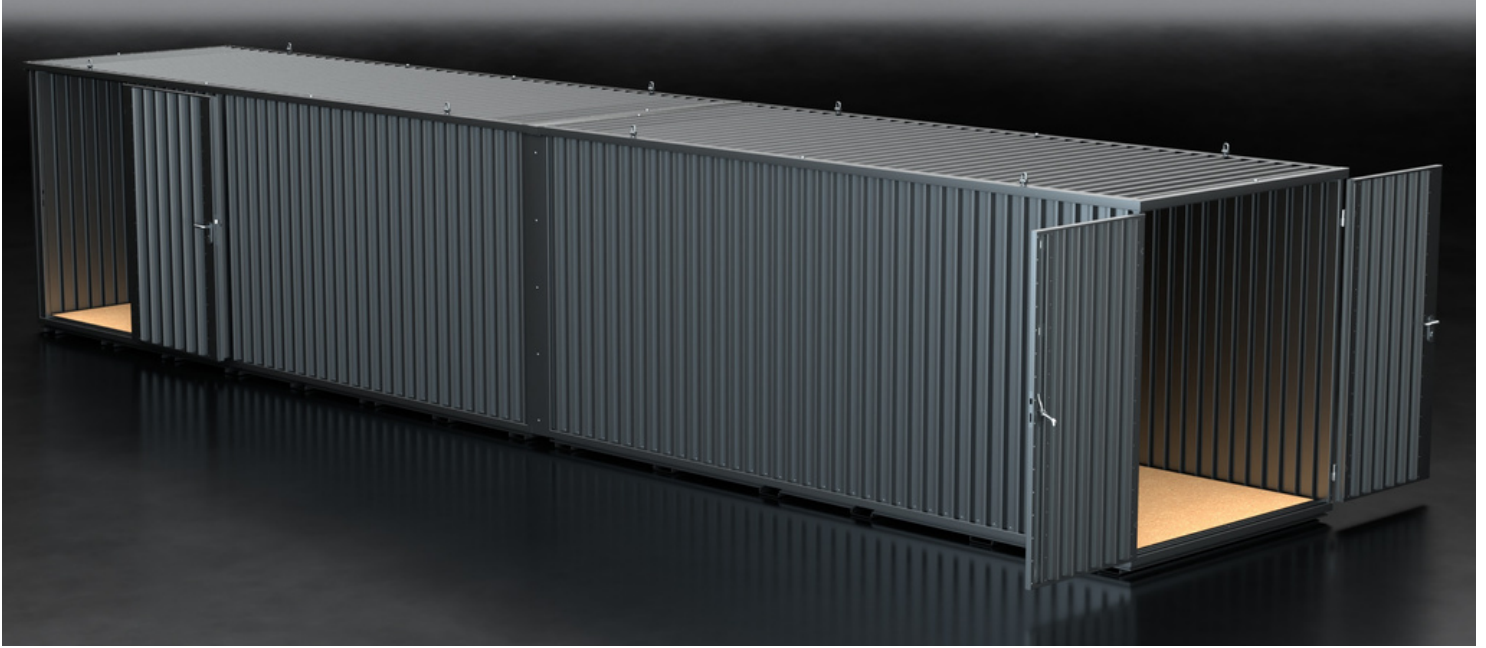

60.0110

1x

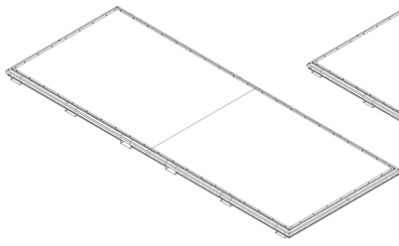

50.0110

1x

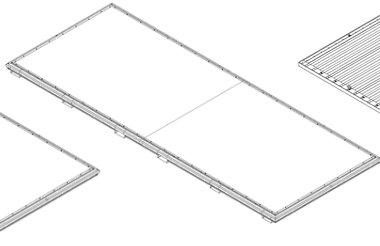

60.0510

1x

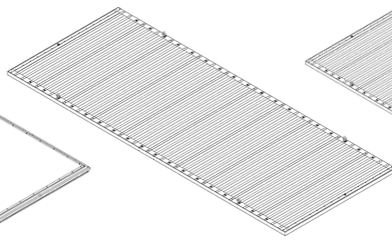

50.0510

1x

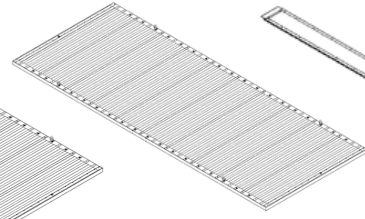

306.0110

1x



306.0510

1x



60.0410

2x

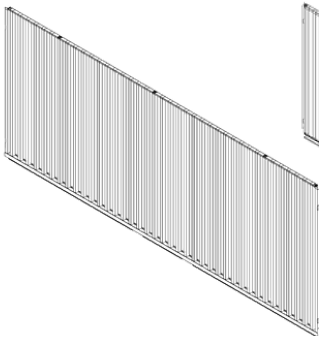

50.0410

1x

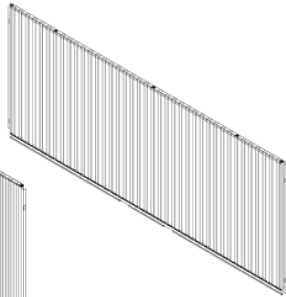

50.0450

1x

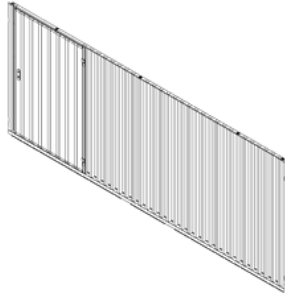

0310

1x

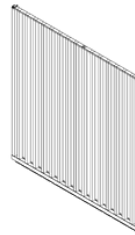

0330

1x



306.40.05

2x



306.40.04

2x



61.101

2x



26x



2x

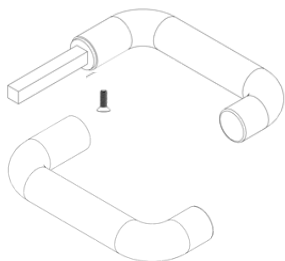

10x



10x



10x



1x



2x



1

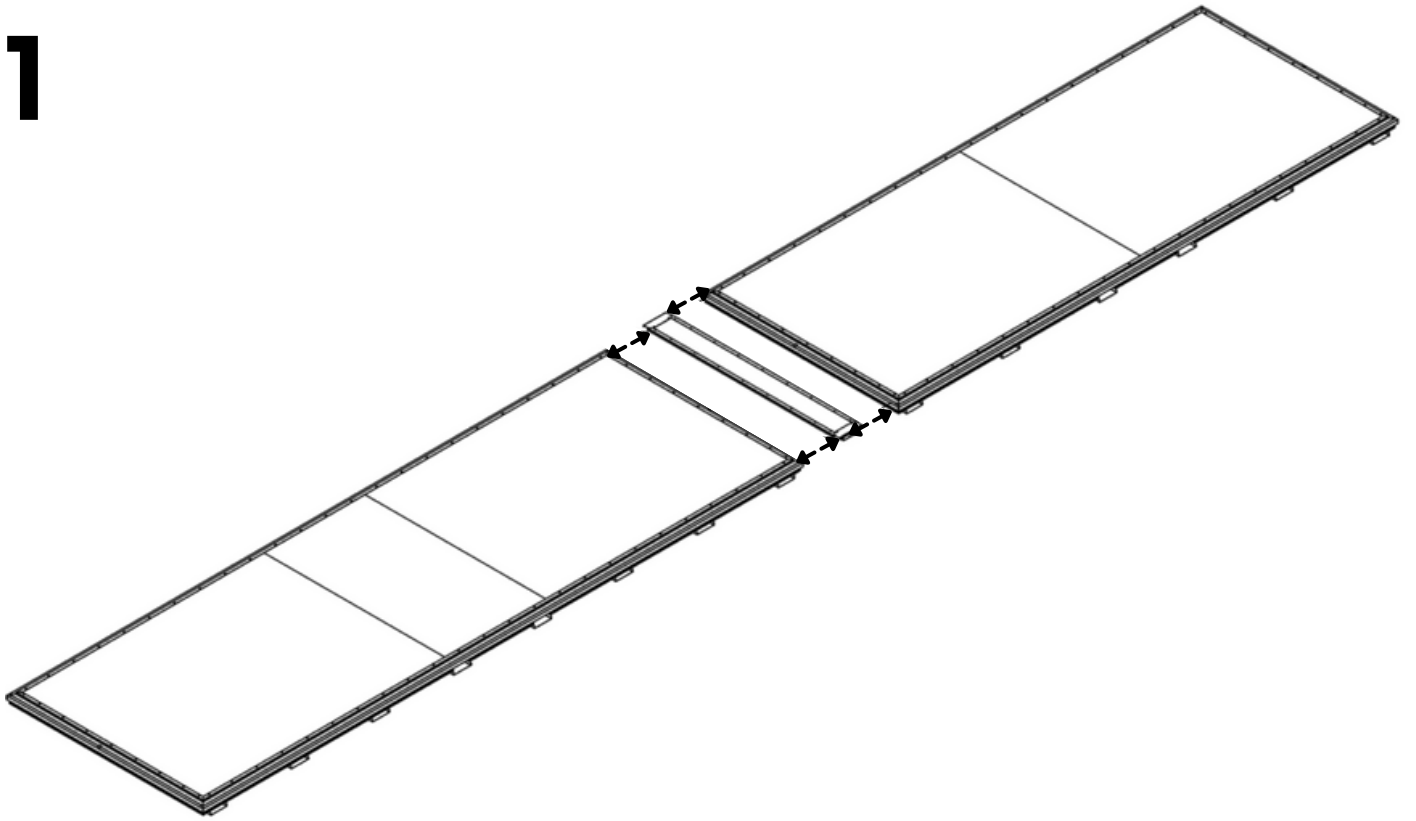

2

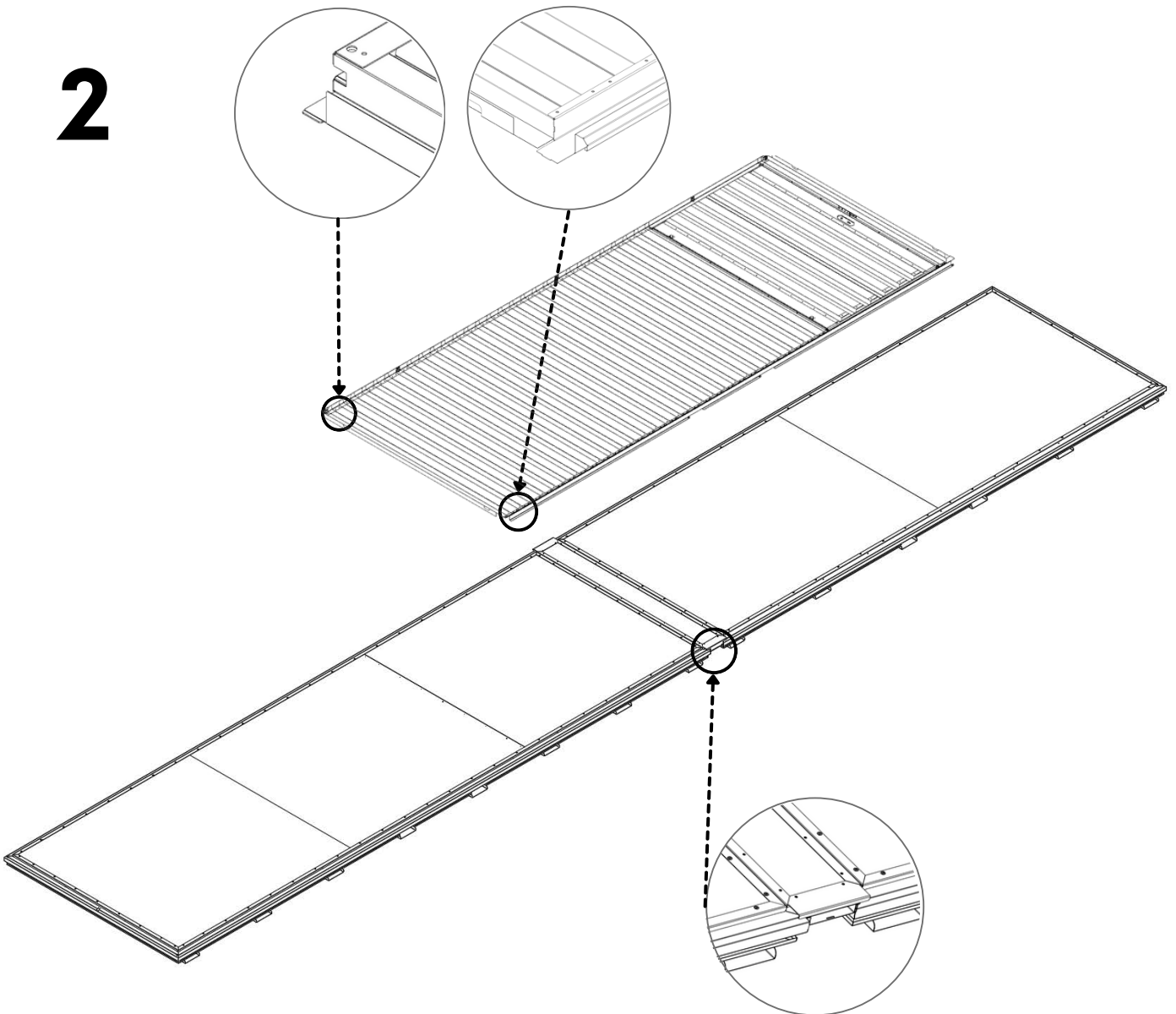

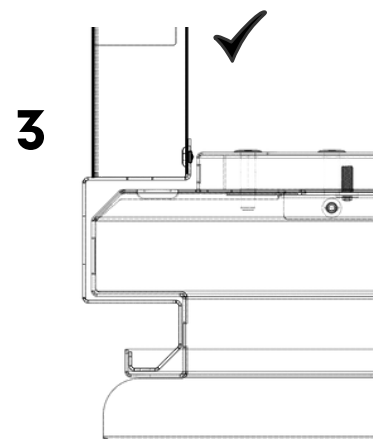
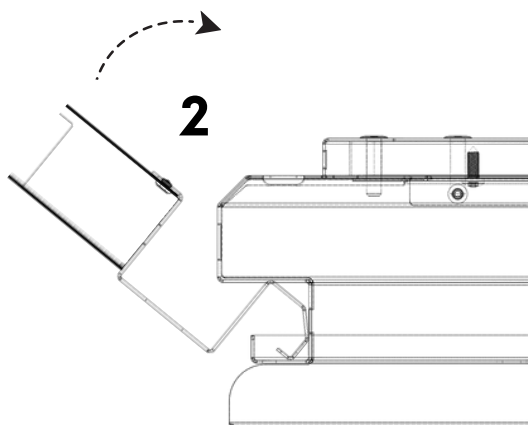
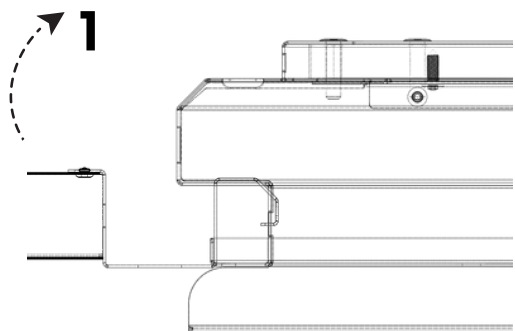

3

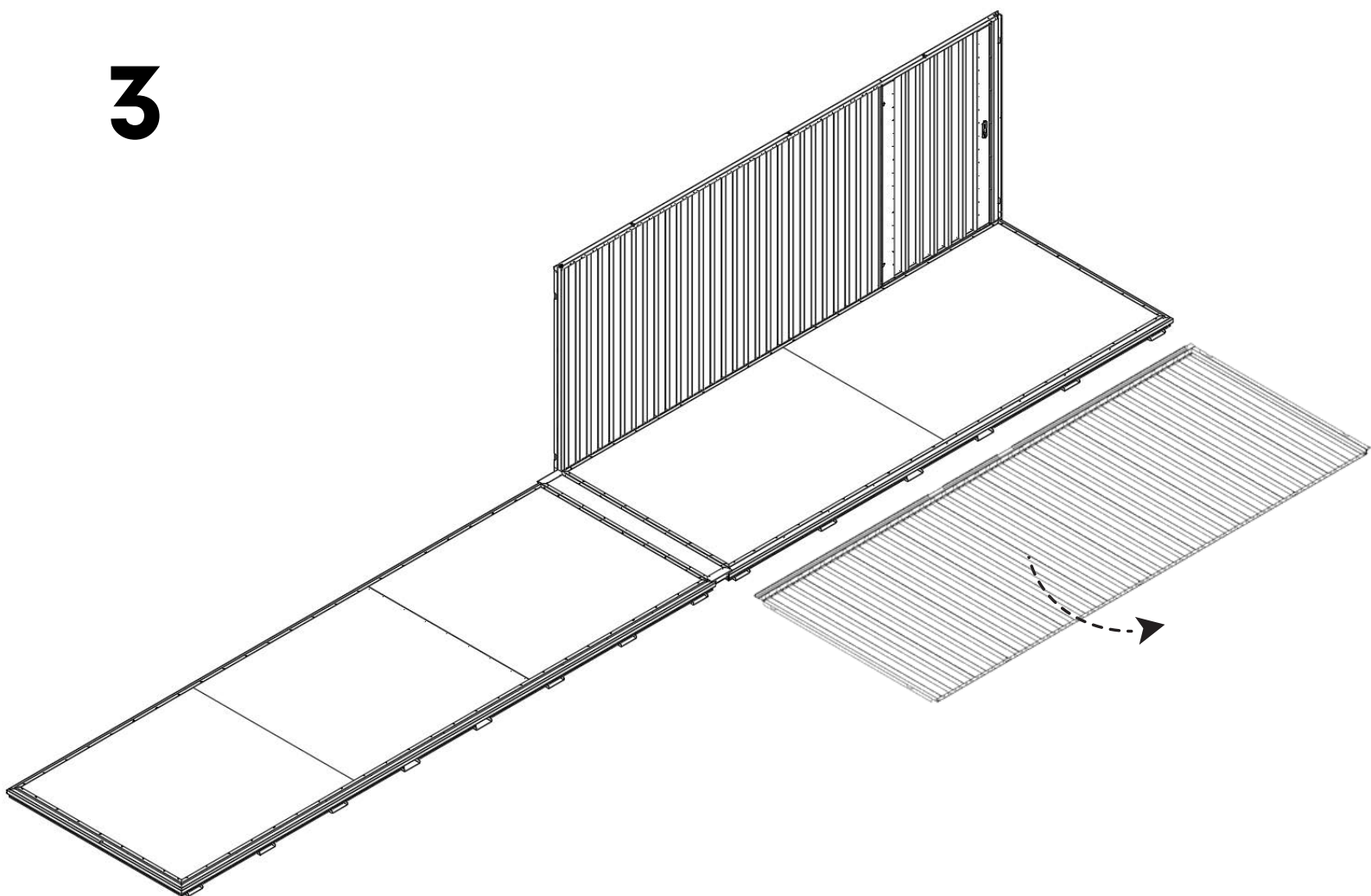

4

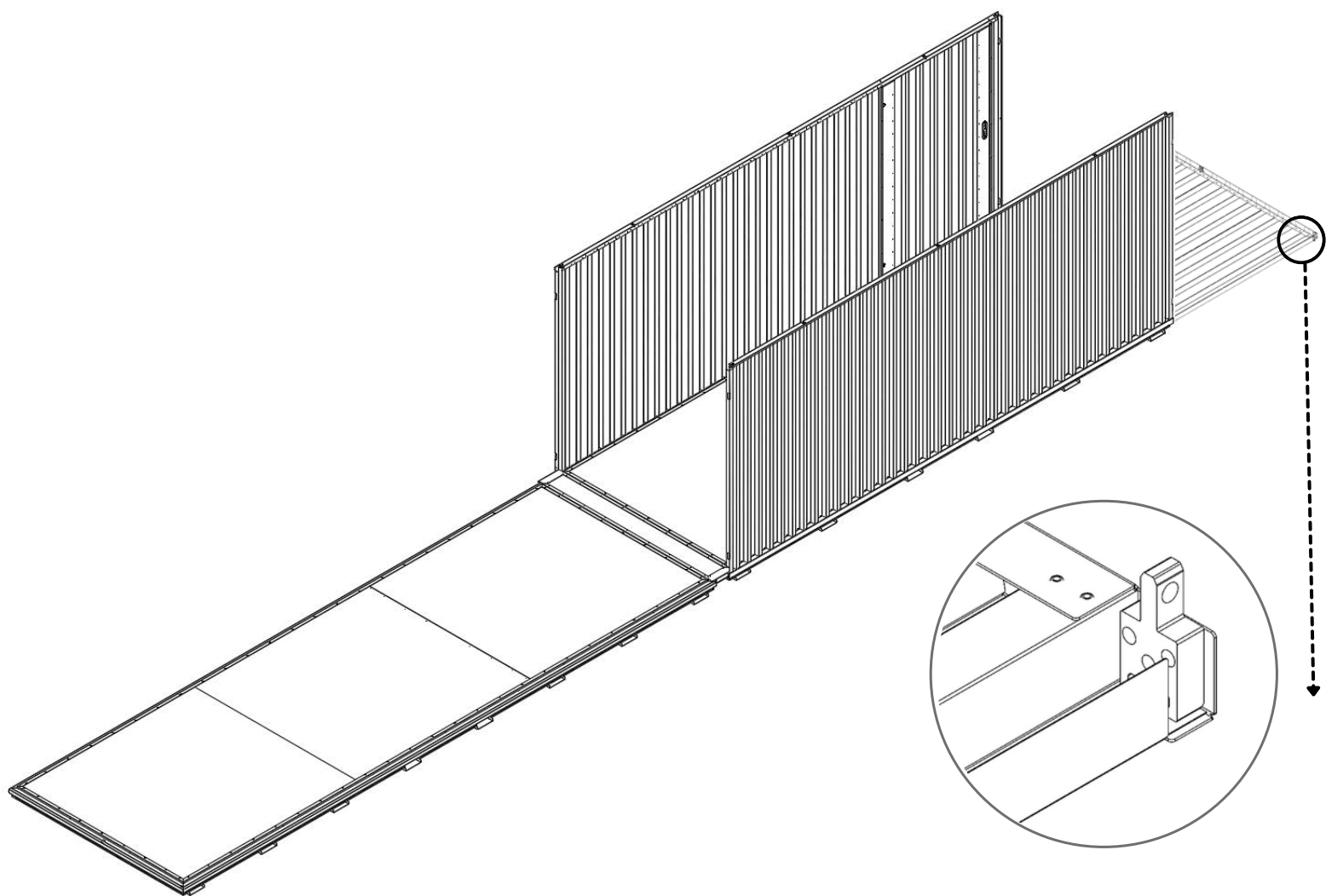

4.1

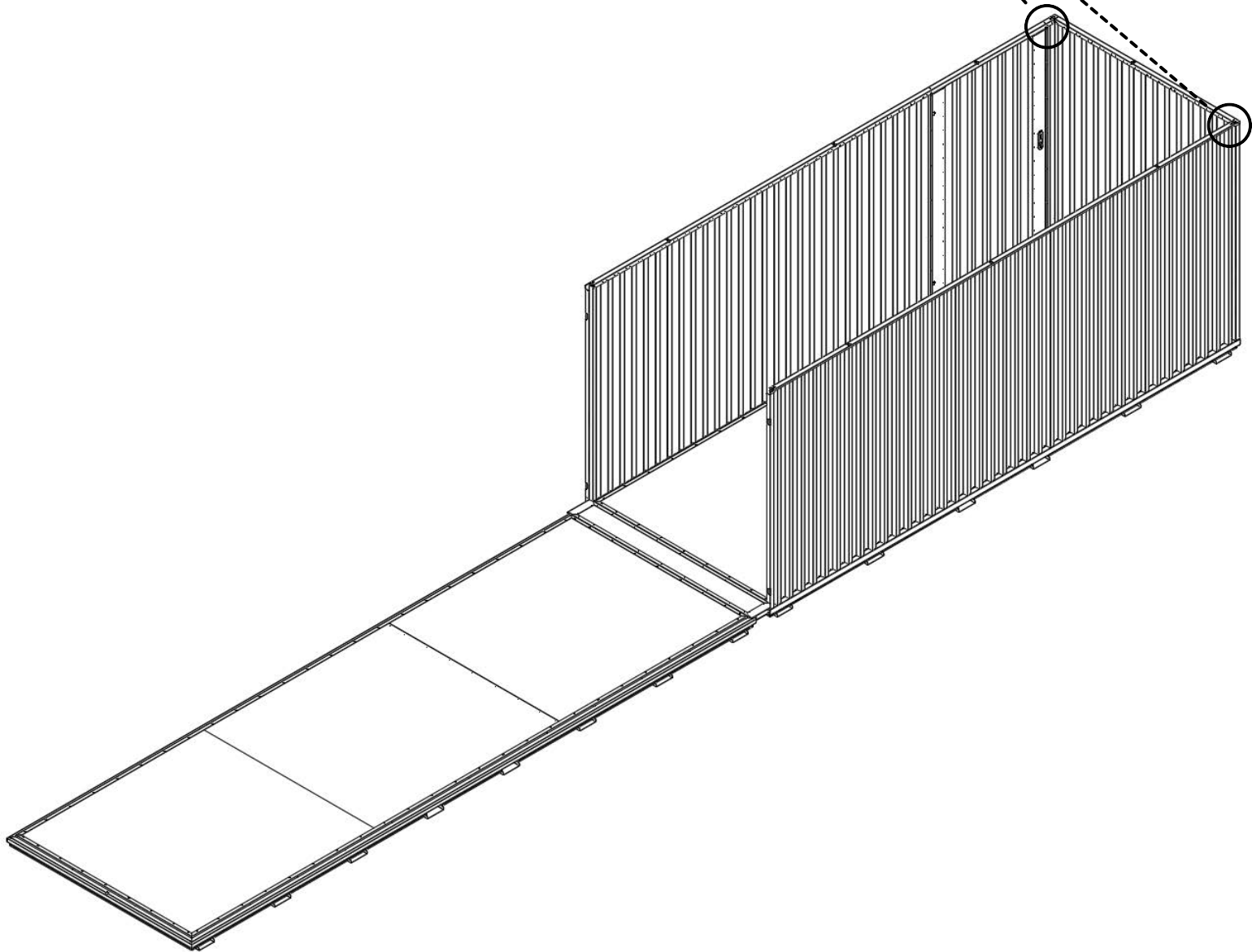
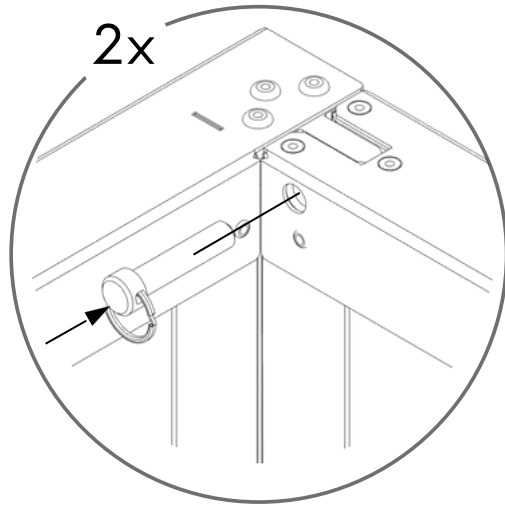

5

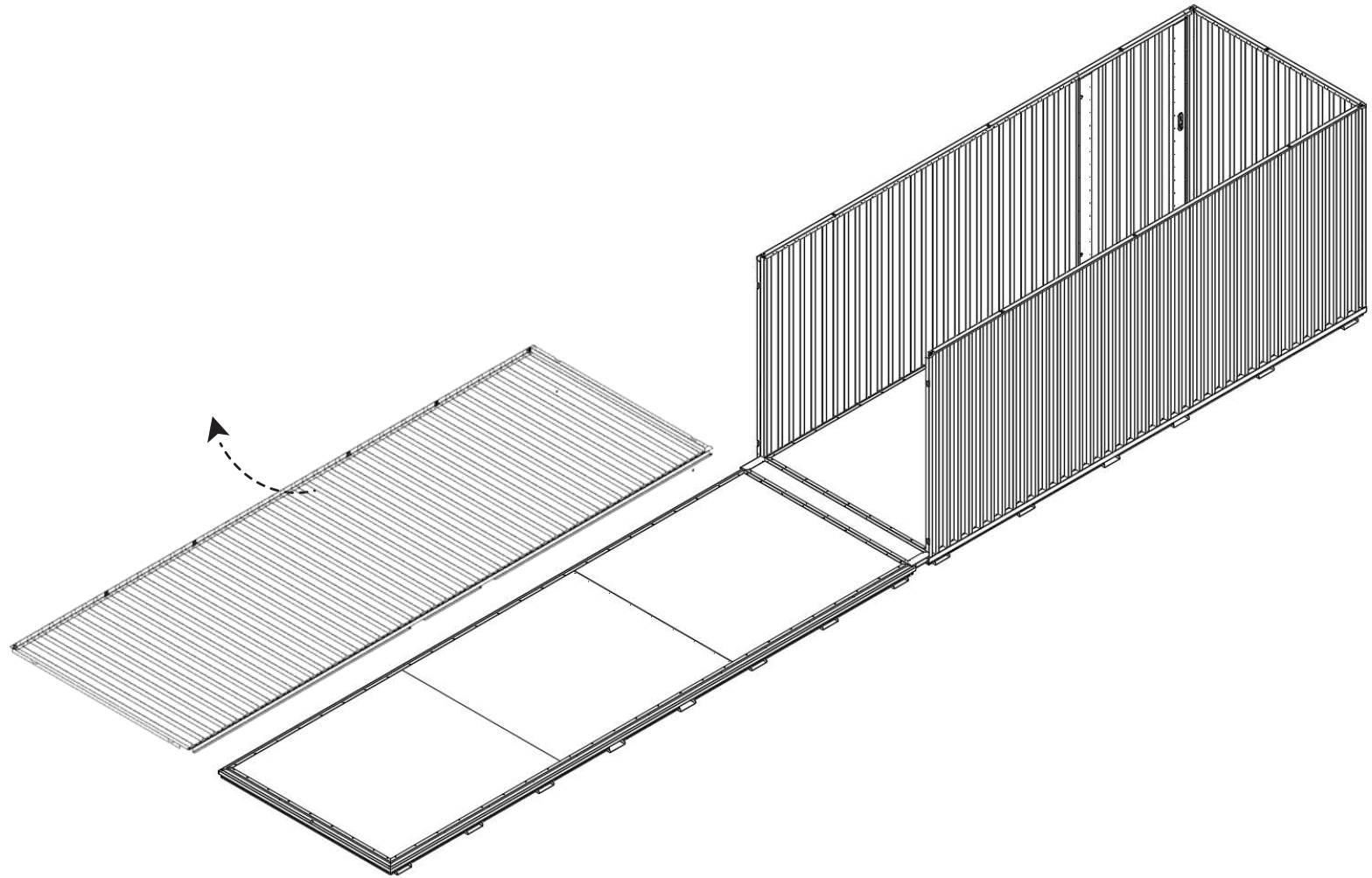

6

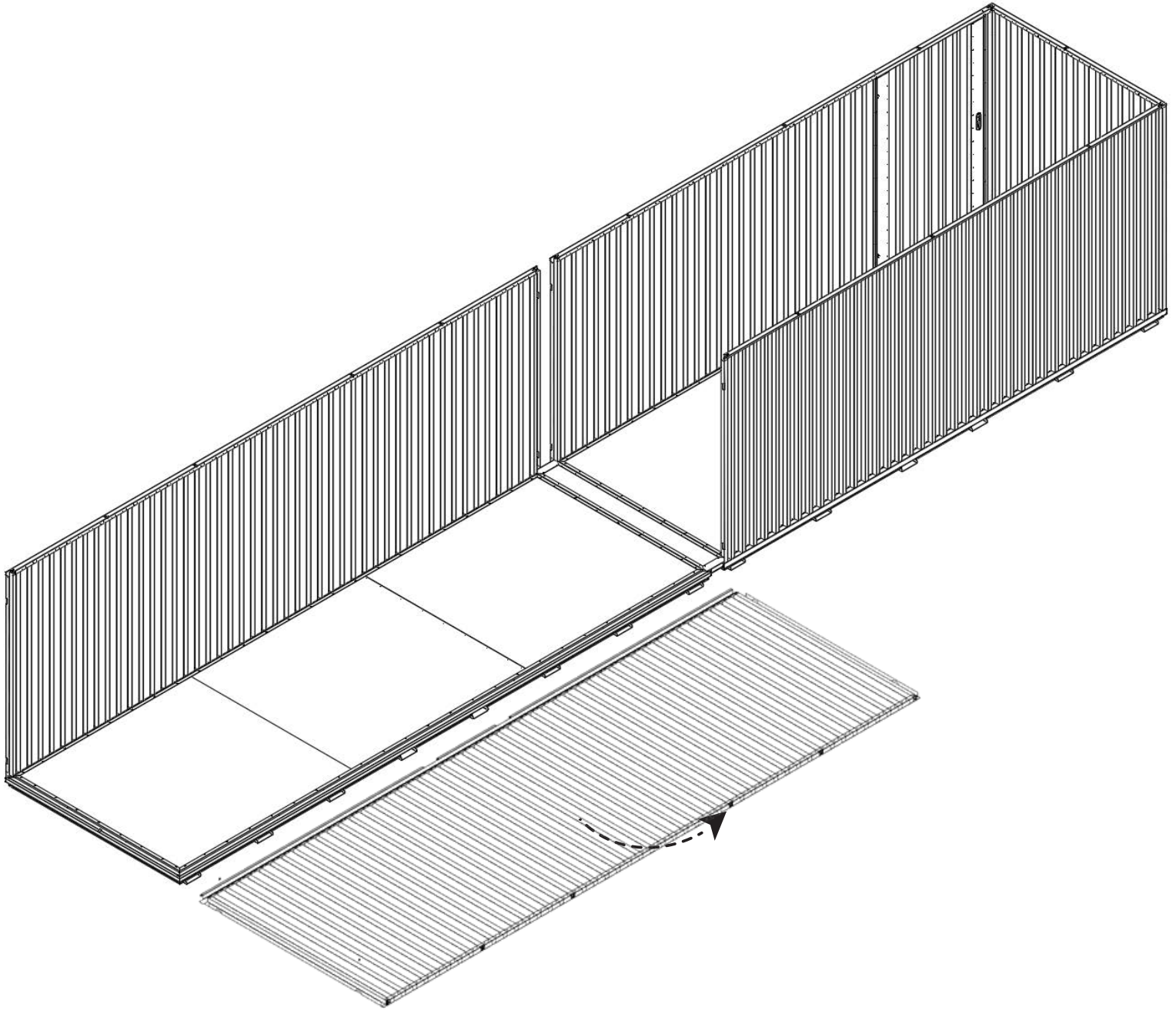

7

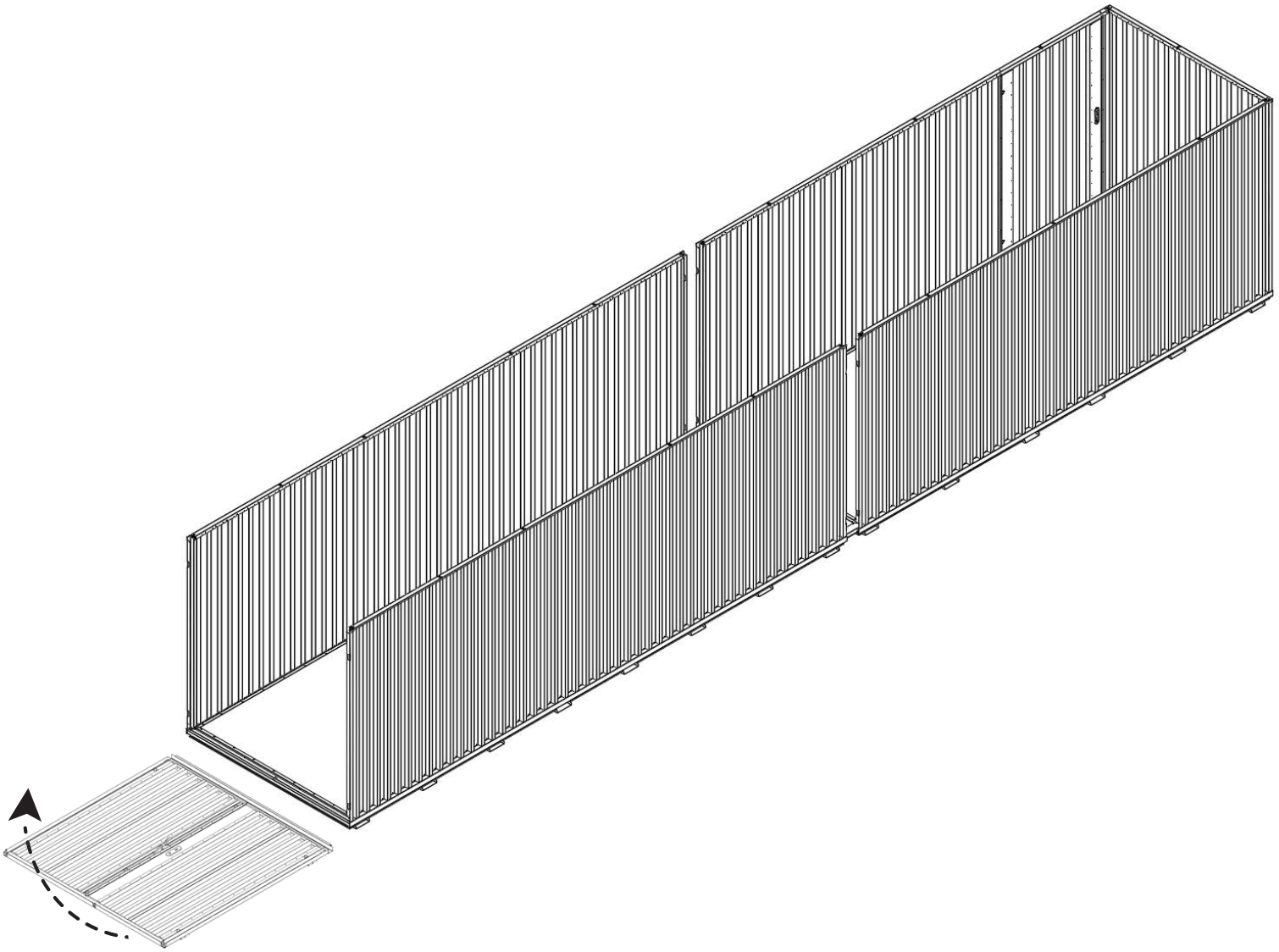

7.1

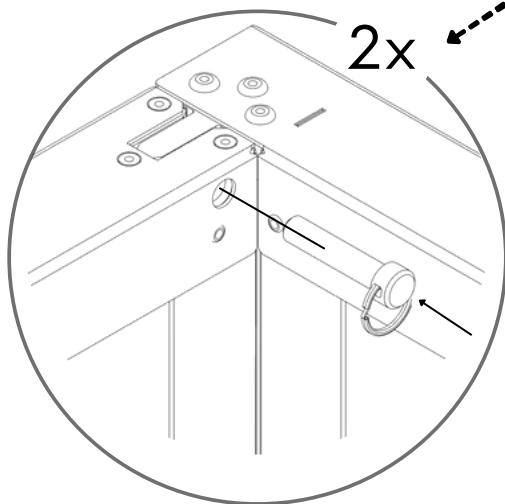
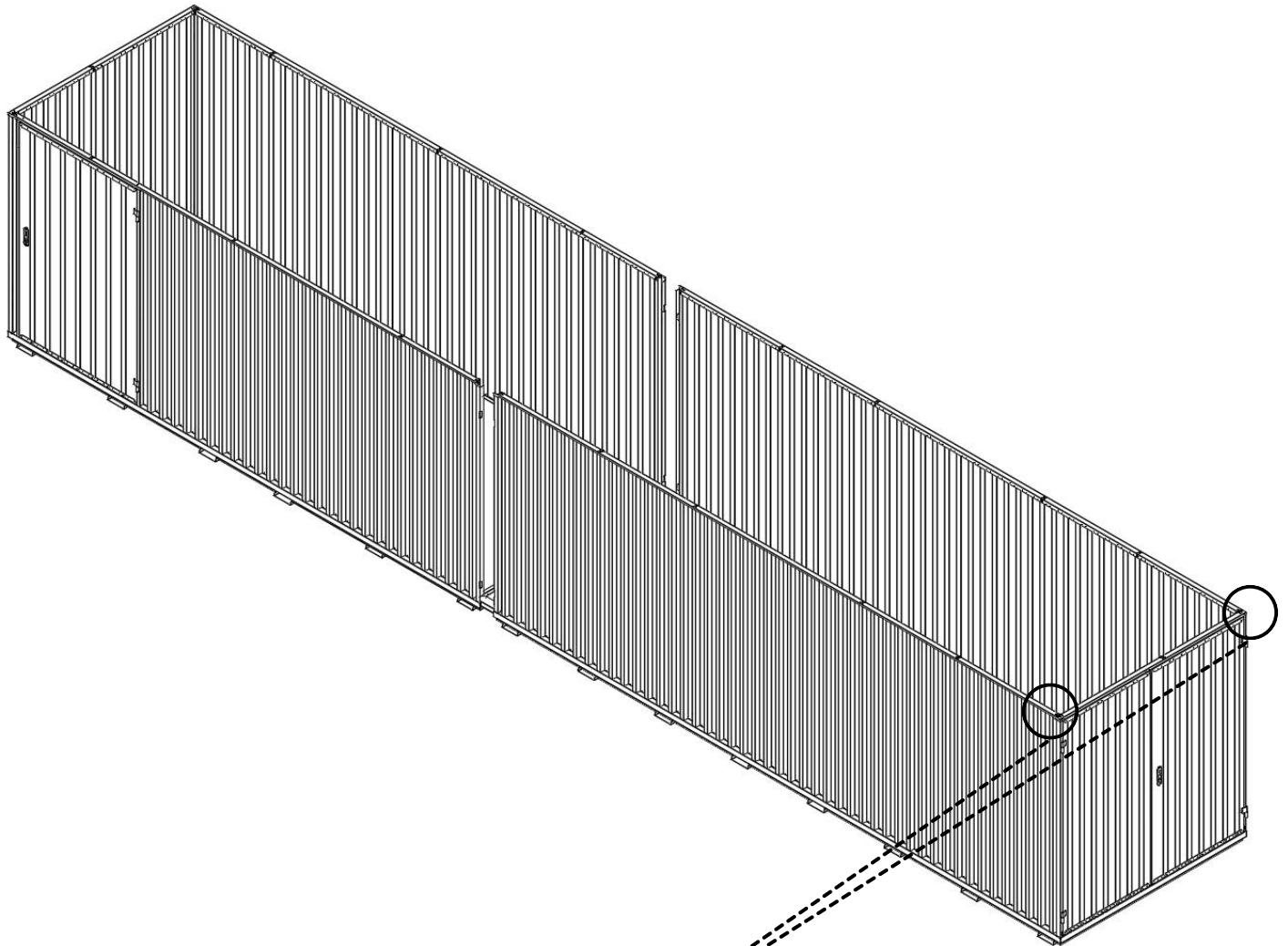

8

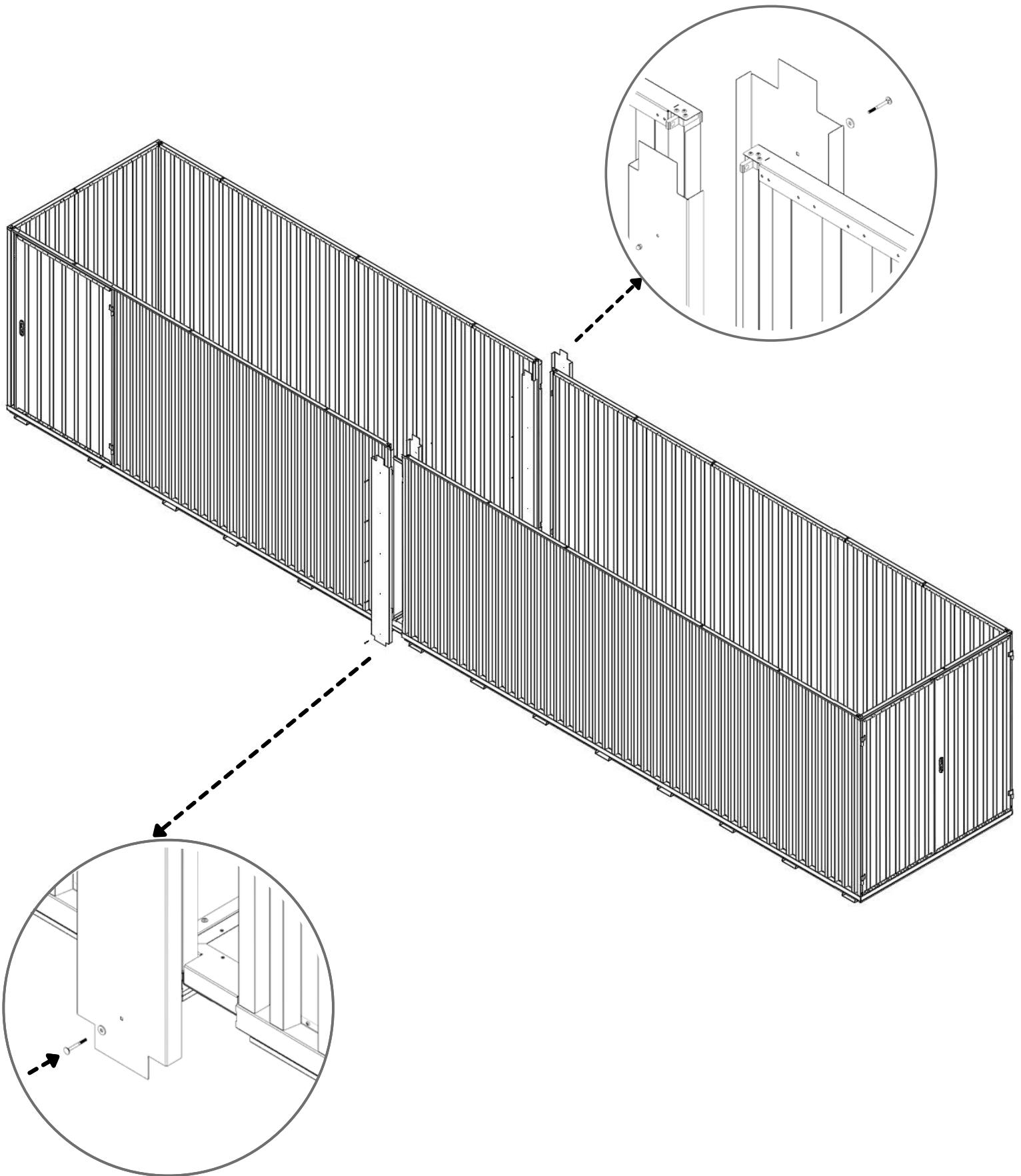

9

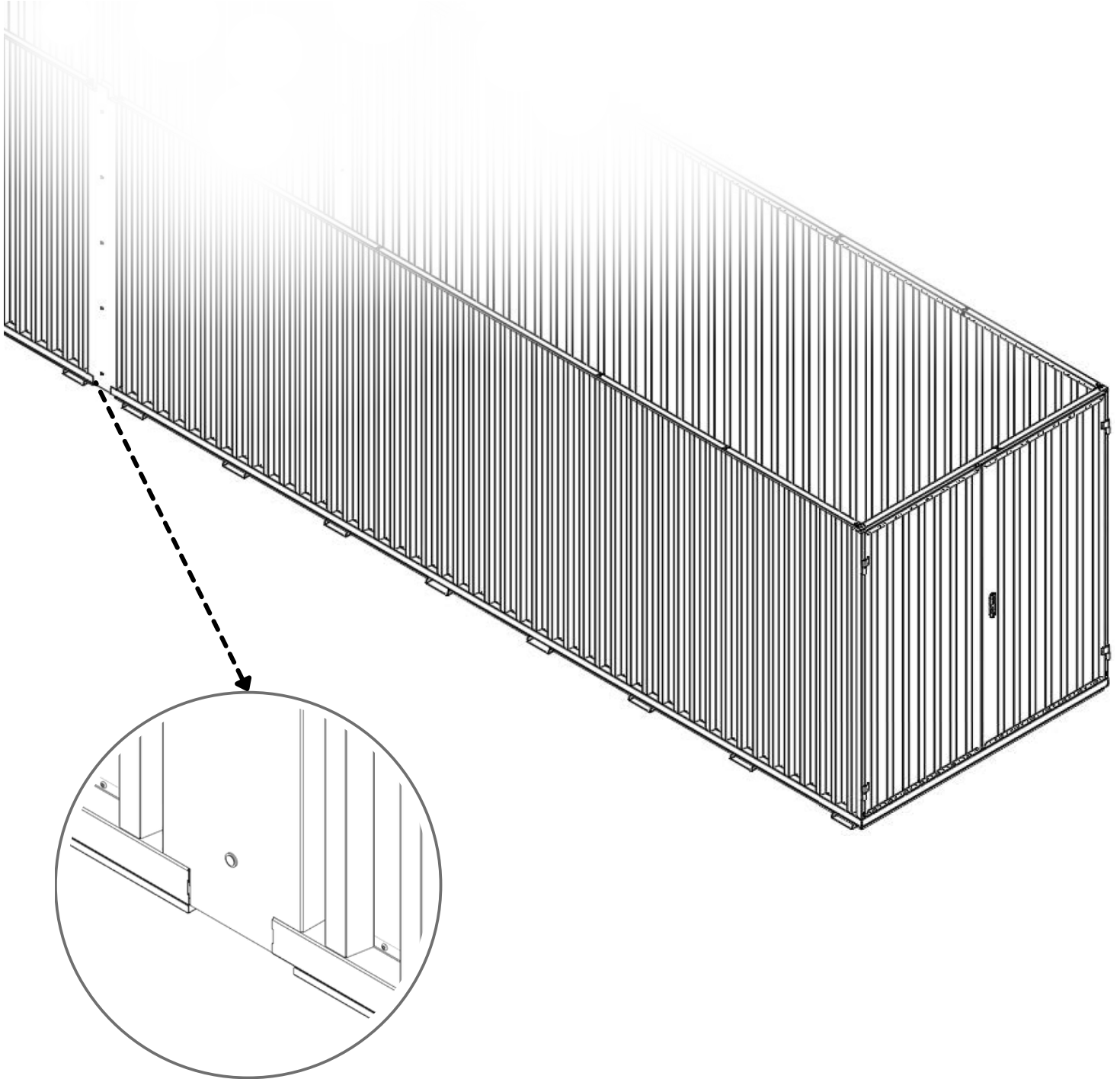



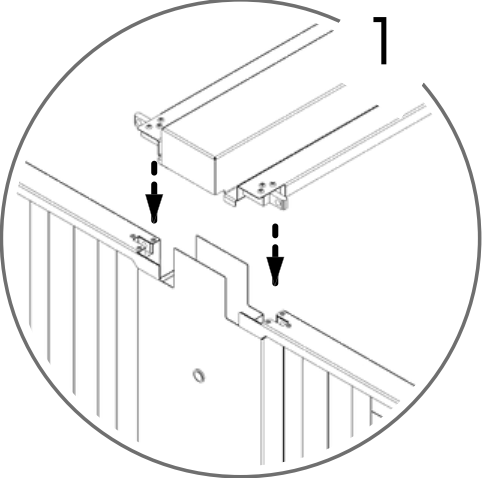
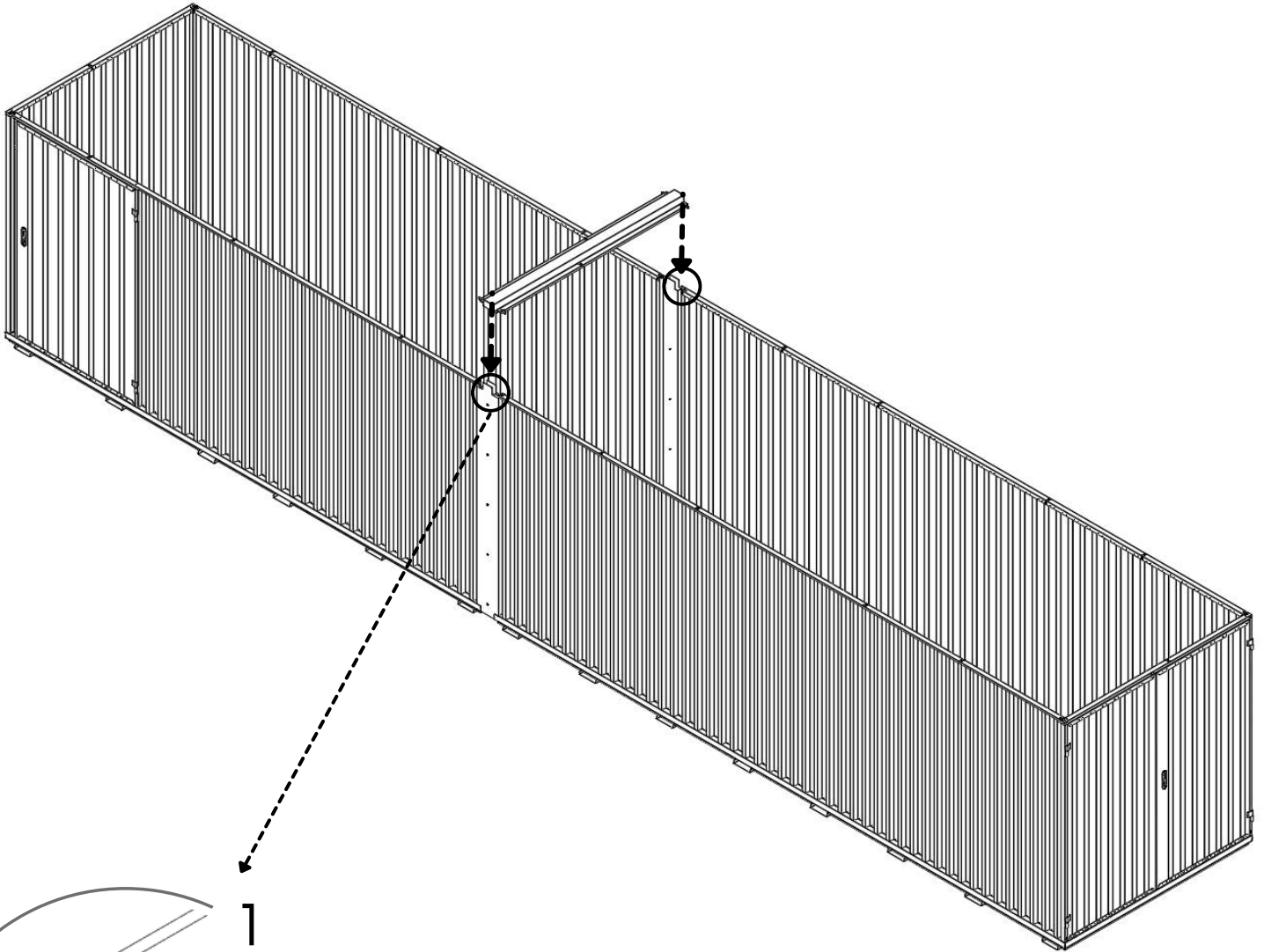



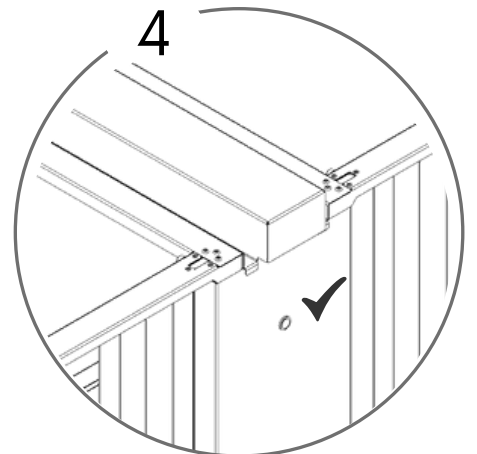
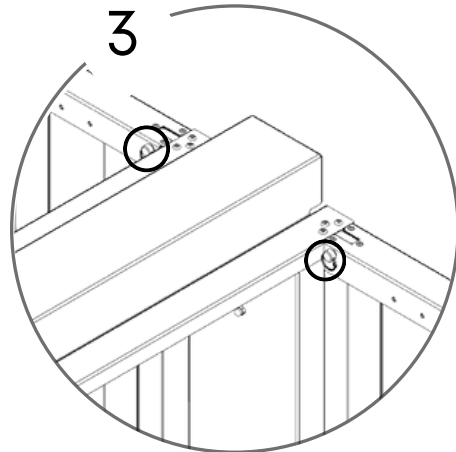
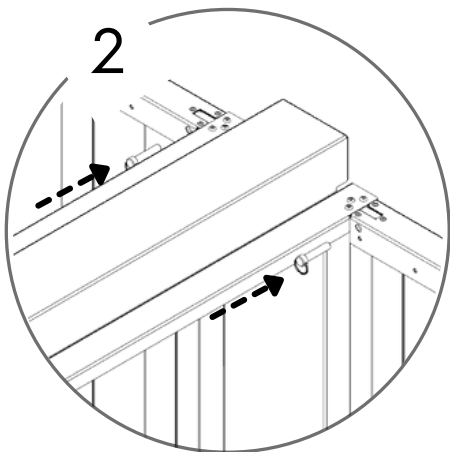
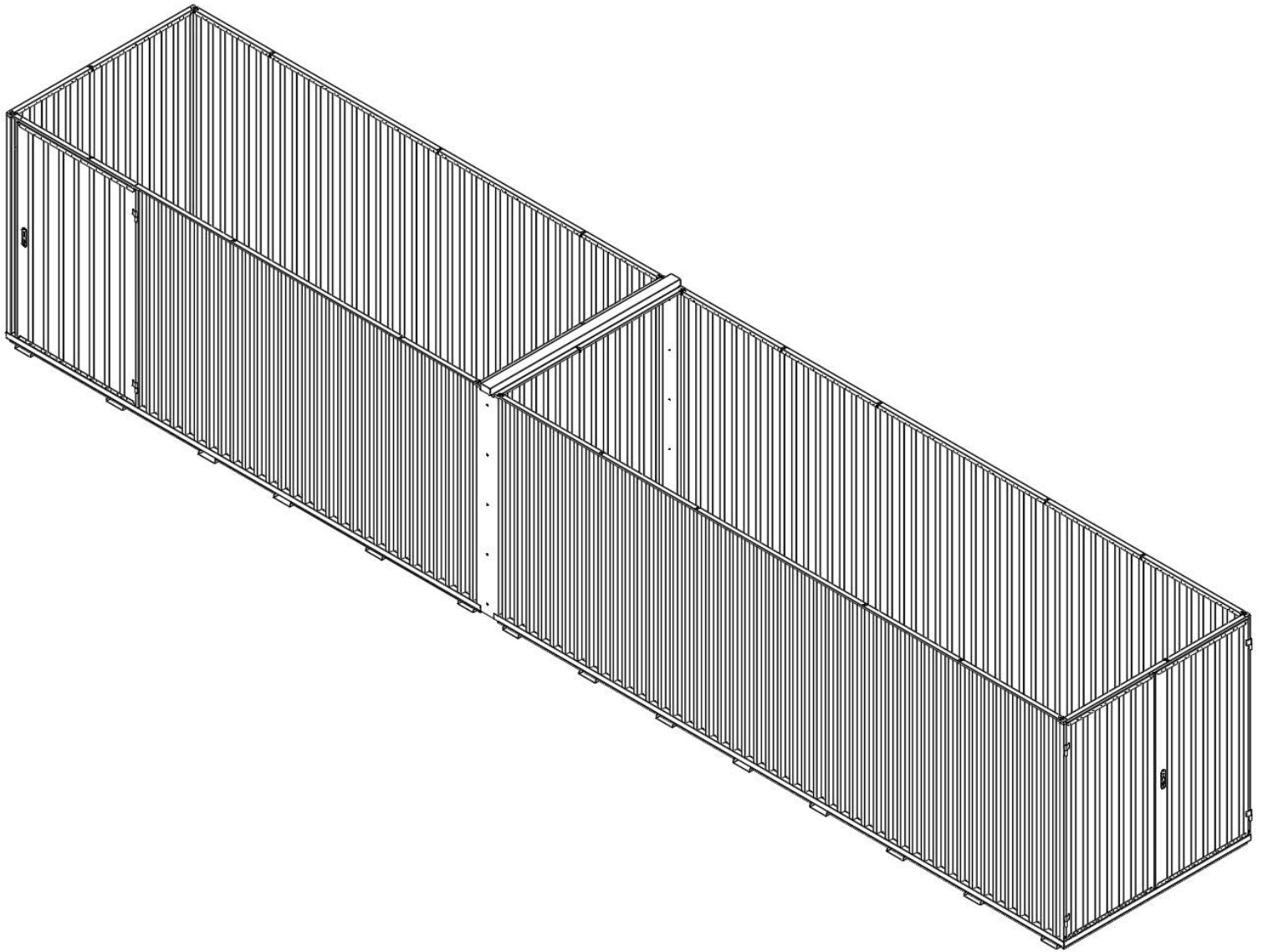

10



11





 1049 KG	 1640 MM	Model Code: 6050.110.450.330 Production Tracking Code:/X09.1.6050.450.330	 9001	 14001	 50001			
--	--	---	---	--	--	---	---	---

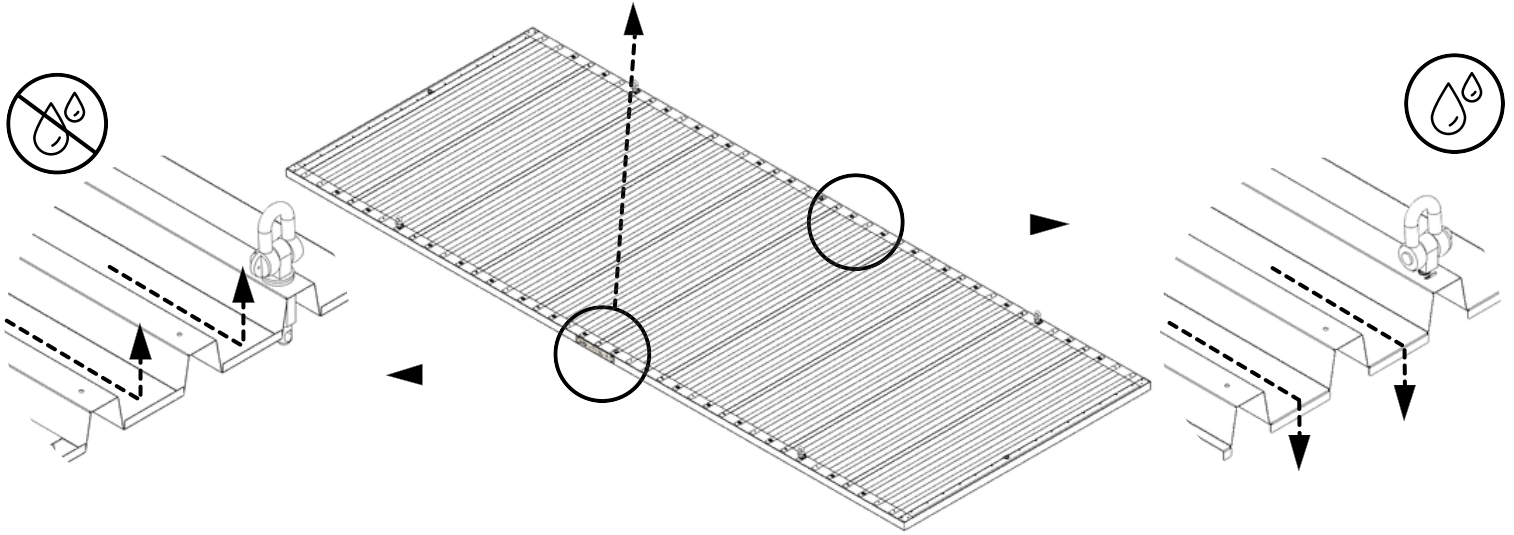

12

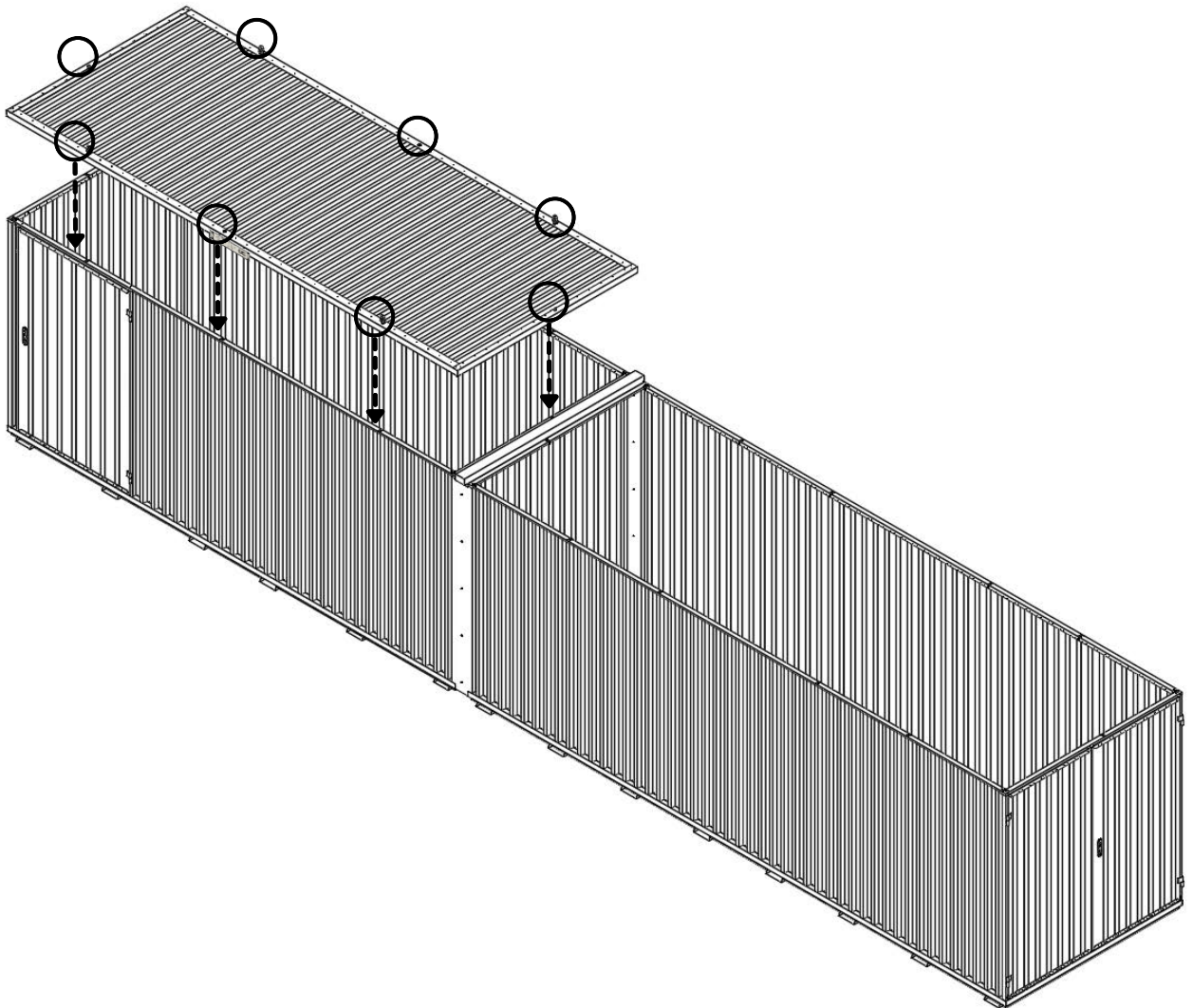

13

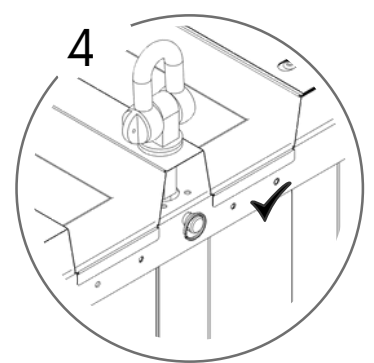
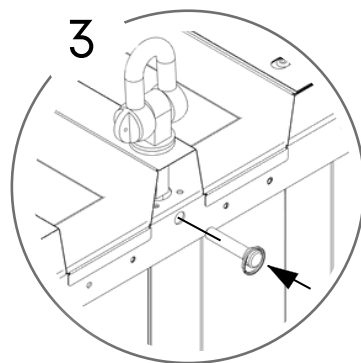
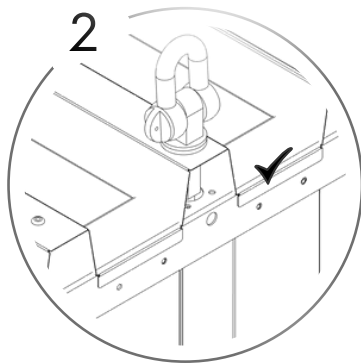
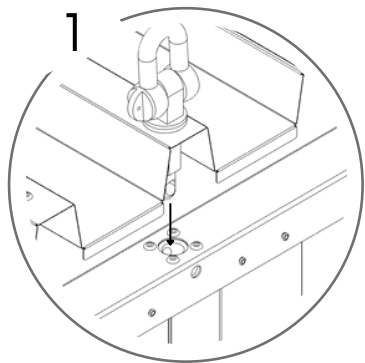
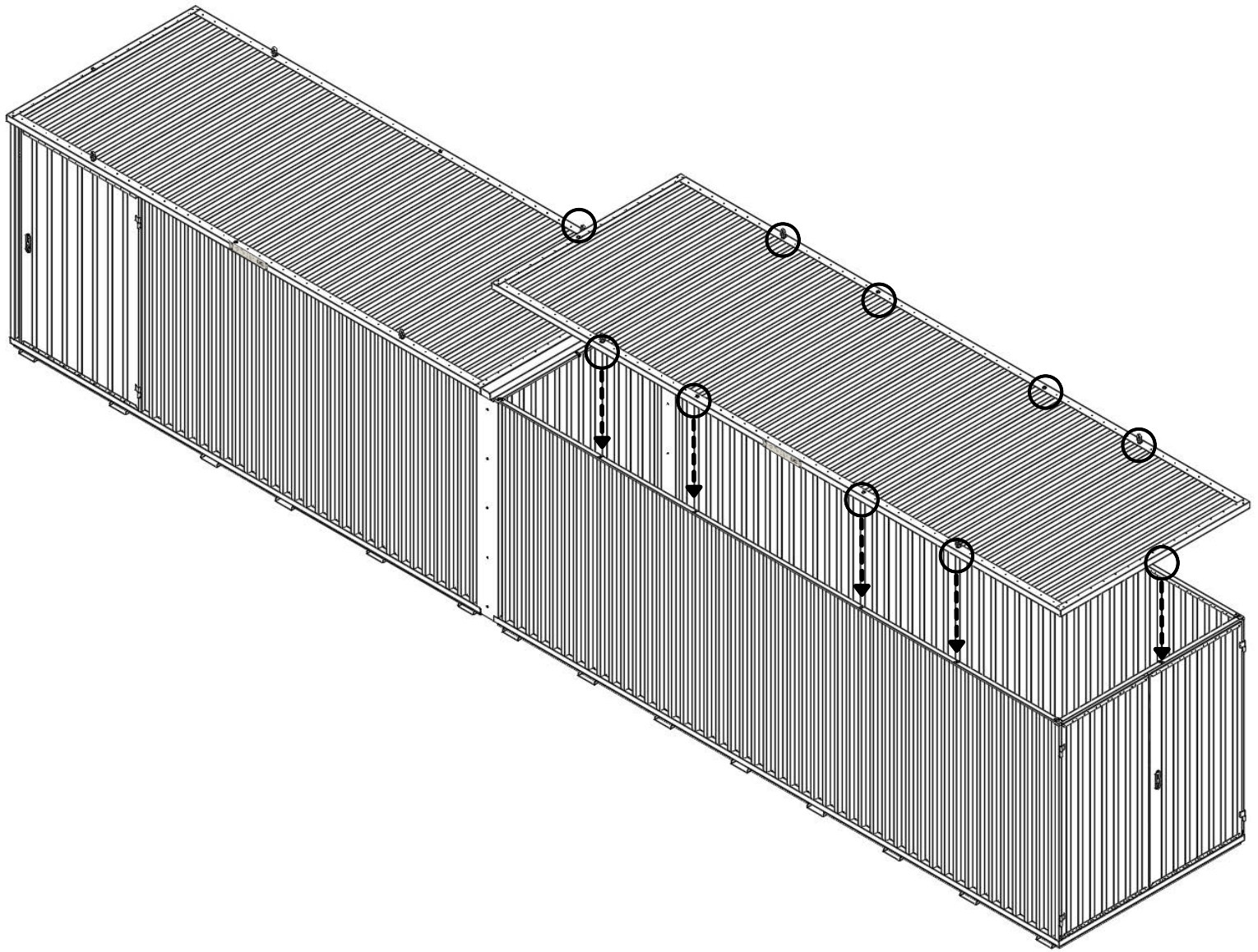

14

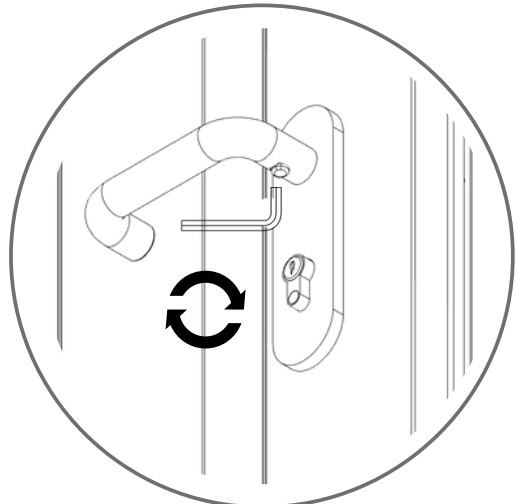
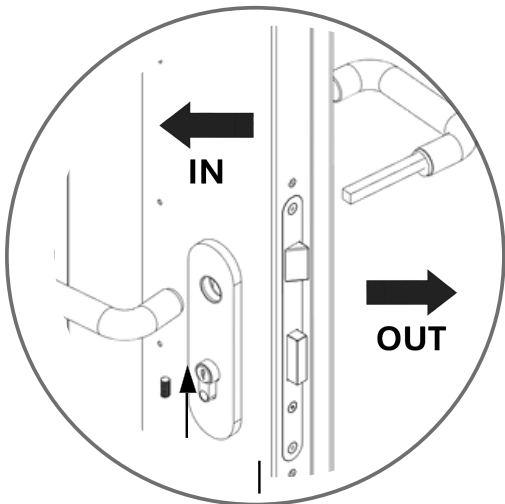
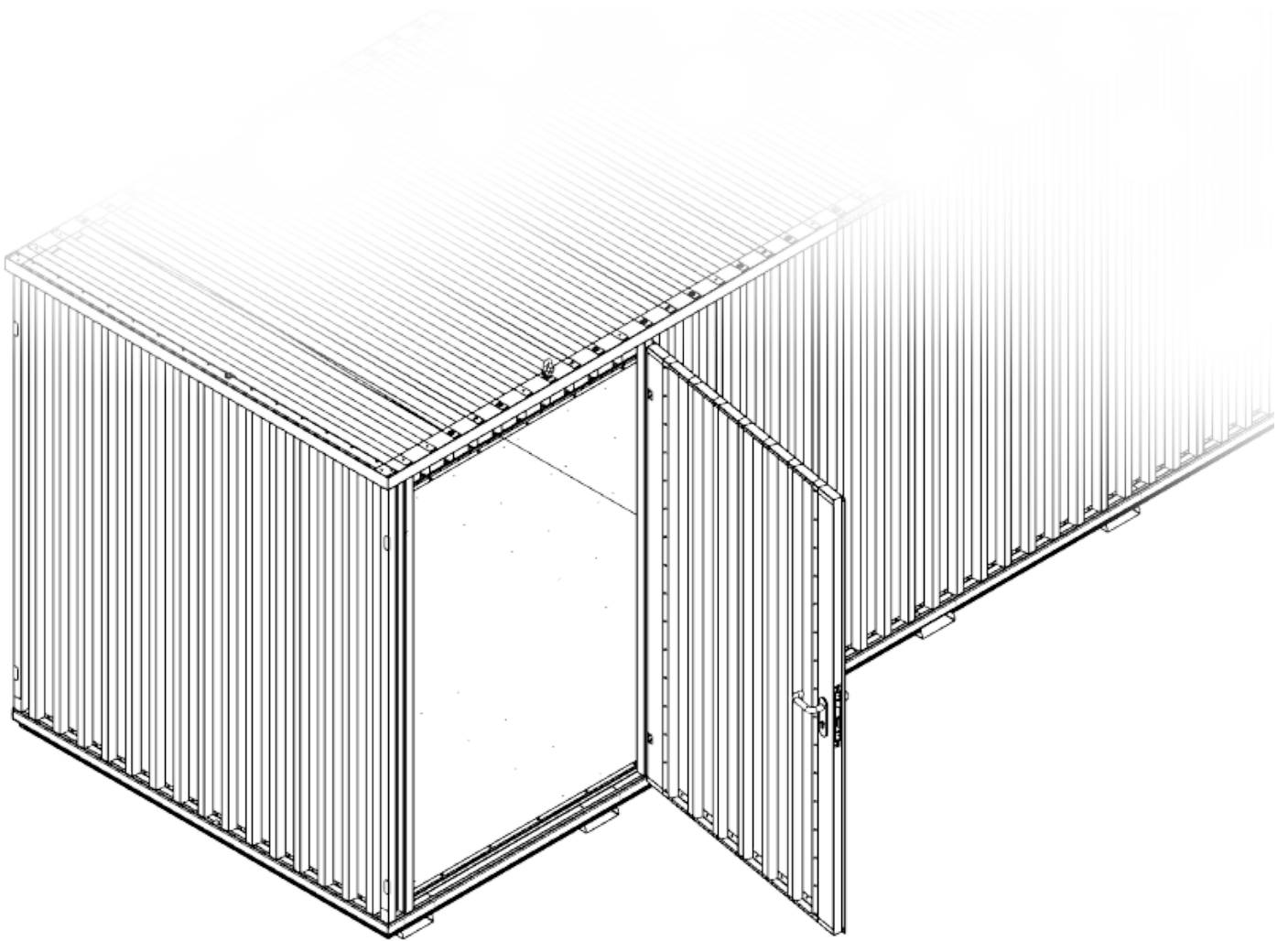

15

