

PRODUCT CODE:4030.110.440.330

prefabase
Quick Build Solutions

Instructions and User Guide

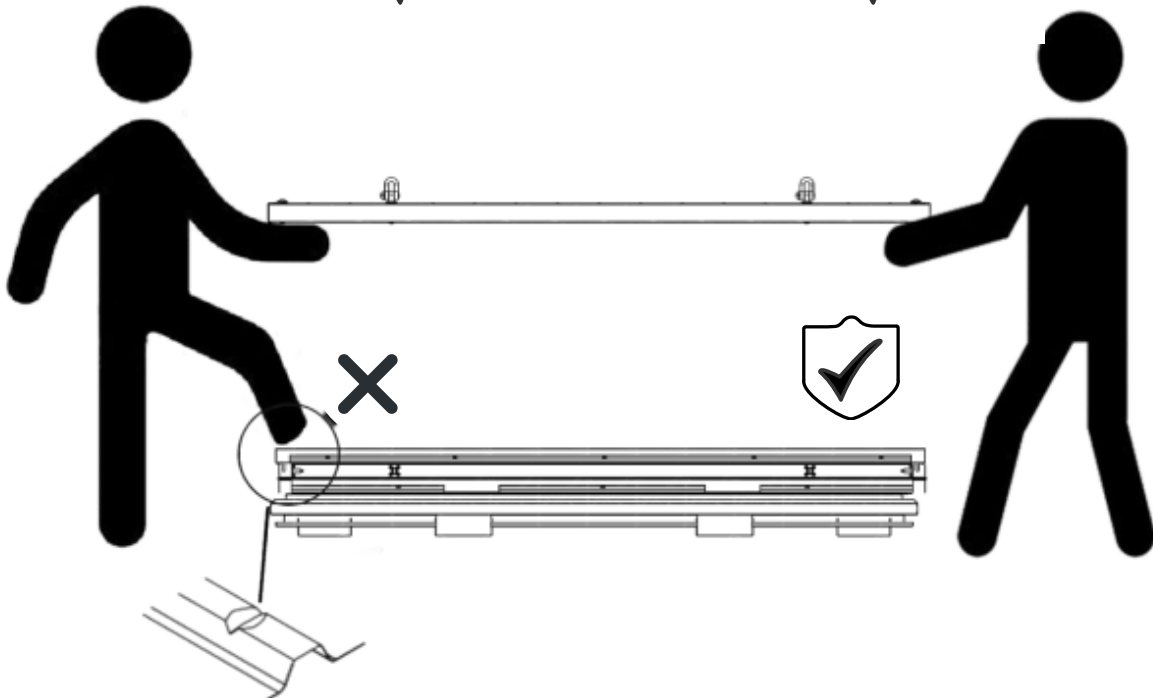
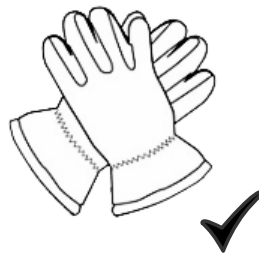

40.0110
1x

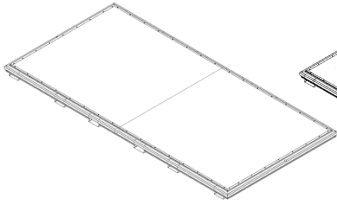

30.0110
1x

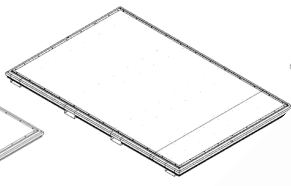

40.0510
1x

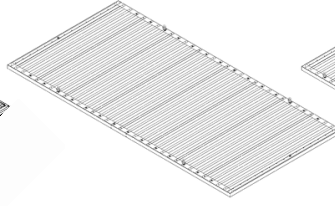

30.0510
1x

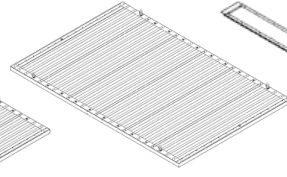

306.0110
1x

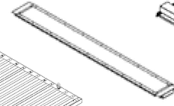

306.0510
1x



40.0410
2x

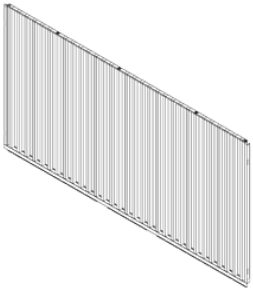

30.0410
1x

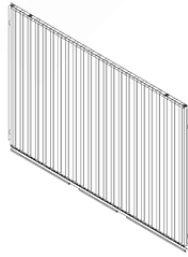

30.0440
1x

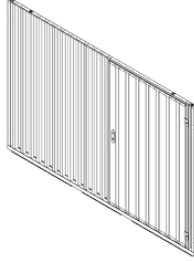

0310
1x

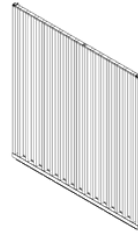

0330
1x



306.40.05
2x



306.40.04
2x



61.101
2x



22x

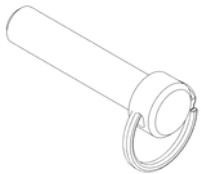

2x

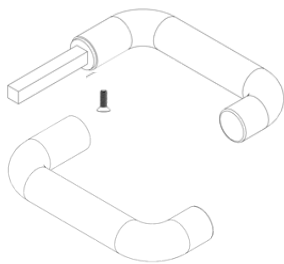

10x



10x



10x



1x



2x



1

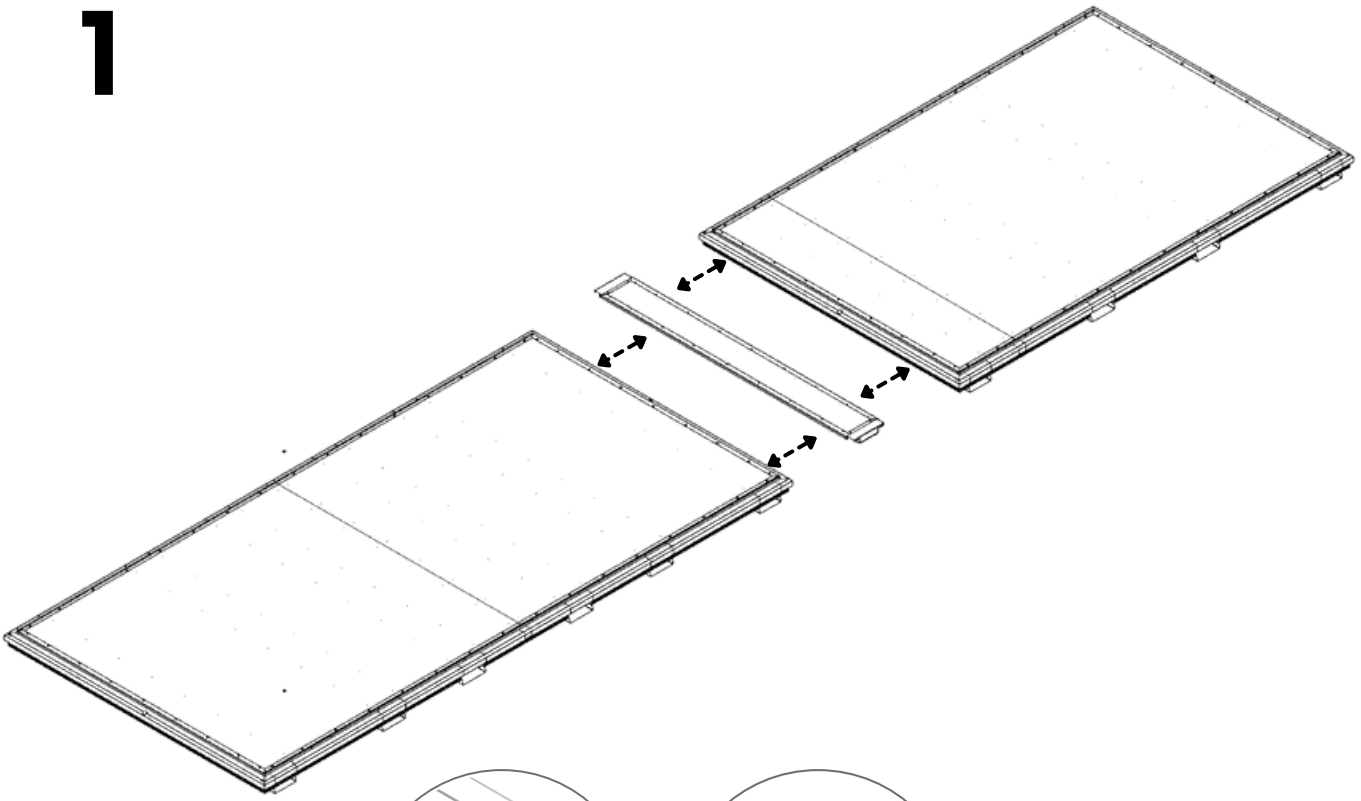

2

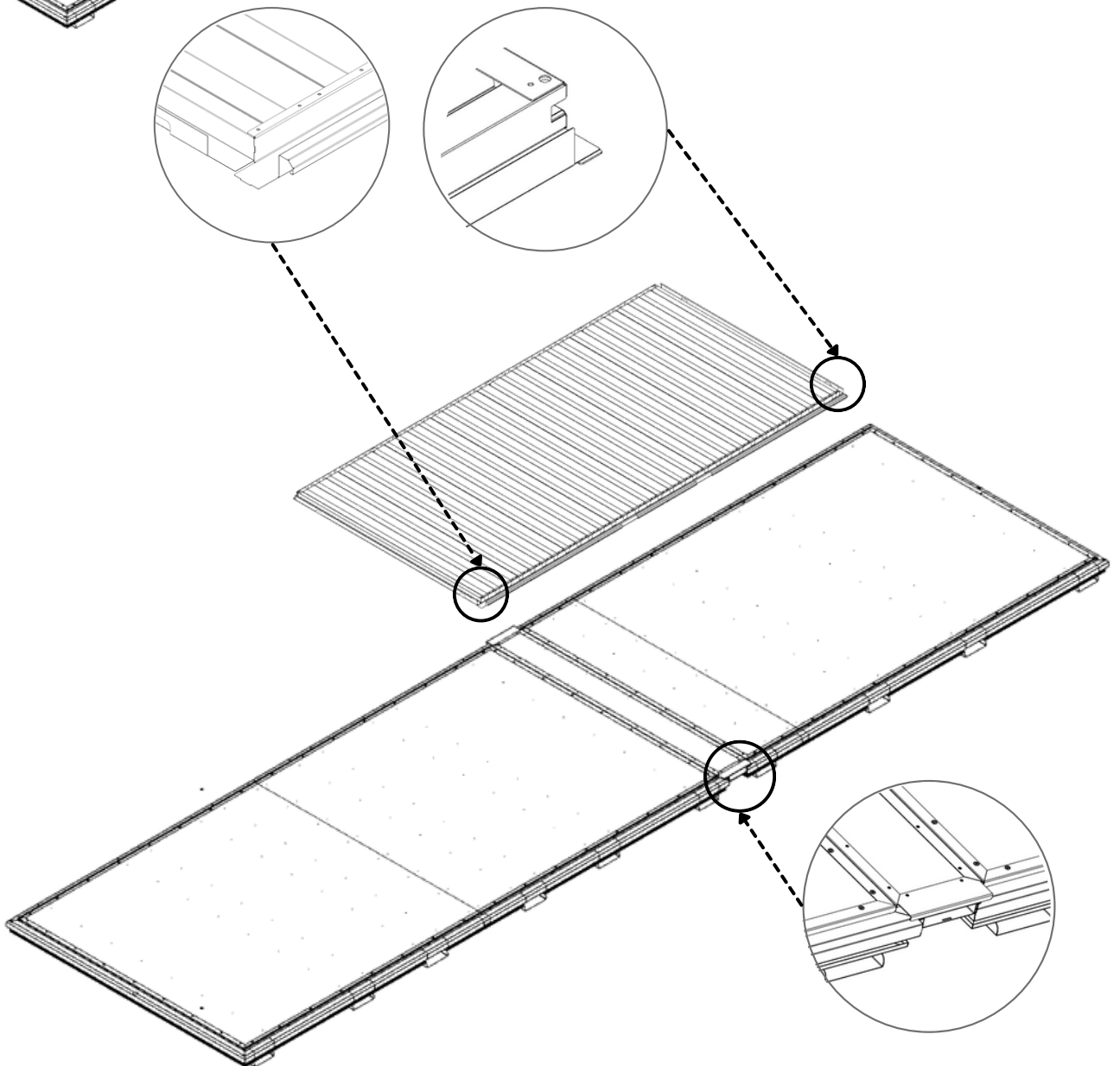

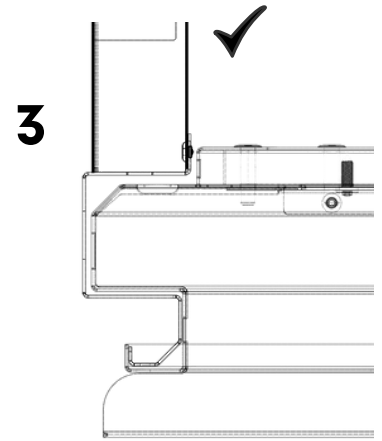
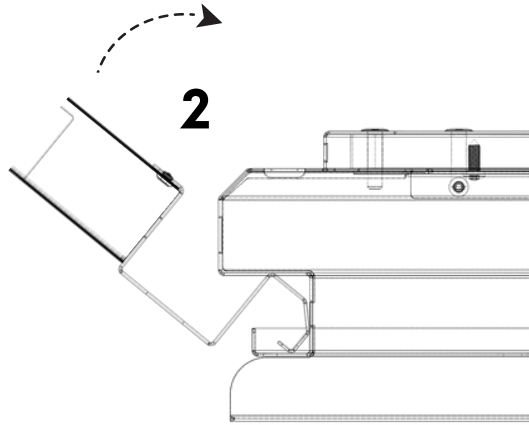
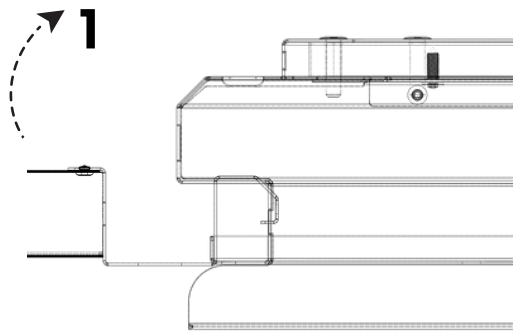

3

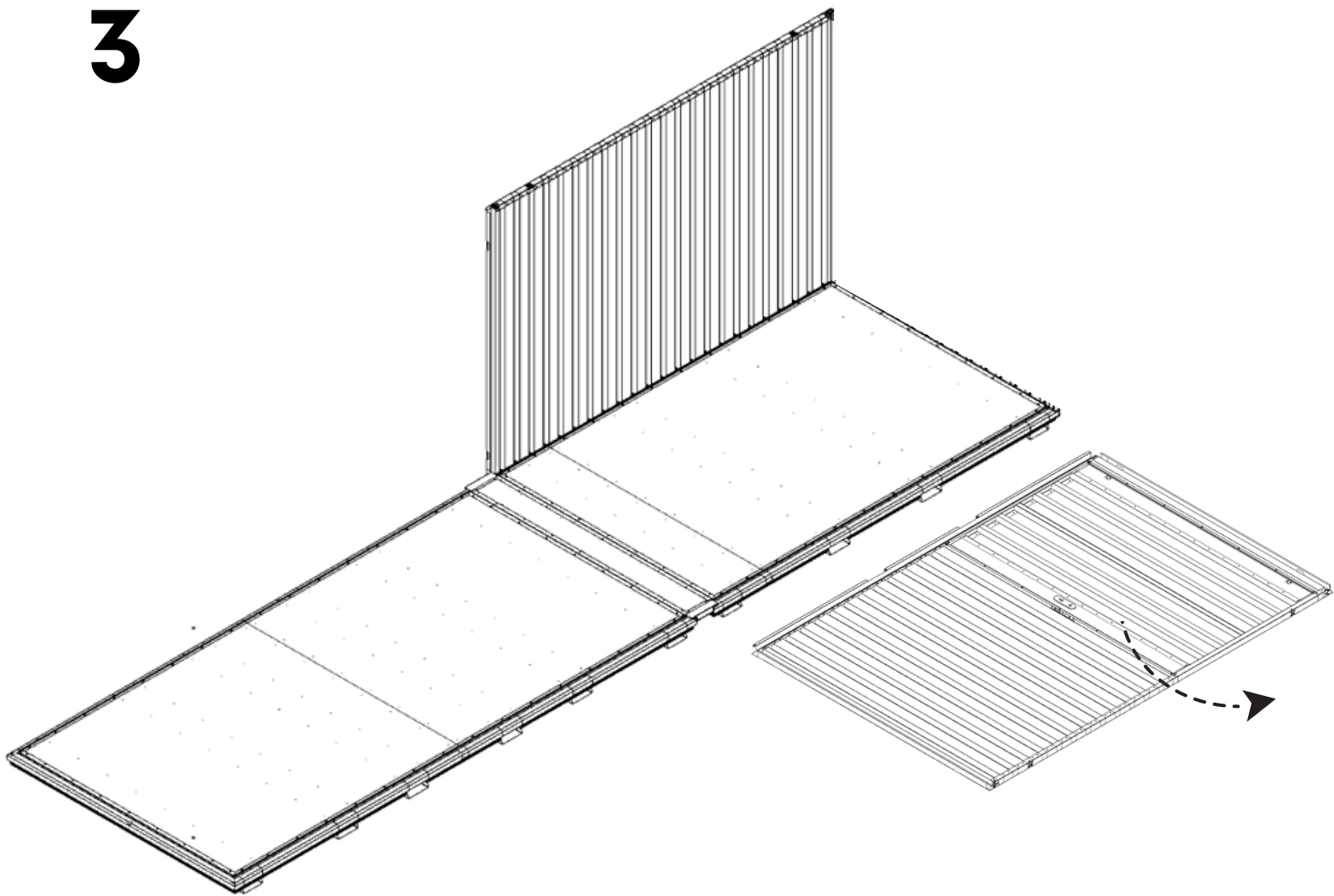

4

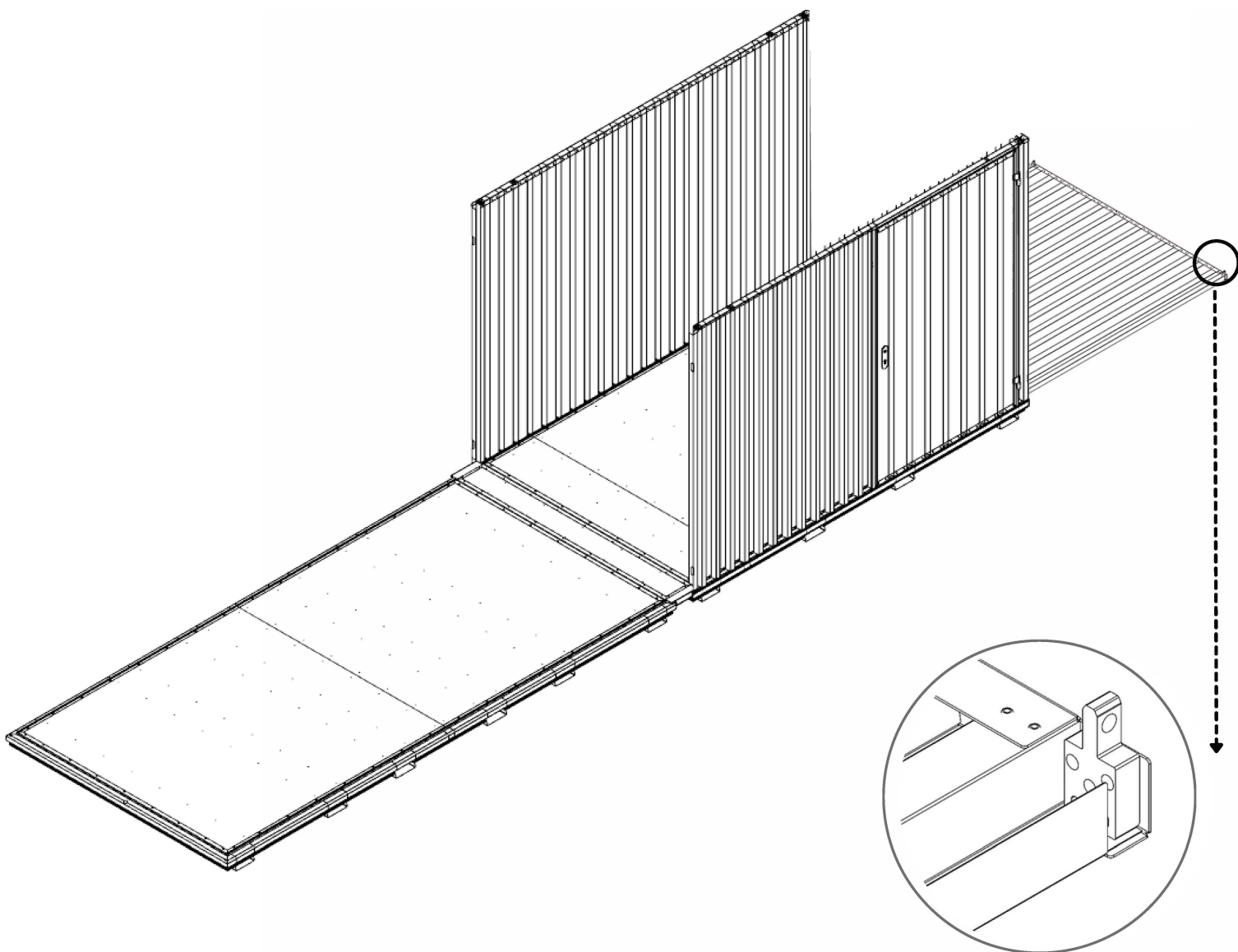

4.1

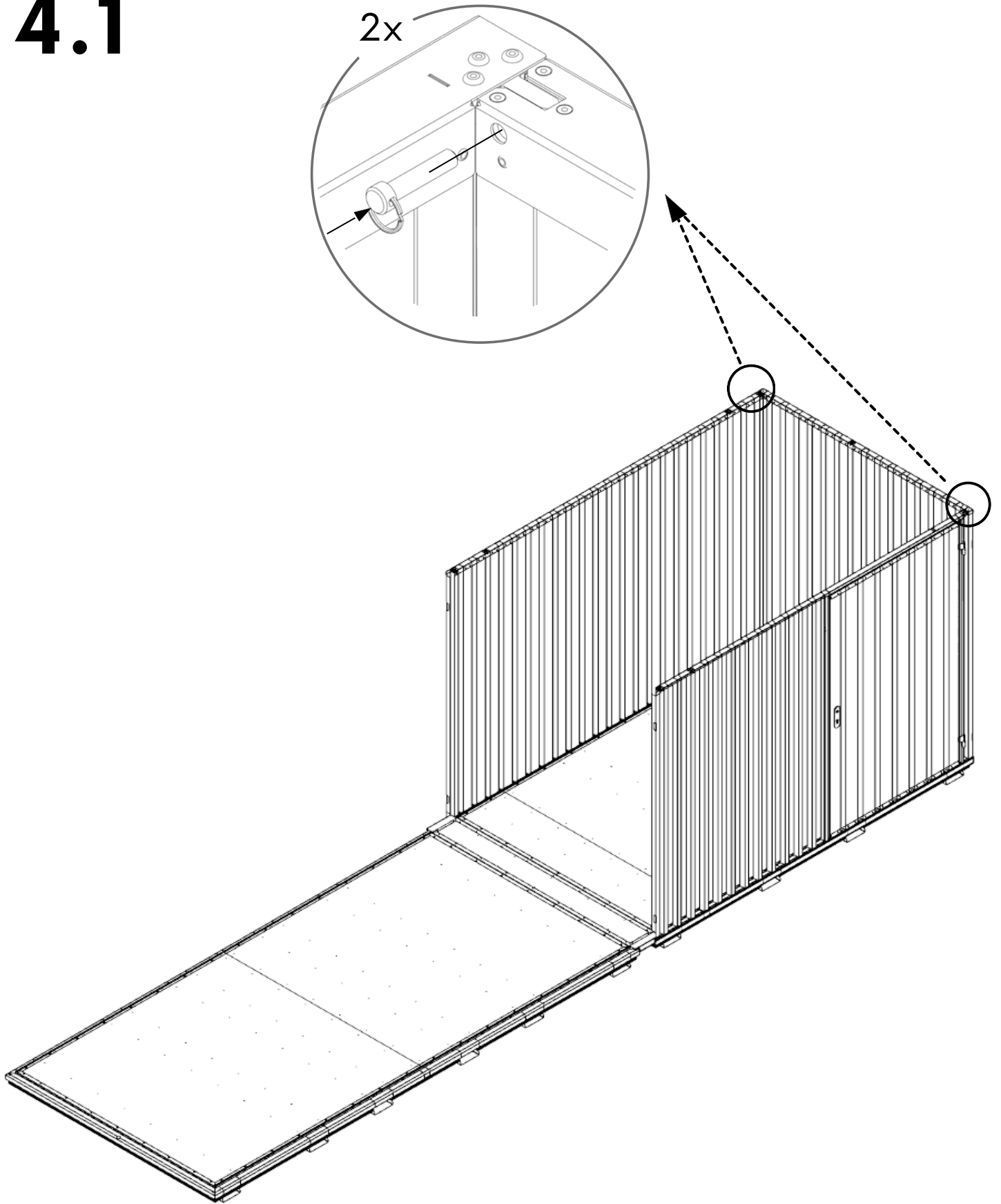

5

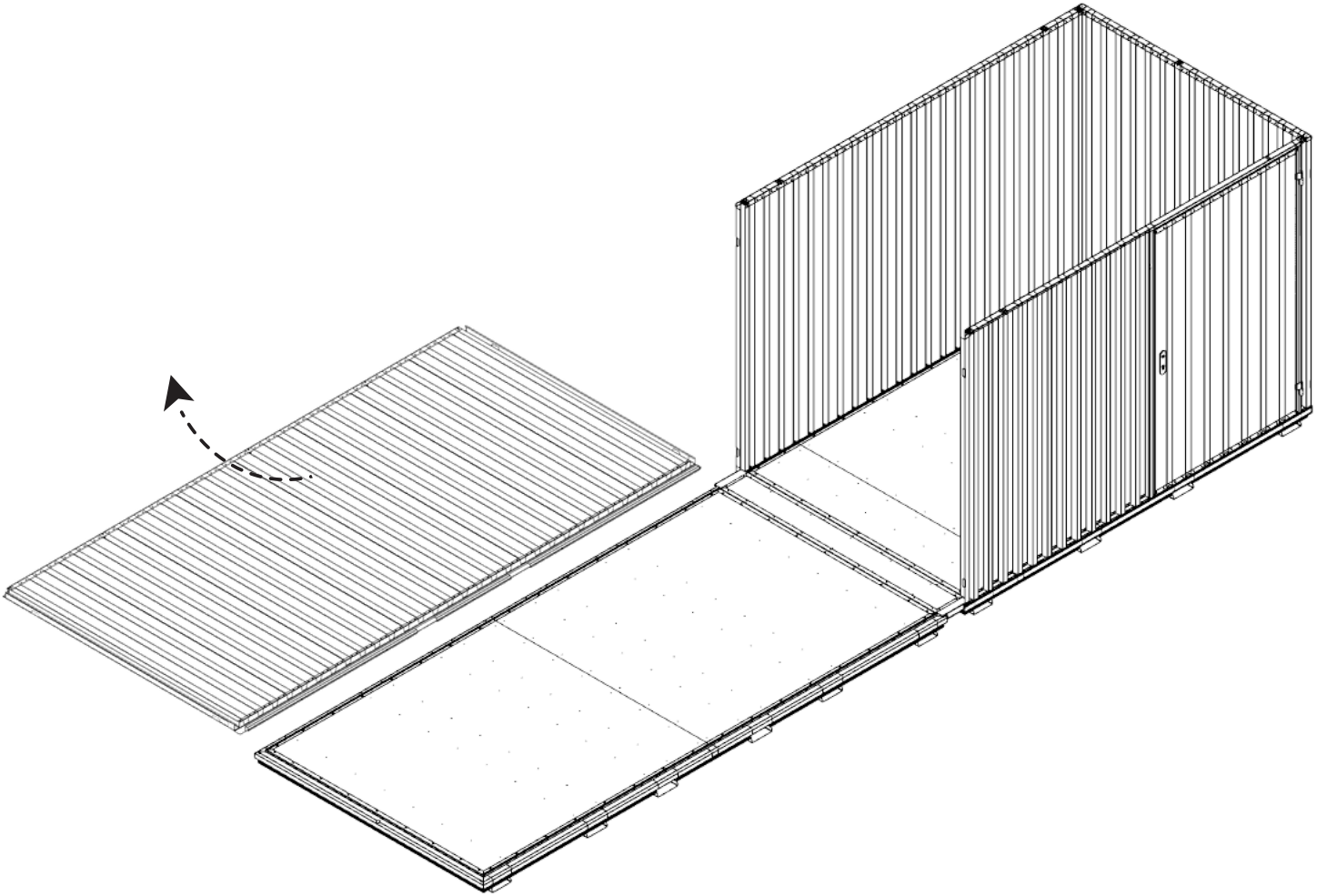

6

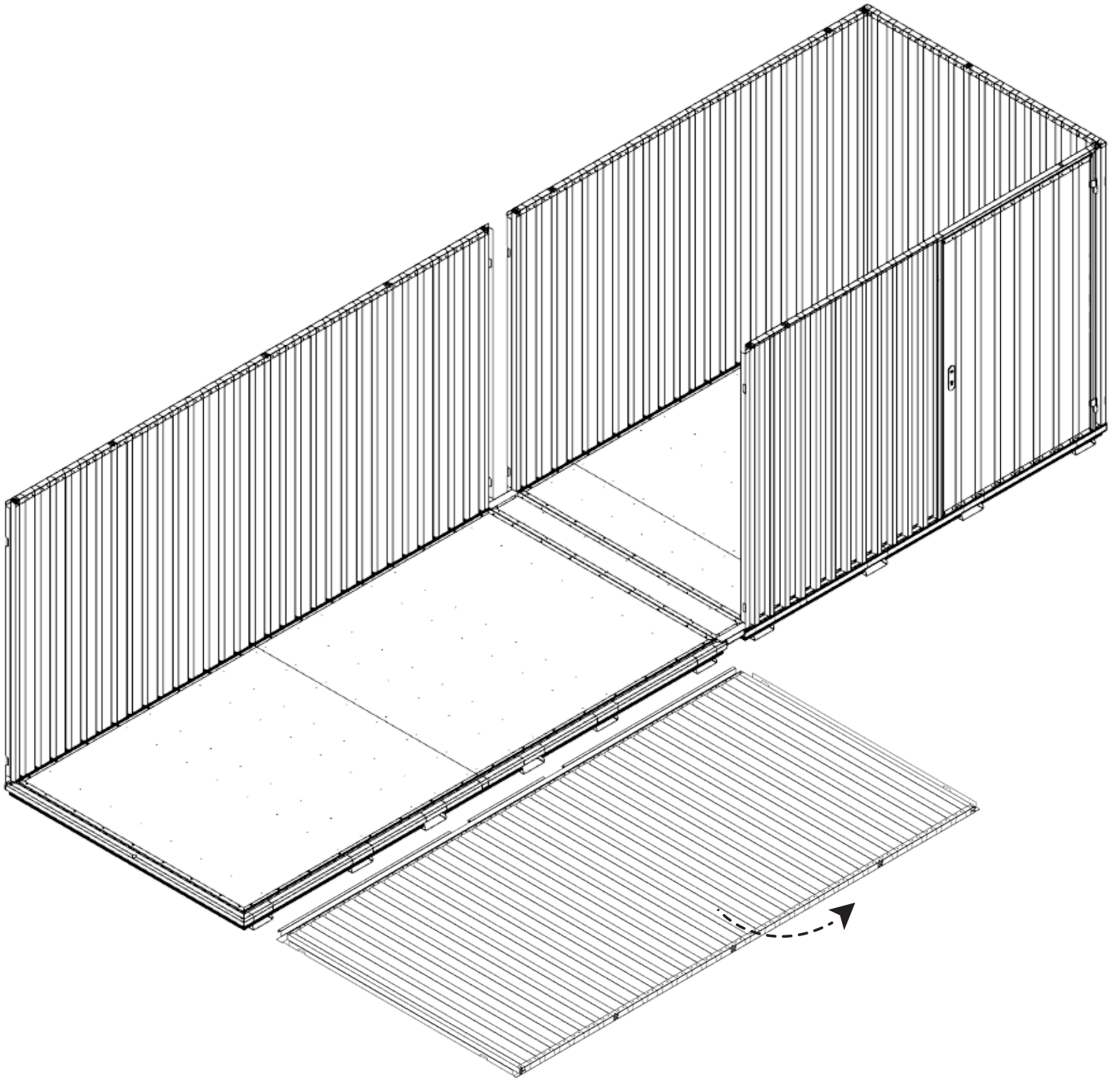

7

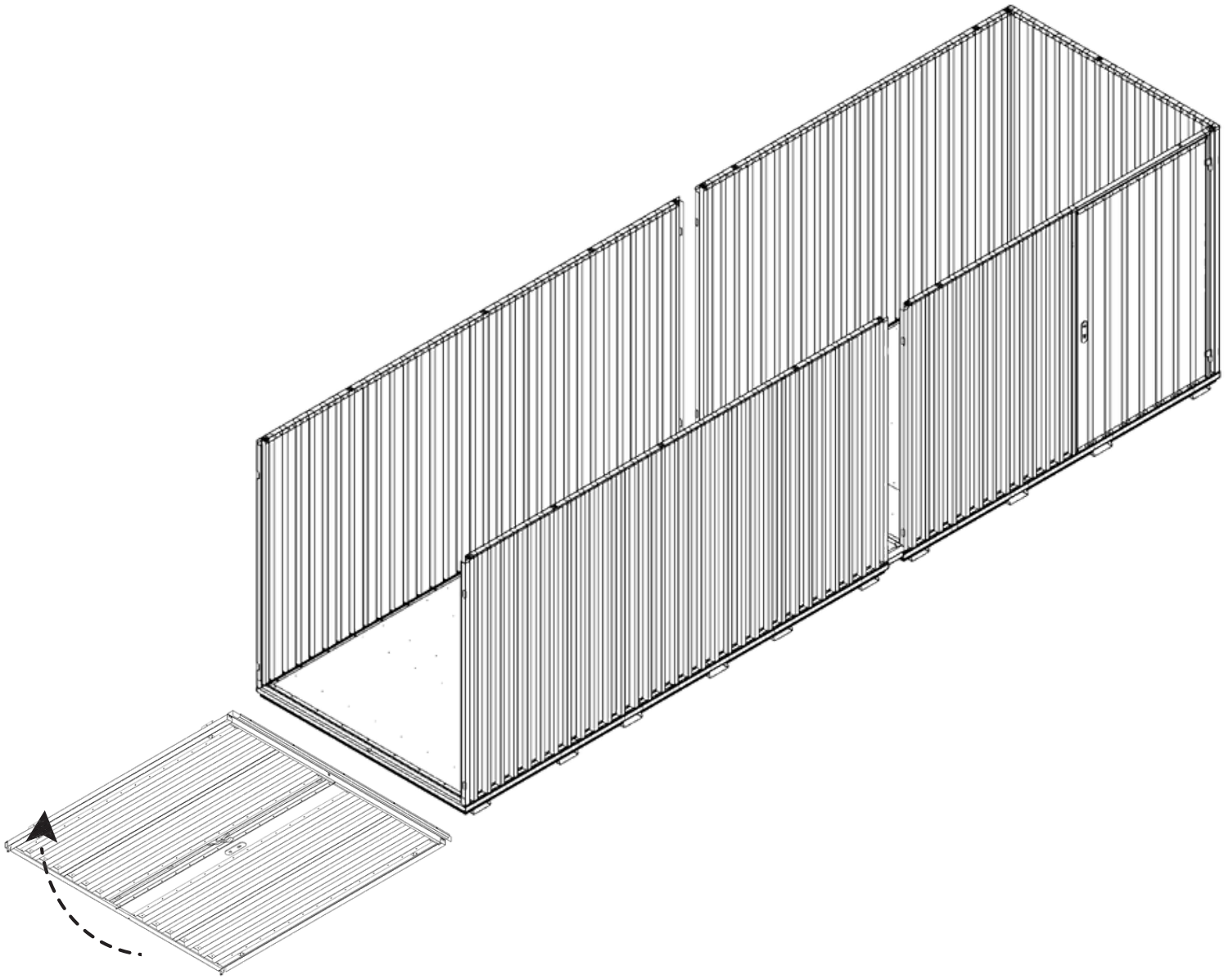

7.1

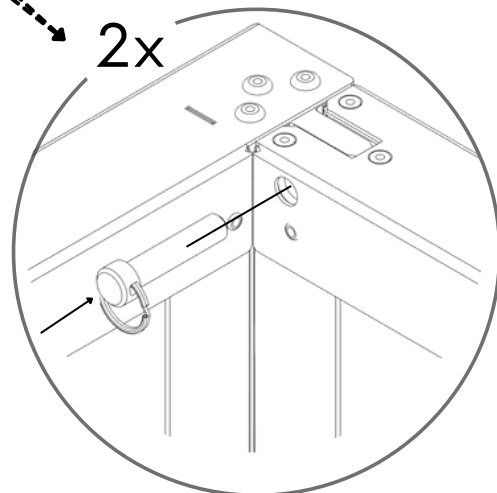
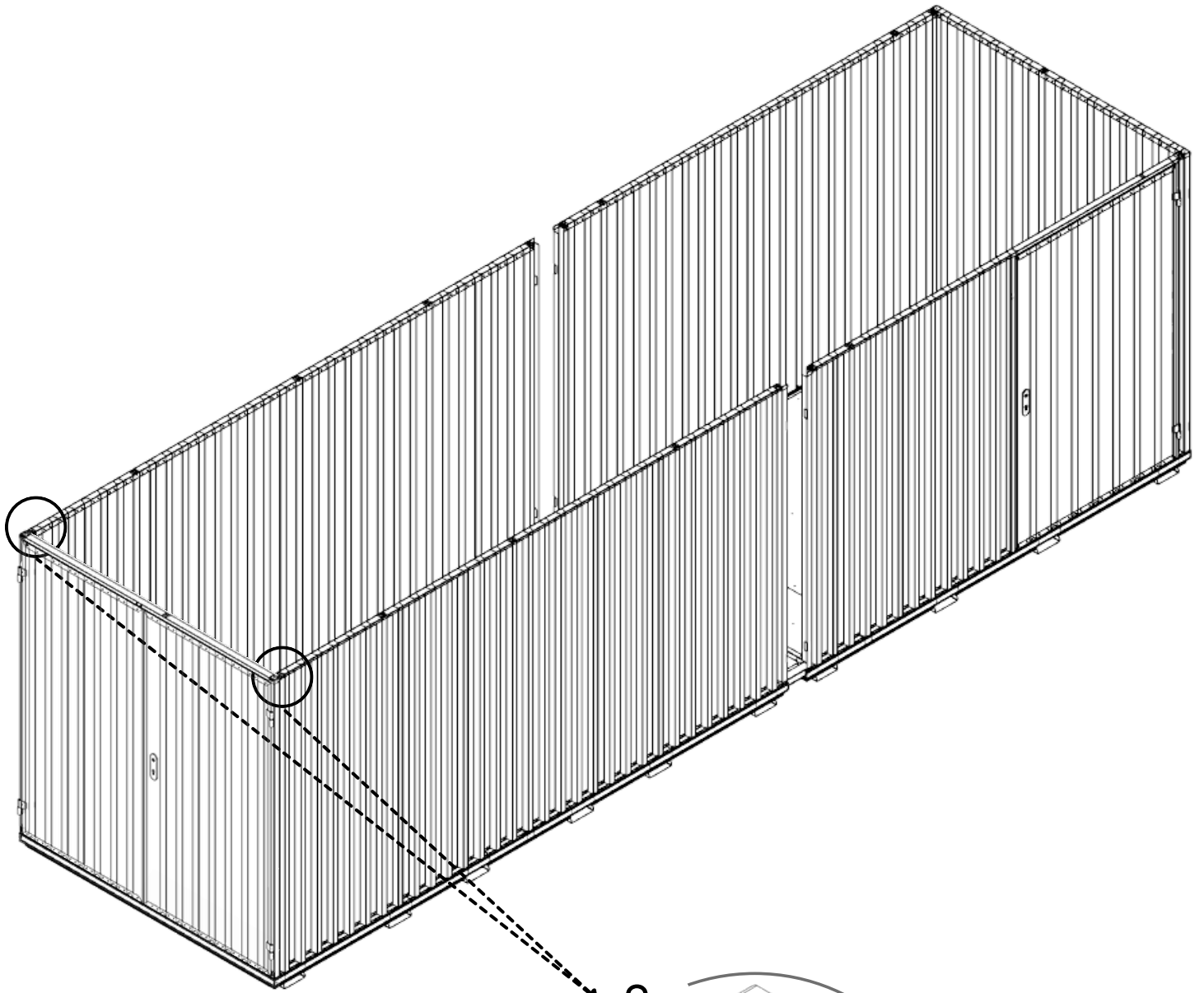

8

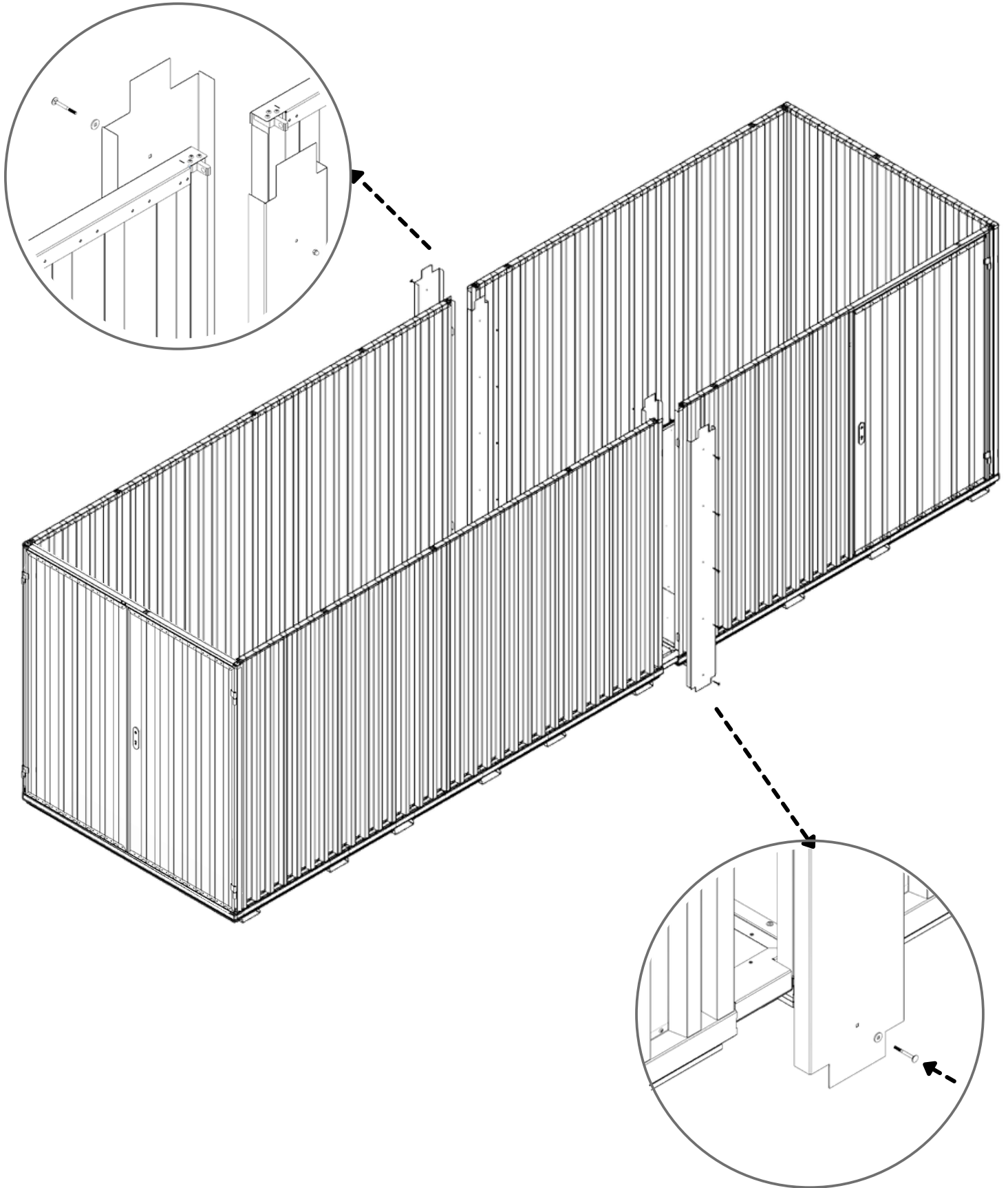

9

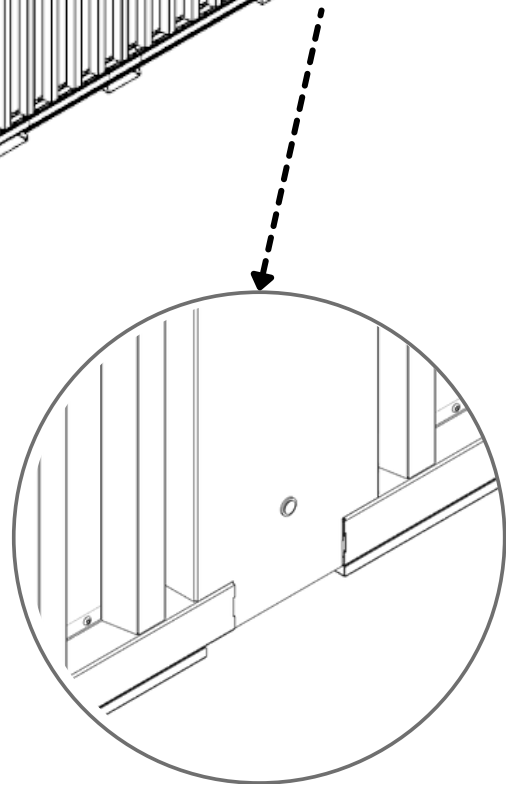
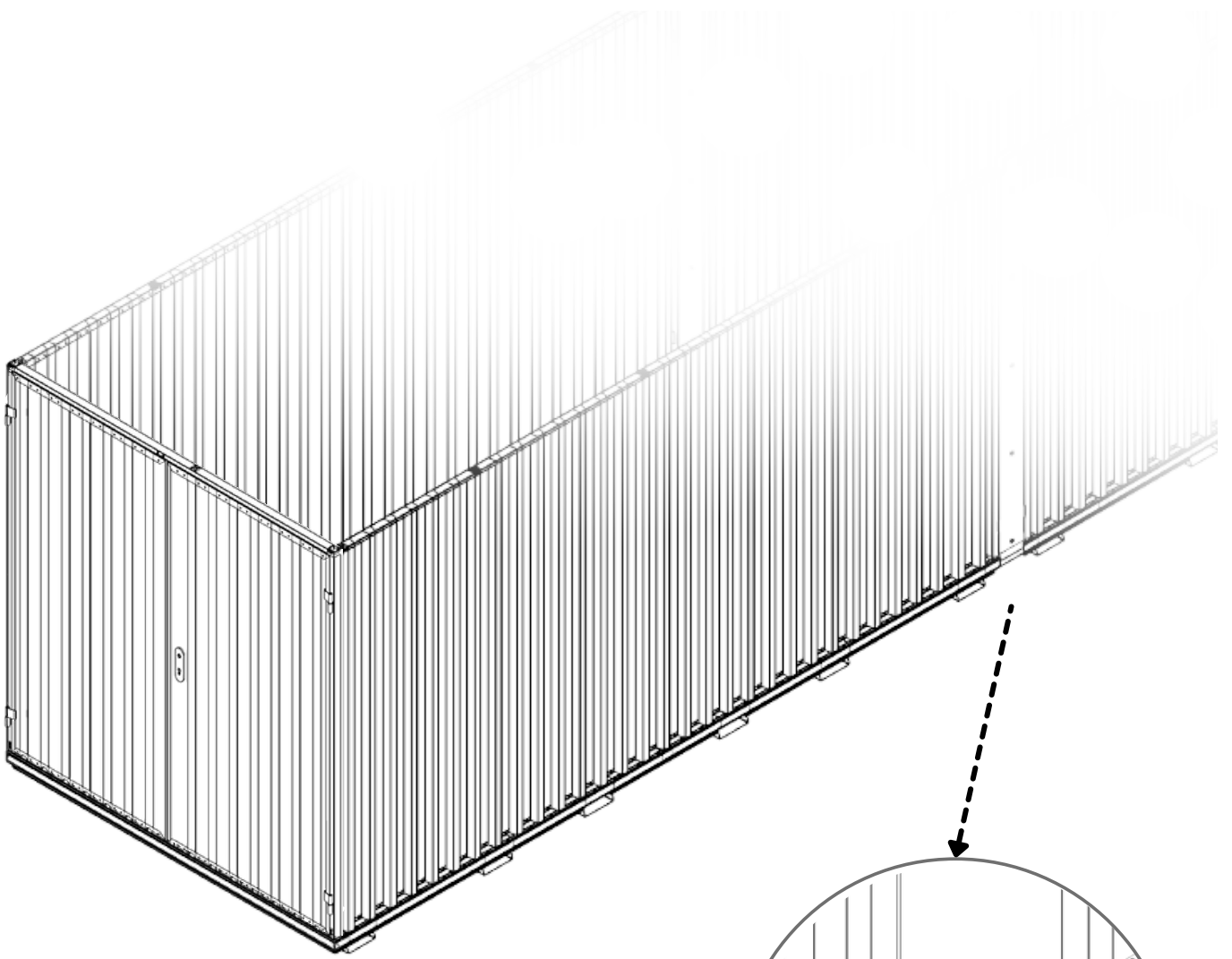



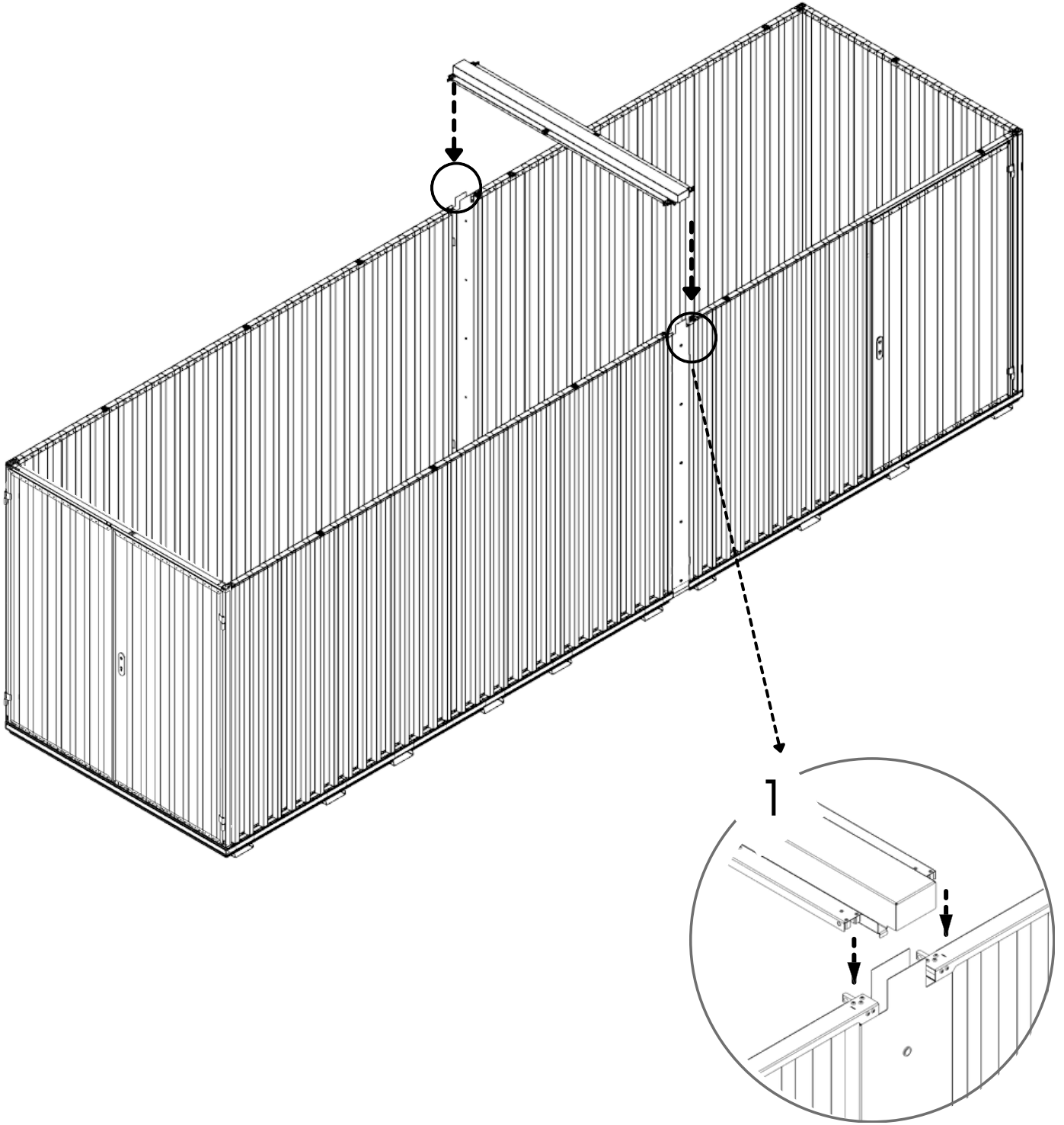

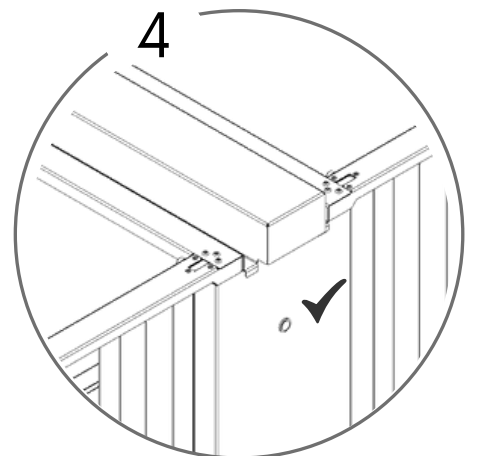
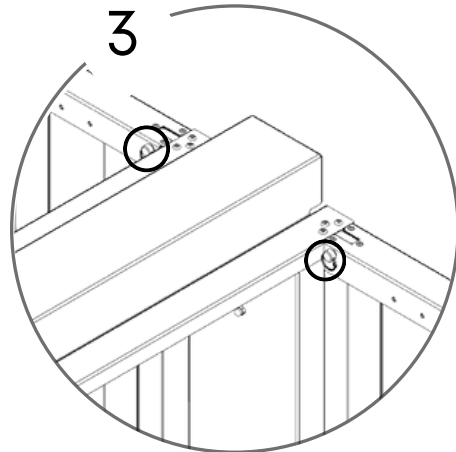
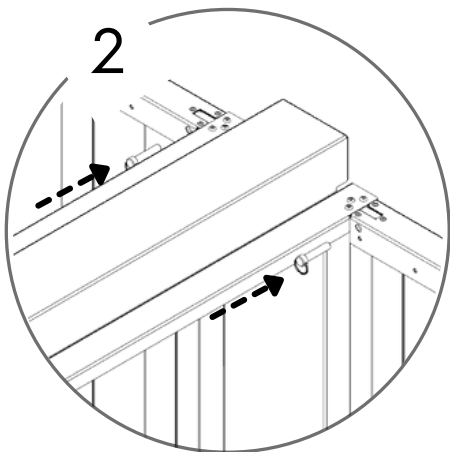
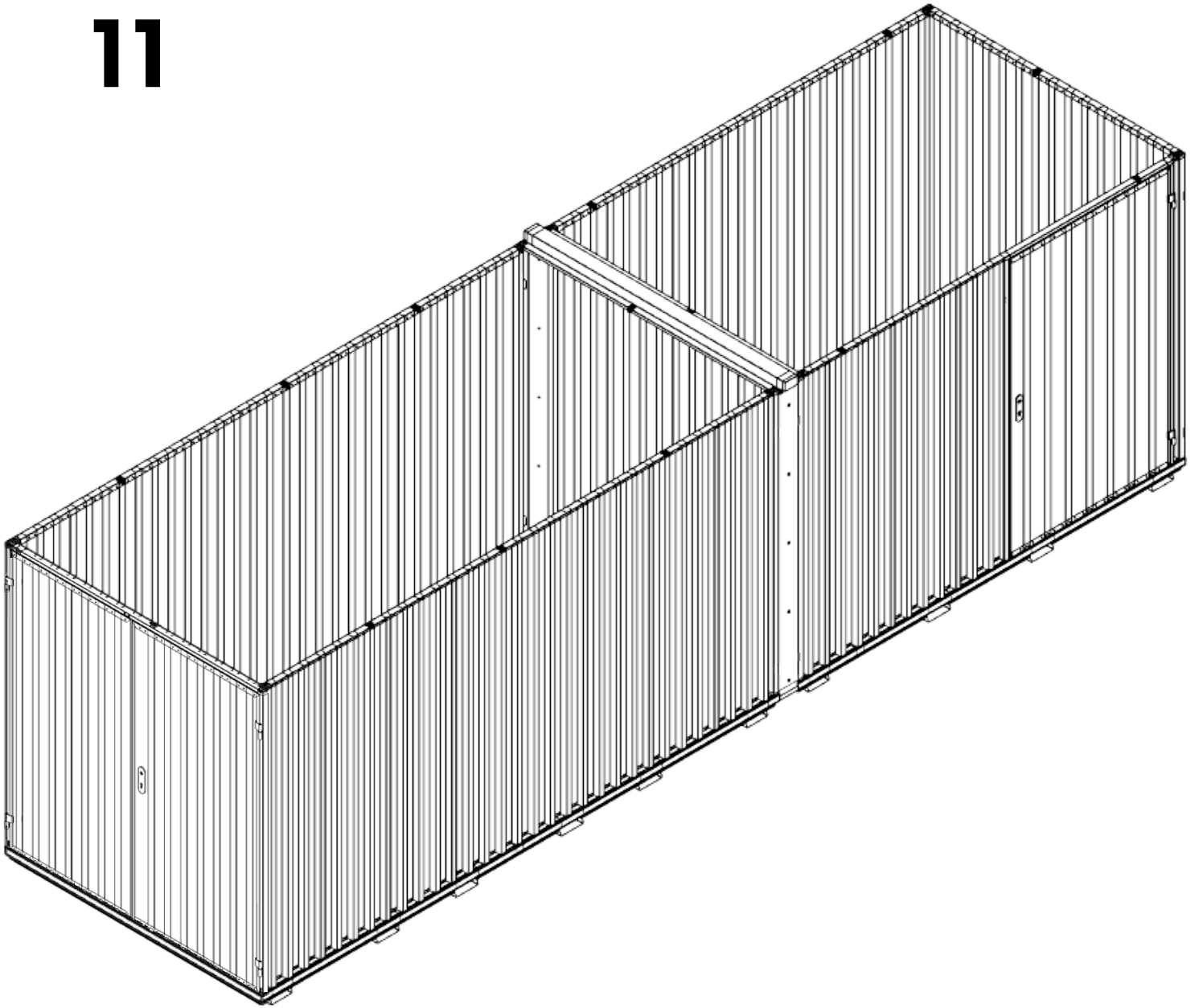

10

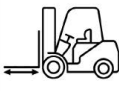

11





 737 KG	 1640 MM	Model Code: 4030.110.440.330 Production Tracking Code:/X09.1.4030.440.330	 9001	 14001	 50001			
---	--	---	---	--	--	---	---	---

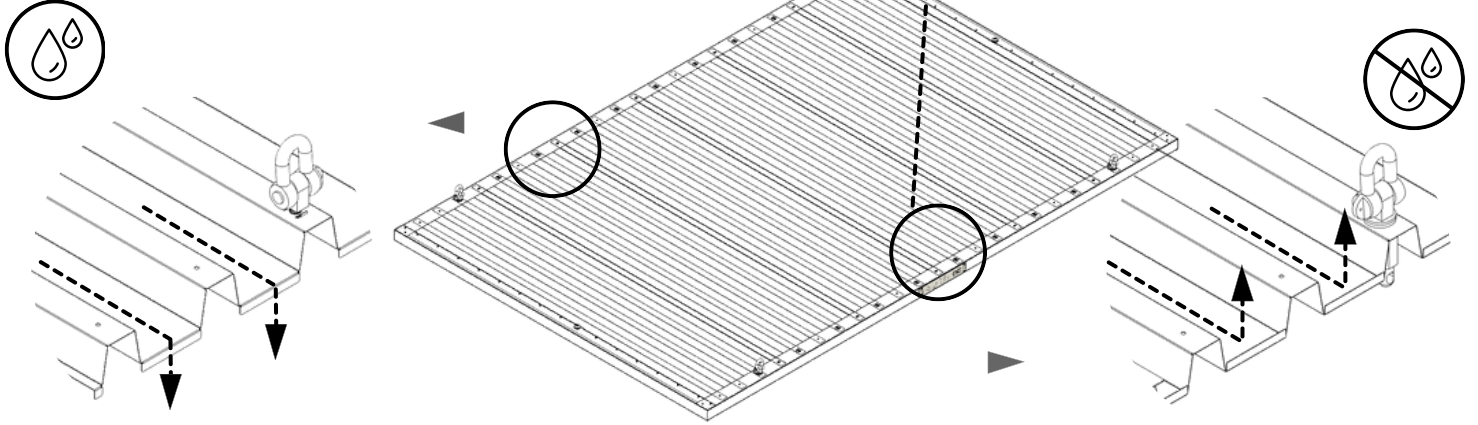

12

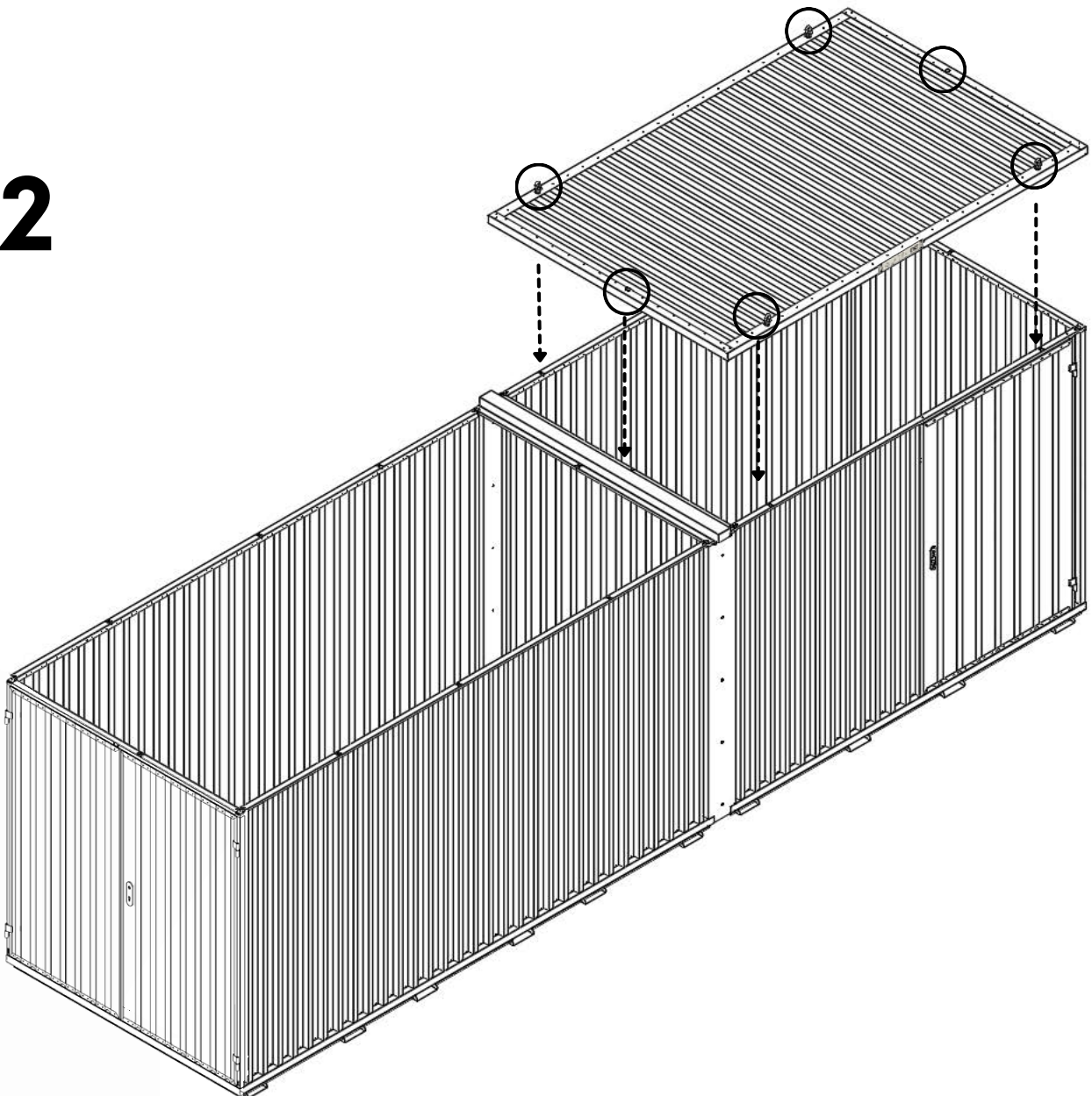

13

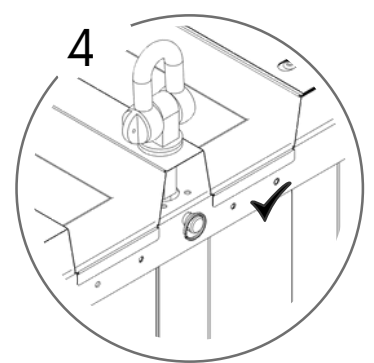
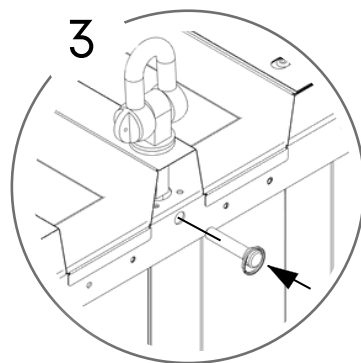
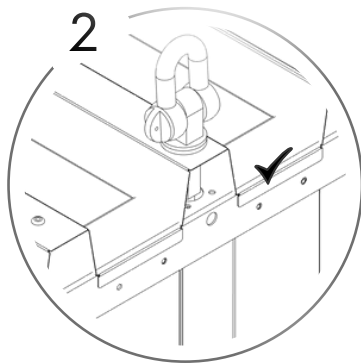
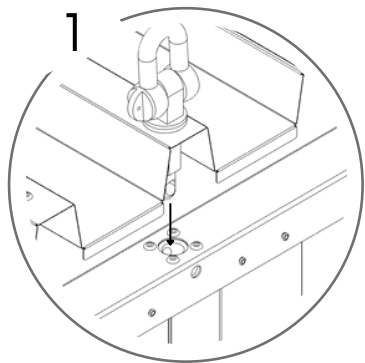
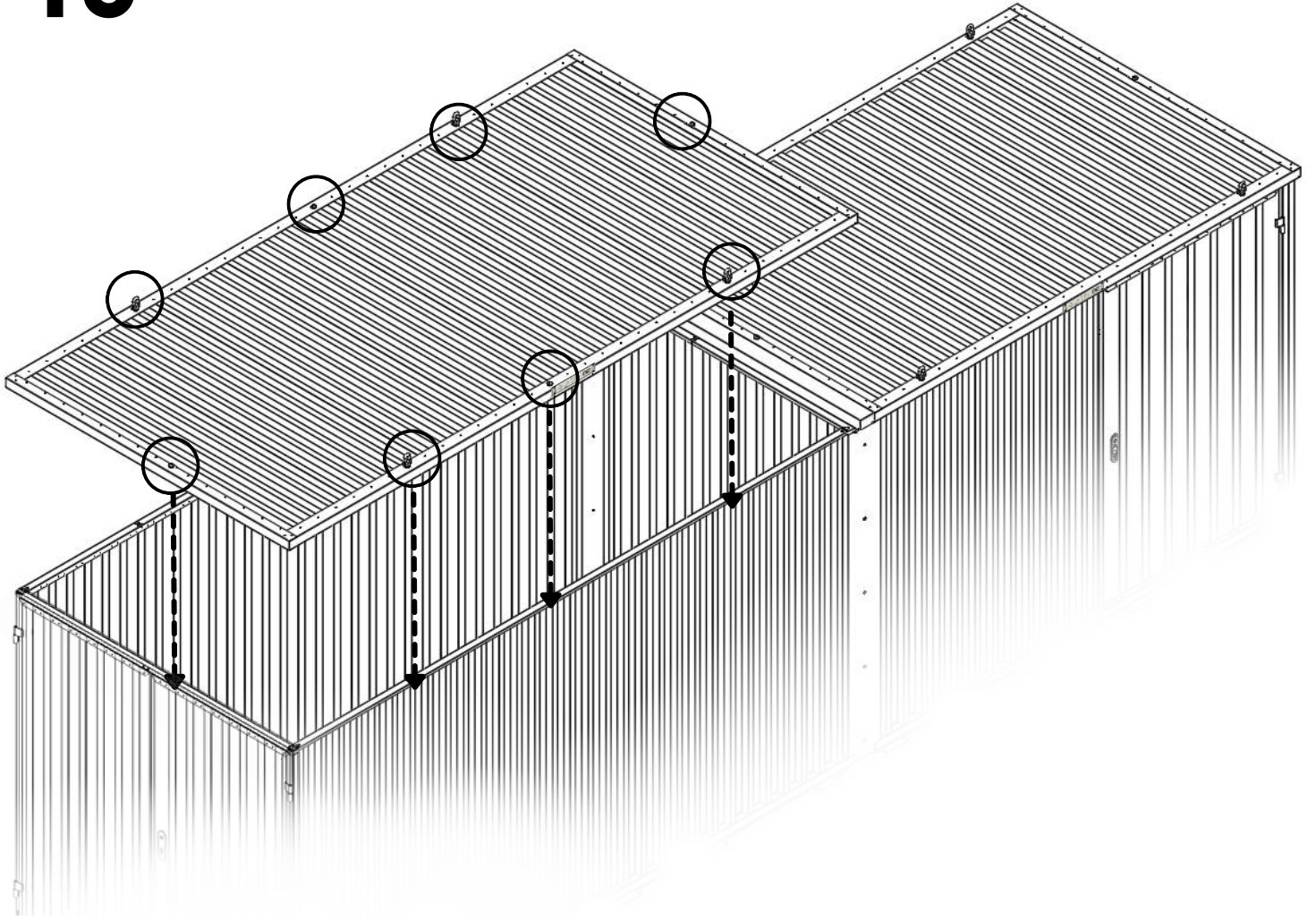

14

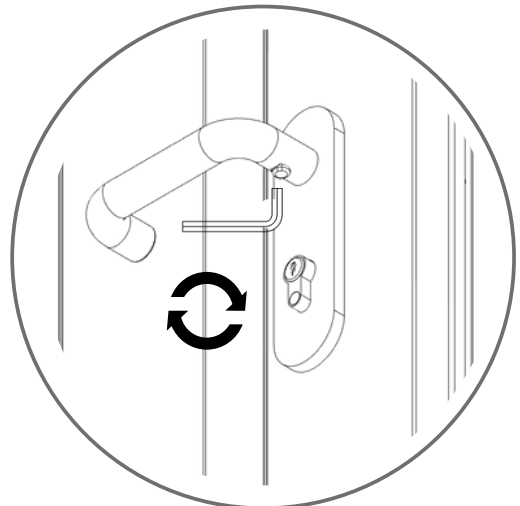
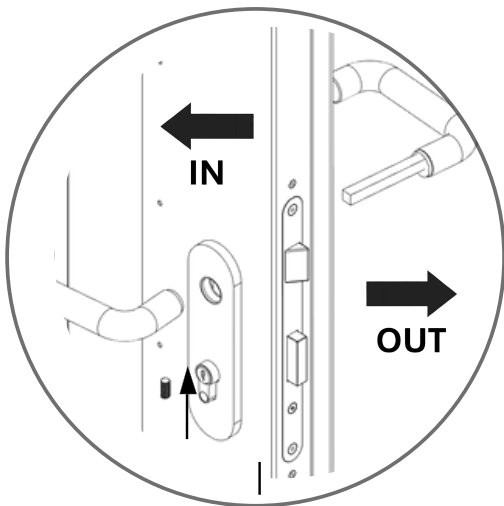
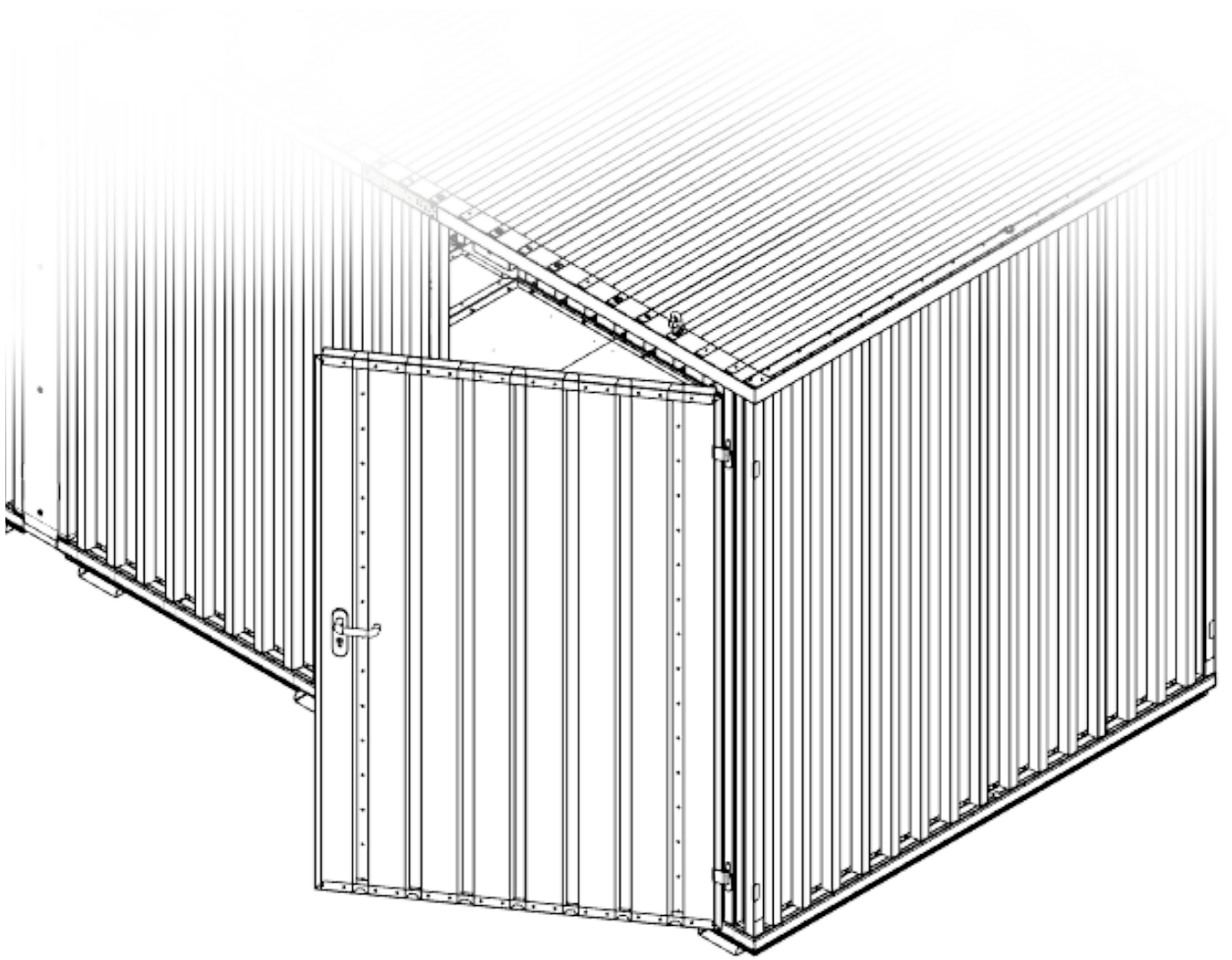

15

